

I.F. PENTODE

Pentode with variable transconductance intended for use as I.F. amplifier in television receivers.

QUICK REFERENCE DATA

Anode current	I_a	12 mA
Transconductance	S	12.5 mA/V
Internal resistance	R_i	500 $k\Omega$

HEATING: Indirect by A. C. or D. C. ; parallel or series supply

Heater voltage	V_f	6.3 V
Heater current	I_f	300 mA

DIMENSIONS AND CONNECTIONS

Dimensions in mm

Base: Noval

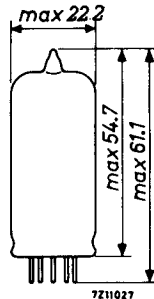
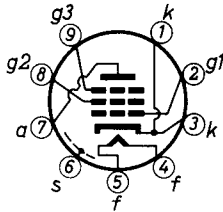

CAPACITANCES

Anode to all except grid No. 1	$C_a(g_1)$	3 pF
Grid No. 1 to all except anode	$C_{g_1(a)}$	9.5 pF
Anode to grid No. 1	C_{ag_1}	max. 0.005 pF
Grid No. 1 to grid No. 2	$C_{g_1g_2}$	2.8 pF

TYPICAL CHARACTERISTICS

Anode voltage	V_a	200 V
Grid No.3 voltage	V_{g3}	0 V
Grid No.2 voltage	V_{g2}	90 V
Grid No.1 voltage	V_{g1}	-2 V
Anode current	I_a	12 mA
Grid No.2 current	I_{g2}	4.5 mA
Transconductance	S	12.5 mA/V
Internal resistance	R_i	500 k Ω
Input resistance grid No.1 (f = 40 MHz)	r_{g1}	13 k Ω
Equivalent noise resistance (f = 40 MHz)	R_{eq}	490 Ω

OPERATING CHARACTERISTICS

Anode voltage	V_a	170	200	230	V			
Grid No.3 voltage	V_{g3}	0	0	0	V			
Grid No.2 supply voltage	V_{bg2}	170	200	230	V			
Grid No.2 resistor	R_{g2}	15	24	39	k Ω			
Grid No.1 voltage	V_{g1}	-1.8	-7.5	-2.0	-9.5	-2.1	-12	V
Anode current	I_a	14	2.7	12	2.7	10.5	2.4	mA
Transconductance	S	14	0.7	12.5	0.62	10.6	0.5	mA/V

REMARK

Operation with cathode bias resistor and/or screen grid resistor is recommended.

LIMITING VALUES (Design centre rating system)

Anode voltage	V_{a0}	max.	550 V
	V_a	max.	250 V
Anode dissipation	W_a	max.	2.5 W
Grid No.2 voltage	V_{g20}	max.	550 V
	V_{g2}	max.	250 V
Grid No.2 dissipation	W_{g2}	max.	0.65 W
Grid No.1 voltage, negative peak	$-V_{g1p}$	max.	50 V
Cathode current	I_k	max.	20 mA
Cathode to heater voltage	V_{kf}	max.	150 V
Grid No.3 resistor	R_{g3}	max.	50 k Ω
Grid No.1 resistor	R_{g1}	max.	1 M Ω

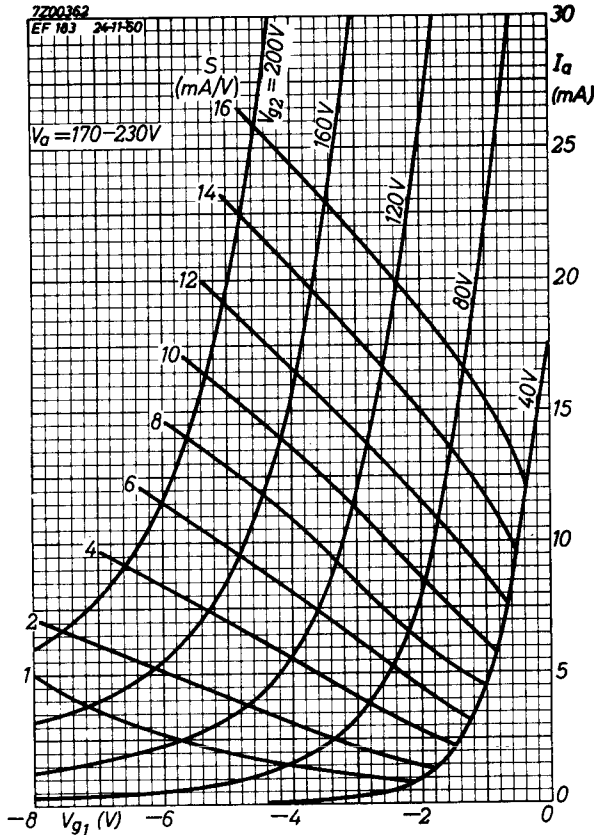

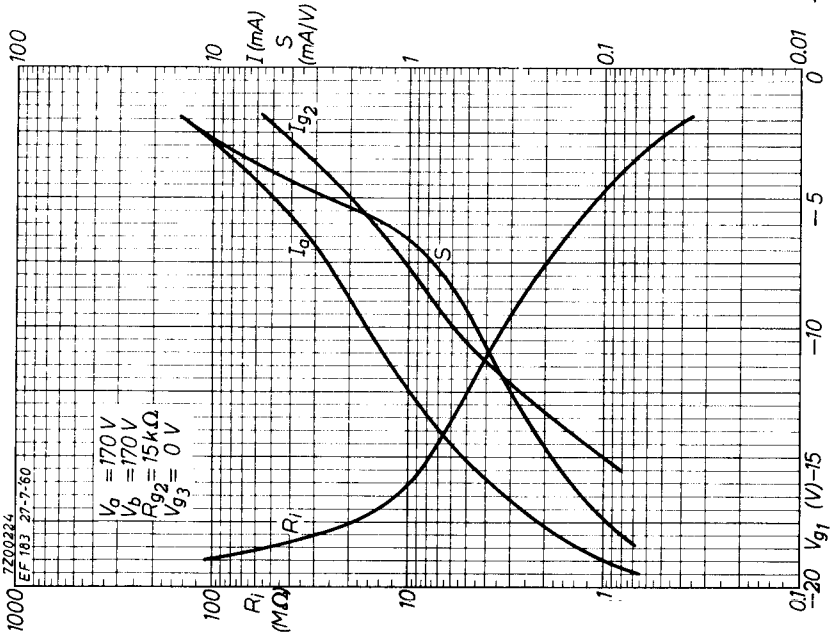
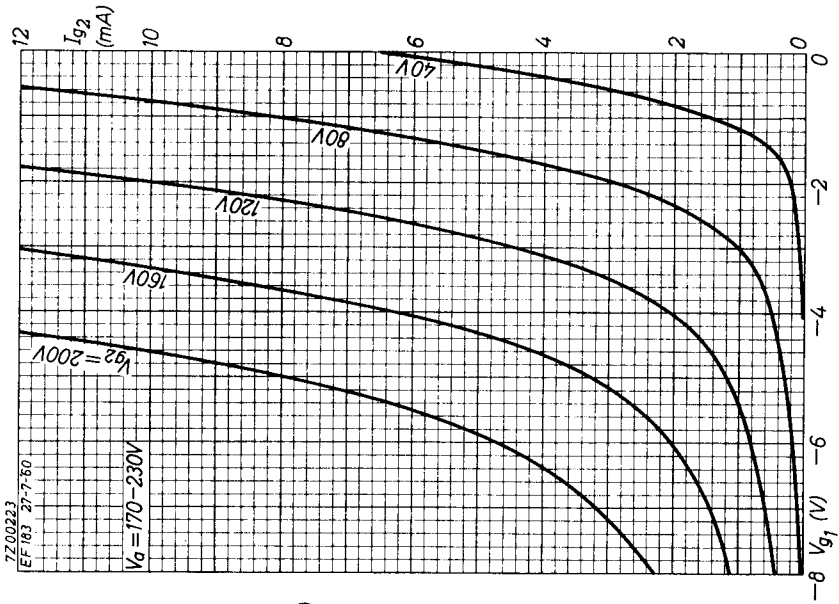

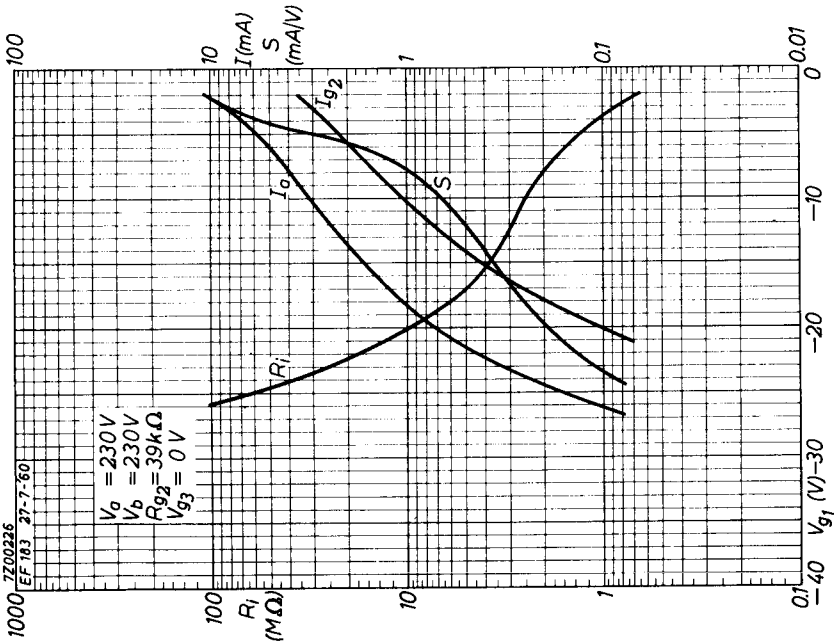
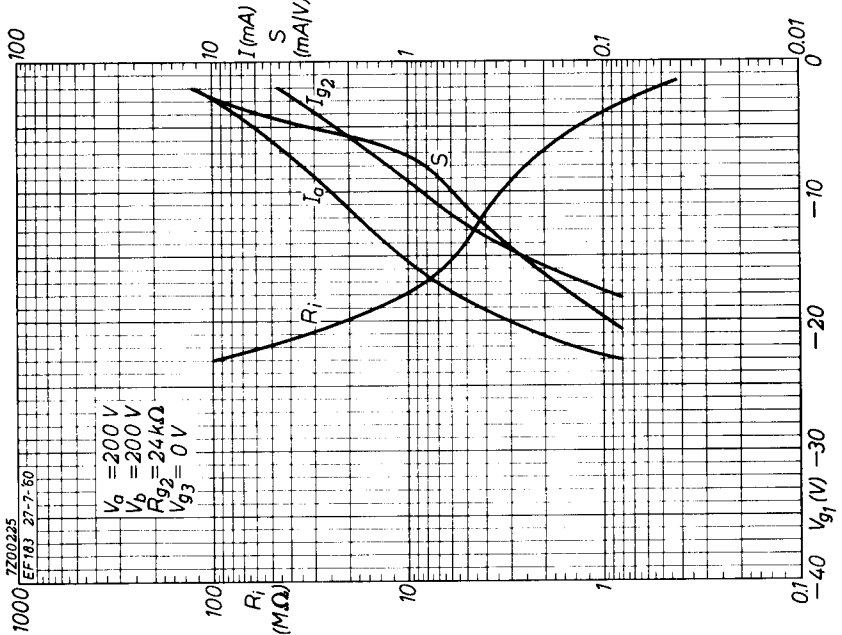

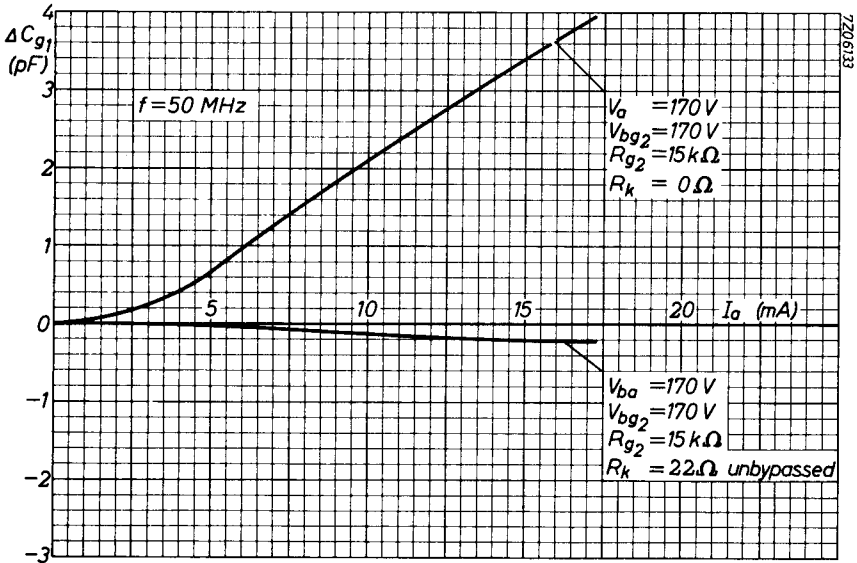
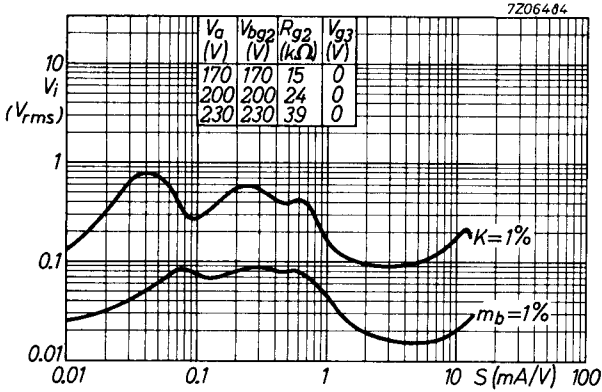

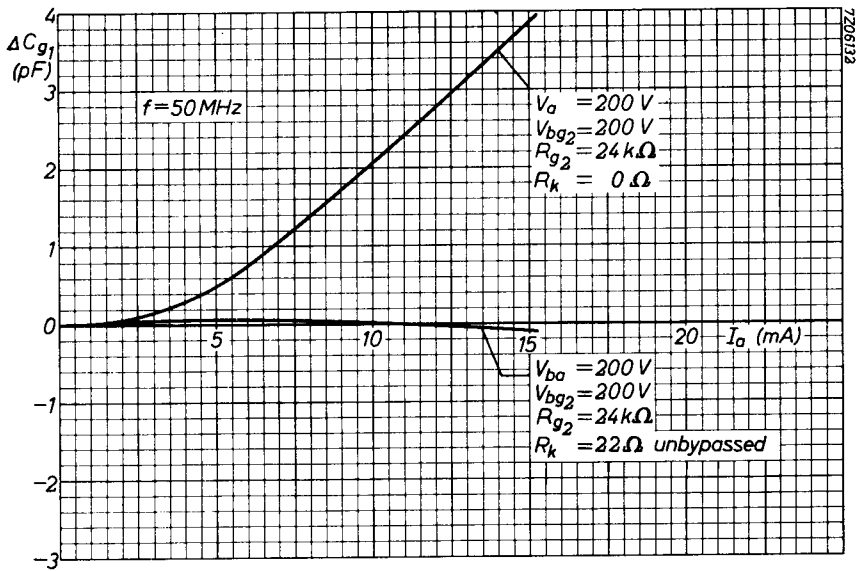

PHILIPS

Data handbook



Electronic
components
and materials

EF183

page	sheet	date
1	1	1970.01
2	2	1970.01
3	3	1970.01
4	4	1970.01
5	5	1970.01
6	6	1970.01
7	7	1970.01
8	FP	1999.08.16