



## MICROPOWER STEP UP LOW VOLTAGE BOOSTER MODULE

### GENERAL DESCRIPTION

The EH4295 Micropower Step Up Low Voltage Booster Module, part of the EH4200 Series of Micropower Step Up Low Voltage Boosters, is a self-powered voltage-booster module that converts a low DC voltage input to a higher AC or DC voltage output suitable for many low-power energy harvesting applications using photodiodes, thermoelectric or electromagnetic generators as the input source. The EH4295 does not need a separate power supply to operate and it derives its power directly from the low input voltage source. The EH4200 Series draws input power levels starting at as low as 2 $\mu$ W, which enables an on-board self-starting oscillator.

The EH4295 features nominal input impedance of 950 $\Omega$ , making it suitable for many different energy generating sources. The EH4200 Series is part of a growing family of Micro-power Low Voltage Booster Modules, Energy Harvesting Modules and Energy Harvesting Integrated Circuits.

The EH4295 is designed primarily for driving loads such as the ALD EH300/EH301 Series Energy Harvesting Modules. The AC outputs of the EH4295 are connected directly to the input terminals of the EH300/EH301 Series Energy Harvesting Modules with a two-wire cable. They can also be used for trickle-charge applications such as battery charger or super-cap charger, including situations where the energy input is not well controlled or regulated. For certain applications, the EH4295 can also be used without the EH300/EH301 Series Energy Harvesting Modules.

The EH4295 self-starting oscillator oscillates at a natural frequency of about 400Hz, which depends on the source impedance, the source voltage, the loading at the output and the resonating components on board the EH4295. The oscillator waveform is coupled to a transformer inside the module that provides an AC output signal that is limited in amplitude by the output loading. A typical output loading is a full wave rectifier that can handle AC inputs over 20V and input power as limited by the output of the EH4295.

For many energy-harvesting applications, the EH4295, combined with EH300 Series Energy Harvesting Modules, offers a simple and efficient solution when used with a low-voltage low-energy generating source that only delivers sporadic intermittent amounts of input power. The combined EH4295 and EH300 Series Modules can ramp from zero output power to useable levels for operating

### FEATURES

- Nominal input impedance of 950 $\Omega$  @  $V_{IN}=0.25V$
- Small footprint and volume less than 1 cu. in.
- Simple and easy to use - just connect a 2-wire input source and 2-wire output load
- Ready-to-Use out of the box, no circuit design required
- Direct interface to ALD's EH300/EH301 series of Energy Harvesting Modules
- A range of models suitable for a variety of energy generating sources
- Self-starting at both very low operating voltage and low operating current levels
- Self-contained booster with all components on-board
- Built-in on-board miniature transformer for high-efficiency energy conversion
- Unique custom on-board EPAD<sup>®</sup> MOSFET arrays
- Optional user-installed full wave rectifier on board to produce DC voltages
- Compatible with a wide range of voltage sources and a wide range of source impedances
- Adaptable for use with a broad range of applications
- No calibration or setup required
- Maintenance free operation
- Long operating life
- Virtually unlimited operating cycles
- Moisture and dust protection
- RoHS compliant

### APPLICATIONS

- Charge EH300/EH301/EH300A/EH301A series EH Modules from low voltage sources
- Energy Harvesting from low-voltage micro-power energy-generating sources
- Direct or Indirect remote-node power supplies for Wireless Sensor Networks
- Low duty-cycle metering, control and sensing networks
- Energy capture from Intermittent energy sources
- Trickle-charger for Standby backup power such as battery-packs or super-capacitor networks
- Backup power for switching between different power sources
- Industrial and Business systems with always-charged temporary backup power supplies
- Micro-power Self-boosting oscillator
- Low DC Voltage Booster to supply operating voltage for another Step-up DC-DC converter
- Extreme life-span power sources
- EH energy capture, storage, and power management from mechanical, thermal, chemical, solar, biological, and human body sources
- EH based battery substitution and/or remote battery charging systems
- Hybrid or alternative power source conditioning
- Condition-based monitoring systems
- Self-powered remote control switching systems
- Hybrid power (dual power) systems with extended operating lives
- System power reliability enhancement
- Intermittent duty cycle remote site applications

### ORDERING INFORMATION

Part Number	Description
EH4295	Micropower Step Up Low Voltage Booster Module, 950 $\Omega$ Input
EJH3C	6 in. Input Cable for EH4200 Series Modules
EJH4C	6 in. Output Cable for EH4200 Series Modules with connector to the EH300/EH301
EJH5C	6 in. Output Cable for EH4200 Series Modules

many remote sensor networks and circuits requiring DC supply voltages in the 1.8V to 6.8V range. The boosted AC or DC output voltage levels can also be used to generate a reference DC output to drive or to initiate other electronic circuits such as external Power Step-up DC-DC converters requiring DC supply voltages over 1.0V in order to operate.

## ENERGY HARVESTING APPLICATIONS

Featuring micro-power and highly efficient operation, the EH4295 is well suited for many EH applications that operate on low-voltage power supply or battery sources at low power levels. The EH4295 is designed to accommodate a voltage input source that changes in voltage and internal impedance similar to that of an EH energy generator source, such as a single-cell photovoltaic cell or a low voltage thermoelectric generator (TEG).

When input energy to an EH energy-generator source is at zero, a typical DC output of the energy generator source is at a voltage that corresponds to a zero energy output state. The corresponding output power of the energy-generator source is also at zero. As external energy builds up at the energy-generator source, the DC voltage at its output starts to rise from its previous state, its internal impedance changes, and it starts to output current as well. When coupled to the EH4295, the energy-generator source internal impedance and the EH4295 input impedance form a network where the energy-generator source starts to deliver power to the EH4295. As soon as the internal oscillation threshold power level is reached, oscillation begins, and energy transfer is initiated. Typically this power level is less than 5 $\mu$ W for the EH4295, and varies across different models and units. Hence the EH4295 is excellent for high efficiency, low power applications where the minimum operating power range are very low, and where otherwise wasted energy cannot be captured and stored in a battery pack or capacitor storage bank using other means.

As input energy builds up at the energy-generator source, the amount of power transferred also changes accordingly. The maximum power rating of the EH4295 limits its power handling capability, but it does allow an external secondary DC-DC converter to take over at some higher power point. The AC output generated by the on-board oscillator enables the EH4295 to support other switching circuits to convert at a higher voltage and power level.

## FUNCTIONAL DESCRIPTION

The EH4295 Micropower Step Up Low Voltage Booster Module is a simple but sophisticated development that thrives on ultra low power operation as well as ultra low voltage operation. At its core is an ALD EPAD<sup>®</sup> MOSFET array that is designed and developed for this application. An on-board transformer that couples to a dedicated EPAD MOSFET Array forms the heart of the self-starting oscillation circuit.

An input decoupling capacitor integrates and filters the input signal to drive the transformer primary winding core. An input ground voltage also turns on an EPAD MOSFET Array through the connection of a resistor to its Gate Input. A current flows through the primary winding of the transformer, coupling and developing a corresponding current in the secondary winding. Upon being energized, a voltage develops across the secondary winding of the transformer. A small coupling resistor-capacitor network then provides negative feedback from the secondary winding to drive the EPAD MOSFET to an 'off' state. This RC network then charges the gate voltage of the EPAD MOSFET until it is again in an 'on' state. Once the EPAD MOSFET is turned on again, the cycle repeats itself and the circuit oscillates at a frequency that is determined by the source generator impedance characteristics, the output loading characteristics, the parameters of the RC network, the characteristics of the EPAD MOSFET array and that of the transformer. This 'natural' frequency also varies with varying input source impedance and the input voltages at the source as well as the changing output characteristics of the output loading.

The EH4295 module is self-starting, and begins operating as soon as enough energy is available for the oscillator to start oscillating. This minimum self-starting energy level may vary slightly from unit to unit. However, it starts boosting voltages at such a low energy level that it generally can capture very low levels of energy spurts before many other industry low-voltage booster modules would begin to function. For select members of the EH4200 MLVB Series of Modules, the oscillator can initiate oscillation at less than 1 $\mu$ W average input power.

The EH4295 primary output is an AC output, which delivers the output waveforms of the oscillator. This AC output can be connected directly to the inputs of an EH300 Series Energy Harvesting Module through a 2-wire connection.

While the primary intent of the EH4295 is to charge ALD's EH300/ EH301 Energy Harvesting Modules, an optional bridge rectifier can be added on the pcb of the module by the user to produce a full-wave rectified DC output. The output of the full-wave rectifier can be used to drive an output DC load and can be useful as a trickle charger for rechargeable batteries or super-cap capacitor banks. This DC output can also be used to power an electronic circuit directly, which requires that a compatible current consumption be designed for the electronic circuit.

## OPTIONAL PARTS LIST

- Full wave rectifier - MBS Series
- Socket Adapter:
  - Hirose DF13-2S
  - Hirose DF13-4S

## ABSOLUTE MAXIMUM and MINIMUM RATINGS

Max. input voltage	_____	+4V
Max. input current	_____	50mA
Max. input power	_____	250 mW
Operating temperature range	_____	0°C to +70°C
Max. output voltage	_____	+12V

**CAUTION:** ESD Sensitive Device. Use static control procedures in ESD controlled environment.

## OPERATING ELECTRICAL CHARACTERISTICS

T<sub>A</sub> = 25°C V<sub>IN</sub> = 0.25V unless otherwise specified

Parameter	Symbol	EH4295			Unit	Test Conditions
		Min	Typ	Max		
Input Power	P <sub>IN</sub>		65		μW	
Input Impedance	R <sub>IN</sub>		950		Ω	
Min. Startup Input Voltage	V <sub>INS</sub>		60		mV	V <sub>OUT</sub> = 4.0V
Min. Operating Input Voltage	V <sub>INMIN</sub>		60		mV	V <sub>OUT</sub> = 4.0V
Input Current	I <sub>IN</sub>		260		μA	
Power Efficiency	η		48		%	
Output Voltage (peak to peak)	V <sub>OUT</sub>		12	15	V	
Min. Output Voltage	V <sub>OUTMIN</sub>	6.0			V	
Min. Operating Input Power	P <sub>INMIN</sub>		2		μW	V <sub>IN</sub> = 0.06V
Max. Input Voltage	V <sub>INMAX</sub>		3	4	V	
Max. Input Current	I <sub>INMAX</sub>		15		mA	
Max. Input Power	P <sub>INMAX</sub>			250	mW	
Max. Power Efficiency	η <sub>MAX</sub>		60		%	V <sub>IN</sub> = 0.75V
Operating Temperature		0		70	°C	
Oscillator Frequency			400		Hz	
DC-DC Voltage Gain	$\frac{V_{OUT}}{V_{IN}}$		90		V/V	

### ENVIRONMENTAL SPECIFICATIONS

- Leadfree (ROHS) compliant
- Operating Temperature Range: 0 to 70° C
- Storage Temperature: -40 to +85° C
- Humidity: To 90% (no condensation)
- Protection: Conformal and Epoxy coated

### MECHANICAL SPECIFICATIONS

- Outline Dimensions:  
W x L x H: 1.00 in. x 1.50 in. x 0.60 in.  
2.54 cm. x 3.81 cm. x 1.52 cm.
- 4 Mounting Holes: 0.085 in. diameter
- Weight: 0.35 ounce (10 grams) nominal

### TYPICAL CABLE CONNECTIONS

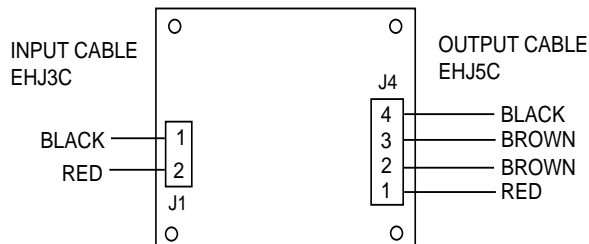
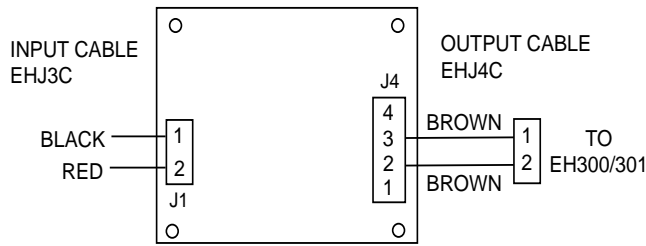

### EH4295 MODULE DIMENSIONS

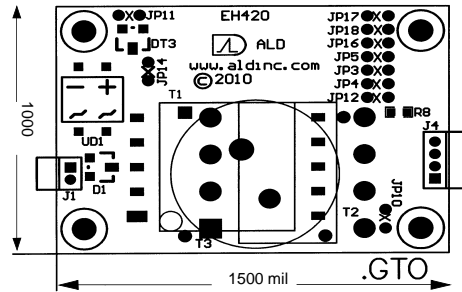

### EH4295 MODULE TOP VIEW

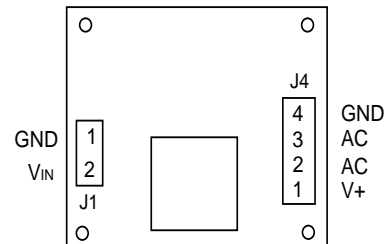

Notes: J1 pin 1: Ground, J1 pin 2: Positive Input  $V_{IN}$   
 J4 pins 2/3: Standard AC Output  
 J4 pins 1/4: DC Output when optional full wave rectifier is installed by user.

### EH4295 CONNECTION TO EH300/301

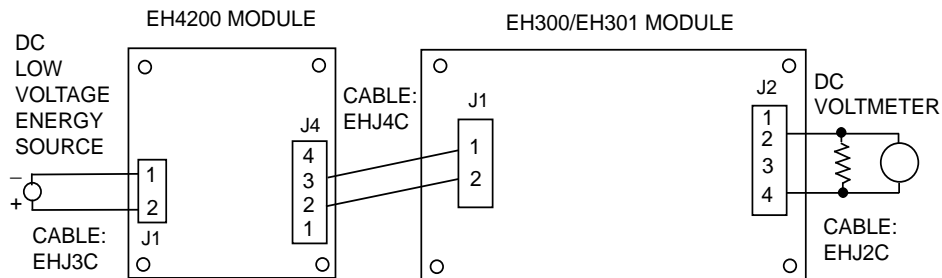

## TYPICAL PERFORMANCE CHARACTERISTICS

**INPUT POWER AS A FUNCTION OF INPUT VOLTAGE**

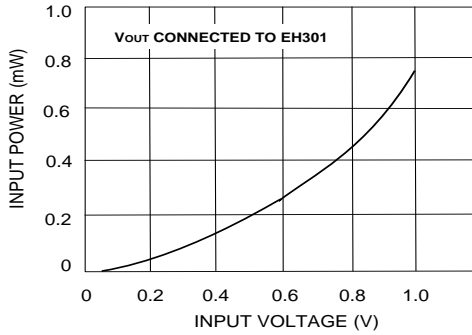

**INPUT POWER AS A FUNCTION OF INPUT VOLTAGE**

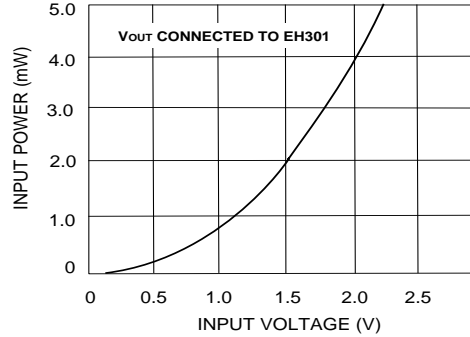

**INPUT CURRENT AS A FUNCTION OF INPUT VOLTAGE**

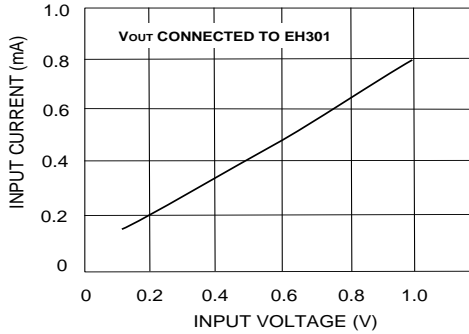

**INPUT CURRENT AS A FUNCTION OF INPUT VOLTAGE**

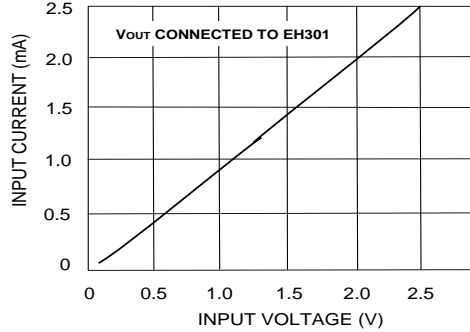

**INPUT IMPEDANCE AS A FUNCTION OF INPUT VOLTAGE**

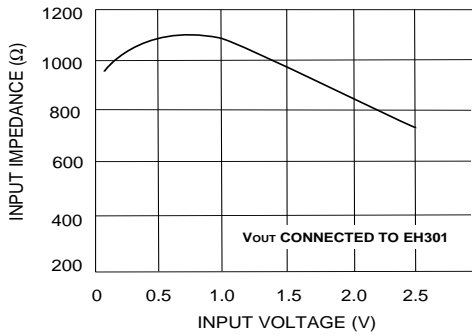

**POWER EFFICIENCY AS A FUNCTION OF INPUT VOLTAGE**

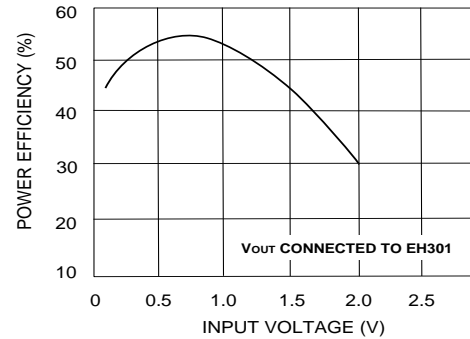

**OUTPUT POWER AS A FUNCTION OF INPUT POWER**

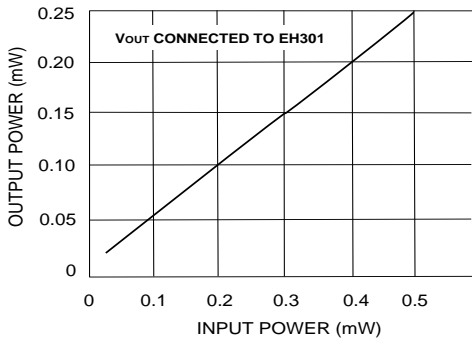

**OUTPUT POWER AS A FUNCTION OF INPUT POWER**

