

EK 2 Octode

The EK 2 is a six-grid frequency-changer, employing the principle of electronic mixing; the small dimensions and particular internal construction of this valve provide the following advantages:

- 1) The electronic coupling effect met with especially on short waves is for the greater part counteracted by a capacitor between the first and fourth grids, the object of this capacitor being to compensate, with a positive capacitance, the apparent negative capacitance produced by electronic coupling.
- 2) Small dimensions and narrow spacing of the electrodes practically eliminates transit-time effects in the range of very short waves.
- 3) The parallel input resistance between control grid and cathode is very high, even on the very short waves, and its effect on the amplification may therefore be ignored.
- 4) Background noise, which is proportional to the root of the anode current divided by the mutual conductance, is only very slight.
- 5) The performance of the valve from the point of view of absence of whistles is extremely good.
- 6) Interference due to cross-modulation or modulation-distortion when control is applied to the valve is a minimum.
- 7) The internal resistance is more than 1 megohm and permits the use of very good quality I. F. circuits, giving a high degree of gain.
- 8) Microphony is so slight that it may be ignored in the design of a receiver.



Fig. 1
Dimensions in mm.

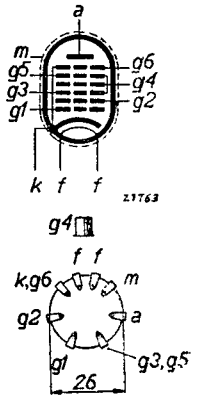

Fig. 2
Arrangement of electrodes and base connections.

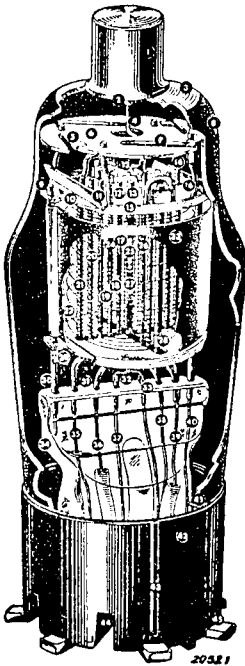

Fig. 3
Construction of the new octode EK 2. The capacitor for the compensation of inductive effect is shown at 12.

HEATER RATINGS

Heating: indirect; A.C. or D.C., series or parallel supply.
 Heater voltage $V_f = 6.3 \text{ V}$
 Heater current $I_f = 0.200 \text{ A}$

CAPACITANCES

- | | |
|---------------------------------|----------------------------------|
| $C_{ag4} < 0.07 \mu\mu\text{F}$ | $C_{g2} = 4.5 \mu\mu\text{F}$ |
| $C_a = 10 \mu\mu\text{F}$ | $C_{g2g4} < 0.25 \mu\mu\text{F}$ |
| $C_{g1} = 6.0 \mu\mu\text{F}$ | $C_{g4} = 8.8 \mu\mu\text{F}$ |
| $C_{g1g4} = 1.1 \mu\mu\text{F}$ | |

OPERATING DATA (for medium- and long-wave operation)

Anode voltage						
$V_a =$	100 V					200—250 V
Screen-grid voltage						
$V_{g_{3,5}} =$	50 V					50 V
Oscillator-anode voltage						
$V_{g_2} =$	100 V					200 V
Oscillator grid leak						
$R_{g_1} =$	50,000 ohms					50,000 ohms
Oscillator voltage, grid 1						
$V_{osc} =$	9 V_{eff}					15 V_{eff}
Oscillator grid current						
$I_{g_1} =$	200 μA					300 μA
Cathode resistor						
$R_k =$	570 ohms					490 ohms
Bias, grid 4						
$V_{g_4} =$	-2 V ¹⁾	-15 V ²⁾	-20 V ³⁾	-2 V ¹⁾	-15 V ²⁾	-20 V ³⁾
Anode current						
$I_a =$	1 mA	—	—	1 mA	—	—
Screen-grid current						
$I_{g_3} + I_{g_5} =$	1 mA	—	—	1.1 mA	—	—
Oscillator-anode current						
$I_{g_2} =$	1.5 mA	—	—	2.5 mA	—	—
Conversion conductance						
$S_c =$	550	5.5	2	550	5.5	2 $\mu A/V$
Internal resistance						
$R_i =$	1.2	> 10	> 10	2	> 10	> 10 M ohms
Conductance, grid 1 with respect to grid 2 ($V_{osc} = 0$)						
$S_{g_1/g_2} =$	0.3 mA/V	—	—	0.4 mA/V	—	—
Direct current, oscillator anode at commencement of oscillation ($V_{osc} = 0$)						
$I_{g_2} =$	3.2 mA	—	—	5.5 mA	—	—

1) Without control

2) Conductance reduced to one-hundredth of uncontrolled value

3) Extreme limit of control

OPERATING DATA (for reception on all wavelengths) ¹⁾

Anode voltage						
V_a ==	100 V					200—250 V
Screen-grid voltage						
$V_{g3,5}$ ==	80 V					80 V
Oscillator-anode voltage						
V_{g2} ==	100 V					200 V
Oscillator grid leak						
R_{g1} ==	16,000 ohms					50,000 ohms
Oscillator voltage, grid 1						
V_{osc} ==	6 V_{eff}					9 V_{eff}
Oscillator grid current						
I_{g1} ==	300 μ A					200 μ A
Cathode resistor						
R_k ==	395 ohms					525 ohms
Bias, grid 4						
V_{g4} ==	-3 V ¹⁾	-26 V ²⁾	-40 V ³⁾	-4 V ¹⁾	-26 V ²⁾	-40 V ³⁾
Anode current						
I_a ==	2.5 mA	—	—	1.7 mA	—	—
Screen-grid current						
$I_{g3} + I_{g5}$ ==	2.8 mA	—	—	1.3 mA	—	—
Oscillator-anode current						
I_{g2} ==	2.3 mA	—	—	4 mA	—	—
Conversion conductance						
S_c == 550 μ A/V	5.5	1	50	5.5	1 μ A/V	
Internal resistance						
R_i ==	0.65	> 10	> 10	1.4	> 10	> 10 M ohms
Conductance grid 1 with respect to grid 2 ($V_{osc} = 0$)						
S_{g1g2} ==	0.35	—	—	0.9	—	— mA/V
Direct current, oscillator anode at commencement of oscillation ($V_{osc} = 0$)						
I_{g2} ==	4 mA	—	—	9 mA	—	—

¹⁾ Without control ²⁾ Conductance reduced to one-hundredth of uncontrolled value ³⁾ Extreme limit of control ⁴⁾ In view of the possibility of frequency drift, the valve should not be controlled in the short-wave range.

MAXIMUM RATINGS

V_{a0} == max. 550 V	W_{g2} == max. 1.3 W
V_a == max. 250 V	I_k == max. 12 mA
W_a == max. 1.0 W	V_{g4} ($I_{g4} = + 0.3 \mu$ A) == max. -1.3 V
$V_{g3,50}$ == max. 550 V	R_{g3k} == max. 2.5 M ohms
$V_{g3,5}$ == max. 125 V	R_{g1k} == max. 100,000 ohms
$W_{g3,5}$ == max. 0.3 W	R_{fk} == max. 5,000 ohms
V_{g20} == max. 550 V	V_{fk} == max. 100 V ¹⁾
V_{g2} == max. 225 V	

¹⁾ Direct voltage or effective value of alternating voltage.

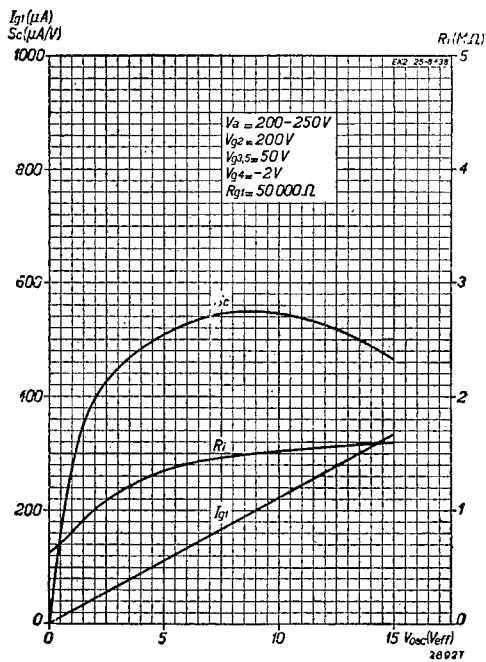

Fig. 4
 Conversion conductance S_c , internal resistance R_i and oscillator-grid current I_{g1} as a function of the oscillator voltage, with $V_{g2} = 200 V$ and $V_{g3,5} = 50 V$.

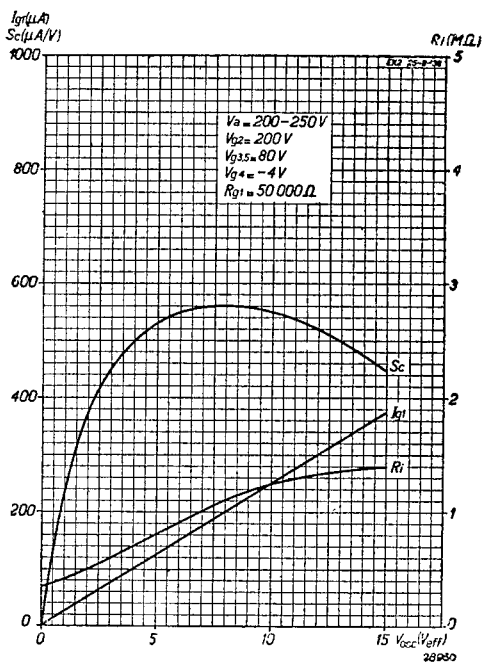

Fig. 5
 Conversion conductance S_c , internal resistance R_i and oscillator-grid current I_{g1} as a function of the oscillator voltage, with $V_{g2} = 200 V$ and $V_{g3,5} = 80 V$.

EK 2

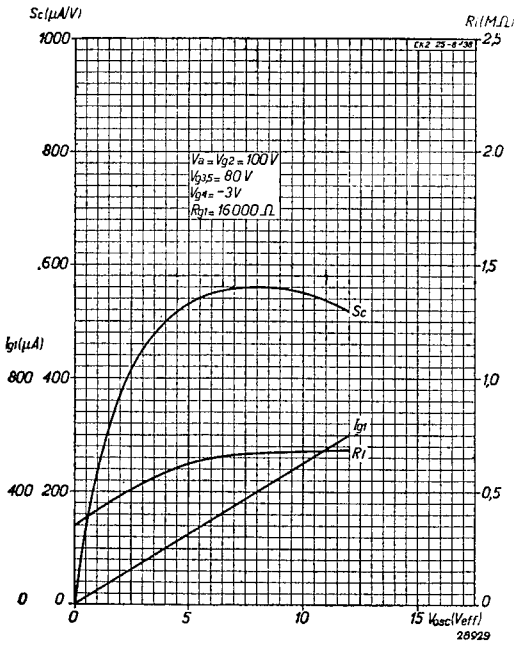

Fig. 6
Conversion conductance S_c , internal resistance R_i and oscillator-grid current I_{g1} as a function of the oscillator voltage, with $V_{g2} = 100\text{ V}$ and $V_{g3,5} = 80\text{ V}$.

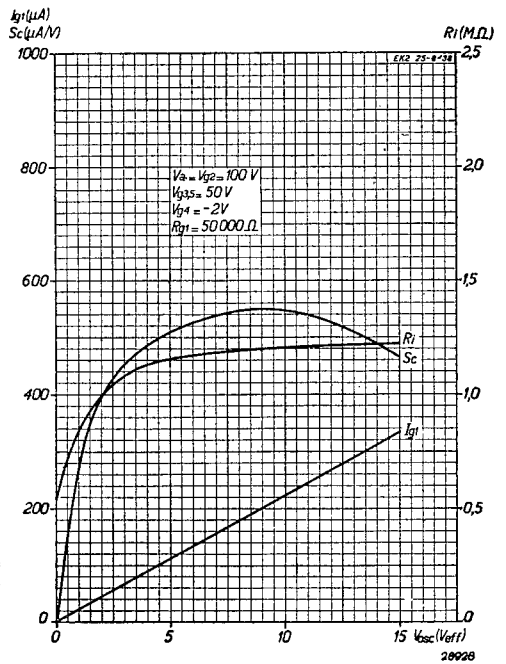

Fig. 7
Conversion conductance S_c , internal resistance R_i and oscillator-grid current I_{g1} as a function of the oscillator voltage, with $V_{g2} = 100\text{ V}$ and $V_{g3,5} = 50\text{ V}$.

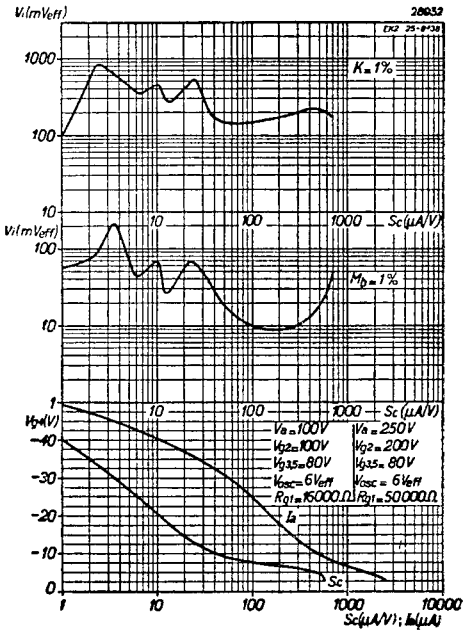

Fig. 8
 Upper diagram. Alternating input voltage as a function of the conversion conductance controlled by the bias on grid 4, with 1% cross-modulation.
 Centre diagram. Alternating input voltage as a function of the conversion conductance controlled by the bias on grid 4, with 1% modulation hum.
 Lower diagram. Anode current and conversion conductance as a function of the bias on grid 4.

The supply for the various electrodes should be derived preferably from a high-value potential-divider network, although, naturally, it is also possible to apply the voltages through series resistors of sufficiently high value. As the oscillator unit functions just as easily without bias (i.e. $V_{g1} = 0$), the grid leak of the EK 2 can be connected directly to the cathode. A value of 15 V_{eff} for the oscillator voltage guarantees efficient working with very little back-ground noise and, in the medium- and long-wave ranges, this value can usually be attained without any difficulty. It is possible, however, that the reaction at 600 metres may need to be so tight that at 200 metres the oscillator voltage would be twice as much and this may tend to cause periodical interruption of the oscillation (squegging).

This effect was formerly met with in simple types of receiver with reaction, manifesting itself as a troublesome variation in reception, or else a host of whistles when the set was being tuned to certain stations, this being actually due to very rapid cessation and re-commencement of the oscillation. Squegging may be prevented by, inter alia, reducing the number of turns on the reaction coil; the oscillator voltage at the upper end of the wave-range will then certainly be slightly lower than normal, but from the characteristic of the conversion conductance as a function of the oscillator voltage (Fig. 4) it will be seen that at about 9 or 10 V_{eff} the slope is even better than at 15 V_{eff} . In order to stabilize the oscillator voltage throughout the whole range a damping resistor is frequently connected in parallel with the coupling coil.

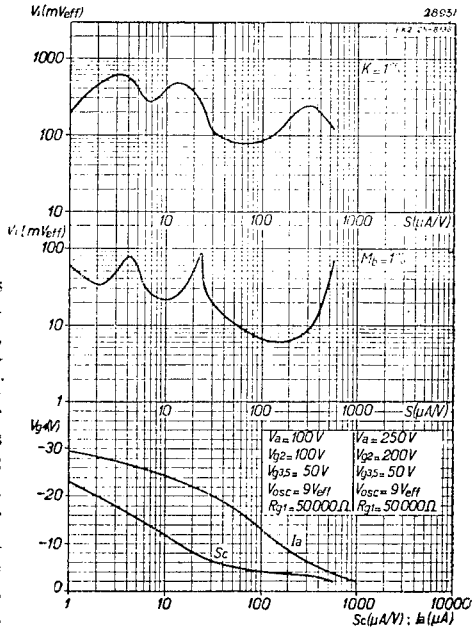

Fig. 9
 Upper diagram. Alternating input voltage as a function of the conversion conductance controlled by the bias on grid 4, with 1% cross-modulation.
 Centre diagram. Alternating input voltage as a function of the conversion conductance with 1% modulation hum.
 Lower diagram. Anode current and conversion conductance as a function of the bias on grid 4.

Another remedy is to employ lower values of grid capacitor and leak for the oscillator section of the valve and this gives excellent results in the short-wave range; satisfactory values are about $50 \mu\mu\text{F}$ for the grid capacitor and 50,000 ohms for the leak. Since $50 \mu\mu\text{F}$ is really too low for good long-wave reception (a value of about 200 to 1000 $\mu\mu\text{F}$ is usually preferred), the value of the grid leak may be reduced in all-wave receivers, instead of using a smaller capacitor, e.g., 10,000 or 16,000 ohms (see also data relevant to the latter value).

At the same time this resistor must not be in parallel with the oscillator circuit, as this damps the latter too much; Fig. 11 illustrates the proper arrangement, whilst Fig. 12 shows a circuit in which a lower value of grid leak is employed with the padding capacitor serving also as grid capacitor; this again results in less damping of the oscillator circuit. If the value of the padding capacitor C_p is too low, however, damping will still occur and in "all-wave" receivers the circuit depicted in Fig. 13 is recommended.

Here a grid leak of 50,000 ohms is used for the broadcast range and 10,000 ohms for the short waves. If a padding capacitor C_p is also to be included on short waves

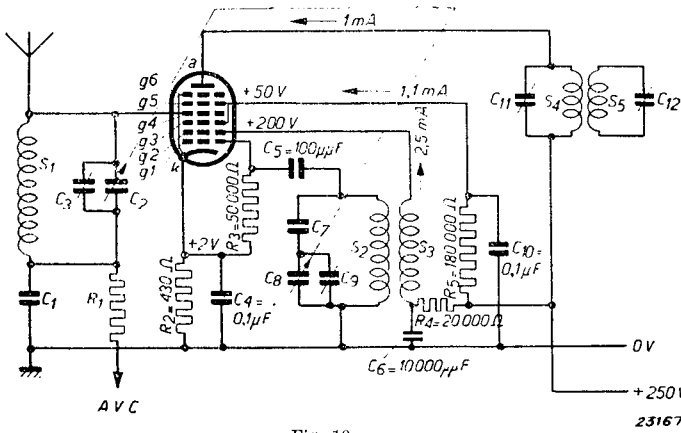

Fig. 10
Circuit diagram showing the application of the EK 2.

this will generally be of a high value, to provide adequate earthing of the circuit.

In the short-wave range it is not so simple to obtain a sufficiently high oscillator voltage, and the following values are recommended:

- $V_{g2} = 200 \text{ V}$
- $V_{g3,5} = 80 \text{ V}$

This generally provides an oscillator voltage of 5 to 6 V_{eff} , but if the

magnification of the circuits is very good this potential will be higher. It is not good practice to aim at producing extra high voltages for short-wave reception, as the tuned input circuit of the octode will then tend to oscillate; an oscillator voltage of 5 to 6 V_{eff} is quite good and the valve can best be made to operate on this value.

Frequency drift is especially troublesome in the short-wave range; whilst theoretically almost negligible in the broadcast bands, this factor must certainly be taken into account in short-wave operation. Drift due to mains voltage fluctuations is so slight as to make no difference on short-waves; at a wavelength of 13 metres it is only 5 kc/s. On the other hand, frequency drift in the 13—50 m band caused by variations in the bias on the

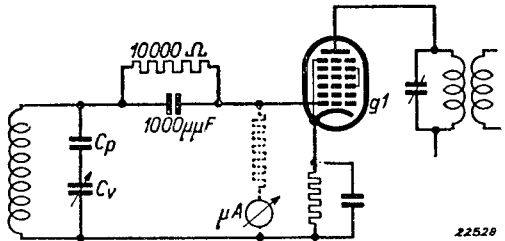

Fig. 11
Circuit employing a low value of grid leak (10,000 ohms). The method of measuring the amplitude of the oscillator voltage by means of the grid current is also shown.

fourth grid is so great that control must not be applied in that range. If, despite this fact, control is to be employed, it is essential to use a separate triode as oscillator, although it is much better to omit the control from the mixing valve and precede the octode by a variable-mu R.F. amplifier pentode, applying the control to that valve. Without this R.F. amplifier the sensitivity in the short-wave range is not very high and it is therefore sufficient to control the I.F. valve only.

Since suppression of the image-frequency in short-wave reception (due to the lower magnification of the R.F. circuits in that range) is more difficult than in the broadcast wave-bands, it is advisable in receivers for short-wave reception to employ a high intermediate frequency (450—475 kc/s), which is, moreover, advantageous in suppressing electronic coupling. At lower intermediate frequencies it

is good practice, in order to simplify balancing of the circuits, to detune the input stage by about 500 kc/s at the lower end of the wave-range, i.e., to increase the difference between the oscillator and input frequencies by 500 kc/s. This has practically no effect on the sensitivity, but it does facilitate the trimming. In the broadcast range the oscillator frequency should be higher than that of the input, or it will not be found possible to cover the whole of the range, but on short waves, in view of electronic coupling, the situation should be reversed.

The inclusion of a small compensating capacitor definitely reduces the inductive effect but does not entirely eliminate it, since too much compensation causes the input circuit to oscillate. In the 13—50 m band the padding capacitor is often omitted, the difference in frequency being obtained from differences in the self-inductance and trimming capacitor; the oscillator frequency can therefore be lower than the input frequency also in this range.

The tuned oscillator circuit must be coupled to the first grid and the reaction coil to the second (oscillator anode). The EK 2 may also be used successfully as a self-oscillating mixer valve in the 5—13 m wave-band, but this range cannot be fully covered without the use of switches. The oscillator can be maintained in oscillation only over a small part of this range, for instance from 6 to 8 metres, but for that matter it would be difficult to include the whole range of from 5 to 15 m on a single scale. Fig. 14 shows the construction of a coil suitable for use between 6 and 8 metres and, for the rest, extreme accuracy and simplicity of controls are essential features.

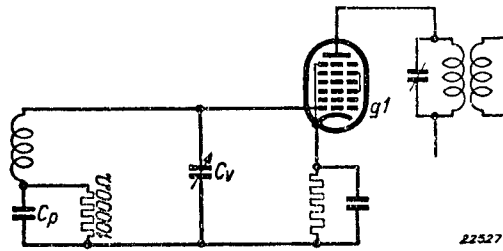

Fig. 12
Circuit for low value of grid leak, with padding capacitor in series with the coil.

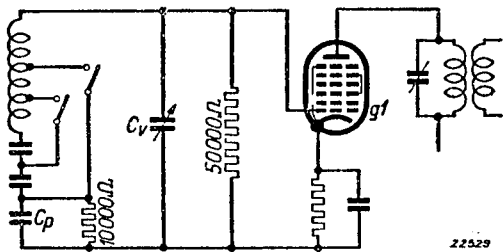

Fig. 13
Diagram of oscillator circuit with low-value grid leak, and low-value padding capacitor for medium and long-wave reception.

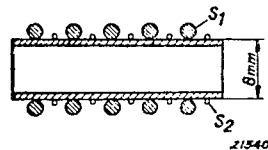

Fig. 14
Oscillator coil for use on very short waves (6 to 8 metres). S_1 = 5 turns of 2 mm bare copper wire (not tinned). S_2 = 5 turns of 0.1–0.2 mm enamelled copper wire.