



EK79001D

PRELIMINARY DATA SHEET

1536-Output TFT LCD
Source Driver with TCON

fitipower integrated technology Inc.

Table of Contents

	Page
1. GENERAL DESCRIPTION	3
2. FEATURES.....	3
3. BLOCK DIAGRAM.....	4
4. PIN DESCRIPTION	9
4.1. Value of wiring resistance to each pin.....	13
5. 3_WIRE SERIAL PORT INTERFACE.....	14
5.1. 3-Wire Command Format	14
6. FUNCTION DESCRIPTION	17
6.1. Power On/Off Sequence.....	17
6.2. Power-On/Off Timing Sequence.....	17
6.3. Input Data VS Output Channels.....	18
6.4. Input Data VS Output Voltage	19
6.5. Input Data and Output Voltage Reference Table.....	20
6.6. Data Input Format for LVDS	22
6.7. Data Input Format for TTL.....	23
6.8. Parallel RGB Timing Characteristic	24
7. ELECTRICAL SPECIFICATION	28
7.1. Absolute Maximum Ratings.....	28
7.2. Recommended Operating Range.....	28
7.3. DC Electrical Characteristics.....	29
7.4. AC Electrical Characteristics.....	32
7.5. Output Timing Table	35
8. SDRRS TIMING DIAGRAM	39
9. CHIP OUTLINE DIMENSIONS	40
9.1. Alignment Mark	41
9.2. Pad Coordinate	41
10. DEFINITIONS.....	51
10.1. Data Sheet Status	51
10.2. Life Support Application.....	51

Single Chip 1536 Channel Source Driver with Timing Controller for 1024RGB x 600 TFT LCD

1. GENERAL DESCRIPTION

The EK79001 is a highly integrated solution for small size to middle size a-Si TFT-LCD panels. This chip integrates 1536ch dual gate mode source driver with LVDS and parallel RGB input interface.

2. FEATURES

- Special design for 1024RGBx600 TFT LCD Panel with LVDS/TTL interface
- Integrate 1536 channel source driver with single or dual gate function
- Support cascade function with bidirectional shift control (CMOS signal)
- Support panel resolution (HxV) : 1024(RGB) x 768 , 1024(RGB) x 600 ,
800(RGB) x 600 , 800(RGB) x 480
- 8-bit resolution 256 gray-scale with Dithering (6 bits DAC + 2 bit FRC or HFRC)
- Support Pin Control function for Up/Down, Left/Right... control
- Power for digital circuit(VDD): 2.3V ~ 3.6V
- Power for analog circuit(AVDD): 8V ~ 13.5V
- Operating frequency : 71 MHz (Max.)
- Embedded Gamma Table for special custom request
- V1~V14 for adjusting Gamma correction
- 1 + 2 dot inversion architecture
- Built-In PWM controller for AVDD, Charge pump for VGH / VGL, and VCOM buffer
- Built-In CABC function
- Built-In AUTO pattern
- Built-In SDRRS function
- Support no. clock detection
- COG package
- Chip size = 25000um x 700um
- Output bump pitch = 15um

3. BLOCK DIAGRAM

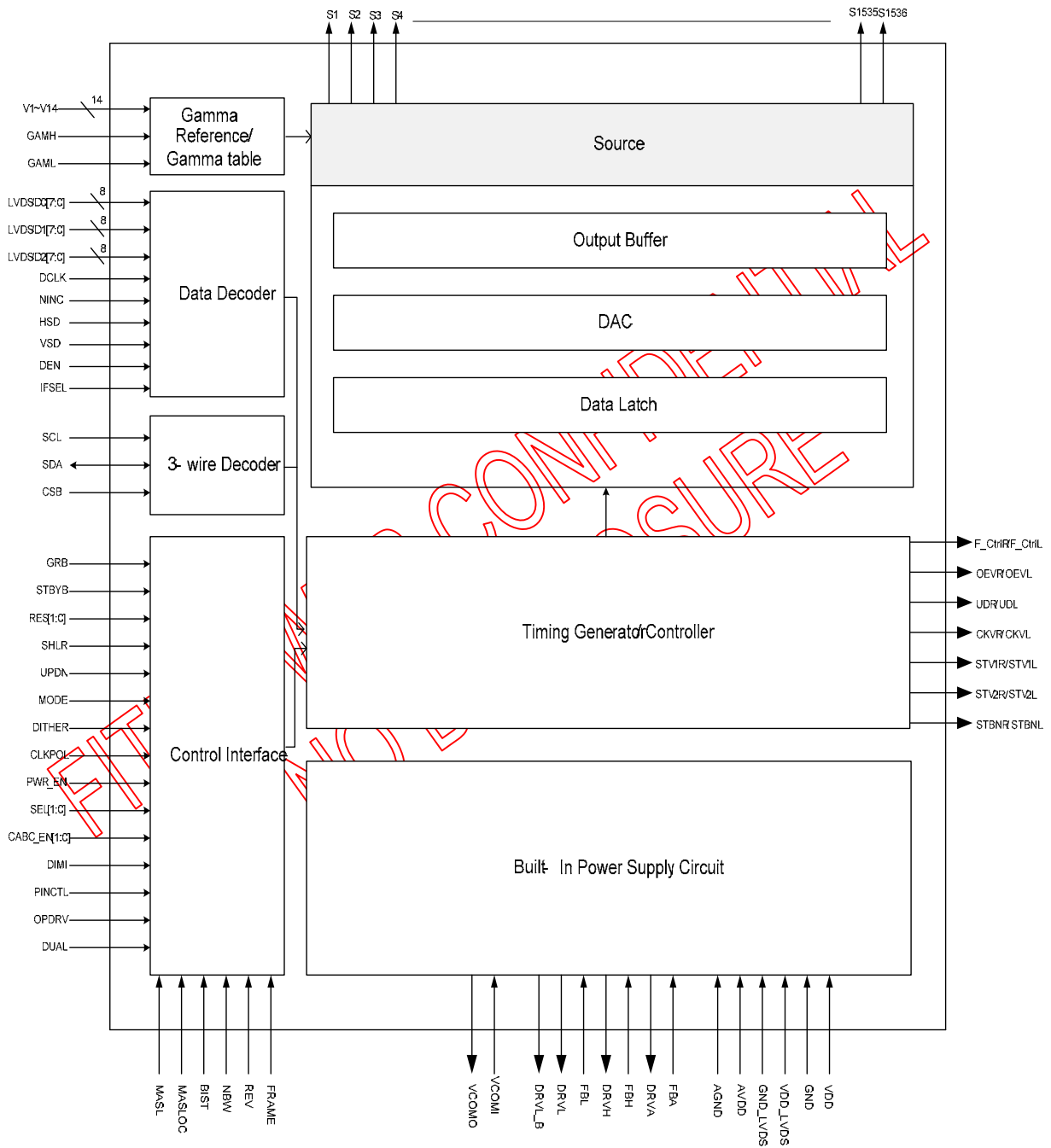

Block Diagram

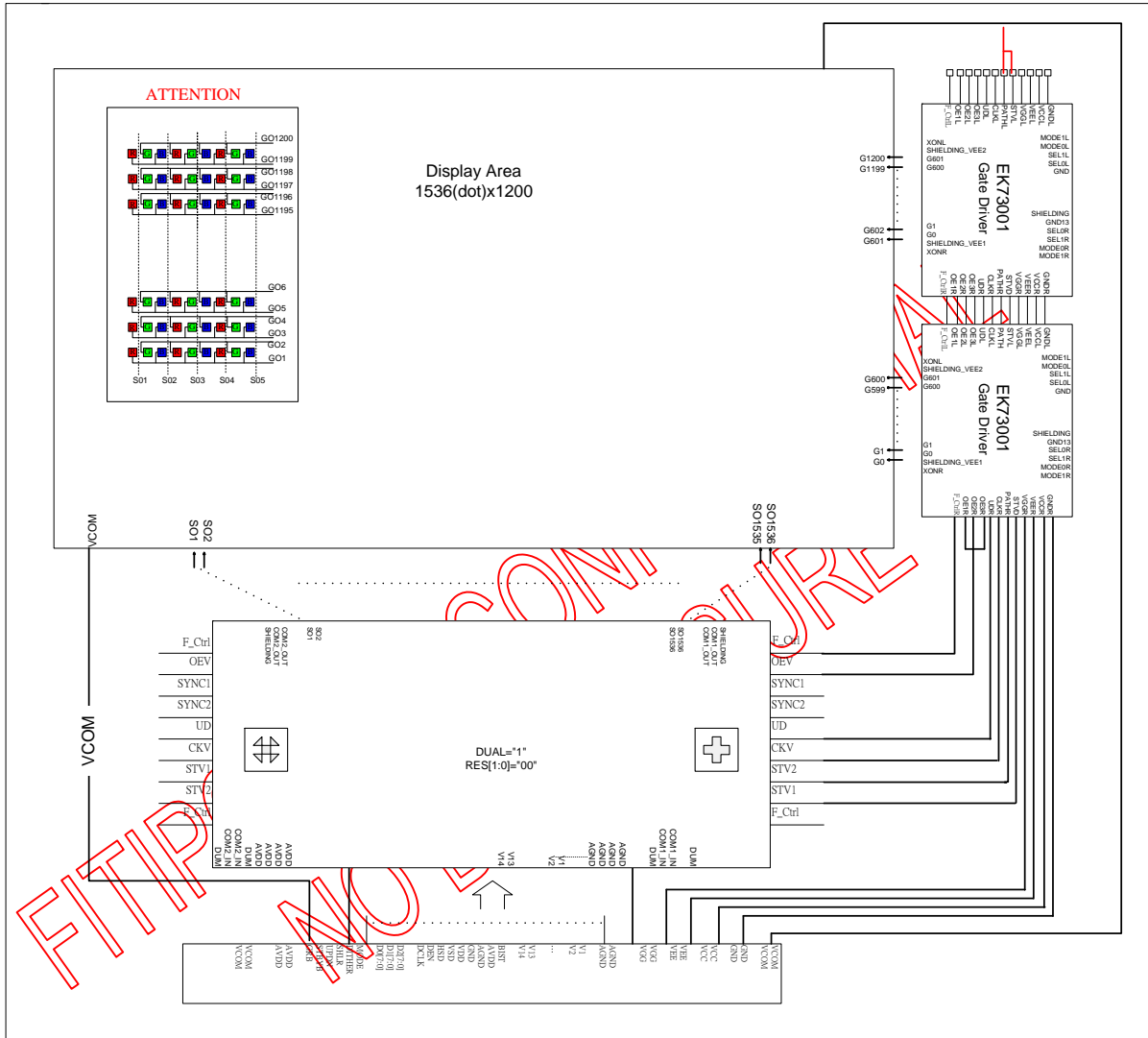

Application Block Diagram-Dual Gate Application

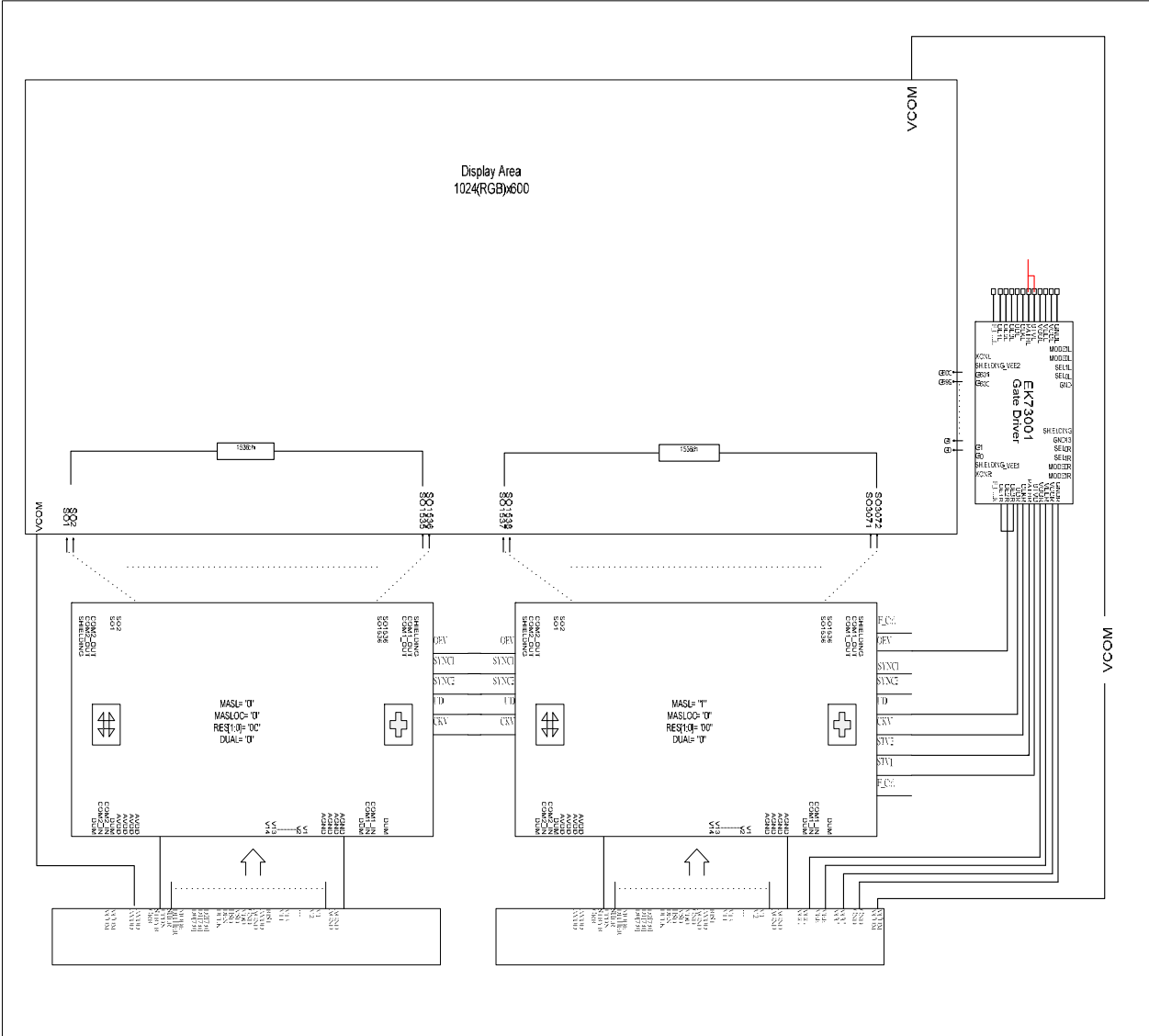

Application Block Diagram-Cascade Application

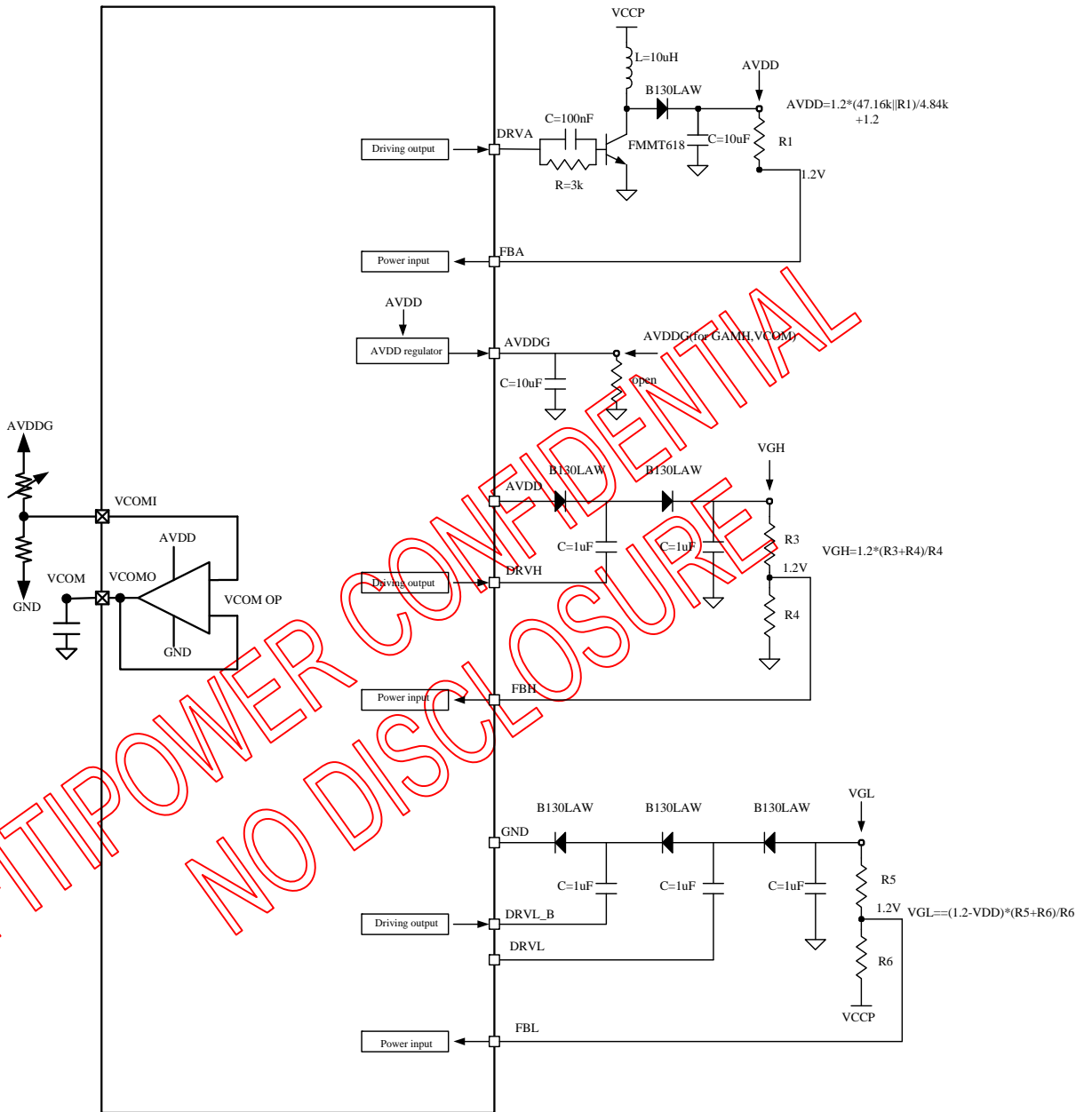

Application Power Circuit

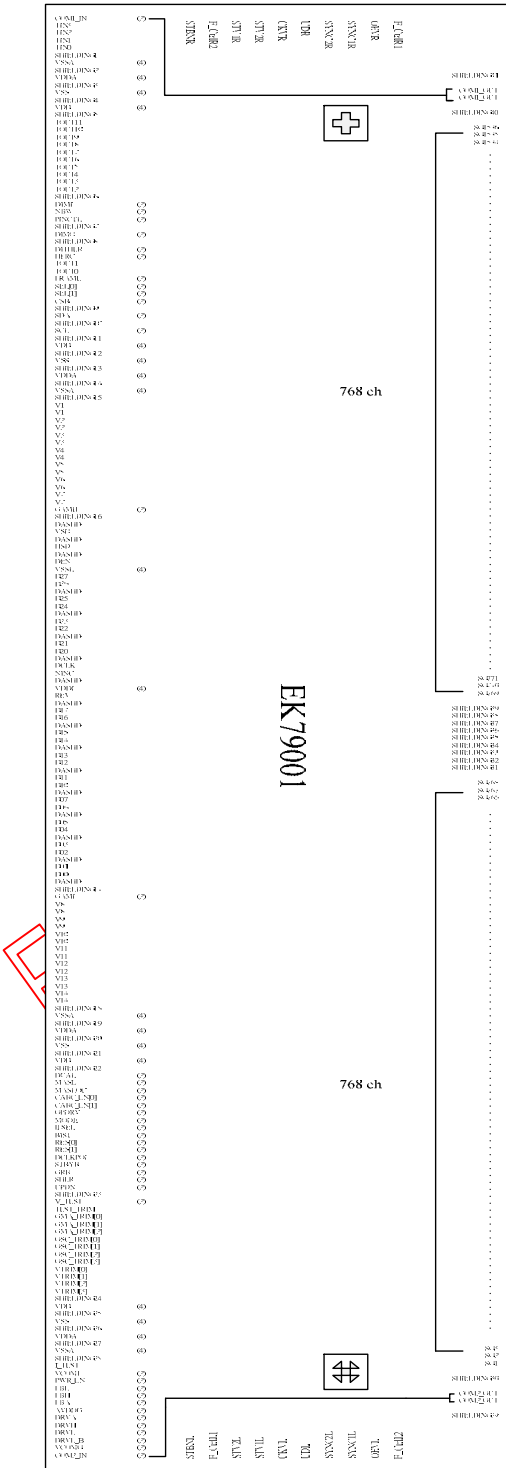

Pad Sequence(Bump Side)

4. PIN DESCRIPTION

Pin Description

Pin Name	Pin Type	Description															
D07~D00 D17~D10 D27~D20	Input	LVDS or Parallel RGB data Input. Select by "IFSEL" pin.															
		<table border="1"> <thead> <tr> <th>Pin name</th> <th>TTL input mode IFSEL="L"</th> <th>LVDS input mode IFSEL="H"</th> </tr> </thead> <tbody> <tr> <td>D2[0],D2[1]</td> <td>B[0],B[1]</td> <td>NIND0,PIND0</td> </tr> <tr> <td>D2[2],D2[3]</td> <td>B[2],B[3]</td> <td>NIND1,PIND1</td> </tr> <tr> <td>D2[4],D2[5]</td> <td>B[4],B[5]</td> <td>NIND2,PIND2</td> </tr> <tr> <td>D2[6],D2[7]</td> <td>B[6],B[7]</td> <td>NIND3,PIND3</td> </tr> </tbody> </table>	Pin name	TTL input mode IFSEL="L"	LVDS input mode IFSEL="H"	D2[0],D2[1]	B[0],B[1]	NIND0,PIND0	D2[2],D2[3]	B[2],B[3]	NIND1,PIND1	D2[4],D2[5]	B[4],B[5]	NIND2,PIND2	D2[6],D2[7]	B[6],B[7]	NIND3,PIND3
		Pin name	TTL input mode IFSEL="L"	LVDS input mode IFSEL="H"													
		D2[0],D2[1]	B[0],B[1]	NIND0,PIND0													
		D2[2],D2[3]	B[2],B[3]	NIND1,PIND1													
D2[4],D2[5]	B[4],B[5]	NIND2,PIND2															
D2[6],D2[7]	B[6],B[7]	NIND3,PIND3															
LVDS 6 bit data input : PIND[2:0], NIND[2:0]. For LVDS IF, please place termination resistor(100 ohm) for PIND0/NIND0,PIND1/NIND1,PIND2/NIND2,PIND3/NIND3.																	
D[07:00] = R[7:0] data; D[17:10] = G[7:0] data; D[27:20] = B[7:0] data. For 18bit RGB interface, connect two LSB bits of all the R/G/B data buses to GND.																	
Note : D07~D00 -> SO1 , SO4 ... SO1531 , SO1534 D17~D10 -> SO2 , SO5 ... SO1532 , SO1535 D27~D20 -> SO3 , SO6 ... SO1533 , SO1536 Please note the relation between RGB data and Color Filter sequence																	
DCLK	Input	Clock Input pin for LVDS or TTL mode. Select by "IFSEL" pin. For LVDS IF, please place termination resistor(100 ohm) for PINC/NINC.															
		<table border="1"> <thead> <tr> <th>Pin name</th> <th>TTL input mode IFSEL="L"</th> <th>LVDS input mode IFSEL="H"</th> </tr> </thead> <tbody> <tr> <td>DCLK</td> <td>DCLK</td> <td>PINC</td> </tr> </tbody> </table>	Pin name	TTL input mode IFSEL="L"	LVDS input mode IFSEL="H"	DCLK	DCLK	PINC									
Pin name	TTL input mode IFSEL="L"	LVDS input mode IFSEL="H"															
DCLK	DCLK	PINC															
NINC	Input	Negative LVDS differential clock input. For LVDS IF, please place termination resistor(100 ohm) for PINC/NINC.															
HSD	Input	Horizontal Sync input for TTL mode. Negative polarity. (In LVDS interface connected HSD to FPC for pin setting HSD="L":8 bit HSD="H":6 bit)															
VSD	Input	Vertical Sync input for TTL mode. Negative polarity. (In LVDS Interface , connected to FPC and pull low)															
DEN	Input	Data Input Enable. Active High to enable the data input bus under "DE Mode". Normally pull low.															
MODE	Input	DE / SYNC mode select under TTL mode. Normally pull high H : DE mode. L : HSD/VSD mode.															
IFSEL	Input	IFSEL = L : TTL interface IFSEL = H : LVDS interface															

Pin Name	Pin Type	Description
RES[1:0]	Input	RES[1:0]="01", for 1024(RGB)*768 display resolution(dual or cascade) RES[1:0]="00", for 1024(RGB)*600 display resolution(dual or cascade (Default) RES[1:0]="10", for 800(RGB)*600 display resolution(dual or cascade) (601~936 channel disable) RES[1:0]="11", for 800(RGB)*480 display resolution(dual or cascade) (601~936 channel disable)
DITHER	Input	Dithering function enable control. Normally pull low In LVDS 6-bit mode, IC don't care DITHER and HFRC setting. DITHER = "1", Enable internal dithering function DITHER = "0", Disable internal dithering function. If in LVDS 8-bit or TTL mode, IC will bypass D01/D00, D11/D10, D21/D20.
HFRC	Input	H-FRC selection. Normally pull low HFRC = H : H-FRC enable If "DITHER" = "L", disable dithering function(HFRC and FRC disable)
DCLKPOL	Input	Input clock edge selection. Normally pull low CLKPOL = "1", Latch data at DCLK rising edge. CLKPOL = "0", Latch data at DCLK falling edge. (Default)
DUAL	Input	Dual Gate function enables control. Normally pull high DUAL = "1", Enable Dual Gate Function. (Default) DUAL = "0", Disable Dual Gate Function Note: Cascade function will be disabled under "dual gate" mode!!
V1~V14	Input	When INTERNAL Gamma Table is used. GAMH tied to AVDDG , GAML tied to GND and V1~V14 pad are un-used. When using external gamma voltage, GAMH and GAML are floating , and V1~V14 are the external gamma correction points. The voltage of these pins must be: AGND<V14<V13<V12<V11<V10<V9<V8;V7<V6<V5<V4<V3<V2<V1<AVDD .
GAMH	Input	When using INTERNAL Gamma Table , tied to AVDDG . Otherwise floating.
GAML	Input	When using INTERNAL Gamma Table , tied to GND . Otherwise floating.
GRB	Input	Global reset pin. Active Low to enter Reset State. Normally pull high. Must to connecting with an RC reset circuit for stability. (GRB delay VDD larger than 1ms)
STBYB	Input	Standby mode, Normally pulled high. STBYB = "1", normal operation STBYB = "0", timing controller, source driver will turn off, all output are High-Z
MASL	Input	Master and Slave Mode selection. Normally pull high. MASL = "H", for Master mode. (Default Mode) MASL = "L", for Slave mode. Only the Master chip will issue the Gate and Cascade control signal.
MASLOC	Input	Master location definition pin. Normally pull low. MASLOC = "L", Master locate on right side (Panel top view). (Default Mode) MASLOC = "H", Master locate on left side (Panel top view).

Pin Name	Pin Type	Description															
SHLR	Input	Source Right or Left sequence control. Normally pull high. SHLR = "L", shift left: last data = S1←S2←S3.....←S1536 = first data. SHLR = 'H' , shift right: first data = S1→S2→S3.....→S1536 = last data.															
UPDN	Input	Gate Up or Down scan control. Normally pull low. UPDN = "L", STV2 output vertical start pulse and UD pin output logical "0" to Gate driver. UPDN = "H", STV1 output vertical start pulse and UD pin output logical "1" to Gate driver.															
BIST	Input	Normal Operation/BIST pattern select. Normally pull low BIST = H : BIST(DCLK input is not needed) BIST = L : Normal Operation															
NBW	Input	Normally black or normally white setting. Normally pulled low. NBW = H : Normally black NBW = L : Normally white															
REV	Input	Controls whether the data of D00~D27 are inverted or not, normally pulled low. When "REV"=1 these data will be inverted. EX. "00"→"3F", "07"→"38", "15"→"2A", and so on.															
FRAME	Input	Frame inverse or not select. Normally pull low. FRAME = "1", Uniform FRAME = "0", Frame inverse (Default)															
SEL[1:0]	Input	Gate on sequence select. Normally pull low															
		<table border="1"> <thead> <tr> <th>SEL[0]</th> <th>SEL[1]</th> <th>Pin control function</th> </tr> </thead> <tbody> <tr> <td>1</td> <td>1</td> <td>Z+\bar{z}</td> </tr> <tr> <td>1</td> <td>0</td> <td>\bar{z}</td> </tr> <tr> <td>0</td> <td>1</td> <td>z</td> </tr> <tr> <td>0</td> <td>0</td> <td>Z(default)</td> </tr> </tbody> </table>	SEL[0]	SEL[1]	Pin control function	1	1	Z+ \bar{z}	1	0	\bar{z}	0	1	z	0	0	Z(default)
		SEL[0]	SEL[1]	Pin control function													
		1	1	Z+ \bar{z}													
		1	0	\bar{z}													
0	1	z															
0	0	Z(default)															
OEVR/OEVL	Output	Gate driver control signal (CABC and BIST sync control)															
SYNC1R/SYNC1L	Output	CABC and BIST sync control															
SYNC2R/SYNC2L	Output	CABC and BIST sync control															
UDR/UDL	Output	Gate driver control signal (CABC and BIST sync control)															
CKVR/CKVL	Output	Gate driver control signal (CABC and BIST sync control)															
STV1R/STV1L	Output	Gate driver control signal															
STV2R/STV2L	Output	Gate driver control signal															
STBNR/STBNL	Output	Gate driver control signal															
F_CtrlR/F_CtrlL	Output	Gate driver control signal (For special Gate on sequence). NOTE : In Cascade structure, let this pin floating. In Dual Gate structure , connect this pin to gate driver's F_Ctrl . And setting gate driver's SEL[1:0] to "00".															
CABC_EN[1:0]	Input	CABC H/W enable pin. Normally pull low. When CABC_EN="00", CABC OFF. (Default mode) When CABC_EN="01", User interface Image. When CABC_EN="10", Still Picture. When CABC_EN="11", Moving Image.															
DIMI	Input	Brightness control signal. Normally pull high.															

Pin Name	Pin Type	Description
DIMO	Output	Backlight dimmer signal for external controller. DIMO = "0", Turn off external backlight controller DIMO = "1", Logical control signal to turn on external backlight controller NOTE : If CABC OFF , DIMO = DIMI . Else DIMO is controlled by CABC
PINCTL	Input	Enable pin control function. Normally pull high PINCTL="0", Disable pin control function. The following pin will be inactive: MODE,RES[1:0],DITHER,HFRC,DCLKPOL,SHLR,UPDN,BIST,NBW,FRAME,SEL[1:0],CABC_EN[1:0],OPDRV,PWR_EN. PINCTL="1", Enable pin control function. NOTE: The related 3-wire control register bit control will be disabled under PINCTL="1".
OPDRV	Input	Source OP driving selection. Normally pull low OPDRV = H : 133% OPDRV = L : normal
CSB	Input	Serial communication chip select. Normally pull low
SDA	Input/Output	Serial communication data input. Normally pull low
SCL	Input	Serial communication clock input. Normally pull low
AVDD	PI	Power supply for analog circuits
AGND	PI	Ground pins for analog circuits
VDD	PI	Power supply for digital circuits
GND	PI	Ground pins for digital circuits
VDD_LVDS	PI	LVDS power
GND_LVDS	PI	LVDS ground
PWR_EN	Input	POWER enable. Normally pull low PWR_EN = H , enable PWM , Charge pump and VCOM buffer PWR_EN = L , disable PWM , Charge pump and VCOM buffer
FBA	VI	PWM controller feedback input. (for AVDD)
DRVA	Output	PWM output driver signal for the boost converter (for AVDD)
FBH	VI	Charge Pump controller feedback input. (for VGH)
DRVH	Output	Charge Pump driver signal for the boost converter (for VGH)
FBL	VI	Charge Pump controller feedback input. (for VGL)
DRVL	Output	Charge Pump driver signal for the boost converter (for VGL)
DRVL_B	Output	Inverse of DRVL(for VGL)
VCOMI	Input	VCOM buffer in
VCOMO	Output	VCOM buffer out
AVDDG	Output	AVDD regulator output
SO1~SO1536	Output	Source Driver Output Signals All outputs will be of unknown values under stand-by mode.
COM1_IN COM1_OUT	S	Internal link together between input side and output side
COM2_IN COM2_OUT	S	Internal link together between input side and output side.
TP	T	Float these pins for normal operation
SHIELDING	SH	Those pins are internally connected to the AGND. DO NOT connect to any WOA on the panel. Data Bus Shielding pad
DASHD	SH	Those pins are internally connected to the GND. RECOMMAND to add shielding lines on the FPC to reduce EMI.

Pin Name	Pin Type	Description
DUM	Dummy	Dummy pads. Those pins are floating pads.

Note:

P: Power, D: Dummy, S: Shorted line, M: Mark, PI: Power input, PO: Power output,
T: Testing, SH: Shielding, PS: Power Setting, C: Capacitor pin.

EK79001 Pass Line Description:

Pass Line No:	Pad Name	
1	COM1_IN	COM1_OUT
2	COM2_IN	COM2_OUT

4.1. Value of wiring resistance to each pin

The recommended wiring resistance values are shown below. The wiring resistance values affect the current capacity of the power supply, so be sure to design using values that do not exceed those recommended.

wiring resistance

Pin Name	Wiring Resistance value(Ω)	Pin Name	Wiring resistance value (Ω)
AVDD	<5	RES0	<100
AGND	<5	RES1	<100
VDD	<5	SHLR	<100
GND	<5	UPDN	<100
V1~V14	<5	BIST	<100
DRVx	<5	MODE	<100
FBx	<5	DCLKPOL	<100
VCOMI	<5	DIMO	<100
VCOMO	<5	IFSEL	<100
D00~D07	<5	F_Ctrlx	<500
D10~D17	<5	OEVx	<500
D20~D27	<5	UDx	<500
DCLK	<5	CKVx	<500
NINC	<5	STV1x	<500
VSD	<20	STV2x	<500
HSD	<20	STBNx	<500
DEN	<20		
GRB	<100		
STBYB	<100		
DITHER	<100		

5. 3_WIRE SERIAL PORT INTERFACE

5.1. 3-Wire Command Format

EK79001 use the 3-wire serial port as communication interface for all the function and parameter setting.

3-Wire communication can be bi-directional controlled by the “R/W” bit in address field. EK79001 3-Wire engine act as a “slave mode” for all the time, and will not issue any command to the 3-Wire bus itself.

Under read mode, 3-Wire engine will return the data during “Data phase”. The returned data should be latched at the rising edge of SCL by external controller. Data in the “Hi-Z phase” will be ignored by 3-Wire engine during write operation, and should be ignored during read operation also. During read operation, external controller should float SDA pin under “Hi-Z phase” and “Data phase”.

Each Read/Write operation should be exactly 16 bit. To prevent from incorrect setting of the internal register, any write operation with more or less than 16 bit data during a CSB Low period will be ignored by 3-Wire engine.

For prevent from incorrect setting of the internal register, Please refer to the section of “3-Wire Timing.

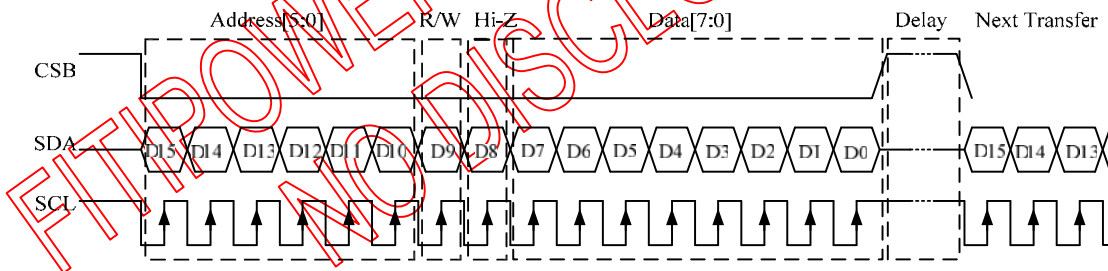

3-Wire timing chart

3-Wire Command Format

Bit	Description
D15~D10	Register Address [5:0].
D9	W/R control bit. “0” for Write; “1” for Read
D8	Hi-Z bit during read mode. Any data within this bits will be ignored during write mode
D7~D0	Data for the W/R operation to the address indicated by Address phase

3-Wire Write Format

MSB															LSB
D15	D14	D13	D12	D11	D10	D9	D8	D7	D6	D5	D4	D3	D2	D1	D0
Register Address[5:0]						0	X	Data(Issue by external controller)							

3-Wire Read Format

MSB															LSB
D15	D14	D13	D12	D11	D10	D9	D8	D7	D6	D5	D4	D3	D2	D1	D0

Register Address[5:0]	1	Hi-Z	Data(Issue by 3-wire engine)
-----------------------	---	------	------------------------------

3-Wire Control Registers:

Following table list all the 3-Wire control registers and bit name definition for EK79001. Refer to the next section for detail register function description please.

Setting of all the 3-Wire registers will take effect at the coming falling edge of VSD except GRB and STB bit.

R0: System Control Register:

Designation	Address	Description
Mode	R0[0]	DE/SYNC mode select. MODE="0", HSD/VSD mode MODE="1", DE mode(default)
DCLKPOL	R0[1]	DCLK polarity control bit. DCLKPOL="0": Data sampling at DCLK falling edge. (Default) DCLKPOL="1": Data sampling at DCLK rising edge.
GRB	R0[2]	Global reset bit. GRB="0", The controller is in reset State. GRB="1", Normal operation. (Default)
STBYB	R0[3]	Standby mode selection bit. STBYB="0", Timing control, driver and DC-DC converter, are off, and all outputs are High-Z. STBYB="1", Normal operation. (Default)
UPDN	R0[4]	Gate Up or Down scan control. UPDN = "0", STV2 output vertical start pulse and UD pin output logical "0" to Gate driver. (Default) UPDN = "1", STV1 output vertical start pulse and UD pin output logical "1" to Gate driver.
SHLR	R0[5]	Right/Left sequence control of source driver. SHLR="0", Shift left: Last data = S1<S2<S3<...<S960=First data SHLR="1", Shift right: First data = S1<S2<S3<...<S960=Last data(Default)
	R0[6]	Reserved
PWM_EN	R0[7]	POWER enable. PWR_EN = H , enable PWM , Charge pump and VCOM buffer PWR_EN = L , disable PWM , Charge pump and VCOM buffer (Default)

R1: System Control Register:

Designation	Address	Description
		Reserved
RES[1:0]	R1[2:1]	RES[1:0] = "01", for 1024(RGB)*768 display resolution(dual or cascade) RES[1:0] = "00", for 1024(RGB)*600 display resolution(dual or cascade) (default) RES[1:0] = "10", for 800(RGB)*600 display resolution(dual or cascade) (601~936 channel disable) RES[1:0] = "11", for 800(RGB)*480 display resolution(dual or cascade) (601~936 channel disable)
BIST	R1[3]	Normal Operation/BIST pattern select. BIST = H : BIST(DCLK input is not needed) BIST = L : Normal Operation (Default)
DITHER	R1[4]	Dithering function enable control. DITHER = "1", Enable internal dithering function DITHER = "0", Disable internal dithering function (Default)
HFRC	R1[5]	H-FRC selection. HFRC = H : H-FRC enable

		HFRC = L : FRC enable (Default) If DITHER="0", disable dithering function(H-FRC and FRC disable)
CABC_EN[1:0]	R1[7:6]	CABC H/W enable pin. Normally pull low. When CABC_EN="00", CABC OFF. (Default mode) When CABC_EN="01", User interface Image. When CABC_EN="10", Still Picture. When CABC_EN="11", Moving Image

R2: System Control Register:

Designation	Address	Description
		Reserved
NBW	R2[6]	Normally black or normally white setting. NBW="H": Normally black. NBW="L": Normally white(Default).
	R2[7]	Reserved

R3: Gate on sequence Controller Register:

Designation	Address	Description															
SEL[1:0]	R3[1:0]	Gate on sequence select.															
		<table border="1"> <thead> <tr> <th>SEL[0]</th> <th>SEL[1]</th> <th>Pin control function</th> </tr> </thead> <tbody> <tr> <td>1</td> <td>1</td> <td>Z+E</td> </tr> <tr> <td>1</td> <td>0</td> <td>E</td> </tr> <tr> <td>0</td> <td>1</td> <td>S</td> </tr> <tr> <td>0</td> <td>0</td> <td>Z(default)</td> </tr> </tbody> </table>	SEL[0]	SEL[1]	Pin control function	1	1	Z+E	1	0	E	0	1	S	0	0	Z(default)
		SEL[0]	SEL[1]	Pin control function													
		1	1	Z+E													
		1	0	E													
0	1	S															
0	0	Z(default)															
FRAME	R3[2]	Frame inverse or not select. FRAME = "1", Uniform FRAME = "0", Frame inverse(Default)															
		Reserved															

6. FUNCTION DESCRIPTION

6.1. Power On/Off Sequence

In order to prevent IC from power on reset fail, the rising time (TPOR) of the digital power supply VDD should be maintained within the given specifications. Refer to “AC Characteristics” for more detail on timing.

6.2. Power-On/Off Timing Sequence

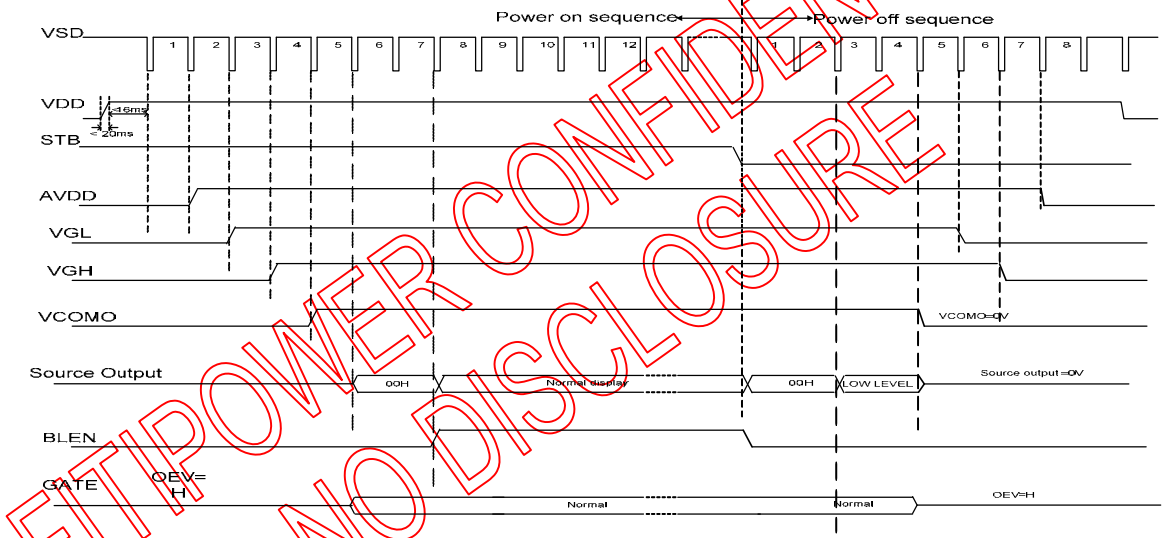

Power On/Off timing chart

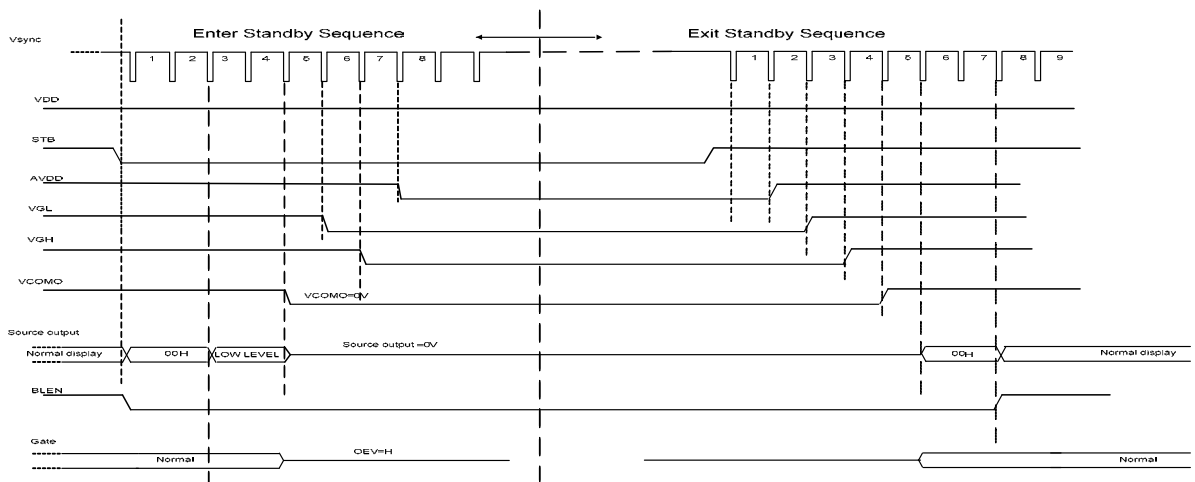

Enter and Exit Standby Mode timing chart

Note: Low level=3Fh, when NBW=L(Normally white)

Low level=00h,when NBW=H(Normally black)

6.3. Input Data VS Output Channels

6.3.1. DUAL="0"

SHLR="1",right shift

Output	SO1	SO2	SO3	-	SO1534	SO1535	SO1536
Order	First data			→	Last data		
Odd Line	D07~D00	D17~D10	D27~D20	---	D07~D00	D17~D10	D27~D20
Even Line	D07~D00	D17~D10	D27~D20	---	D07~D00	D17~D10	D27~D20

SHLR="0",left shift

Output	SO1	SO2	SO3	---	SO1534	SO1535	SO1536
Order	Last data			←	First data		
Odd Line	D07~D00	D17~D10	D27~D20	---	D07~D00	D17~D10	D27~D20
Even Line	D07~D00	D17~D10	D27~D20	---	D07~D00	D17~D10	D27~D20

6.3.2. DUAL="1"

SHLR="1",right shift

Output	SO1	SO2	SO3	---	SO1534	SO1535	SO1536
Order	First data			->	Last data		
Odd Line/ Gn	D07~D00	D27~D20	D17~D10	---	D07~D00	D27~D20	D17~D10
Odd Line/ Gn+1	D17~D10	D07~D00	D27~D20	---	D17~D10	D07~D00	D27~D20
Even Line/ Gn	D07~D00	D27~D20	D17~D10	---	D07~D00	D27~D20	D17~D10
Even Line/ Gn+1	D17~D10	D07~D00	D27~D20	---	D17~D10	D07~D00	D27~D20

SHLR="0",left shift

Output	SO1	SO2	SO3	---	SO1534	SO1535	SO1536
Order	Last data			<-	First data		
Odd Line/ Gn	D07~D00	D27~D20	D17~D10	---	D07~D00	D27~D20	D17~D10
Odd Line/ Gn+1	D17~D10	D07~D00	D27~D20	---	D17~D10	D07~D00	D27~D20
Even Line/ Gn	D07~D00	D27~D20	D17~D10	---	D07~D00	D27~D20	D17~D10
Even Line/ Gn+1	D17~D10	D07~D00	D27~D20	---	D17~D10	D07~D00	D27~D20

6.4. Input Data VS Output Voltage

The figure below shows the relationship between the input data and the output voltage. Refer to the following pages for the relative resistor values and voltage calculation method.

Gamma Tables vary for each customer.

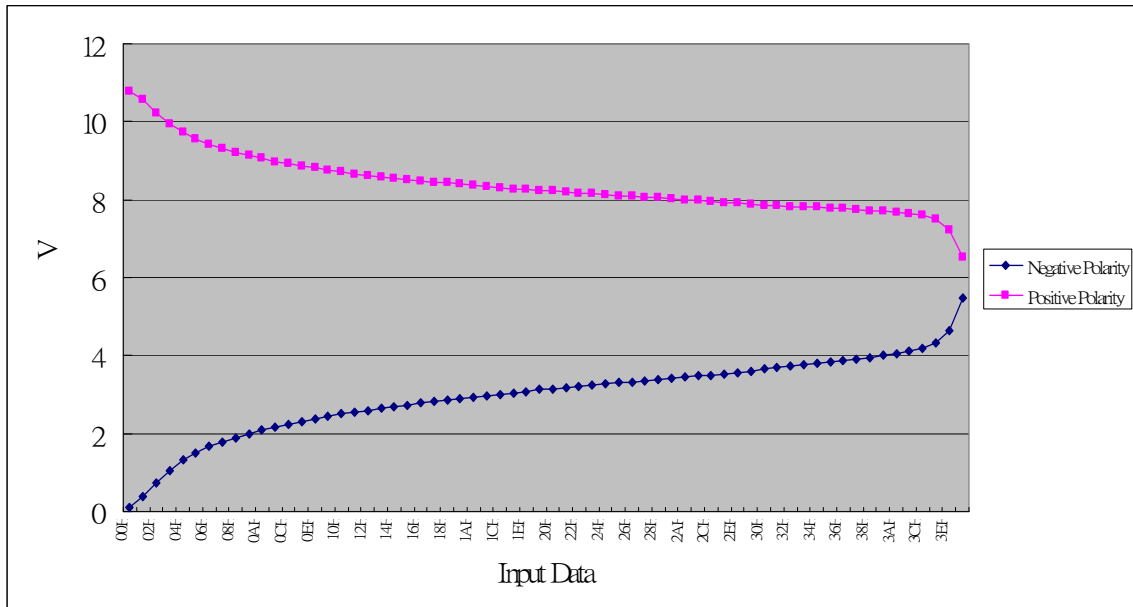

Remark: AVDD-0.1 > V1 > V2 > V3 > V4 > V5 > V6 > V7; V8 > V9 > V10 > V11 > V12 > V13 > V14 > AGND+0.1V

FITIPOWER NO DIB

6.5. Input Data and Output Voltage Reference Table

Input Data and Output Voltage Reference Table

@AVDD=11V

V1	V2	V3	V4	V5	V6	V7	V8	V9	V10	V11	V12	V13	V14	Unit
10.78	10.569	8.708	8.213	7.866	7.243	6.51	5.49	4.63	3.653	3.146	2.493	0.373	0.11	V

Data	Positive
00H	AVDDx0.980
01H	AVDDx0.961
02H	AVDDx0.930
03H	AVDDx0.905
04H	AVDDx0.885
05H	AVDDx0.870
06H	AVDDx0.857
07H	AVDDx0.847
08H	AVDDx0.838
09H	AVDDx0.830
0AH	AVDDx0.823
0BH	AVDDx0.816
0CH	AVDDx0.811
0DH	AVDDx0.806
0EH	AVDDx0.801
0FH	AVDDx0.796
10H	AVDDx0.792
11H	AVDDx0.788
12H	AVDDx0.784
13H	AVDDx0.781
14H	AVDDx0.778
15H	AVDDx0.775
16H	AVDDx0.772
17H	AVDDx0.769
18H	AVDDx0.766
19H	AVDDx0.763
1AH	AVDDx0.761
1BH	AVDDx0.758
1CH	AVDDx0.756
1DH	AVDDx0.753
1EH	AVDDx0.751
1FH	AVDDx0.748

Data	Positive
20H	AVDDx0.747
21H	AVDDx0.745
22H	AVDDx0.743
23H	AVDDx0.741
24H	AVDDx0.739
25H	AVDDx0.737
26H	AVDDx0.735
27H	AVDDx0.732
28H	AVDDx0.731
29H	AVDDx0.729
2AH	AVDDx0.727
2BH	AVDDx0.725
2CH	AVDDx0.723
2DH	AVDDx0.721
2EH	AVDDx0.719
2FH	AVDDx0.717
30H	AVDDx0.715
31H	AVDDx0.713
32H	AVDDx0.711
33H	AVDDx0.710
34H	AVDDx0.709
35H	AVDDx0.707
36H	AVDDx0.706
37H	AVDDx0.704
38H	AVDDx0.702
39H	AVDDx0.700
3AH	AVDDx0.697
3BH	AVDDx0.694
3CH	AVDDx0.690
3DH	AVDDx0.681
3EH	AVDDx0.658
3FH	AVDDx0.592

Data	Negative
00H	AVDDx0.010
01H	AVDDx0.034
02H	AVDDx0.068
03H	AVDDx0.096
04H	AVDDx0.119
05H	AVDDx0.136
06H	AVDDx0.151
07H	AVDDx0.162
08H	AVDDx0.172
09H	AVDDx0.182
0AH	AVDDx0.189
0BH	AVDDx0.197
0CH	AVDDx0.204
0DH	AVDDx0.210
0EH	AVDDx0.215
0FH	AVDDx0.221
10H	AVDDx0.227
11H	AVDDx0.231
12H	AVDDx0.236
13H	AVDDx0.240
14H	AVDDx0.245
15H	AVDDx0.248
16H	AVDDx0.253
17H	AVDDx0.256
18H	AVDDx0.260
19H	AVDDx0.263
1AH	AVDDx0.266
1BH	AVDDx0.270
1CH	AVDDx0.273
1DH	AVDDx0.277
1EH	AVDDx0.280
1FH	AVDDx0.284

Data	Negative
20H	AVDDx0.286
21H	AVDDx0.289
22H	AVDDx0.292
23H	AVDDx0.294
24H	AVDDx0.297
25H	AVDDx0.300
26H	AVDDx0.302
27H	AVDDx0.305
28H	AVDDx0.308
29H	AVDDx0.311
2AH	AVDDx0.314
2BH	AVDDx0.316
2CH	AVDDx0.318
2DH	AVDDx0.321
2EH	AVDDx0.325
2FH	AVDDx0.328
30H	AVDDx0.332
31H	AVDDx0.336
32H	AVDDx0.339
33H	AVDDx0.342
34H	AVDDx0.345
35H	AVDDx0.348
36H	AVDDx0.351
37H	AVDDx0.355
38H	AVDDx0.359
39H	AVDDx0.364
3AH	AVDDx0.369
3BH	AVDDx0.375
3CH	AVDDx0.382
3DH	AVDDx0.394
3EH	AVDDx0.421
3FH	AVDDx0.499

FITIPOWER CONFIDENTIAL
NO DISCLOSURE

6.6. Data Input Format for LVDS

6.6.1. 6-bit LVDS input(HSD="H")

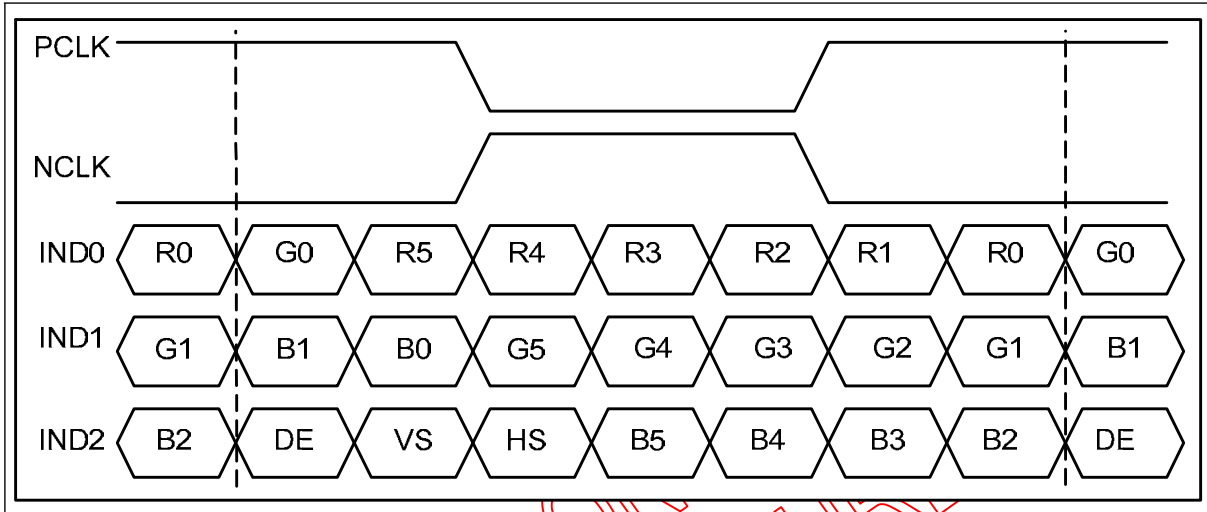

6-bit LVDS Input Timing chart

6.6.2. 8-bit LVDS input(HSD="L")

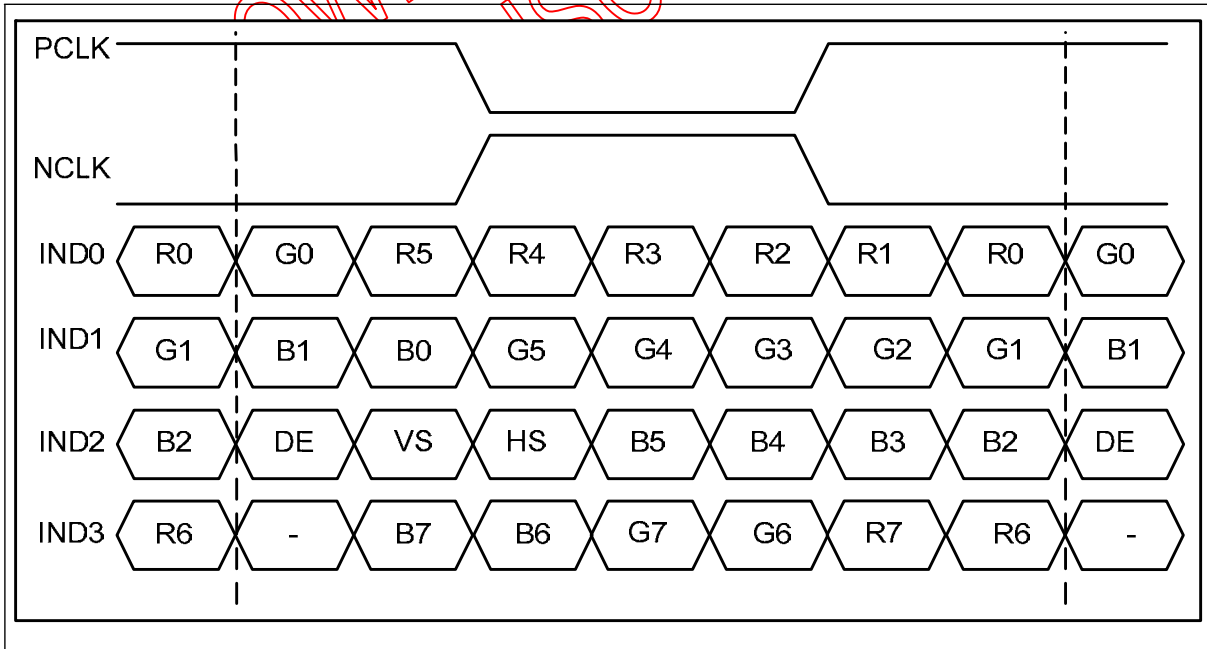

8-bit LVDS Input Timing chart

6.7. Data Input Format for TTL

6.7.1. Vertical input timing

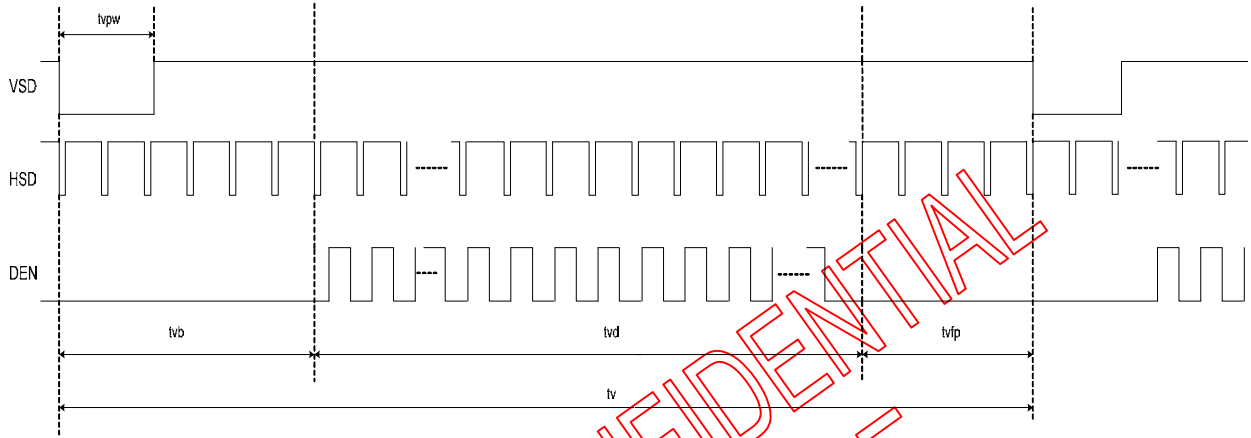

Vertical input timing

6.7.2. Horizontal input timing

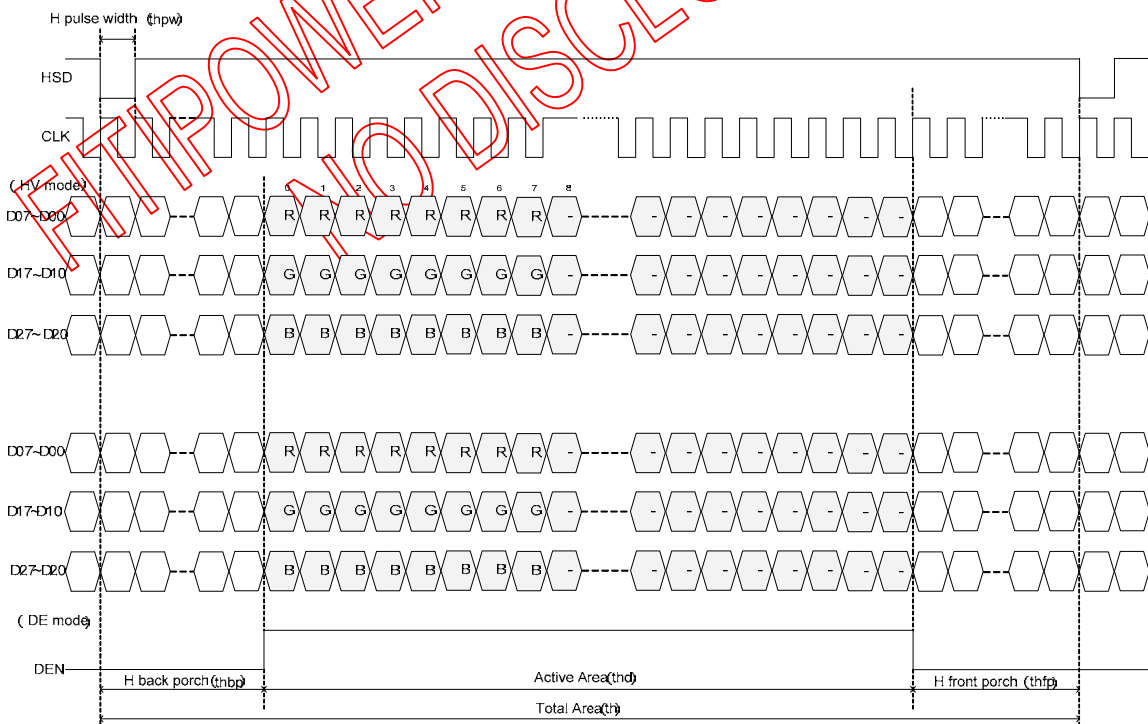

Horizontal input timing

6.8. Parallel RGB Timing Characteristic

6.8.1. For 1024RGB x 768 panel

DE mode

DE mode					
Parameter	Symbol	Value			Unit
		Min.	Typ.	Max.	
DCLK frequency @Frame rate=60hz	fclk	52	65	71	Mhz
Horizontal display area	thd	1024			DCLK
HSYNC period time	th	1114	1344	1400	DCLK
HSYNC blanking	thbp+thfp	90	320	376	DCLK
Vertical display area	tvd	768			H
VSYNC period time	tv	778	806	845	H
VSYNC blanking	tvb+tvfp	10	38	77	H

HV mode(1)

HV mode					
Horizontal input timing					
Parameter	Symbol	Value			Unit
Horizontal display area	thd	1024			DCLK
DCLK frequency@ Frame rate=60hz	fclk	Min.	Typ.	Max.	Mhz
		57	65	70.5	
1 Horizontal Line	th	1200	1344	1400	DCLK
HSYNC pulse width	thpw	Min.	1		
		Typ.	-		
		Max.	140		
HSYNC back porch	thbp	160	160	160	
HSYNC front porch	thfp	16	160	216	

HV mode(2)

Vertical input timing					
Parameter	Symbol	Value			Unit
		Min.	Typ.	Max.	
Vertical display area	tvd	768			H
VSYNC period time	tv	792	806	840	H
VSYNC pulse width	tvpw	1	-	20	H
VSYNC back porch	tvb	23	23	23	H
VSYNC front porch	tvfp	1	15	49	H

6.8.2. For 1024RGB x 600 panel

DE mode

DE mode					
Parameter	Symbol	Value			Unit
		Min.	Typ.	Max.	
DCLK frequency @Frame rate=60hz	fclk	40.8	51.2	67.2	Mhz
Horizontal display area	thd	1024			DCLK
HSYNC period time	th	1114	1344	1400	DCLK
HSYNC blanking	thb+thfp	90	320	376	DCLK
Vertical display area	tvd	600			H
VSYNC period time	tv	610	635	800	H
VSYNC blanking	tvb+tvfp	10	35	200	H

HV mode(1)

HV mode					
Horizontal input timing					
Parameter	Symbol	Value			Unit
		Min.	Typ.	Max.	
Horizontal display area	thd	1024			DCLK
DCLK frequency@ Frame rate=60hz	fclk	44.9	51.2	63	Mhz
1 Horizontal Line	th	1200	1344	1400	DCLK
HSYNC pulse width	thpw	Min.	1		
		Typ.	-		
		Max.	140		
HSYNC back porch	thbp	160	160	160	
HSYNC front porch	thfp	16	160	216	

HV mode(2)

Vertical input timing					
Parameter	Symbol	Value			Unit
		Min.	Typ.	Max.	
Vertical display area	tvd	600			H
VSYNC period time	tv	624	635	750	H
VSYNC pulse width	tvpw	1	-	20	H
VSYNC back porch	tvb	23	23	23	H
VSYNC front porch	tvfp	1	12	127	H

6.8.3. For 800RGB x 600 panel

DE mode

DE mode					
Parameter	Symbol	Value			Unit
		Min.	Typ.	Max.	
DCLK frequency @Frame rate=60hz	fclk	32.6	39.6	62.4	Mhz
Horizontal display area	thd	800			DCLK
HSYNC period time	th	890	1000	1300	DCLK
HSYNC blanking	thb+thfp	90	200	500	DCLK
Vertical display area	tvd	600			H
VSYNC period time	tv	610	660	800	H
VSYNC blanking	tvb+tvfp	10	60	200	H

HV mode(1)

HV mode					
Horizontal input timing					
Parameter	Symbol	Value			Unit
		Min.	Typ.	Max.	
Horizontal display area	thd	800			DCLK
DCLK frequency@ Frame rate=60hz	fclk	34.5	39.6	50.4	Mhz
1 Horizontal Line	th	900	1000	1200	DCLK
HSYNC pulse width	thpw	Min.	1		
		Typ.	—		
		Max.	40		
HSYNC back porch	thbp	88	88	88	
HSYNC front porch	thfp	12	112	312	

HV mode(2)

Vertical input timing					
Parameter	Symbol	Value			Unit
		Min.	Typ.	Max.	
Vertical display area	tvd	600			H
VSYNC period time	tv	640	660	700	H
VSYNC pulse width	tvpw	1	—	20	H
VSYNC back porch	tvb	39	39	39	H
VSYNC front porch	tvfp	1	21	61	H

6.8.4. For 800RGB x 480 panel

DE mode

DE mode					
Parameter	Symbol	Value			Unit
		Min.	Typ.	Max.	
DCLK frequency @Frame rate=60hz	fclk	26.2	29.2	54.6	Mhz
Horizontal display area	thd	800			DCLK
HSYNC period time	th	890	928	1300	DCLK
HSYNC blanking	thb+thfp	90	128	500	DCLK
Vertical display area	tvd	480			H
VSYNC period time	tv	490	525	700	H
VSYNC blanking	tvb+tvfp	10	45	220	H

HV mode(1)

HV mode					
Horizontal input timing					
Parameter	Symbol	Value			Unit
		Min.	Typ.	Max.	
Horizontal display area	thd	800			DCLK
DCLK frequency@ Frame rate=60hz	fclk	27.7	29.2	39.6	Mhz
1 Horizontal Line	th	900	928	1100	DCLK
HSYNC pulse width	thpw	Min.	1		
		Typ.	—		
		Max.	40		
HSYNC back porch	thbp	88	88	88	
HSYNC front porch	thfp	12	40	212	

HV mode(2)

Vertical input timing					
Parameter	Symbol	Value			Unit
		Min.	Typ.	Max.	
Vertical display area	tvd	480			H
VSYNC period time	tv	513	525	600	H
VSYNC pulse width	tvpw	1	—	3	H
VSYNC back porch	tvb	32	32	32	H
VSYNC front porch	tvfp	1	13	88	H

7. ELECTRICAL SPECIFICATION

7.1. Absolute Maximum Ratings

VOLTAGE (TA = 25°C, GND = AGND = GND_LVDS = 0V)

	Min.	Max.	Unit
Digital Supply Voltage, VDD	-0.5	+5.0	V
Analog Supply Voltage, AVDD, V1~V14	-0.5	+15.0	V

TEMPERATURE

	Min.	Max.	Unit
Operating temperature	-20	+85	°C
Storage temperature	-55	+125	°C

Comments

Stresses above those listed under "Absolute Maximum Ratings" may cause permanent damage to the device. These are stress ratings only. Functional operation of this device at these or any other conditions above those indicated in the operational sections of this specification is not implied and exposed to absolute maximum rating conditions for extended periods may affect device reliability.

7.2. Recommended Operating Range

Recommended Operating Range (TA = -20 to 85°C, GND = AGND = GND_LVDS = 0V)

Parameter	Symbol	Min.	Typ.	Max.	Unit
Digital supply voltage	VDD	2.3	3.3	3.6	V
Analog supply voltage	AVDD	8	-	13.5	V
Digital input voltage	VIN	0	-	VDD	V

7.3. DC Electrical Characteristics

DC Characteristics

(TA = -20 to 85°C, VDD = 2.3 to 3.6V, AVDD = 8 to 13.5V, GND = AGND = GND_LVDS = 0V)

7.3.1. TTL mode

Parameter	Symbol	Condition	Min.	Typ.	Max.	Unit
Low level input voltage	Vil	For the digital circuit	0	-	0.3×VDD	V
High level input voltage	Vih	For the digital circuit	0.7×VDD	-	VDD	V
Input leakage current	Ii	For the digital circuit	-	-	±1	μA
High level output voltage	Voh	Ioh= -400 μA	VDD-0.4	-	-	V
Low level output voltage	Vol	Iol= +400 μA	-	-	GND+0.4	V
Pull low/high resistor	Ri	For the digital input pin @ VDD=3.3V	200K	250K	300K	ohm
Digital Operation current	Idd	Fclk=65 MHz, FLD=50KHz, VDD=3.3V	-	15	25	mA
Digital Stand-by current	Ist1	Clock and all functions are stopped	-	10	50	μA
Analog Operating Current	Idda	No load, Fclk=65MHz, FLD=50KHz @ AVDD=10V, V1=8V, V14=0.4V	-	10	12	mA
Analog Stand-by current	Ist2	No load, Clock and all functions are Stopped	-	10	50	μA
Input level of V1 ~ V7	Vref1	Gamma correction voltage input	0.4×AVDD	-	AVDD-0.1	V
Input level of V8 ~ V14	Vref2	Gamma correction voltage input	0.1	-	0.6×AVDD	V
Output Voltage deviation	Vod1	Vo = AVSS+0.1V ~ AVSS+0.5V and Vo = AVDD-0.5V ~ AVDD-0.1V	-	±20	±35	mV
Output Voltage deviation	Vod2	Vo = AVSS+0.5V ~ AVDD-0.5V	-	±15	±20	mV
Output Voltage Offset between Chips	Voc	Vo = AVSS+0.5V ~ AVDD-0.5V	-	-	±20	mV
Dynamic Range of Output	Vdr	SO1 ~ SO1536	0.1	-	AVDD-0.1	V
Sinking Current of Outputs	IOLy	SO1 ~ SO1536; Vo=0.1V v.s 1.0V , AVDD=13.5V	80	-	-	uA
Driving Current of Outputs	IOHy	SO1 ~ SO1536; Vo=13.4V v.s 12.5V , AVDD=13.5V	80	-	-	uA
Resistance of Gamma Table	Rg	Rn: Internal gamma resistor	0.7×Rn	1.0×Rn	1.3×Rn	ohm

7.3.2. LVDS mode(Receiver Differential :PIND0~PIND3,NIND0~NIND3,PINC,NINC)

LVDS DC characteristic

Parameter	Symbol	Min.	Typ.	Max.	Unit	Condition
Differential input high threshold voltage	R _{xVTH}			+0.1V	V	R _{xVCM} =1.2V
Differential input low threshold voltage	R _{xVTL}	-0.1			V	
Input voltage range(single-end)	R _{xVIN}	0		2.4	V	
Differential input common mode voltage	R _{xVCM}	V _{ID} /2		2.4 - V _{ID} /2	V	
Differential input voltage	V _{ID}	0.2		0.6	V	
Differential input leakage current	R _{xVTH}	-10		+10	μA	
LVDS Digital Operating Current	I _{ddlvsd}	-	40(TBD)	50	mA	Fclk=65Mhz, VDD=3.3V
LVDS Digital Standby Current	I _{stlvsd}	-	10(TBD)	50	μA	Clock & all functions are stop

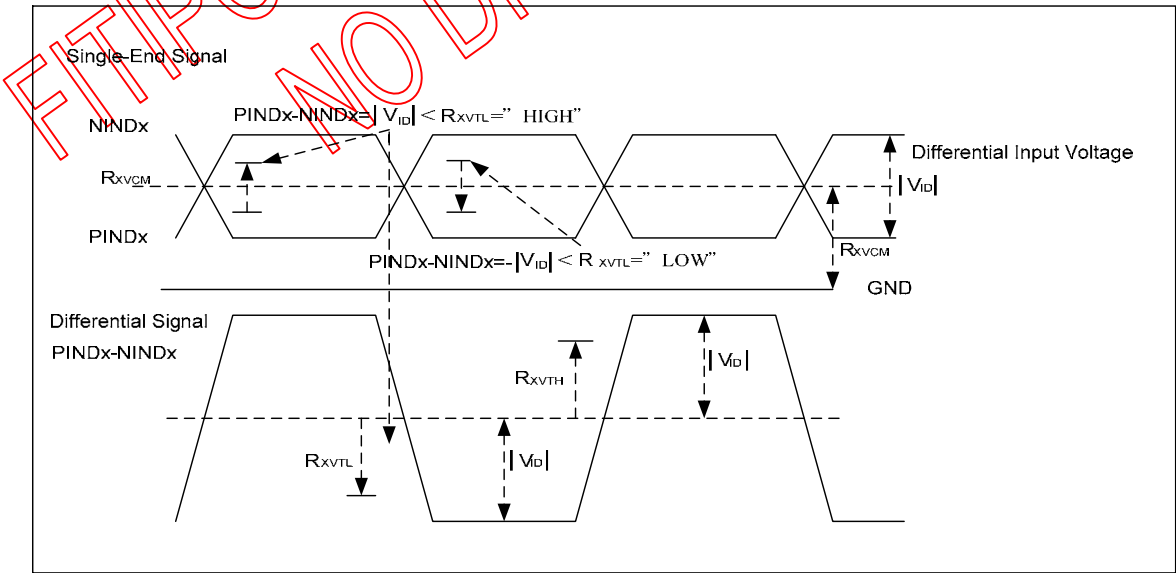

LVDS DC Characteristic

7.3.3. Power

Power

Parameter	Symbol	Min.	Typ.	Max.	Unit	Condition
Base drive current for PWM	IDRV	–	–	60	mA	DRVA = 0.7V
DRV output voltage for PWM	VDRV	0	–	VDD	V	
Feedback voltage for PWM	VFB	1.1	1.2	1.3	V	
Duty cycle maximum	Dmax	–	–	85	%	
VCOM buffer input voltage	VCOMI	1	–	AVDD	V	
VCOM buffer output voltage	VCOMO	VCOMI-0.2	VCOMI	VCOMI+0.2	V	
VCOM buffer output current	IVCOM	–	–	10	mA	VCOMO= 5V vs 4.9V

FITIPOWER CONFIDENTIAL
NO DISCLOSURE

7.4. AC Electrical Characteristics

(TA = -20 to 85°C, VDD = 2.3 to 3.6V, AVDD = 8 to 13.5V, GND = AGND = 0V)

TTL mode

Parameter	Symbol	Condition	Min.	Typ.	Max.	Unit
VDD Power On Slew rate	TPOR	From 0V to 90% VDD	-	-	20	ms
RSTB pulse width	TRST	DCLK = 65MHz	50	-	-	us
DCLK cycle time	Tcph	-	14	-	-	ns
DCLK pulse duty	Tcwh	-	40	50	60	%
VSD setup time	Tvst	-	5	-	-	ns
VSD hold time	Tvhd	-	5	-	-	ns
HSD setup time	Thst	-	5	-	-	ns
HSD hold time	Thhd	-	5	-	-	ns
Data set-up time	Tdsu	D0[7:0], D1[7:0], D2[7:0] to DCLK	5	-	-	ns
Data hold time	Tdhd	D0[7:0], D1[7:0], D2[7:0] to DCLK	5	-	-	ns
DE setup time	Tesu	-	5	-	-	ns
DE hold time	Tehd	-	5	-	-	ns
Output stable time	Tsst	10% to 90% target voltage. CL=90pF, R=10K ohm(Cascade)	-	-	6	us
		Dual gate			3	

LVDS mode

Parameter	Symbol	Condition	Min.	Typ.	Max.	Unit
Clock Frequency	RxFCLK		20	-	71	MHz
Input data skew margin	TRSKM	VID =400mV RxVCM=1.2V RxFCLK=71MHz	500			ps
						ns
Clock High Time	TLVCH			4/(7* RxFCLK)		ns
Clock Low Time	TLVCL			3/(7* RxFCLK)		ns
PLL wake-up-time	TenPLL				150	us

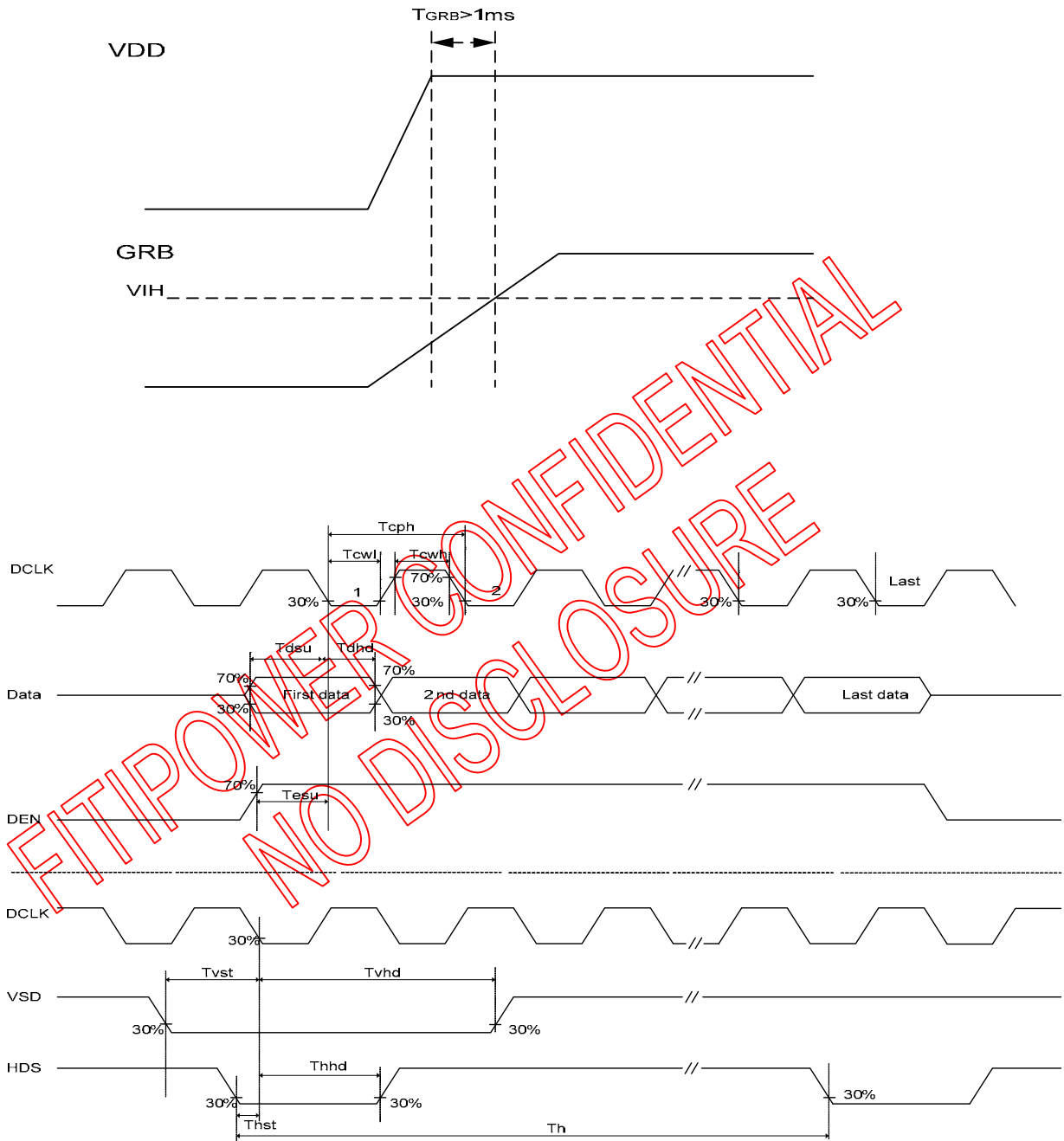

Parallel Input Clock and Data timing

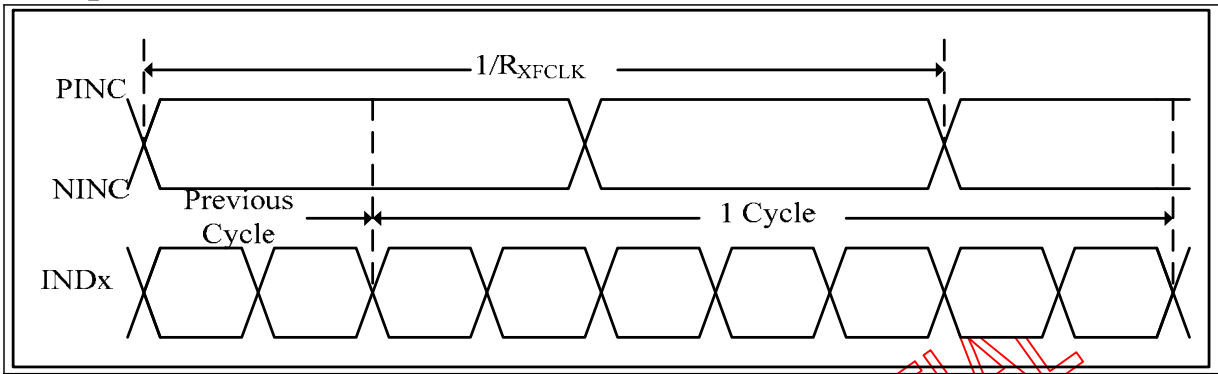

LVDS timing(1)

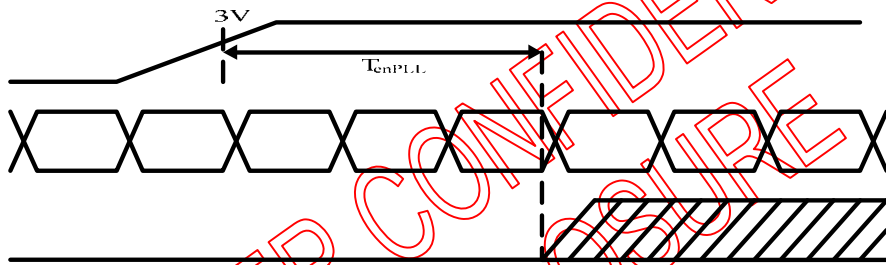

LVDS timing(2)

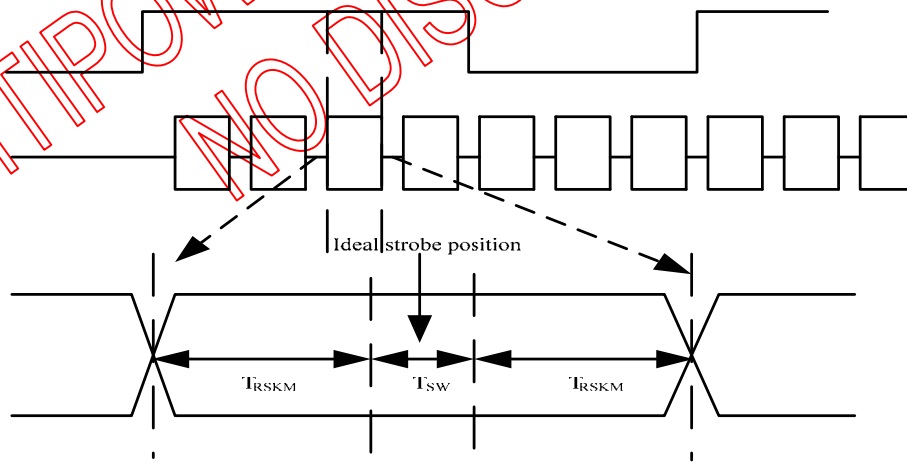

T_{sw} : Receiver strobe position
 T_{RSKM} : Receiver strobe margin

LVDS timing(3)

7.5. Output Timing Table

Output Timing Table

Parameter	Symbol	Min.	Typ.	Max.	Unit	Condition
DCLK frequency	Fclk	-	65	71	MHz	VDD =2.3~3.6V
DCLK cycle time	Tclk	14.1	15.4		ns	
DCLK pulse duty	Tcwh	40	50	60	%	Tclk
Time from HSD to Source Output	Thso	-	64	-	DCLK	
Time from HSD to LD	Thld	-	64	-	DCLK	
Time from HSD to STV	Thstv	-	2	-	DCLK	
Time from HSD to CKV	Thckv	-	20	-	DCLK	
Time from HSD to OEV	Thoev	-	4	-	DCLK	
LD pulse width	Twld	-	10	-	DCLK	
CKV pulse width	Twckv	-	66	-	DCLK	
OEV pulse width	Twoev	-	74	-	DCLK	

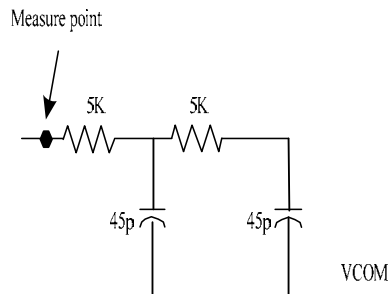
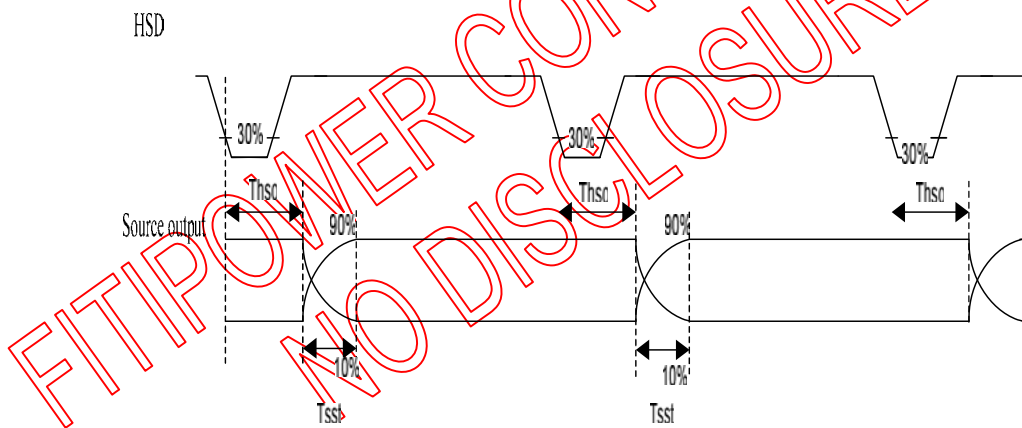

Source Output Timing(Cascade)

7.5.1. Vertical Timing Diagram HV mode(Cascade)

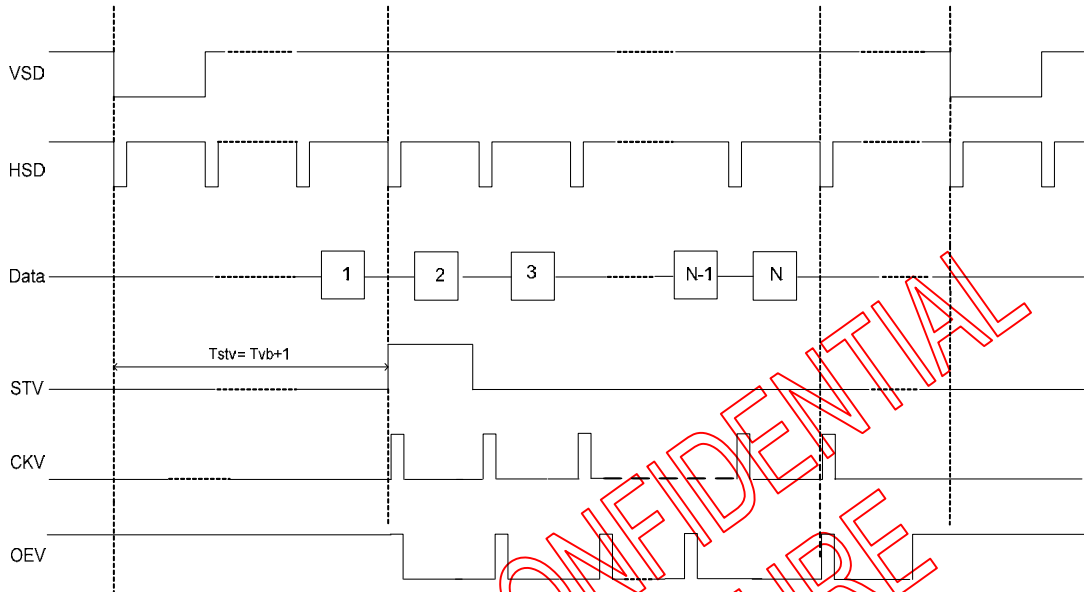

Vertical Timing Diagram HV mode(Cascade)

7.5.2. Vertical Timing Diagram DE mode(Cascade)

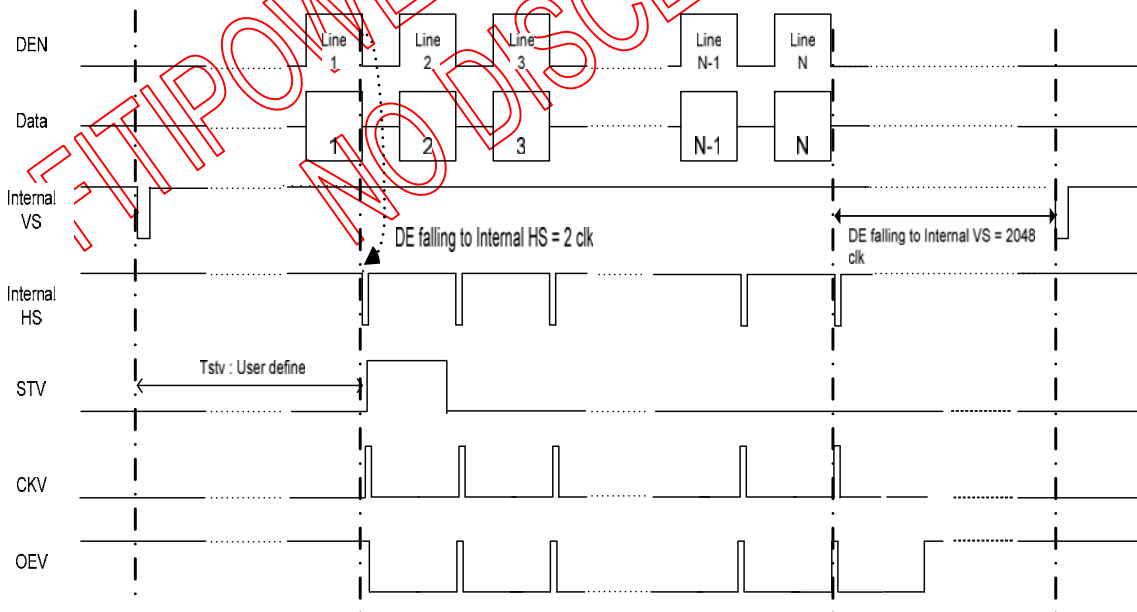

Vertical Timing Diagram DE mode(Cascade)

7.5.3. Gate output timing diagram(Cascade)

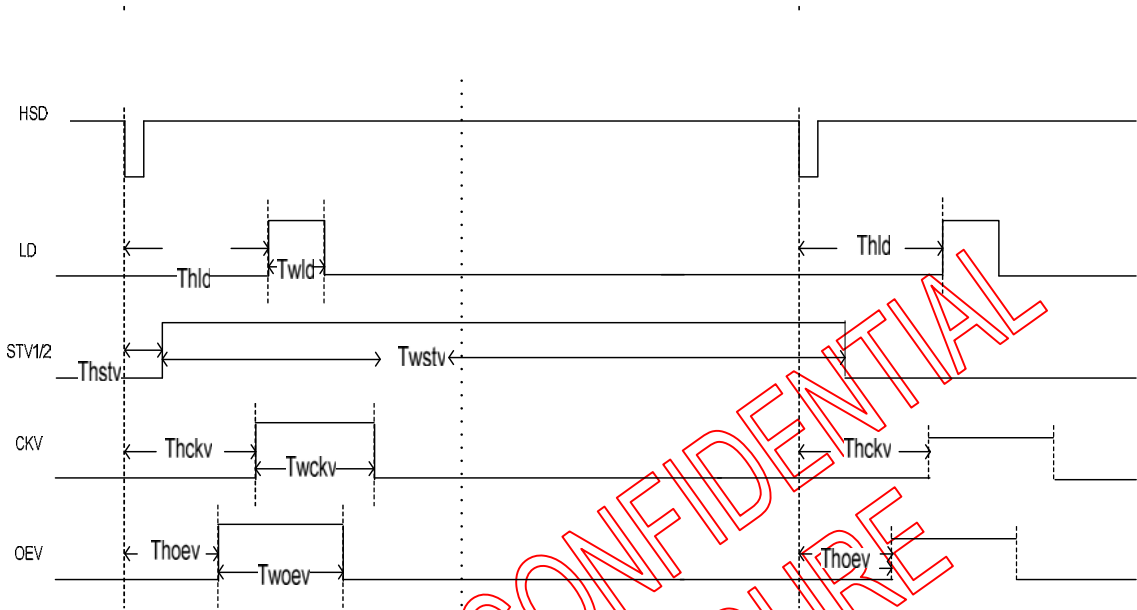

Gate output timing diagram(Cascade)

7.5.4. Vertical Timing Diagram HV mode(Dual Gate)

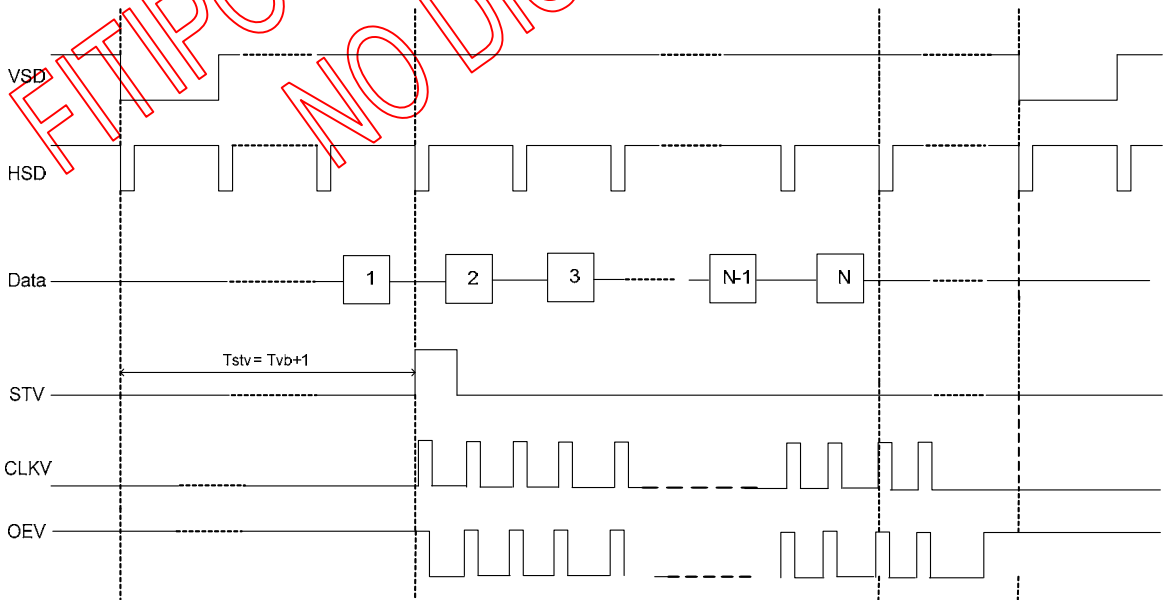

Vertical Timing Diagram HV mode(Dual Gate)

7.5.5. Vertical Timing Diagram DE mode(Dual Gate)

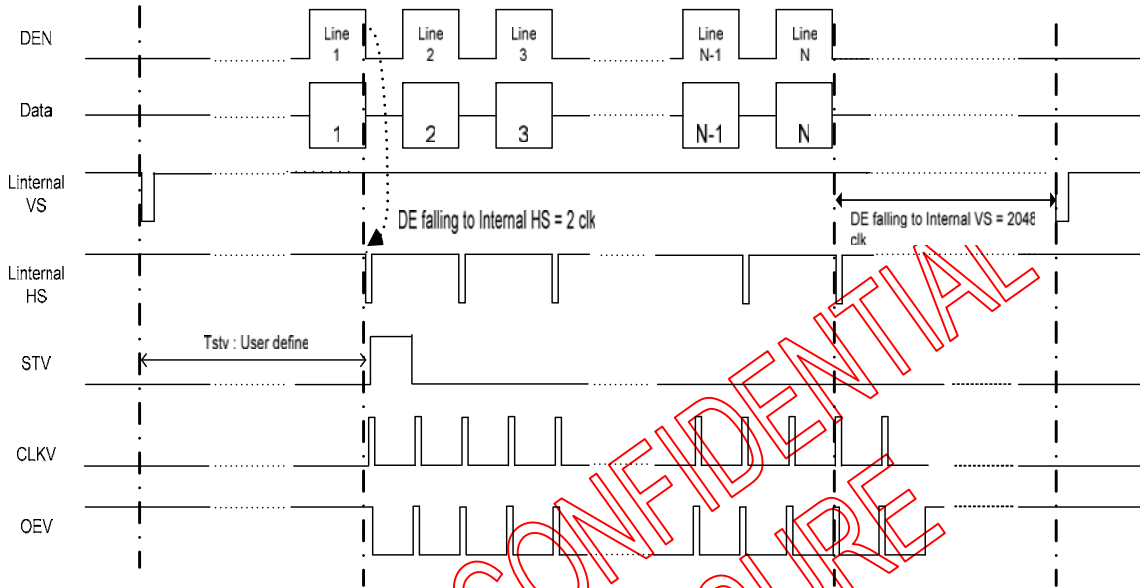

Vertical Timing Diagram DE mode(Dual Gate)

7.5.6. Gate output timing diagram(Dual Gate)

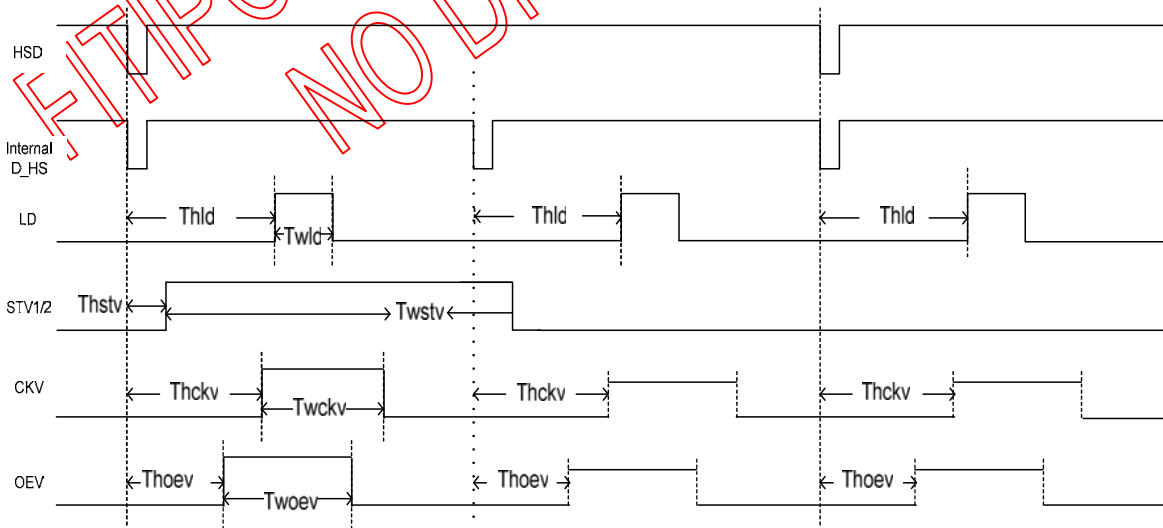

Gate output timing diagram(Dual Gate)

8. SDRRS TIMING DIAGRAM

SDRRS(seamless display refresh rate switching)

When Showing the still picture.it is accept to refresh rate from 60Hz to low refresh rate (for example 40Hz).The purpose is mainly for power saving. INTEL defined a timing chart switch between different refresh rate.Following this timing chart,the switch between different refresh rates is seamless for end user.

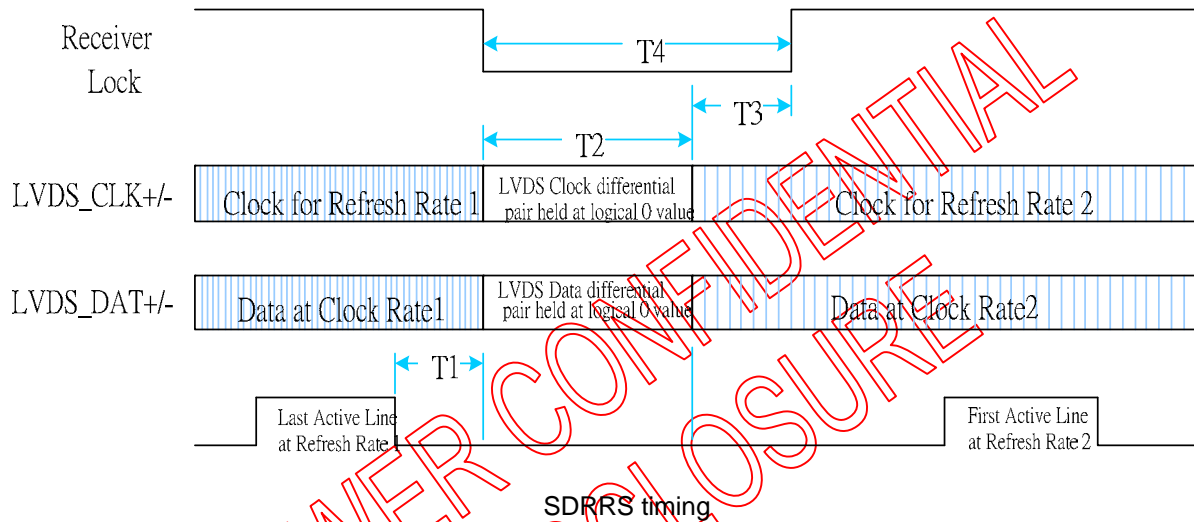

- T1-Min delay from start of vertical blank to start of timing change:2 lines(HSYNC periods)
- T2-Max delay for clock to transition to new frequency:100us
- T3-Max receiver lock delay from stable clock: Display specific
- T4-Max period during which panel maintains display(T2+T3): Display specific

9. CHIP OUTLINE DIMENSIONS

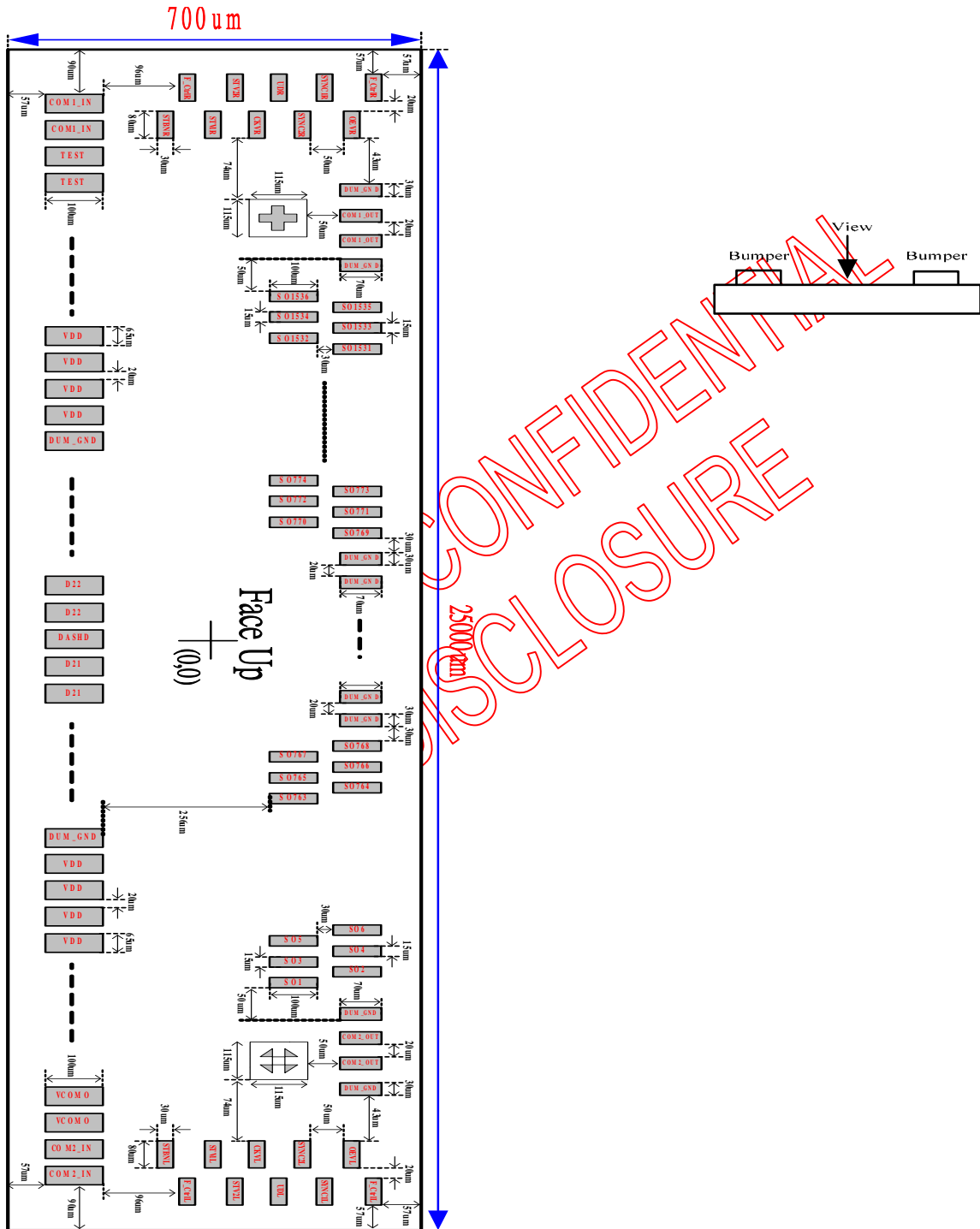

Chip Outline Dimensions

9.1. Alignment Mark

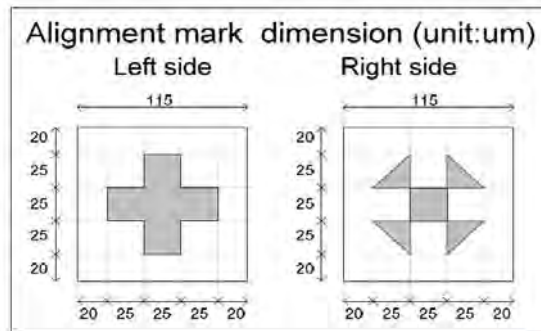

Alignment Mark

9.2. Pad Coordinate

Pad	Text Name	CX	CY	42	NBW	-8892.5	-243	84	SHIELDING	-5322.5	-243
1	COM1_IN	-12377.5	-243	43	PINCTL	-8807.5	-243	85	AGND	-5237.5	-243
2	COM1_IN	-12292.5	-243	44	PINCTL	-8722.5	-243	86	AGND	-5152.5	-243
3	TP	-12207.5	-243	45	SHIELDING	-8637.5	-243	87	AGND	-5067.5	-243
4	TP	-12122.5	-243	46	DIMO	-8552.5	-243	88	AGND	-4982.5	-243
5	TP	-12037.5	-243	47	DIMO	-8467.5	-243	89	SHIELDING	-4897.5	-243
6	TP	-11952.5	-243	48	SHIELDING	-8382.5	-243	90	V1	-4812.5	-243
7	SHIELDING	-11867.5	-243	49	DITHER	-8297.5	-243	91	V1	-4727.5	-243
8	AGND	-11782.5	-243	50	DITHER	-8212.5	-243	92	V2	-4642.5	-243
9	AGND	-11697.5	-243	51	HFERC	-8127.5	-243	93	V2	-4557.5	-243
10	AGND	-11612.5	-243	52	HFERC	-8042.5	-243	94	V3	-4472.5	-243
11	AGND	-11527.5	-243	53	TP	-7957.5	-243	95	V3	-4387.5	-243
12	SHIELDING	-11442.5	-243	54	TP	-7872.5	-243	96	V4	-4302.5	-243
13	AVDD	-11357.5	-243	55	FRAME	-7787.5	-243	97	V4	-4217.5	-243
14	AVDD	-11272.5	-243	56	FRAME	-7702.5	-243	98	V5	-4132.5	-243
15	AVDD	-11187.5	-243	57	SEL[0]	-7617.5	-243	99	V5	-4047.5	-243
16	AVDD	-11102.5	-243	58	SEL[0]	-7532.5	-243	100	V6	-3962.5	-243
17	SHIELDING	-11017.5	-243	59	SEL[1]	-7447.5	-243	101	V6	-3877.5	-243
18	GND	-10932.5	-243	60	SEL[1]	-7362.5	-243	102	V7	-3792.5	-243
19	GND	-10847.5	-243	61	CSB	-7277.5	-243	103	V7	-3707.5	-243
20	GND	-10762.5	-243	62	CSB	-7192.5	-243	104	GAMH	-3622.5	-243
21	GND	-10677.5	-243	63	SHIELDING	-7107.5	-243	105	GAMH	-3537.5	-243
22	SHIELDING	-10592.5	-243	64	SDA	-7022.5	-243	106	SHIELDING	-3452.5	-243
23	VDD	-10507.5	-243	65	SDA	-6937.5	-243	107	DASHD	-3367.5	-243
24	VDD	-10422.5	-243	66	SHIELDING	-6852.5	-243	108	VSD	-3282.5	-243
25	VDD	-10337.5	-243	67	SCL	-6767.5	-243	109	DASHD	-3197.5	-243
26	VDD	-10252.5	-243	68	SCL	-6682.5	-243	110	HSD	-3112.5	-243
27	SHIELDING	-10167.5	-243	69	SHIELDING	-6597.5	-243	111	DASHD	-3027.5	-243
28	TP	-10082.5	-243	70	VDD	-6512.5	-243	112	DEN	-2942.5	-243
29	TP	-9997.5	-243	71	VDD	-6427.5	-243	113	GND_LVDS	-2857.5	-243
30	TP	-9912.5	-243	72	VDD	-6342.5	-243	114	GND_LVDS	-2772.5	-243
31	TP	-9827.5	-243	73	VDD	-6257.5	-243	115	GND_LVDS	-2687.5	-243
32	TP	-9742.5	-243	74	SHIELDING	-6172.5	-243	116	GND_LVDS	-2602.5	-243
33	TP	-9657.5	-243	75	GND	-6087.5	-243	117	D27	-2517.5	-243
34	TP	-9572.5	-243	76	GND	-6002.5	-243	118	D26	-2432.5	-243
35	TP	-9487.5	-243	77	GND	-5917.5	-243	119	DASHD	-2347.5	-243
36	TP	-9402.5	-243	78	GND	-5832.5	-243	120	D25	-2262.5	-243
37	TP	-9317.5	-243	79	SHIELDING	-5747.5	-243	121	D24	-2177.5	-243
38	SHIELDING	-9232.5	-243	80	AVDD	-5662.5	-243	122	DASHD	-2092.5	-243
39	DIMI	-9147.5	-243	81	AVDD	-5577.5	-243	123	D23	-2007.5	-243
40	DIMI	-9062.5	-243	82	AVDD	-5492.5	-243	124	D22	-1922.5	-243
41	NBW	-8977.5	-243	83	AVDD	-5407.5	-243	125	DASHD	-1837.5	-243

126	D21	-1752.5	-243	192	GND	3857.5	-243	258	AVDD	9467.5	-243
127	D20	-1667.5	-243	193	GND	3942.5	-243	259	AVDD	9552.5	-243
128	DASHD	-1582.5	-243	194	SHIELDING	4027.5	-243	260	AVDD	9637.5	-243
129	DCLK	-1497.5	-243	195	VDD	4112.5	-243	261	AVDD	9722.5	-243
130	NINC	-1412.5	-243	196	VDD	4197.5	-243	262	SHIELDING	9807.5	-243
131	DASHD	-1327.5	-243	197	VDD	4282.5	-243	263	AGND	9892.5	-243
132	VDD_LVDS	-1242.5	-243	198	VDD	4367.5	-243	264	AGND	9977.5	-243
133	VDD_LVDS	-1157.5	-243	199	SHIELDING	4452.5	-243	265	AGND	10062.5	-243
134	VDD_LVDS	-1072.5	-243	200	DUAL	4537.5	-243	266	AGND	10147.5	-243
135	VDD_LVDS	-987.5	-243	201	DUAL	4622.5	-243	267	SHIELDING	10232.5	-243
136	REV	-902.5	-243	202	MASL	4707.5	-243	268	TP	10317.5	-243
137	DASHD	-817.5	-243	203	MASL	4792.5	-243	269	VCOMI	10402.5	-243
138	D17	-732.5	-243	204	MASLOC	4877.5	-243	270	VCOMI	10487.5	-243
139	D16	-647.5	-243	205	MASLOC	4962.5	-243	271	PWR_EN	10572.5	-243
140	DASHD	-562.5	-243	206	CABC_EN[0]	5047.5	-243	272	PWR_EN	10657.5	-243
141	D15	-477.5	-243	207	CABC_EN[0]	5132.5	-243	273	FBL	10742.5	-243
142	D14	-392.5	-243	208	CABC_EN[1]	5217.5	-243	274	FBL	10827.5	-243
143	DASHD	-307.5	-243	209	CABC_EN[1]	5302.5	-243	275	FBH	10912.5	-243
144	D13	-222.5	-243	210	OPDRV	5387.5	-243	276	FBH	10997.5	-243
145	D12	-137.5	-243	211	OPDRV	5472.5	-243	277	FBA	11082.5	-243
146	DASHD	-52.5	-243	212	MODE	5557.5	-243	278	FBA	11167.5	-243
147	D11	32.5	-243	213	MODE	5642.5	-243	279	AVDDG	11252.5	-243
148	D10	117.5	-243	214	IFSEL	5727.5	-243	280	AVDDG	11337.5	-243
149	DASHD	202.5	-243	215	IFSEL	5812.5	-243	281	DRVA	11422.5	-243
150	D07	287.5	-243	216	BIST	5897.5	-243	282	DRVA	11507.5	-243
151	D06	372.5	-243	217	BIST	5982.5	-243	283	DRVH	11592.5	-243
152	DASHD	457.5	-243	218	RES[0]	6067.5	-243	284	DRVH	11677.5	-243
153	D05	542.5	-243	219	RES[0]	6152.5	-243	285	DRVL	11762.5	-243
154	D04	627.5	-243	220	RES[1]	6237.5	-243	286	DRVL	11847.5	-243
155	DASHD	712.5	-243	221	RES[1]	6322.5	-243	287	DRVL_B	11932.5	-243
156	D03	797.5	-243	222	DCLKPOL	6407.5	-243	288	DRVL_B	12017.5	-243
157	D02	882.5	-243	223	DCLKPOL	6492.5	-243	289	VCOMO	12102.5	-243
158	DASHD	967.5	-243	224	STBYB	6577.5	-243	290	VCOMO	12187.5	-243
159	D01	1052.5	-243	225	STBYB	6662.5	-243	291	COM2_IN	12272.5	-243
160	D00	1137.5	-243	226	GRB	6747.5	-243	292	COM2_IN	12357.5	-243
161	DASHD	1222.5	-243	227	GRB	6832.5	-243	293	STBNL	12303.0	-82
162	SHIELDING	1307.5	-243	228	SHLR	6917.5	-243	294	F_CtrlL	12403.0	-42
163	GAML	1392.5	-243	229	SHLR	7002.5	-243	295	STV2L	12303.0	-2
164	GAML	1477.5	-243	230	UPDN	7087.5	-243	296	STV1L	12403.0	38
165	V8	1562.5	-243	231	UPDN	7172.5	-243	297	CKVL	12303.0	78
166	V8	1647.5	-243	232	SHIELDING	7257.5	-243	298	UDL	12403.0	118
167	V9	1732.5	-243	233	TP	7342.5	-243	299	SYNC2L	12303.0	158
168	V9	1817.5	-243	234	TP	7427.5	-243	300	SYNC1L	12403.0	198
169	V10	1902.5	-243	235	TP	7512.5	-243	301	OEVL	12303.0	238
170	V10	1987.5	-243	236	TP	7597.5	-243	302	F_CtrlL	12403.0	278
171	V11	2072.5	-243	237	TP	7682.5	-243	303	SHIELDING	12205.0	258
172	V11	2157.5	-243	238	TP	7767.5	-243	304	COM2_OUT	12155.0	258
173	V12	2242.5	-243	239	TP	7852.5	-243	305	COM2_OUT	12105.0	258
174	V12	2327.5	-243	240	TP	7937.5	-243	306	SHIELDING	12055.0	258
175	V13	2412.5	-243	241	TP	8022.5	-243	307	SO1	12012.5	113
176	V13	2497.5	-243	242	TP	8107.5	-243	308	SO2	11997.5	243
177	V14	2582.5	-243	243	TP	8192.5	-243	309	SO3	11982.5	113
178	V14	2667.5	-243	244	TP	8277.5	-243	310	SO4	11967.5	243
179	SHIELDING	2752.5	-243	245	TP	8362.5	-243	311	SO5	11952.5	113
180	AGND	2837.5	-243	246	TP	8447.5	-243	312	SO6	11937.5	243
181	AGND	2922.5	-243	247	SHIELDING	8532.5	-243	313	SO7	11922.5	113
182	AGND	3007.5	-243	248	VDD	8617.5	-243	314	SO8	11907.5	243
183	AGND	3092.5	-243	249	VDD	8702.5	-243	315	SO9	11892.5	113
184	SHIELDING	3177.5	-243	250	VDD	8787.5	-243	316	SO10	11877.5	243
185	AVDD	3262.5	-243	251	VDD	8872.5	-243	317	SO11	11862.5	113
186	AVDD	3347.5	-243	252	SHIELDING	8957.5	-243	318	SO12	11847.5	243
187	AVDD	3432.5	-243	253	GND	9042.5	-243	319	SO13	11832.5	113
188	AVDD	3517.5	-243	254	GND	9127.5	-243	320	SO14	11817.5	243
189	SHIELDING	3602.5	-243	255	GND	9212.5	-243	321	SO15	11802.5	113
190	GND	3687.5	-243	256	GND	9297.5	-243	322	SO16	11787.5	243
191	GND	3772.5	-243	257	SHIELDING	9382.5	-243	323	SO17	11772.5	113

324	SO18	11757.5	243	390	SO84	10767.5	243	456	SO150	9777.5	243
325	SO19	11742.5	113	391	SO85	10752.5	113	457	SO151	9762.5	113
326	SO20	11727.5	243	392	SO86	10737.5	243	458	SO152	9747.5	243
327	SO21	11712.5	113	393	SO87	10722.5	113	459	SO153	9732.5	113
328	SO22	11697.5	243	394	SO88	10707.5	243	460	SO154	9717.5	243
329	SO23	11682.5	113	395	SO89	10692.5	113	461	SO155	9702.5	113
330	SO24	11667.5	243	396	SO90	10677.5	243	462	SO156	9687.5	243
331	SO25	11652.5	113	397	SO91	10662.5	113	463	SO157	9672.5	113
332	SO26	11637.5	243	398	SO92	10647.5	243	464	SO158	9657.5	243
333	SO27	11622.5	113	399	SO93	10632.5	113	465	SO159	9642.5	113
334	SO28	11607.5	243	400	SO94	10617.5	243	466	SO160	9627.5	243
335	SO29	11592.5	113	401	SO95	10602.5	113	467	SO161	9612.5	113
336	SO30	11577.5	243	402	SO96	10587.5	243	468	SO162	9597.5	243
337	SO31	11562.5	113	403	SO97	10572.5	113	469	SO163	9582.5	113
338	SO32	11547.5	243	404	SO98	10557.5	243	470	SO164	9567.5	243
339	SO33	11532.5	113	405	SO99	10542.5	113	471	SO165	9552.5	113
340	SO34	11517.5	243	406	SO100	10527.5	243	472	SO166	9537.5	243
341	SO35	11502.5	113	407	SO101	10512.5	113	473	SO167	9522.5	113
342	SO36	11487.5	243	408	SO102	10497.5	243	474	SO168	9507.5	243
343	SO37	11472.5	113	409	SO103	10482.5	113	475	SO169	9492.5	113
344	SO38	11457.5	243	410	SO104	10467.5	243	476	SO170	9477.5	243
345	SO39	11442.5	113	411	SO105	10452.5	113	477	SO171	9462.5	113
346	SO40	11427.5	243	412	SO106	10437.5	243	478	SO172	9447.5	243
347	SO41	11412.5	113	413	SO107	10422.5	113	479	SO173	9432.5	113
348	SO42	11397.5	243	414	SO108	10407.5	243	480	SO174	9417.5	243
349	SO43	11382.5	113	415	SO109	10392.5	113	481	SO175	9402.5	113
350	SO44	11367.5	243	416	SO110	10377.5	243	482	SO176	9387.5	243
351	SO45	11352.5	113	417	SO111	10362.5	113	483	SO177	9372.5	113
352	SO46	11337.5	243	418	SO112	10347.5	243	484	SO178	9357.5	243
353	SO47	11322.5	113	419	SO113	10332.5	113	485	SO179	9342.5	113
354	SO48	11307.5	243	420	SO114	10317.5	243	486	SO180	9327.5	243
355	SO49	11292.5	113	421	SO115	10302.5	113	487	SO181	9312.5	113
356	SO50	11277.5	243	422	SO116	10287.5	243	488	SO182	9297.5	243
357	SO51	11262.5	113	423	SO117	10272.5	113	489	SO183	9282.5	113
358	SO52	11247.5	243	424	SO118	10257.5	243	490	SO184	9267.5	243
359	SO53	11232.5	113	425	SO119	10242.5	113	491	SO185	9252.5	113
360	SO54	11217.5	243	426	SO120	10227.5	243	492	SO186	9237.5	243
361	SO55	11202.5	113	427	SO121	10212.5	113	493	SO187	9222.5	113
362	SO56	11187.5	243	428	SO122	10197.5	243	494	SO188	9207.5	243
363	SO57	11172.5	113	429	SO123	10182.5	113	495	SO189	9192.5	113
364	SO58	11157.5	243	430	SO124	10167.5	243	496	SO190	9177.5	243
365	SO59	11142.5	113	431	SO125	10152.5	113	497	SO191	9162.5	113
366	SO60	11127.5	243	432	SO126	10137.5	243	498	SO192	9147.5	243
367	SO61	11112.5	113	433	SO127	10122.5	113	499	SO193	9132.5	113
368	SO62	11097.5	243	434	SO128	10107.5	243	500	SO194	9117.5	243
369	SO63	11082.5	113	435	SO129	10092.5	113	501	SO195	9102.5	113
370	SO64	11067.5	243	436	SO130	10077.5	243	502	SO196	9087.5	243
371	SO65	11052.5	113	437	SO131	10062.5	113	503	SO197	9072.5	113
372	SO66	11037.5	243	438	SO132	10047.5	243	504	SO198	9057.5	243
373	SO67	11022.5	113	439	SO133	10032.5	113	505	SO199	9042.5	113
374	SO68	11007.5	243	440	SO134	10017.5	243	506	SO200	9027.5	243
375	SO69	10992.5	113	441	SO135	10002.5	113	507	SO201	9012.5	113
376	SO70	10977.5	243	442	SO136	9987.5	243	508	SO202	8997.5	243
377	SO71	10962.5	113	443	SO137	9972.5	113	509	SO203	8982.5	113
378	SO72	10947.5	243	444	SO138	9957.5	243	510	SO204	8967.5	243
379	SO73	10932.5	113	445	SO139	9942.5	113	511	SO205	8952.5	113
380	SO74	10917.5	243	446	SO140	9927.5	243	512	SO206	8937.5	243
381	SO75	10902.5	113	447	SO141	9912.5	113	513	SO207	8922.5	113
382	SO76	10887.5	243	448	SO142	9897.5	243	514	SO208	8907.5	243
383	SO77	10872.5	113	449	SO143	9882.5	113	515	SO209	8892.5	113
384	SO78	10857.5	243	450	SO144	9867.5	243	516	SO210	8877.5	243
385	SO79	10842.5	113	451	SO145	9852.5	113	517	SO211	8862.5	113
386	SO80	10827.5	243	452	SO146	9837.5	243	518	SO212	8847.5	243
387	SO81	10812.5	113	453	SO147	9822.5	113	519	SO213	8832.5	113
388	SO82	10797.5	243	454	SO148	9807.5	243	520	SO214	8817.5	243
389	SO83	10782.5	113	455	SO149	9792.5	113	521	SO215	8802.5	113

522	SO216	8787.5	243	588	SO282	7797.5	243	654	SO348	6807.5	243
523	SO217	8772.5	113	589	SO283	7782.5	113	655	SO349	6792.5	113
524	SO218	8757.5	243	590	SO284	7767.5	243	656	SO350	6777.5	243
525	SO219	8742.5	113	591	SO285	7752.5	113	657	SO351	6762.5	113
526	SO220	8727.5	243	592	SO286	7737.5	243	658	SO352	6747.5	243
527	SO221	8712.5	113	593	SO287	7722.5	113	659	SO353	6732.5	113
528	SO222	8697.5	243	594	SO288	7707.5	243	660	SO354	6717.5	243
529	SO223	8682.5	113	595	SO289	7692.5	113	661	SO355	6702.5	113
530	SO224	8667.5	243	596	SO290	7677.5	243	662	SO356	6687.5	243
531	SO225	8652.5	113	597	SO291	7662.5	113	663	SO357	6672.5	113
532	SO226	8637.5	243	598	SO292	7647.5	243	664	SO358	6657.5	243
533	SO227	8622.5	113	599	SO293	7632.5	113	665	SO359	6642.5	113
534	SO228	8607.5	243	600	SO294	7617.5	243	666	SO360	6627.5	243
535	SO229	8592.5	113	601	SO295	7602.5	113	667	SO361	6612.5	113
536	SO230	8577.5	243	602	SO296	7587.5	243	668	SO362	6597.5	243
537	SO231	8562.5	113	603	SO297	7572.5	113	669	SO363	6582.5	113
538	SO232	8547.5	243	604	SO298	7557.5	243	670	SO364	6567.5	243
539	SO233	8532.5	113	605	SO299	7542.5	113	671	SO365	6552.5	113
540	SO234	8517.5	243	606	SO300	7527.5	243	672	SO366	6537.5	243
541	SO235	8502.5	113	607	SO301	7512.5	113	673	SO367	6522.5	113
542	SO236	8487.5	243	608	SO302	7497.5	243	674	SO368	6507.5	243
543	SO237	8472.5	113	609	SO303	7482.5	113	675	SO369	6492.5	113
544	SO238	8457.5	243	610	SO304	7467.5	243	676	SO370	6477.5	243
545	SO239	8442.5	113	611	SO305	7452.5	113	677	SO371	6462.5	113
546	SO240	8427.5	243	612	SO306	7437.5	243	678	SO372	6447.5	243
547	SO241	8412.5	113	613	SO307	7422.5	113	679	SO373	6432.5	113
548	SO242	8397.5	243	614	SO308	7407.5	243	680	SO374	6417.5	243
549	SO243	8382.5	113	615	SO309	7392.5	113	681	SO375	6402.5	113
550	SO244	8367.5	243	616	SO310	7377.5	243	682	SO376	6387.5	243
551	SO245	8352.5	113	617	SO311	7362.5	113	683	SO377	6372.5	113
552	SO246	8337.5	243	618	SO312	7347.5	243	684	SO378	6357.5	243
553	SO247	8322.5	113	619	SO313	7332.5	113	685	SO379	6342.5	113
554	SO248	8307.5	243	620	SO314	7317.5	243	686	SO380	6327.5	243
555	SO249	8292.5	113	621	SO315	7302.5	113	687	SO381	6312.5	113
556	SO250	8277.5	243	622	SO316	7287.5	243	688	SO382	6297.5	243
557	SO251	8262.5	113	623	SO317	7272.5	113	689	SO383	6282.5	113
558	SO252	8247.5	243	624	SO318	7257.5	243	690	SO384	6267.5	243
559	SO253	8232.5	113	625	SO319	7242.5	113	691	SO385	6252.5	113
560	SO254	8217.5	243	626	SO320	7227.5	243	692	SO386	6237.5	243
561	SO255	8202.5	113	627	SO321	7212.5	113	693	SO387	6222.5	113
562	SO256	8187.5	243	628	SO322	7197.5	243	694	SO388	6207.5	243
563	SO257	8172.5	113	629	SO323	7182.5	113	695	SO389	6192.5	113
564	SO258	8157.5	243	630	SO324	7167.5	243	696	SO390	6177.5	243
565	SO259	8142.5	113	631	SO325	7152.5	113	697	SO391	6162.5	113
566	SO260	8127.5	243	632	SO326	7137.5	243	698	SO392	6147.5	243
567	SO261	8112.5	113	633	SO327	7122.5	113	699	SO393	6132.5	113
568	SO262	8097.5	243	634	SO328	7107.5	243	700	SO394	6117.5	243
569	SO263	8082.5	113	635	SO329	7092.5	113	701	SO395	6102.5	113
570	SO264	8067.5	243	636	SO330	7077.5	243	702	SO396	6087.5	243
571	SO265	8052.5	113	637	SO331	7062.5	113	703	SO397	6072.5	113
572	SO266	8037.5	243	638	SO332	7047.5	243	704	SO398	6057.5	243
573	SO267	8022.5	113	639	SO333	7032.5	113	705	SO399	6042.5	113
574	SO268	8007.5	243	640	SO334	7017.5	243	706	SO400	6027.5	243
575	SO269	7992.5	113	641	SO335	7002.5	113	707	SO401	6012.5	113
576	SO270	7977.5	243	642	SO336	6987.5	243	708	SO402	5997.5	243
577	SO271	7962.5	113	643	SO337	6972.5	113	709	SO403	5982.5	113
578	SO272	7947.5	243	644	SO338	6957.5	243	710	SO404	5967.5	243
579	SO273	7932.5	113	645	SO339	6942.5	113	711	SO405	5952.5	113
580	SO274	7917.5	243	646	SO340	6927.5	243	712	SO406	5937.5	243
581	SO275	7902.5	113	647	SO341	6912.5	113	713	SO407	5922.5	113
582	SO276	7887.5	243	648	SO342	6897.5	243	714	SO408	5907.5	243
583	SO277	7872.5	113	649	SO343	6882.5	113	715	SO409	5892.5	113
584	SO278	7857.5	243	650	SO344	6867.5	243	716	SO410	5877.5	243
585	SO279	7842.5	113	651	SO345	6852.5	113	717	SO411	5862.5	113
586	SO280	7827.5	243	652	SO346	6837.5	243	718	SO412	5847.5	243
587	SO281	7812.5	113	653	SO347	6822.5	113	719	SO413	5832.5	113

720	SO414	5817.5	243	786	SO480	4827.5	243	852	SO546	3837.5	243
721	SO415	5802.5	113	787	SO481	4812.5	113	853	SO547	3822.5	113
722	SO416	5787.5	243	788	SO482	4797.5	243	854	SO548	3807.5	243
723	SO417	5772.5	113	789	SO483	4782.5	113	855	SO549	3792.5	113
724	SO418	5757.5	243	790	SO484	4767.5	243	856	SO550	3777.5	243
725	SO419	5742.5	113	791	SO485	4752.5	113	857	SO551	3762.5	113
726	SO420	5727.5	243	792	SO486	4737.5	243	858	SO552	3747.5	243
727	SO421	5712.5	113	793	SO487	4722.5	113	859	SO553	3732.5	113
728	SO422	5697.5	243	794	SO488	4707.5	243	860	SO554	3717.5	243
729	SO423	5682.5	113	795	SO489	4692.5	113	861	SO555	3702.5	113
730	SO424	5667.5	243	796	SO490	4677.5	243	862	SO556	3687.5	243
731	SO425	5652.5	113	797	SO491	4662.5	113	863	SO557	3672.5	113
732	SO426	5637.5	243	798	SO492	4647.5	243	864	SO558	3657.5	243
733	SO427	5622.5	113	799	SO493	4632.5	113	865	SO559	3642.5	113
734	SO428	5607.5	243	800	SO494	4617.5	243	866	SO560	3627.5	243
735	SO429	5592.5	113	801	SO495	4602.5	113	867	SO561	3612.5	113
736	SO430	5577.5	243	802	SO496	4587.5	243	868	SO562	3597.5	243
737	SO431	5562.5	113	803	SO497	4572.5	113	869	SO563	3582.5	113
738	SO432	5547.5	243	804	SO498	4557.5	243	870	SO564	3567.5	243
739	SO433	5532.5	113	805	SO499	4542.5	113	871	SO565	3552.5	113
740	SO434	5517.5	243	806	SO500	4527.5	243	872	SO566	3537.5	243
741	SO435	5502.5	113	807	SO501	4512.5	113	873	SO567	3522.5	113
742	SO436	5487.5	243	808	SO502	4497.5	243	874	SO568	3507.5	243
743	SO437	5472.5	113	809	SO503	4482.5	113	875	SO569	3492.5	113
744	SO438	5457.5	243	810	SO504	4467.5	243	876	SO570	3477.5	243
745	SO439	5442.5	113	811	SO505	4452.5	113	877	SO571	3462.5	113
746	SO440	5427.5	243	812	SO506	4437.5	243	878	SO572	3447.5	243
747	SO441	5412.5	113	813	SO507	4422.5	113	879	SO573	3432.5	113
748	SO442	5397.5	243	814	SO508	4407.5	243	880	SO574	3417.5	243
749	SO443	5382.5	113	815	SO509	4392.5	113	881	SO575	3402.5	113
750	SO444	5367.5	243	816	SO510	4377.5	243	882	SO576	3387.5	243
751	SO445	5352.5	113	817	SO511	4362.5	113	883	SO577	3372.5	113
752	SO446	5337.5	243	818	SO512	4347.5	243	884	SO578	3357.5	243
753	SO447	5322.5	113	819	SO513	4332.5	113	885	SO579	3342.5	113
754	SO448	5307.5	243	820	SO514	4317.5	243	886	SO580	3327.5	243
755	SO449	5292.5	113	821	SO515	4302.5	113	887	SO581	3312.5	113
756	SO450	5277.5	243	822	SO516	4287.5	243	888	SO582	3297.5	243
757	SO451	5262.5	113	823	SO517	4272.5	113	889	SO583	3282.5	113
758	SO452	5247.5	243	824	SO518	4257.5	243	890	SO584	3267.5	243
759	SO453	5232.5	113	825	SO519	4242.5	113	891	SO585	3252.5	113
760	SO454	5217.5	243	826	SO520	4227.5	243	892	SO586	3237.5	243
761	SO455	5202.5	113	827	SO521	4212.5	113	893	SO587	3222.5	113
762	SO456	5187.5	243	828	SO522	4197.5	243	894	SO588	3207.5	243
763	SO457	5172.5	113	829	SO523	4182.5	113	895	SO589	3192.5	113
764	SO458	5157.5	243	830	SO524	4167.5	243	896	SO590	3177.5	243
765	SO459	5142.5	113	831	SO525	4152.5	113	897	SO591	3162.5	113
766	SO460	5127.5	243	832	SO526	4137.5	243	898	SO592	3147.5	243
767	SO461	5112.5	113	833	SO527	4122.5	113	899	SO593	3132.5	113
768	SO462	5097.5	243	834	SO528	4107.5	243	900	SO594	3117.5	243
769	SO463	5082.5	113	835	SO529	4092.5	113	901	SO595	3102.5	113
770	SO464	5067.5	243	836	SO530	4077.5	243	902	SO596	3087.5	243
771	SO465	5052.5	113	837	SO531	4062.5	113	903	SO597	3072.5	113
772	SO466	5037.5	243	838	SO532	4047.5	243	904	SO598	3057.5	243
773	SO467	5022.5	113	839	SO533	4032.5	113	905	SO599	3042.5	113
774	SO468	5007.5	243	840	SO534	4017.5	243	906	SO600	3027.5	243
775	SO469	4992.5	113	841	SO535	4002.5	113	907	SO601	3012.5	113
776	SO470	4977.5	243	842	SO536	3987.5	243	908	SO602	2997.5	243
777	SO471	4962.5	113	843	SO537	3972.5	113	909	SO603	2982.5	113
778	SO472	4947.5	243	844	SO538	3957.5	243	910	SO604	2967.5	243
779	SO473	4932.5	113	845	SO539	3942.5	113	911	SO605	2952.5	113
780	SO474	4917.5	243	846	SO540	3927.5	243	912	SO606	2937.5	243
781	SO475	4902.5	113	847	SO541	3912.5	113	913	SO607	2922.5	113
782	SO476	4887.5	243	848	SO542	3897.5	243	914	SO608	2907.5	243
783	SO477	4872.5	113	849	SO543	3882.5	113	915	SO609	2892.5	113
784	SO478	4857.5	243	850	SO544	3867.5	243	916	SO610	2877.5	243
785	SO479	4842.5	113	851	SO545	3852.5	113	917	SO611	2862.5	113

918	SO612	2847.5	243	984	SO678	1857.5	243	1050	SO744	867.5	243
919	SO613	2832.5	113	985	SO679	1842.5	113	1051	SO745	852.5	113
920	SO614	2817.5	243	986	SO680	1827.5	243	1052	SO746	837.5	243
921	SO615	2802.5	113	987	SO681	1812.5	113	1053	SO747	822.5	113
922	SO616	2787.5	243	988	SO682	1797.5	243	1054	SO748	807.5	243
923	SO617	2772.5	113	989	SO683	1782.5	113	1055	SO749	792.5	113
924	SO618	2757.5	243	990	SO684	1767.5	243	1056	SO750	777.5	243
925	SO619	2742.5	113	991	SO685	1752.5	113	1057	SO751	762.5	113
926	SO620	2727.5	243	992	SO686	1737.5	243	1058	SO752	747.5	243
927	SO621	2712.5	113	993	SO687	1722.5	113	1059	SO753	732.5	113
928	SO622	2697.5	243	994	SO688	1707.5	243	1060	SO754	717.5	243
929	SO623	2682.5	113	995	SO689	1692.5	113	1061	SO755	702.5	113
930	SO624	2667.5	243	996	SO690	1677.5	243	1062	SO756	687.5	243
931	SO625	2652.5	113	997	SO691	1662.5	113	1063	SO757	672.5	113
932	SO626	2637.5	243	998	SO692	1647.5	243	1064	SO758	657.5	243
933	SO627	2622.5	113	999	SO693	1632.5	113	1065	SO759	642.5	113
934	SO628	2607.5	243	1000	SO694	1617.5	243	1066	SO760	627.5	243
935	SO629	2592.5	113	1001	SO695	1602.5	113	1067	SO761	612.5	113
936	SO630	2577.5	243	1002	SO696	1587.5	243	1068	SO762	597.5	243
937	SO631	2562.5	113	1003	SO697	1572.5	113	1069	SO763	582.5	113
938	SO632	2547.5	243	1004	SO698	1557.5	243	1070	SO764	567.5	243
939	SO633	2532.5	113	1005	SO699	1542.5	113	1071	SO765	552.5	113
940	SO634	2517.5	243	1006	SO700	1527.5	243	1072	SO766	537.5	243
941	SO635	2502.5	113	1007	SO701	1512.5	113	1073	SO767	522.5	113
942	SO636	2487.5	243	1008	SO702	1497.5	243	1074	SO768	507.5	243
943	SO637	2472.5	113	1009	SO703	1482.5	113	1075	SHIELDING	455.0	258
944	SO638	2457.5	243	1010	SO704	1467.5	243	1076	SHIELDING	405.0	258
945	SO639	2442.5	113	1011	SO705	1452.5	113	1077	SHIELDING	355.0	258
946	SO640	2427.5	243	1012	SO706	1437.5	243	1078	SHIELDING	50.0	258
947	SO641	2412.5	113	1013	SO707	1422.5	113	1079	SHIELDING	0.0	258
948	SO642	2397.5	243	1014	SO708	1407.5	243	1080	SHIELDING	-50.0	258
949	SO643	2382.5	113	1015	SO709	1392.5	113	1081	SHIELDING	-355.0	258
950	SO644	2367.5	243	1016	SO710	1377.5	243	1082	SHIELDING	-405.0	258
951	SO645	2352.5	113	1017	SO711	1362.5	113	1083	SHIELDING	-455.0	258
952	SO646	2337.5	243	1018	SO712	1347.5	243	1084	SO769	-507.5	243
953	SO647	2322.5	113	1019	SO713	1332.5	113	1085	SO770	-522.5	113
954	SO648	2307.5	243	1020	SO714	1317.5	243	1086	SO771	-537.5	243
955	SO649	2292.5	113	1021	SO715	1302.5	113	1087	SO772	-552.5	113
956	SO650	2277.5	243	1022	SO716	1287.5	243	1088	SO773	-567.5	243
957	SO651	2262.5	113	1023	SO717	1272.5	113	1089	SO774	-582.5	113
958	SO652	2247.5	243	1024	SO718	1257.5	243	1090	SO775	-597.5	243
959	SO653	2232.5	113	1025	SO719	1242.5	113	1091	SO776	-612.5	113
960	SO654	2217.5	243	1026	SO720	1227.5	243	1092	SO777	-627.5	243
961	SO655	2202.5	113	1027	SO721	1212.5	113	1093	SO778	-642.5	113
962	SO656	2187.5	243	1028	SO722	1197.5	243	1094	SO779	-657.5	243
963	SO657	2172.5	113	1029	SO723	1182.5	113	1095	SO780	-672.5	113
964	SO658	2157.5	243	1030	SO724	1167.5	243	1096	SO781	-687.5	243
965	SO659	2142.5	113	1031	SO725	1152.5	113	1097	SO782	-702.5	113
966	SO660	2127.5	243	1032	SO726	1137.5	243	1098	SO783	-717.5	243
967	SO661	2112.5	113	1033	SO727	1122.5	113	1099	SO784	-732.5	113
968	SO662	2097.5	243	1034	SO728	1107.5	243	1100	SO785	-747.5	243
969	SO663	2082.5	113	1035	SO729	1092.5	113	1101	SO786	-762.5	113
970	SO664	2067.5	243	1036	SO730	1077.5	243	1102	SO787	-777.5	243
971	SO665	2052.5	113	1037	SO731	1062.5	113	1103	SO788	-792.5	113
972	SO666	2037.5	243	1038	SO732	1047.5	243	1104	SO789	-807.5	243
973	SO667	2022.5	113	1039	SO733	1032.5	113	1105	SO790	-822.5	113
974	SO668	2007.5	243	1040	SO734	1017.5	243	1106	SO791	-837.5	243
975	SO669	1992.5	113	1041	SO735	1002.5	113	1107	SO792	-852.5	113
976	SO670	1977.5	243	1042	SO736	987.5	243	1108	SO793	-867.5	243
977	SO671	1962.5	113	1043	SO737	972.5	113	1109	SO794	-882.5	113
978	SO672	1947.5	243	1044	SO738	957.5	243	1110	SO795	-897.5	243
979	SO673	1932.5	113	1045	SO739	942.5	113	1111	SO796	-912.5	113
980	SO674	1917.5	243	1046	SO740	927.5	243	1112	SO797	-927.5	243
981	SO675	1902.5	113	1047	SO741	912.5	113	1113	SO798	-942.5	113
982	SO676	1887.5	243	1048	SO742	897.5	243	1114	SO799	-957.5	243
983	SO677	1872.5	113	1049	SO743	882.5	113	1115	SO800	-972.5	113

1116	SO801	-987.5	243	1182	SO867	-1977.5	243	1248	SO933	-2967.5	243
1117	SO802	-1002.5	113	1183	SO868	-1992.5	113	1249	SO934	-2982.5	113
1118	SO803	-1017.5	243	1184	SO869	-2007.5	243	1250	SO935	-2997.5	243
1119	SO804	-1032.5	113	1185	SO870	-2022.5	113	1251	SO936	-3012.5	113
1120	SO805	-1047.5	243	1186	SO871	-2037.5	243	1252	SO937	-3027.5	243
1121	SO806	-1062.5	113	1187	SO872	-2052.5	113	1253	SO938	-3042.5	113
1122	SO807	-1077.5	243	1188	SO873	-2067.5	243	1254	SO939	-3057.5	243
1123	SO808	-1092.5	113	1189	SO874	-2082.5	113	1255	SO940	-3072.5	113
1124	SO809	-1107.5	243	1190	SO875	-2097.5	243	1256	SO941	-3087.5	243
1125	SO810	-1122.5	113	1191	SO876	-2112.5	113	1257	SO942	-3102.5	113
1126	SO811	-1137.5	243	1192	SO877	-2127.5	243	1258	SO943	-3117.5	243
1127	SO812	-1152.5	113	1193	SO878	-2142.5	113	1259	SO944	-3132.5	113
1128	SO813	-1167.5	243	1194	SO879	-2157.5	243	1260	SO945	-3147.5	243
1129	SO814	-1182.5	113	1195	SO880	-2172.5	113	1261	SO946	-3162.5	113
1130	SO815	-1197.5	243	1196	SO881	-2187.5	243	1262	SO947	-3177.5	243
1131	SO816	-1212.5	113	1197	SO882	-2202.5	113	1263	SO948	-3192.5	113
1132	SO817	-1227.5	243	1198	SO883	-2217.5	243	1264	SO949	-3207.5	243
1133	SO818	-1242.5	113	1199	SO884	-2232.5	113	1265	SO950	-3222.5	113
1134	SO819	-1257.5	243	1200	SO885	-2247.5	243	1266	SO951	-3237.5	243
1135	SO820	-1272.5	113	1201	SO886	-2262.5	113	1267	SO952	-3252.5	113
1136	SO821	-1287.5	243	1202	SO887	-2277.5	243	1268	SO953	-3267.5	243
1137	SO822	-1302.5	113	1203	SO888	-2292.5	113	1269	SO954	-3282.5	113
1138	SO823	-1317.5	243	1204	SO889	-2307.5	243	1270	SO955	-3297.5	243
1139	SO824	-1332.5	113	1205	SO890	-2322.5	113	1271	SO956	-3312.5	113
1140	SO825	-1347.5	243	1206	SO891	-2337.5	243	1272	SO957	-3327.5	243
1141	SO826	-1362.5	113	1207	SO892	-2352.5	113	1273	SO958	-3342.5	113
1142	SO827	-1377.5	243	1208	SO893	-2367.5	243	1274	SO959	-3357.5	243
1143	SO828	-1392.5	113	1209	SO894	-2382.5	113	1275	SO960	-3372.5	113
1144	SO829	-1407.5	243	1210	SO895	-2397.5	243	1276	SO961	-3387.5	243
1145	SO830	-1422.5	113	1211	SO896	-2412.5	113	1277	SO962	-3402.5	113
1146	SO831	-1437.5	243	1212	SO897	-2427.5	243	1278	SO963	-3417.5	243
1147	SO832	-1452.5	113	1213	SO898	-2442.5	113	1279	SO964	-3432.5	113
1148	SO833	-1467.5	243	1214	SO899	-2457.5	243	1280	SO965	-3447.5	243
1149	SO834	-1482.5	113	1215	SO900	-2472.5	113	1281	SO966	-3462.5	113
1150	SO835	-1497.5	243	1216	SO901	-2487.5	243	1282	SO967	-3477.5	243
1151	SO836	-1512.5	113	1217	SO902	-2502.5	113	1283	SO968	-3492.5	113
1152	SO837	-1527.5	243	1218	SO903	-2517.5	243	1284	SO969	-3507.5	243
1153	SO838	-1542.5	113	1219	SO904	-2532.5	113	1285	SO970	-3522.5	113
1154	SO839	-1557.5	243	1220	SO905	-2547.5	243	1286	SO971	-3537.5	243
1155	SO840	-1572.5	113	1221	SO906	-2562.5	113	1287	SO972	-3552.5	113
1156	SO841	-1587.5	243	1222	SO907	-2577.5	243	1288	SO973	-3567.5	243
1157	SO842	-1602.5	113	1223	SO908	-2592.5	113	1289	SO974	-3582.5	113
1158	SO843	-1617.5	243	1224	SO909	-2607.5	243	1290	SO975	-3597.5	243
1159	SO844	-1632.5	113	1225	SO910	-2622.5	113	1291	SO976	-3612.5	113
1160	SO845	-1647.5	243	1226	SO911	-2637.5	243	1292	SO977	-3627.5	243
1161	SO846	-1662.5	113	1227	SO912	-2652.5	113	1293	SO978	-3642.5	113
1162	SO847	-1677.5	243	1228	SO913	-2667.5	243	1294	SO979	-3657.5	243
1163	SO848	-1692.5	113	1229	SO914	-2682.5	113	1295	SO980	-3672.5	113
1164	SO849	-1707.5	243	1230	SO915	-2697.5	243	1296	SO981	-3687.5	243
1165	SO850	-1722.5	113	1231	SO916	-2712.5	113	1297	SO982	-3702.5	113
1166	SO851	-1737.5	243	1232	SO917	-2727.5	243	1298	SO983	-3717.5	243
1167	SO852	-1752.5	113	1233	SO918	-2742.5	113	1299	SO984	-3732.5	113
1168	SO853	-1767.5	243	1234	SO919	-2757.5	243	1300	SO985	-3747.5	243
1169	SO854	-1782.5	113	1235	SO920	-2772.5	113	1301	SO986	-3762.5	113
1170	SO855	-1797.5	243	1236	SO921	-2787.5	243	1302	SO987	-3777.5	243
1171	SO856	-1812.5	113	1237	SO922	-2802.5	113	1303	SO988	-3792.5	113
1172	SO857	-1827.5	243	1238	SO923	-2817.5	243	1304	SO989	-3807.5	243
1173	SO858	-1842.5	113	1239	SO924	-2832.5	113	1305	SO990	-3822.5	113
1174	SO859	-1857.5	243	1240	SO925	-2847.5	243	1306	SO991	-3837.5	243
1175	SO860	-1872.5	113	1241	SO926	-2862.5	113	1307	SO992	-3852.5	113
1176	SO861	-1887.5	243	1242	SO927	-2877.5	243	1308	SO993	-3867.5	243
1177	SO862	-1902.5	113	1243	SO928	-2892.5	113	1309	SO994	-3882.5	113
1178	SO863	-1917.5	243	1244	SO929	-2907.5	243	1310	SO995	-3897.5	243
1179	SO864	-1932.5	113	1245	SO930	-2922.5	113	1311	SO996	-3912.5	113
1180	SO865	-1947.5	243	1246	SO931	-2937.5	243	1312	SO997	-3927.5	243
1181	SO866	-1962.5	113	1247	SO932	-2952.5	113	1313	SO998	-3942.5	113

1314	SO999	-3957.5	243
1315	SO1000	-3972.5	113
1316	SO1001	-3987.5	243
1317	SO1002	-4002.5	113
1318	SO1003	-4017.5	243
1319	SO1004	-4032.5	113
1320	SO1005	-4047.5	243
1321	SO1006	-4062.5	113
1322	SO1007	-4077.5	243
1323	SO1008	-4092.5	113
1324	SO1009	-4107.5	243
1325	SO1010	-4122.5	113
1326	SO1011	-4137.5	243
1327	SO1012	-4152.5	113
1328	SO1013	-4167.5	243
1329	SO1014	-4182.5	113
1330	SO1015	-4197.5	243
1331	SO1016	-4212.5	113
1332	SO1017	-4227.5	243
1333	SO1018	-4242.5	113
1334	SO1019	-4257.5	243
1335	SO1020	-4272.5	113
1336	SO1021	-4287.5	243
1337	SO1022	-4302.5	113
1338	SO1023	-4317.5	243
1339	SO1024	-4332.5	113
1340	SO1025	-4347.5	243
1341	SO1026	-4362.5	113
1342	SO1027	-4377.5	243
1343	SO1028	-4392.5	113
1344	SO1029	-4407.5	243
1345	SO1030	-4422.5	113
1346	SO1031	-4437.5	243
1347	SO1032	-4452.5	113
1348	SO1033	-4467.5	243
1349	SO1034	-4482.5	113
1350	SO1035	-4497.5	243
1351	SO1036	-4512.5	113
1352	SO1037	-4527.5	243
1353	SO1038	-4542.5	113
1354	SO1039	-4557.5	243
1355	SO1040	-4572.5	113
1356	SO1041	-4587.5	243
1357	SO1042	-4602.5	113
1358	SO1043	-4617.5	243
1359	SO1044	-4632.5	113
1360	SO1045	-4647.5	243
1361	SO1046	-4662.5	113
1362	SO1047	-4677.5	243
1363	SO1048	-4692.5	113
1364	SO1049	-4707.5	243
1365	SO1050	-4722.5	113
1366	SO1051	-4737.5	243
1367	SO1052	-4752.5	113
1368	SO1053	-4767.5	243
1369	SO1054	-4782.5	113
1370	SO1055	-4797.5	243
1371	SO1056	-4812.5	113
1372	SO1057	-4827.5	243
1373	SO1058	-4842.5	113
1374	SO1059	-4857.5	243
1375	SO1060	-4872.5	113
1376	SO1061	-4887.5	243
1377	SO1062	-4902.5	113
1378	SO1063	-4917.5	243
1379	SO1064	-4932.5	113

1380	SO1065	-4947.5	243
1381	SO1066	-4962.5	113
1382	SO1067	-4977.5	243
1383	SO1068	-4992.5	113
1384	SO1069	-5007.5	243
1385	SO1070	-5022.5	113
1386	SO1071	-5037.5	243
1387	SO1072	-5052.5	113
1388	SO1073	-5067.5	243
1389	SO1074	-5082.5	113
1390	SO1075	-5097.5	243
1391	SO1076	-5112.5	113
1392	SO1077	-5127.5	243
1393	SO1078	-5142.5	113
1394	SO1079	-5157.5	243
1395	SO1080	-5172.5	113
1396	SO1081	-5187.5	243
1397	SO1082	-5202.5	113
1398	SO1083	-5217.5	243
1399	SO1084	-5232.5	113
1400	SO1085	-5247.5	243
1401	SO1086	-5262.5	113
1402	SO1087	-5277.5	243
1403	SO1088	-5292.5	113
1404	SO1089	-5307.5	243
1405	SO1090	-5322.5	113
1406	SO1091	-5337.5	243
1407	SO1092	-5352.5	113
1408	SO1093	-5367.5	243
1409	SO1094	-5382.5	113
1410	SO1095	-5397.5	243
1411	SO1096	-5412.5	113
1412	SO1097	-5427.5	243
1413	SO1098	-5442.5	113
1414	SO1099	-5457.5	243
1415	SO1100	-5472.5	113
1416	SO1101	-5487.5	243
1417	SO1102	-5502.5	113
1418	SO1103	-5517.5	243
1419	SO1104	-5532.5	113
1420	SO1105	-5547.5	243
1421	SO1106	-5562.5	113
1422	SO1107	-5577.5	243
1423	SO1108	-5592.5	113
1424	SO1109	-5607.5	243
1425	SO1110	-5622.5	113
1426	SO1111	-5637.5	243
1427	SO1112	-5652.5	113
1428	SO1113	-5667.5	243
1429	SO1114	-5682.5	113
1430	SO1115	-5697.5	243
1431	SO1116	-5712.5	113
1432	SO1117	-5727.5	243
1433	SO1118	-5742.5	113
1434	SO1119	-5757.5	243
1435	SO1120	-5772.5	113
1436	SO1121	-5787.5	243
1437	SO1122	-5802.5	113
1438	SO1123	-5817.5	243
1439	SO1124	-5832.5	113
1440	SO1125	-5847.5	243
1441	SO1126	-5862.5	113
1442	SO1127	-5877.5	243
1443	SO1128	-5892.5	113
1444	SO1129	-5907.5	243
1445	SO1130	-5922.5	113

1446	SO1131	-5937.5	243
1447	SO1132	-5952.5	113
1448	SO1133	-5967.5	243
1449	SO1134	-5982.5	113
1450	SO1135	-5997.5	243
1451	SO1136	-6012.5	113
1452	SO1137	-6027.5	243
1453	SO1138	-6042.5	113
1454	SO1139	-6057.5	243
1455	SO1140	-6072.5	113
1456	SO1141	-6087.5	243
1457	SO1142	-6102.5	113
1458	SO1143	-6117.5	243
1459	SO1144	-6132.5	113
1460	SO1145	-6147.5	243
1461	SO1146	-6162.5	113
1462	SO1147	-6177.5	243
1463	SO1148	-6192.5	113
1464	SO1149	-6207.5	243
1465	SO1150	-6222.5	113
1466	SO1151	-6237.5	243
1467	SO1152	-6252.5	113
1468	SO1153	-6267.5	243
1469	SO1154	-6282.5	113
1470	SO1155	-6297.5	243
1471	SO1156	-6312.5	113
1472	SO1157	-6327.5	243
1473	SO1158	-6342.5	113
1474	SO1159	-6357.5	243
1475	SO1160	-6372.5	113
1476	SO1161	-6387.5	243
1477	SO1162	-6402.5	113
1478	SO1163	-6417.5	243
1479	SO1164	-6432.5	113
1480	SO1165	-6447.5	243
1481	SO1166	-6462.5	113
1482	SO1167	-6477.5	243
1483	SO1168	-6492.5	113
1484	SO1169	-6507.5	243
1485	SO1170	-6522.5	113
1486	SO1171	-6537.5	243
1487	SO1172	-6552.5	113
1488	SO1173	-6567.5	243
1489	SO1174	-6582.5	113
1490	SO1175	-6597.5	243
1491	SO1176	-6612.5	113
1492	SO1177	-6627.5	243
1493	SO1178	-6642.5	113
1494	SO1179	-6657.5	243
1495	SO1180	-6672.5	113
1496	SO1181	-6687.5	243
1497	SO1182	-6702.5	113
1498	SO1183	-6717.5	243
1499	SO1184	-6732.5	113
1500	SO1185	-6747.5	243
1501	SO1186	-6762.5	113
1502	SO1187	-6777.5	243
1503	SO1188	-6792.5	113
1504	SO1189	-6807.5	243
1505	SO1190	-6822.5	113
1506	SO1191	-6837.5	243
1507	SO1192	-6852.5	113
1508	SO1193	-6867.5	243
1509	SO1194	-6882.5	113
1510	SO1195	-6897.5	243
1511	SO1196	-6912.5	113

1512	SO1197	-6927.5	243	1578	SO1263	-7917.5	243	1644	SO1329	-8907.5	243
1513	SO1198	-6942.5	113	1579	SO1264	-7932.5	113	1645	SO1330	-8922.5	113
1514	SO1199	-6957.5	243	1580	SO1265	-7947.5	243	1646	SO1331	-8937.5	243
1515	SO1200	-6972.5	113	1581	SO1266	-7962.5	113	1647	SO1332	-8952.5	113
1516	SO1201	-6987.5	243	1582	SO1267	-7977.5	243	1648	SO1333	-8967.5	243
1517	SO1202	-7002.5	113	1583	SO1268	-7992.5	113	1649	SO1334	-8982.5	113
1518	SO1203	-7017.5	243	1584	SO1269	-8007.5	243	1650	SO1335	-8997.5	243
1519	SO1204	-7032.5	113	1585	SO1270	-8022.5	113	1651	SO1336	-9012.5	113
1520	SO1205	-7047.5	243	1586	SO1271	-8037.5	243	1652	SO1337	-9027.5	243
1521	SO1206	-7062.5	113	1587	SO1272	-8052.5	113	1653	SO1338	-9042.5	113
1522	SO1207	-7077.5	243	1588	SO1273	-8067.5	243	1654	SO1339	-9057.5	243
1523	SO1208	-7092.5	113	1589	SO1274	-8082.5	113	1655	SO1340	-9072.5	113
1524	SO1209	-7107.5	243	1590	SO1275	-8097.5	243	1656	SO1341	-9087.5	243
1525	SO1210	-7122.5	113	1591	SO1276	-8112.5	113	1657	SO1342	-9102.5	113
1526	SO1211	-7137.5	243	1592	SO1277	-8127.5	243	1658	SO1343	-9117.5	243
1527	SO1212	-7152.5	113	1593	SO1278	-8142.5	113	1659	SO1344	-9132.5	113
1528	SO1213	-7167.5	243	1594	SO1279	-8157.5	243	1660	SO1345	-9147.5	243
1529	SO1214	-7182.5	113	1595	SO1280	-8172.5	113	1661	SO1346	-9162.5	113
1530	SO1215	-7197.5	243	1596	SO1281	-8187.5	243	1662	SO1347	-9177.5	243
1531	SO1216	-7212.5	113	1597	SO1282	-8202.5	113	1663	SO1348	-9192.5	113
1532	SO1217	-7227.5	243	1598	SO1283	-8217.5	243	1664	SO1349	-9207.5	243
1533	SO1218	-7242.5	113	1599	SO1284	-8232.5	113	1665	SO1350	-9222.5	113
1534	SO1219	-7257.5	243	1600	SO1285	-8247.5	243	1666	SO1351	-9237.5	243
1535	SO1220	-7272.5	113	1601	SO1286	-8262.5	113	1667	SO1352	-9252.5	113
1536	SO1221	-7287.5	243	1602	SO1287	-8277.5	243	1668	SO1353	-9267.5	243
1537	SO1222	-7302.5	113	1603	SO1288	-8292.5	113	1669	SO1354	-9282.5	113
1538	SO1223	-7317.5	243	1604	SO1289	-8307.5	243	1670	SO1355	-9297.5	243
1539	SO1224	-7332.5	113	1605	SO1290	-8322.5	113	1671	SO1356	-9312.5	113
1540	SO1225	-7347.5	243	1606	SO1291	-8337.5	243	1672	SO1357	-9327.5	243
1541	SO1226	-7362.5	113	1607	SO1292	-8352.5	113	1673	SO1358	-9342.5	113
1542	SO1227	-7377.5	243	1608	SO1293	-8367.5	243	1674	SO1359	-9357.5	243
1543	SO1228	-7392.5	113	1609	SO1294	-8382.5	113	1675	SO1360	-9372.5	113
1544	SO1229	-7407.5	243	1610	SO1295	-8397.5	243	1676	SO1361	-9387.5	243
1545	SO1230	-7422.5	113	1611	SO1296	-8412.5	113	1677	SO1362	-9402.5	113
1546	SO1231	-7437.5	243	1612	SO1297	-8427.5	243	1678	SO1363	-9417.5	243
1547	SO1232	-7452.5	113	1613	SO1298	-8442.5	113	1679	SO1364	-9432.5	113
1548	SO1233	-7467.5	243	1614	SO1299	-8457.5	243	1680	SO1365	-9447.5	243
1549	SO1234	-7482.5	113	1615	SO1300	-8472.5	113	1681	SO1366	-9462.5	113
1550	SO1235	-7497.5	243	1616	SO1301	-8487.5	243	1682	SO1367	-9477.5	243
1551	SO1236	-7512.5	113	1617	SO1302	-8502.5	113	1683	SO1368	-9492.5	113
1552	SO1237	-7527.5	243	1618	SO1303	-8517.5	243	1684	SO1369	-9507.5	243
1553	SO1238	-7542.5	113	1619	SO1304	-8532.5	113	1685	SO1370	-9522.5	113
1554	SO1239	-7557.5	243	1620	SO1305	-8547.5	243	1686	SO1371	-9537.5	243
1555	SO1240	-7572.5	113	1621	SO1306	-8562.5	113	1687	SO1372	-9552.5	113
1556	SO1241	-7587.5	243	1622	SO1307	-8577.5	243	1688	SO1373	-9567.5	243
1557	SO1242	-7602.5	113	1623	SO1308	-8592.5	113	1689	SO1374	-9582.5	113
1558	SO1243	-7617.5	243	1624	SO1309	-8607.5	243	1690	SO1375	-9597.5	243
1559	SO1244	-7632.5	113	1625	SO1310	-8622.5	113	1691	SO1376	-9612.5	113
1560	SO1245	-7647.5	243	1626	SO1311	-8637.5	243	1692	SO1377	-9627.5	243
1561	SO1246	-7662.5	113	1627	SO1312	-8652.5	113	1693	SO1378	-9642.5	113
1562	SO1247	-7677.5	243	1628	SO1313	-8667.5	243	1694	SO1379	-9657.5	243
1563	SO1248	-7692.5	113	1629	SO1314	-8682.5	113	1695	SO1380	-9672.5	113
1564	SO1249	-7707.5	243	1630	SO1315	-8697.5	243	1696	SO1381	-9687.5	243
1565	SO1250	-7722.5	113	1631	SO1316	-8712.5	113	1697	SO1382	-9702.5	113
1566	SO1251	-7737.5	243	1632	SO1317	-8727.5	243	1698	SO1383	-9717.5	243
1567	SO1252	-7752.5	113	1633	SO1318	-8742.5	113	1699	SO1384	-9732.5	113
1568	SO1253	-7767.5	243	1634	SO1319	-8757.5	243	1700	SO1385	-9747.5	243
1569	SO1254	-7782.5	113	1635	SO1320	-8772.5	113	1701	SO1386	-9762.5	113
1570	SO1255	-7797.5	243	1636	SO1321	-8787.5	243	1702	SO1387	-9777.5	243
1571	SO1256	-7812.5	113	1637	SO1322	-8802.5	113	1703	SO1388	-9792.5	113
1572	SO1257	-7827.5	243	1638	SO1323	-8817.5	243	1704	SO1389	-9807.5	243
1573	SO1258	-7842.5	113	1639	SO1324	-8832.5	113	1705	SO1390	-9822.5	113
1574	SO1259	-7857.5	243	1640	SO1325	-8847.5	243	1706	SO1391	-9837.5	243
1575	SO1260	-7872.5	113	1641	SO1326	-8862.5	113	1707	SO1392	-9852.5	113
1576	SO1261	-7887.5	243	1642	SO1327	-8877.5	243	1708	SO1393	-9867.5	243
1577	SO1262	-7902.5	113	1643	SO1328	-8892.5	113	1709	SO1394	-9882.5	113

1710	SO1395	-9897.5	243		1765	SO1450	-10722.5	113		1820	SO1505	-11547.5	243
1711	SO1396	-9912.5	113		1766	SO1451	-10737.5	243		1821	SO1506	-11562.5	113
1712	SO1397	-9927.5	243		1767	SO1452	-10752.5	113		1822	SO1507	-11577.5	243
1713	SO1398	-9942.5	113		1768	SO1453	-10767.5	243		1823	SO1508	-11592.5	113
1714	SO1399	-9957.5	243		1769	SO1454	-10782.5	113		1824	SO1509	-11607.5	243
1715	SO1400	-9972.5	113		1770	SO1455	-10797.5	243		1825	SO1510	-11622.5	113
1716	SO1401	-9987.5	243		1771	SO1456	-10812.5	113		1826	SO1511	-11637.5	243
1717	SO1402	-10002.5	113		1772	SO1457	-10827.5	243		1827	SO1512	-11652.5	113
1718	SO1403	-10017.5	243		1773	SO1458	-10842.5	113		1828	SO1513	-11667.5	243
1719	SO1404	-10032.5	113		1774	SO1459	-10857.5	243		1829	SO1514	-11682.5	113
1720	SO1405	-10047.5	243		1775	SO1460	-10872.5	113		1830	SO1515	-11697.5	243
1721	SO1406	-10062.5	113		1776	SO1461	-10887.5	243		1831	SO1516	-11712.5	113
1722	SO1407	-10077.5	243		1777	SO1462	-10902.5	113		1832	SO1517	-11727.5	243
1723	SO1408	-10092.5	113		1778	SO1463	-10917.5	243		1833	SO1518	-11742.5	113
1724	SO1409	-10107.5	243		1779	SO1464	-10932.5	113		1834	SO1519	-11757.5	243
1725	SO1410	-10122.5	113		1780	SO1465	-10947.5	243		1835	SO1520	-11772.5	113
1726	SO1411	-10137.5	243		1781	SO1466	-10962.5	113		1836	SO1521	-11787.5	243
1727	SO1412	-10152.5	113		1782	SO1467	-10977.5	243		1837	SO1522	-11802.5	113
1728	SO1413	-10167.5	243		1783	SO1468	-10992.5	113		1838	SO1523	-11817.5	243
1729	SO1414	-10182.5	113		1784	SO1469	-11007.5	243		1839	SO1524	-11832.5	113
1730	SO1415	-10197.5	243		1785	SO1470	-11022.5	113		1840	SO1525	-11847.5	243
1731	SO1416	-10212.5	113		1786	SO1471	-11037.5	243		1841	SO1526	-11862.5	113
1732	SO1417	-10227.5	243		1787	SO1472	-11052.5	113		1842	SO1527	-11877.5	243
1733	SO1418	-10242.5	113		1788	SO1473	-11067.5	243		1843	SO1528	-11892.5	113
1734	SO1419	-10257.5	243		1789	SO1474	-11082.5	113		1844	SO1529	-11907.5	243
1735	SO1420	-10272.5	113		1790	SO1475	-11097.5	243		1845	SO1530	-11922.5	113
1736	SO1421	-10287.5	243		1791	SO1476	-11112.5	113		1846	SO1531	-11937.5	243
1737	SO1422	-10302.5	113		1792	SO1477	-11127.5	243		1847	SO1532	-11952.5	113
1738	SO1423	-10317.5	243		1793	SO1478	-11142.5	113		1848	SO1533	-11967.5	243
1739	SO1424	-10332.5	113		1794	SO1479	-11157.5	243		1849	SO1534	-11982.5	113
1740	SO1425	-10347.5	243		1795	SO1480	-11172.5	113		1850	SO1535	-11997.5	243
1741	SO1426	-10362.5	113		1796	SO1481	-11187.5	243		1851	SO1536	-12012.5	113
1742	SO1427	-10377.5	243		1797	SO1482	-11202.5	113		1852	SHIELDING	-12055.0	258
1743	SO1428	-10392.5	113		1798	SO1483	-11217.5	243		1853	COM1_OUT	-12105.0	258
1744	SO1429	-10407.5	243		1799	SO1484	-11232.5	113		1854	COM1_OUT	-12155.0	258
1745	SO1430	-10422.5	113		1800	SO1485	-11247.5	243		1855	SHIELDING	-12205.0	258
1746	SO1431	-10437.5	243		1801	SO1486	-11262.5	113		1856	F_CtrlR	-12403.0	278
1747	SO1432	-10452.5	113		1802	SO1487	-11277.5	243		1857	OEVR	-12303.0	238
1748	SO1433	-10467.5	243		1803	SO1488	-11292.5	113		1858	SYNC1R	-12403.0	198
1749	SO1434	-10482.5	113		1804	SO1489	-11307.5	243		1859	SYNC2R	-12303.0	158
1750	SO1435	-10497.5	243		1805	SO1490	-11322.5	113		1860	UDR	-12403.0	118
1751	SO1436	-10512.5	113		1806	SO1491	-11337.5	243		1861	CKVR	-12303.0	78
1752	SO1437	-10527.5	243		1807	SO1492	-11352.5	113		1862	STV2R	-12403.0	38
1753	SO1438	-10542.5	113		1808	SO1493	-11367.5	243		1863	STV1R	-12303.0	-2
1754	SO1439	-10557.5	243		1809	SO1494	-11382.5	113		1864	F_CtrlR	-12403.0	-42
1755	SO1440	-10572.5	113		1810	SO1495	-11397.5	243		1865	STBNR	-12303.0	-82
1756	SO1441	-10587.5	243		1811	SO1496	-11412.5	113			ALIGNMENT_M	-12131.5	115.5
1757	SO1442	-10602.5	113		1812	SO1497	-11427.5	243			ARK_L		
1758	SO1443	-10617.5	243		1813	SO1498	-11442.5	113			ALIGNMENT_M	12131.5	115.5
1759	SO1444	-10632.5	113		1814	SO1499	-11457.5	243			ARK_R		
1760	SO1445	-10647.5	243		1815	SO1500	-11472.5	113					
1761	SO1446	-10662.5	113		1816	SO1501	-11487.5	243					
1762	SO1447	-10677.5	243		1817	SO1502	-11502.5	113					
1763	SO1448	-10692.5	113		1818	SO1503	-11517.5	243					
1764	SO1449	-10707.5	243		1819	SO1504	-11532.5	113					

10. DEFINITIONS**10.1. Data Sheet Status**

Preliminary Data Sheet	This data sheet contains preliminary data; supplementary data may be published later.
Data Sheet	This data sheet contains final product specifications.

Contents in the document are subject to change without notice.

10.2. Life Support Application

These products are not designed for use in life support appliances, devices, or systems where malfunction of these products can reasonably be expected to result in personal injury. fitipower customers using or selling these products for use in such applications do so at their own risk and agree to fully indemnify fitipower for any damages resulting from such improper use or sale.

FITIPOWER CONFIDENTIAL
NO DISCLOSURE