

EL1511

Medium Power Differential Line Driver

FN7016  
Rev 2.00  
April 10, 2007

The EL1511 is a dual operational amplifier designed for customer premise line driving in DMT ADSL solutions. This device features a high drive capability of 360mA while consuming only 7.5mA of supply current per amplifier and operating from a single 5V to 15V supply. This driver achieves a typical distortion of less than -85dBc, at 150kHz into a 25Ω load. The EL1511 is available in the thermally-enhanced 16 Ld SOIC (0.150") and a 16 Ld QFN (4x4mm) packages. The EL1511 is specified for operation over the full -40°C to +85°C temperature range. Electrical characteristics are given for typical 15V supply operation.

The EL1511 has two control pins, C<sub>0</sub> and C<sub>1</sub>, which allow the selection of full I<sub>S</sub> power, 3/4-I<sub>S</sub>, 1/2-I<sub>S</sub>, and power-down modes.

The EL1511 is ideal for ADSL, SDSL, and HDSL2 line driving applications for single power supply, high voltage swing, and low power.

The EL1511 maintains excellent distortion and load driving capabilities even in the lowest power settings.

**Features**

- Drives up to 360mA from a +15V supply
- 24V<sub>P-P</sub> differential output drive into 25Ω and 26V<sub>P-P</sub> differential output drive into 100Ω
- -85dBc typical driver output distortion at full output at 150kHz
- Low quiescent current of 3.5mA per amplifier at 1/2-I<sub>S</sub> current mode
- Disable down to 1.5mA
- Pb-free plus anneal available (RoHS compliant)

**Applications**

- ADSL CSA line driving
- ADSL full rate CPE line driving
- G.SHDSL, HDSL2 line driver
- Video distribution amplifier
- Video twisted-pair line driver

**Pinouts**

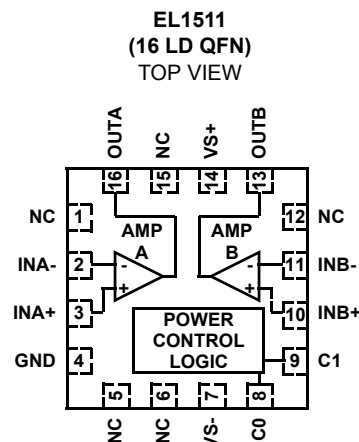
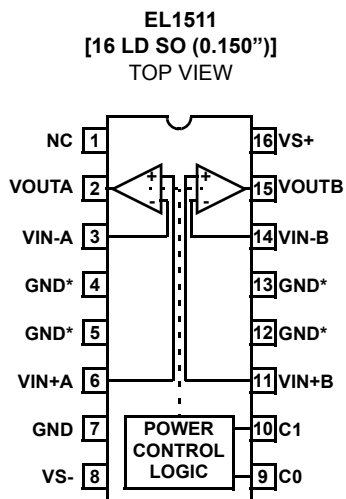

NOTE: \* These GND pins are heat spreaders

## Ordering Information

| PART NUMBER                 | PART MARKING | TAPE & REEL | PACKAGE                        | PKG. DWG. # |
|-----------------------------|--------------|-------------|--------------------------------|-------------|
| EL1511CS                    | EL1511CS     | -           | 16 Ld SO (0.150")              | MDP0027     |
| EL1511CS-T7                 | EL1511CS     | 7"          | 16 Ld SO (0.150")              | MDP0027     |
| EL1511CS-T13                | EL1511CS     | 13"         | 16 Ld SO (0.150")              | MDP0027     |
| EL1511CSZ<br>(See Note)     | EL1511CSZ    | -           | 16 Ld SO (0.150")<br>(Pb-Free) | MDP0027     |
| EL1511CSZ-T7<br>(See Note)  | EL1511CSZ    | 7"          | 16 Ld SO (0.150")<br>(Pb-Free) | MDP0027     |
| EL1511CSZ-T13<br>(See Note) | EL1511CSZ    | 13"         | 16 Ld SO (0.150")<br>(Pb-Free) | MDP0027     |
| EL1511CL                    | 1511CL       | -           | 16 Ld QFN                      | MDP0046     |
| EL1511CL-T7                 | 1511CL       | 7"          | 16 Ld QFN                      | MDP0046     |
| EL1511CL-T13                | 1511CL       | 13"         | 16 Ld QFN                      | MDP0046     |
| EL1511CLZ<br>(See Note)     | 1511CLZ      | -           | 16 Ld QFN<br>(Pb-Free)         | MDP0046     |
| EL1511CLZ-T7<br>(See Note)  | 1511CLZ      | 7"          | 16 Ld QFN<br>(Pb-Free)         | MDP0046     |
| EL1511CLZ-T13<br>(See Note) | 1511CLZ      | 13"         | 16 Ld QFN<br>(Pb-Free)         | MDP0046     |

NOTE: Intersil Pb-free plus anneal products employ special Pb-free material sets; molding compounds/die attach materials and 100% matte tin plate termination finish, which are RoHS compliant and compatible with both SnPb and Pb-free soldering operations. Intersil Pb-free products are MSL classified at Pb-free peak reflow temperatures that meet or exceed the Pb-free requirements of IPC/JEDEC J STD-020.

**Absolute Maximum Ratings** (T<sub>A</sub> = +25°C)

|   |                                    |                                |                 |
|---|------------------------------------|--------------------------------|-----------------|
| V <sub>S+</sub> to V <sub>S-</sub> Supply Voltage | 16.5V                              | Current into any Input         | 8mA             |
| V <sub>S+</sub> Voltage to Ground                 | -0.3V to +16.5V                    | Continuous Output Current      | 75mA            |
| V <sub>S-</sub> Voltage to Ground                 | -16.5V to 0.3V                     | Operating Temperature Range    | -40°C to +85°C  |
| Input C <sub>0</sub> /C <sub>1</sub> to Ground    | .7V                                | Storage Temperature Range      | -60°C to +150°C |
| V <sub>IN+</sub> Voltage                          | V <sub>S-</sub> to V <sub>S+</sub> | Operating Junction Temperature | -40°C to +150°C |
|   |                                    | Power Dissipation              | See Curves      |

CAUTION: Stresses above those listed in "Absolute Maximum Ratings" may cause permanent damage to the device. This is a stress only rating and operation of the device at these or any other conditions above those indicated in the operational sections of this specification is not implied.

IMPORTANT NOTE: All parameters having Min/Max specifications are guaranteed. Typical values are for information purposes only. Unless otherwise noted, all tests are at the specified temperature and are pulsed tests, therefore: T<sub>J</sub> = T<sub>C</sub> = T<sub>A</sub>

**Electrical Specifications** V<sub>S</sub> = ±7.5V, R<sub>F</sub> = 1.5kΩ, R<sub>L</sub> = 100Ω to mid supply, T<sub>A</sub> = +25°C unless otherwise specified.

| PARAMETER                     | DESCRIPTION  | CONDITIONS   | MIN  | TYP  | MAX   | UNIT   |
|-------------------------------|--|--|------|------|-------|--------|
| <b>AC PERFORMANCE</b>         |  |  |      |      |       |        |
| BW                            | -3dB Bandwidth   | A <sub>V</sub> = +4  |      | 70   |       | MHz    |
| HD                            | Total Harmonic Distortion                              | f = 150kHz, V <sub>O</sub> = 16V <sub>P-P</sub> , R <sub>L</sub> = 25Ω |      | -85  |       | dBc    |
| dG                            | Differential Gain                                      | A <sub>V</sub> = +2, R <sub>L</sub> = 37.5Ω                            |      | 0.15 |       | %      |
| dθ                            | Differential Phase                                     | A <sub>V</sub> = +2, R <sub>L</sub> = 37.5Ω                            |      | 0.1  |       | °      |
| SR                            | Slewrate   | V <sub>OUT</sub> from -3V to +3V                                       |      | 500  |       | V/μs   |
| <b>DC PERFORMANCE</b>         |  |  |      |      |       |        |
| V <sub>OS</sub>               | Offset Voltage   |  | -20  |      | 20    | mV     |
| ΔV <sub>OS</sub>              | V <sub>OS</sub> Mismatch                               |  | -10  |      | 10    | mV     |
| R <sub>OL</sub>               | Transimpedance   | V <sub>OUT</sub> from -4.5V to +4.5V                                   | 0.7  | 1.4  | 2.5   | MΩ     |
| <b>INPUT CHARACTERISTICS</b>  |  |  |      |      |       |        |
| I <sub>B+</sub>               | Non-Inverting Input Bias Current                       |  | -5   |      | 5     | μA     |
| I <sub>B-</sub>               | Inverting Input Bias Current                           |  | -30  |      | 30    | μA     |
| ΔI <sub>B-</sub>              | I <sub>B-</sub> Mismatch                               |  | -30  |      | 30    | μA     |
| e <sub>N</sub>                | Input Noise Voltage                                    |  |      | 2.8  |       | nV/√Hz |
| i <sub>N</sub>                | -Input Noise Current                                   |  |      | 19   |       | pA/√Hz |
| V <sub>IH</sub>               | Input High Voltage                                     | C <sub>0</sub> and C <sub>1</sub> inputs                               | 2.3  |      |       | V      |
| V <sub>IL</sub>               | Input Low Voltage                                      | C <sub>0</sub> and C <sub>1</sub> inputs                               |      |      | 1.5   | V      |
| I <sub>IH1</sub>              | Input High Current for C <sub>1</sub>                  | C <sub>1</sub> = 5V  | 0.2  |      | 8     | μA     |
| I <sub>IH0</sub>              | Input High Current for C <sub>0</sub>                  | C <sub>0</sub> = 5V  | 0.1  |      | 4     | μA     |
| I <sub>IL</sub>               | Input Low Current for C <sub>1</sub> or C <sub>0</sub> | C <sub>1</sub> = 0V, C <sub>0</sub> = 0V                               | -1   |      | 1     | μA     |
| <b>OUTPUT CHARACTERISTICS</b> |  |  |      |      |       |        |
| V <sub>OUT</sub>              | Loaded Output Swing (single ended)                     | V <sub>S</sub> = ±7.5, R <sub>L</sub> = 100Ω to GND                    | ±6.3 | ±6.5 |       | V      |
|                               |  | V <sub>S</sub> = ±7.5, R <sub>L</sub> = 25Ω to GND                     | ±5.7 | ±6.0 |       | V      |
| I <sub>OUT</sub>              | Output Current   | R <sub>L</sub> = 0Ω  |      | 450  |       | mA     |
| <b>SUPPLY</b>                 |  |  |      |      |       |        |
| V <sub>S</sub>                | Supply Voltage   | Single supply  | 5    |      | 15    | V      |
| I <sub>S+</sub> (Full Power)  | Positive Supply Current per Amplifier                  | All outputs at 0V, C <sub>0</sub> = C <sub>1</sub> = 0V                |      | 7    | 9.25  | mA     |
| I <sub>S-</sub> (Full Power)  | Negative Supply Current per Amplifier                  | All outputs at 0V, C <sub>0</sub> = C <sub>1</sub> = 0V                |      | -6.4 | -8.75 | mA     |
| I <sub>S+</sub> (3/4 Power)   | Positive Supply Current per Amplifier                  | All outputs at 0V, C <sub>0</sub> = 5V, C <sub>1</sub> = 0V            |      | 5.3  | 7.25  | mA     |

**Electrical Specifications**  $V_S = \pm 7.5V$ ,  $R_F = 1.5k\Omega$ ,  $R_L = 100\Omega$  to mid supply,  $T_A = +25^\circ C$  unless otherwise specified. (Continued)

| PARAMETER             | DESCRIPTION                           | CONDITIONS                                 | MIN | TYP  | MAX    | UNIT |
|-----------------------|---------------------------------------|--|-----|------|--------|------|
| $I_{S-}$ (3/4 Power)  | Negative Supply Current per Amplifier | All outputs at 0V, $C_0 = 5V$ , $C_1 = 0V$ |     | -4.7 | -6.75  | mA   |
| $I_{S+}$ (1/2 Power)  | Positive Supply Current per Amplifier | All outputs at 0V, $C_0 = 0V$ , $C_1 = 5V$ |     | 3.3  | 5.75   | mA   |
| $I_{S-}$ (1/2 Power)  | Negative Supply Current per Amplifier | All outputs at 0V, $C_0 = 0V$ , $C_1 = 5V$ |     | -2.7 | -5.2   | mA   |
| $I_{S+}$ (Power Down) | Positive Supply Current per Amplifier | All outputs at 0V, $C_0 = C_1 = 5V$        |     | 0.6  | 1.025  | mA   |
| $I_{S-}$ (Power Down) | Negative Supply Current per Amplifier | All outputs at 0V, $C_0 = C_1 = 5V$        |     | 0    | -0.525 | mA   |
| $I_{GND}$             | GND Supply Current per Amplifier      | All outputs at 0V                          |     | 0.6  | 1      | mA   |

**Pin Descriptions**

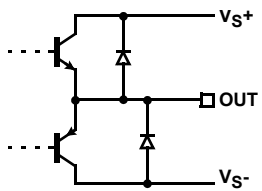
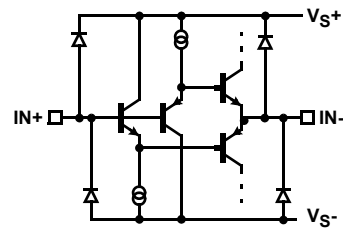
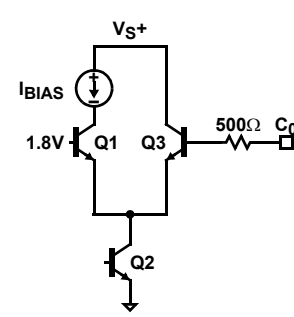
| EL1511CS<br>16 Ld SO<br>(0.150") | EL1511CL<br>16 Ld QFN | PIN NAME | PIN FUNCTION        | EQUIVALENT CIRCUIT   |
|----------------------------------|-----------------------|----------|---------------------|--|
| 1                                | 1, 5, 6, 12, 15       | NC       | Not Connected       |  |
| 2, 15                            | 13, 16                | OUT      | Output              |  <p>CIRCUIT 1</p>   |
| 3, 14                            | 2, 11                 | VIN-     | Inverting Input     |  <p>CIRCUIT 2</p>  |
| 4, 5, 7, 12, 13                  | 4                     | GND      | Ground Pins         |  |
| 6, 11                            | 3, 10                 | VIN+     | Non-inverting Input | Reference Circuit 2  |
| 8                                | 7                     | VS-      | Negative Supply     |  |
| 9                                | 8                     | C0       | Power Control       |  <p>CIRCUIT 3</p> |
| 10                               | 9                     | C1       | Power Control       | Reference Circuit 3  |

Typical Performance Curves

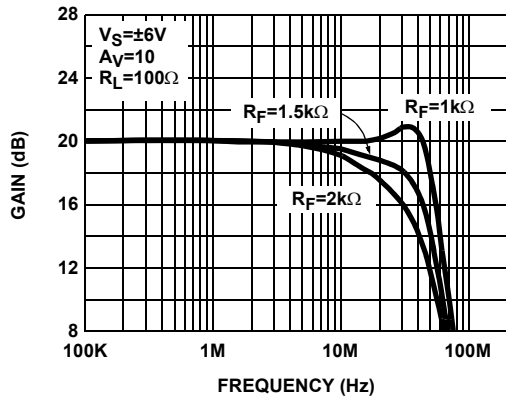

FIGURE 1. DIFFERENTIAL FREQUENCY RESPONSE (FULL POWER MODE)

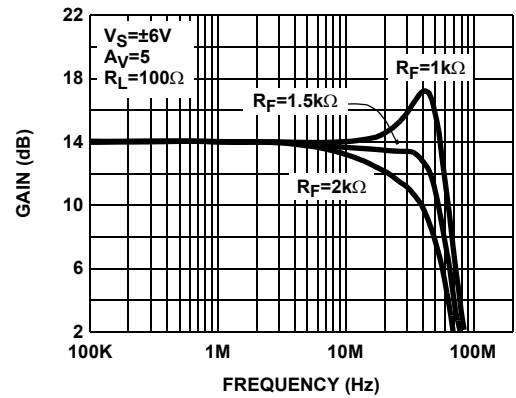

FIGURE 2. DIFFERENTIAL FREQUENCY RESPONSE (FULL POWER MODE)

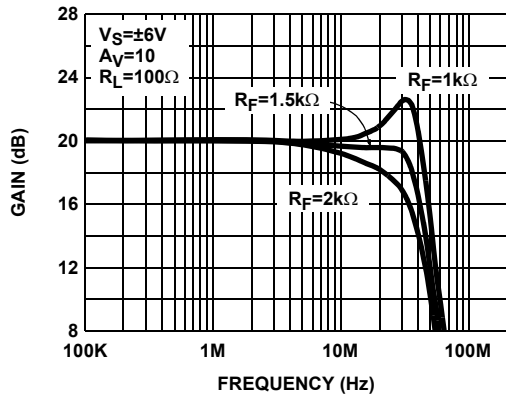

FIGURE 3. DIFFERENTIAL FREQUENCY RESPONSE (3/4 POWER MODE)

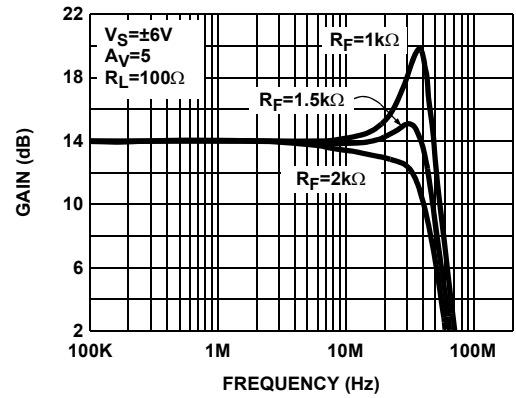

FIGURE 4. DIFFERENTIAL FREQUENCY RESPONSE (3/4 POWER MODE)

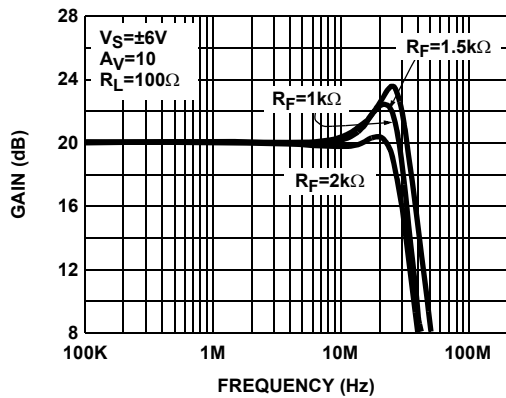

FIGURE 5. DIFFERENTIAL FREQUENCY RESPONSE (1/2 POWER MODE)

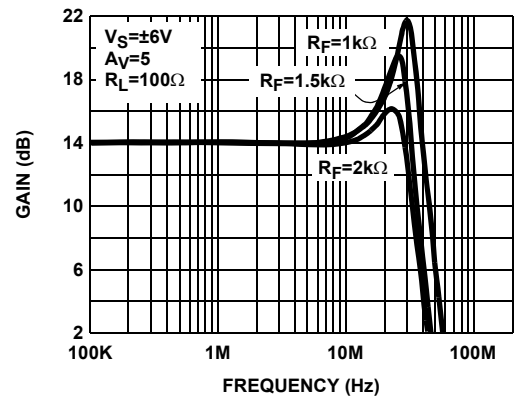

FIGURE 6. DIFFERENTIAL FREQUENCY RESPONSE (1/2 POWER MODE)

**Typical Performance Curves** (Continued)

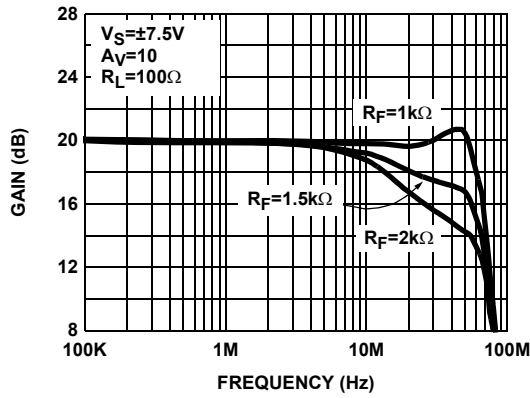

FIGURE 7. DIFFERENTIAL FREQUENCY RESPONSE (FULL POWER MODE)

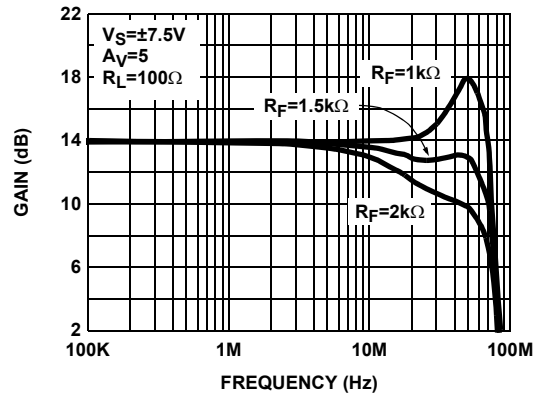

FIGURE 8. DIFFERENTIAL FREQUENCY RESPONSE (FULL POWER MODE)

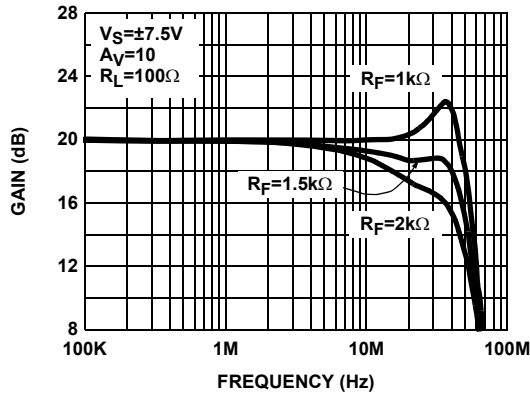

FIGURE 9. DIFFERENTIAL FREQUENCY RESPONSE (3/4 POWER MODE)

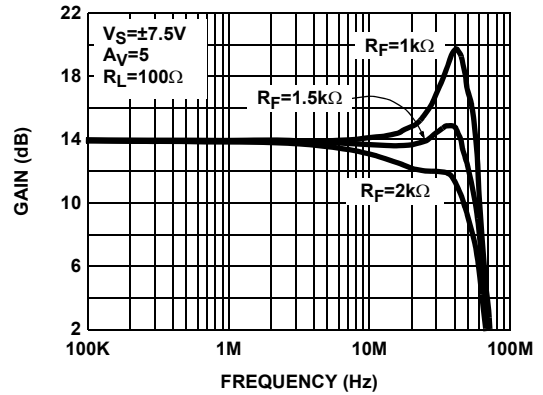

FIGURE 10. DIFFERENTIAL FREQUENCY RESPONSE (3/4 POWER MODE)

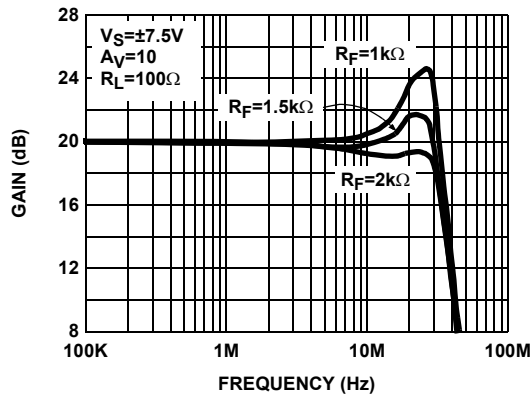

FIGURE 11. DIFFERENTIAL FREQUENCY RESPONSE (1/2 POWER MODE)

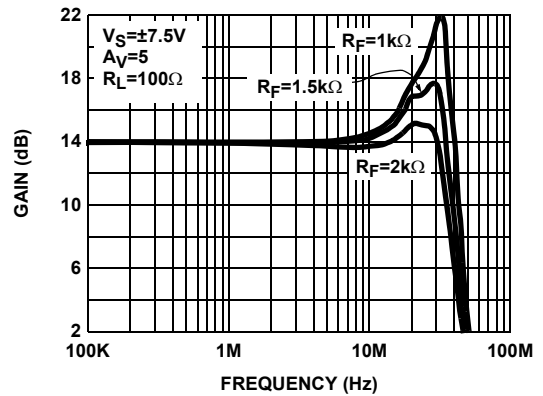

FIGURE 12. DIFFERENTIAL FREQUENCY RESPONSE (1/2 POWER MODE)

**Typical Performance Curves** (Continued)

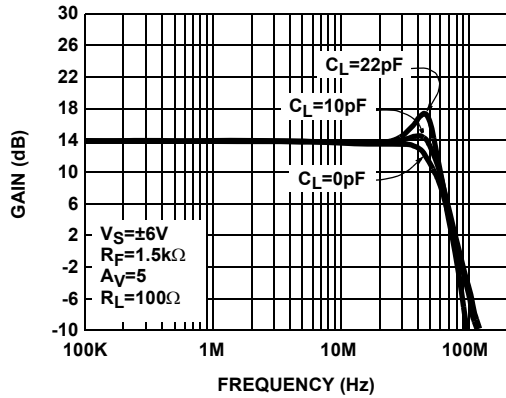

FIGURE 13. DIFFERENTIAL FREQUENCY RESPONSE vs  $C_L$  (FULL POWER MODE)

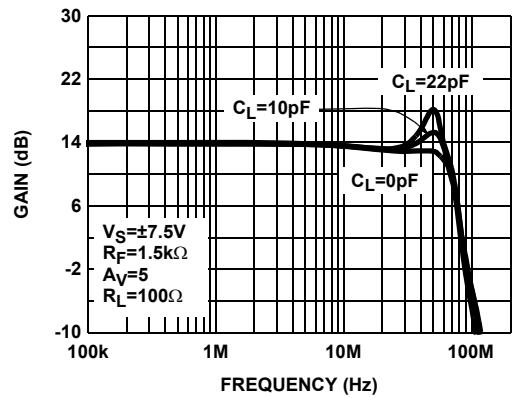

FIGURE 14. DIFFERENTIAL FREQUENCY RESPONSE vs  $C_L$  (FULL POWER MODE)

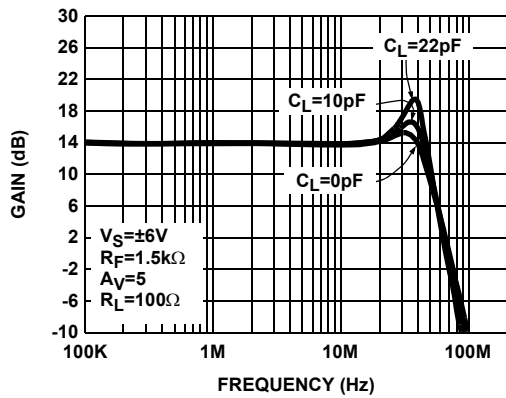

FIGURE 15. DIFFERENTIAL FREQUENCY RESPONSE vs  $C_L$  (3/4 POWER MODE)

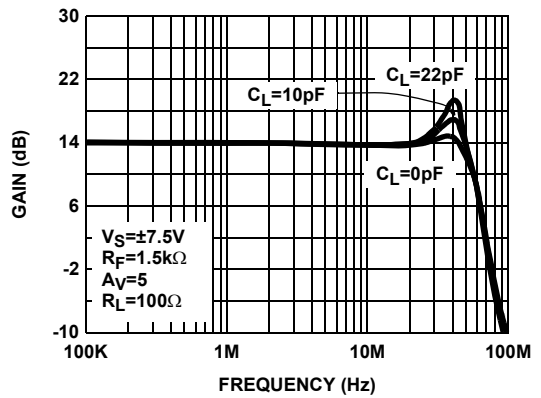

FIGURE 16. DIFFERENTIAL FREQUENCY RESPONSE vs  $C_L$  (3/4 POWER MODE)

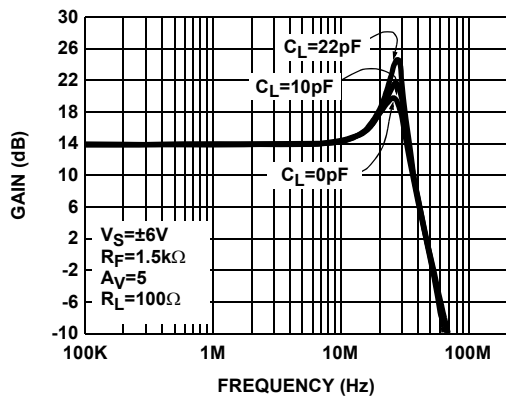

FIGURE 17. DIFFERENTIAL FREQUENCY RESPONSE vs  $C_L$  (1/2 POWER MODE)

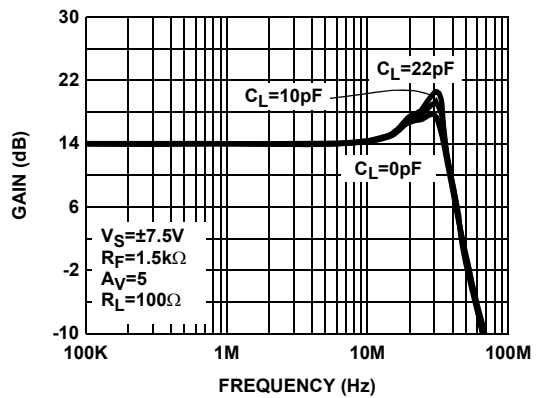

FIGURE 18. DIFFERENTIAL FREQUENCY RESPONSE vs  $C_L$  (1/2 POWER MODE)

**Typical Performance Curves** (Continued)

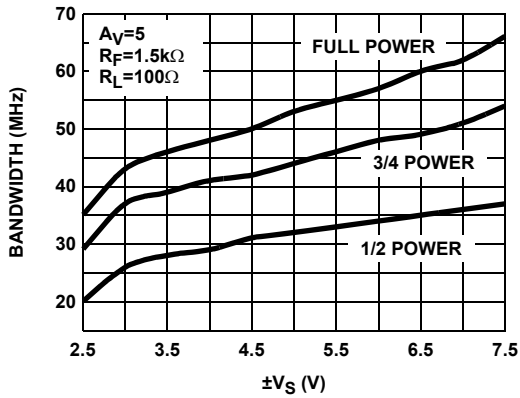

FIGURE 19. DIFFERENTIAL BANDWIDTH vs SUPPLY VOLTAGE

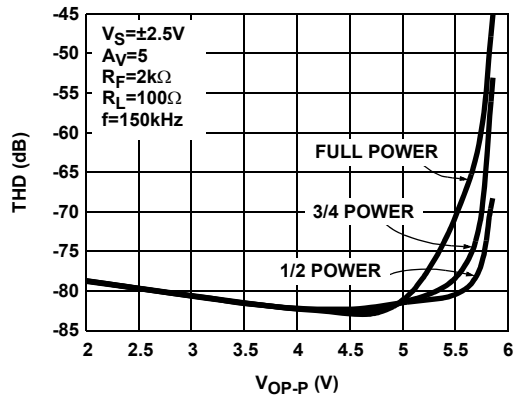

FIGURE 20. DIFFERENTIAL TOTAL HARMONIC DISTORTION vs DIFFERENTIAL OUTPUT VOLTAGE

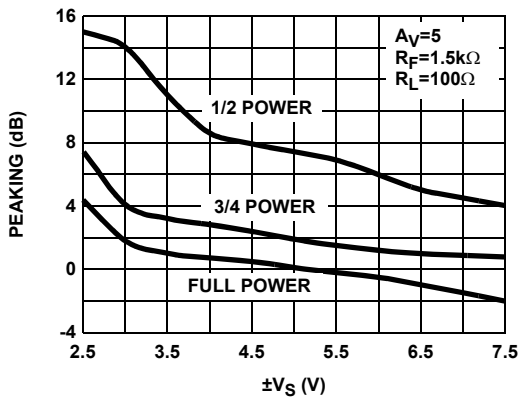

FIGURE 21. DIFFERENTIAL PEAKING vs SUPPLY VOLTAGE

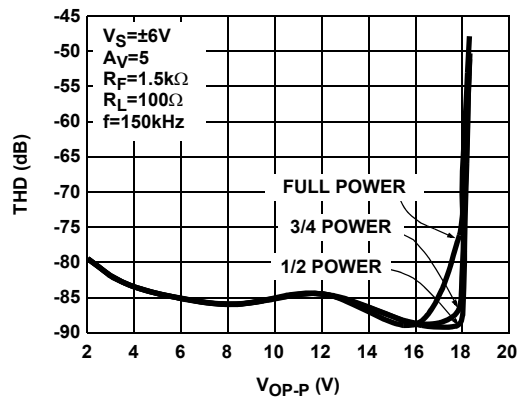

FIGURE 22. DIFFERENTIAL TOTAL HARMONIC DISTORTION vs DIFFERENTIAL OUTPUT VOLTAGE

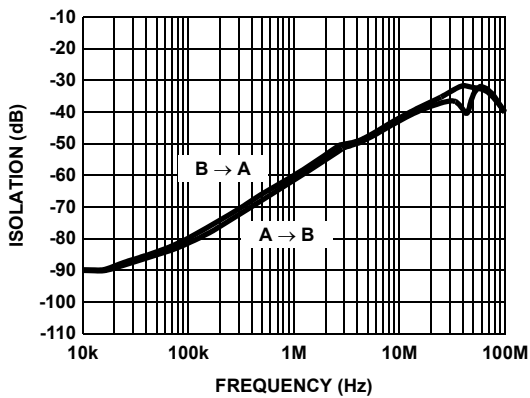

FIGURE 23. CHANNEL ISOLATION vs FREQUENCY

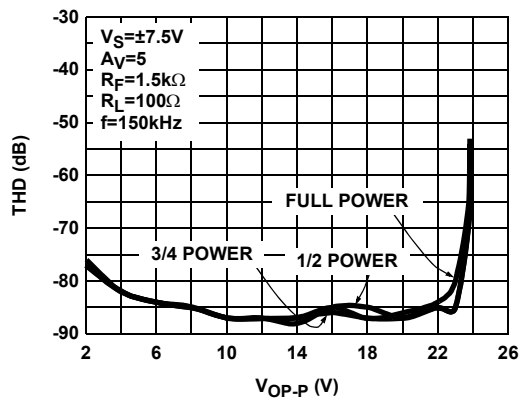

FIGURE 24. DIFFERENTIAL TOTAL HARMONIC DISTORTION vs DIFFERENTIAL OUTPUT VOLTAGE



**Typical Performance Curves** (Continued)

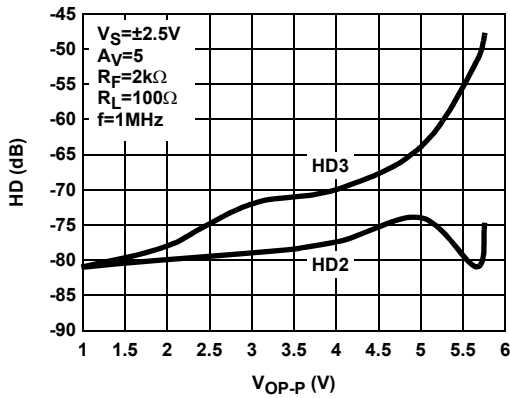

FIGURE 25. DIFFERENTIAL HARMONIC DISTORTION vs DIFFERENTIAL OUTPUT VOLTAGE (FULL POWER MODE)

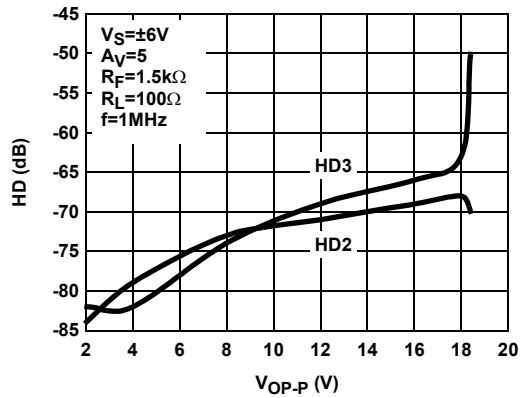

FIGURE 26. DIFFERENTIAL HARMONIC DISTORTION vs DIFFERENTIAL OUTPUT VOLTAGE (FULL POWER MODE)

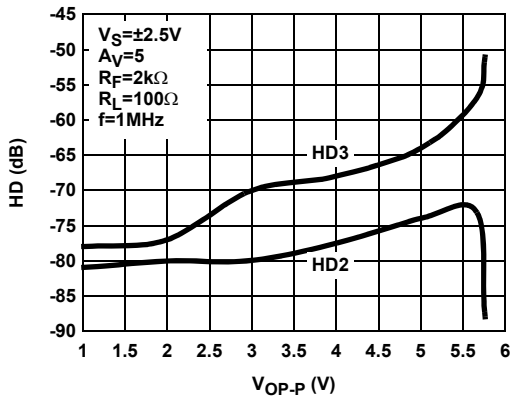

FIGURE 27. DIFFERENTIAL HARMONIC DISTORTION vs DIFFERENTIAL OUTPUT VOLTAGE (3/4 POWER MODE)

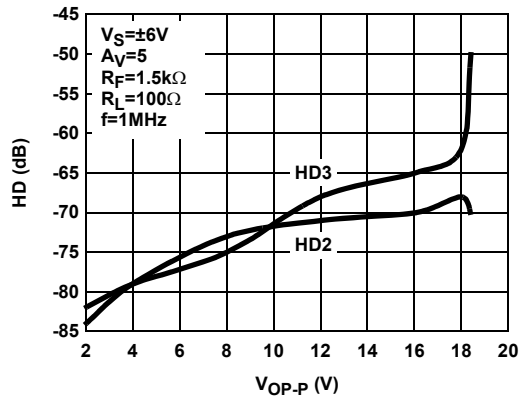

FIGURE 28. DIFFERENTIAL HARMONIC DISTORTION vs DIFFERENTIAL OUTPUT VOLTAGE (3/4 POWER MODE)

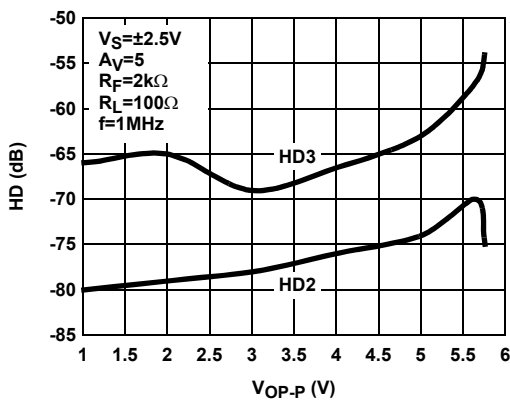

FIGURE 29. DIFFERENTIAL HARMONIC DISTORTION vs DIFFERENTIAL OUTPUT VOLTAGE (1/2 POWER MODE)

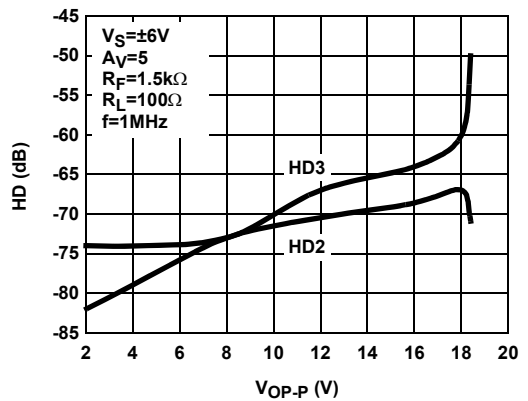

FIGURE 30. DIFFERENTIAL HARMONIC DISTORTION vs DIFFERENTIAL OUTPUT VOLTAGE (1/2 POWER MODE)

**Typical Performance Curves** (Continued)

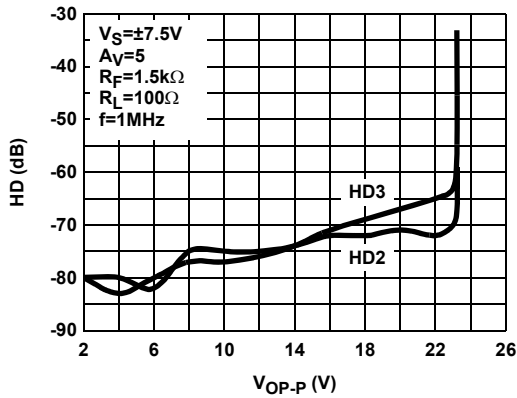

FIGURE 31. DIFFERENTIAL HARMONIC DISTORTION vs DIFFERENTIAL OUTPUT VOLTAGE (FULL POWER MODE)

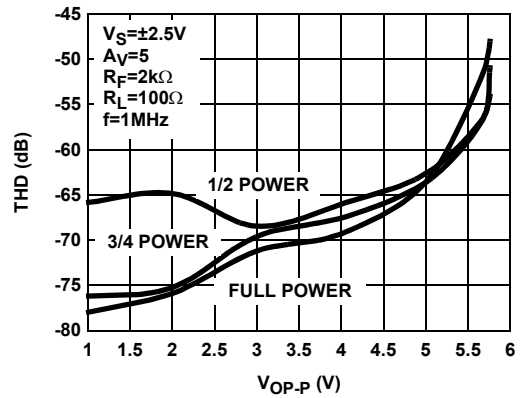

FIGURE 32. DIFFERENTIAL TOTAL HARMONIC DISTORTION vs DIFFERENTIAL OUTPUT VOLTAGE

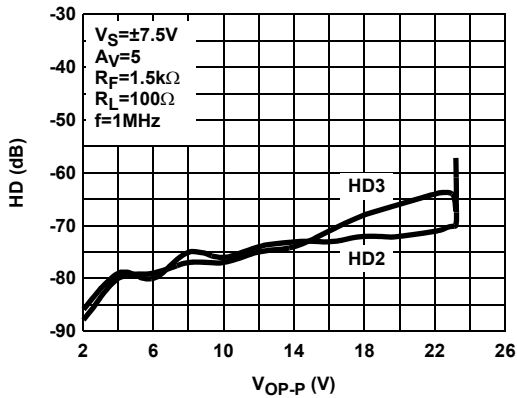

FIGURE 33. DIFFERENTIAL HARMONIC DISTORTION vs DIFFERENTIAL OUTPUT VOLTAGE (3/4 POWER MODE)

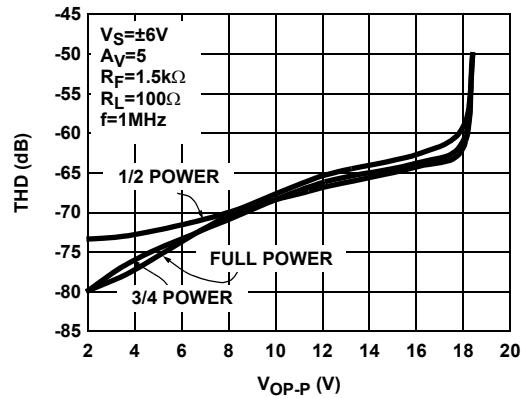

FIGURE 34. DIFFERENTIAL TOTAL HARMONIC DISTORTION vs DIFFERENTIAL OUTPUT VOLTAGE

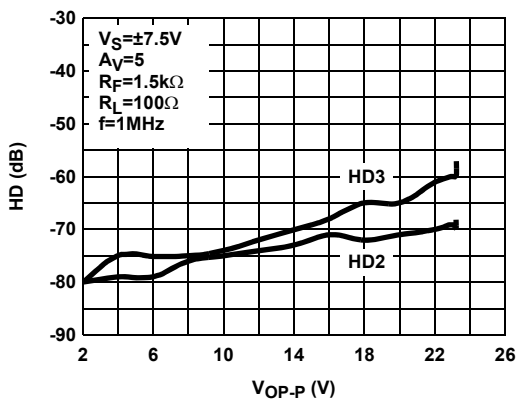

FIGURE 35. DIFFERENTIAL HARMONIC DISTORTION vs DIFFERENTIAL OUTPUT VOLTAGE (1/2 POWER MODE)

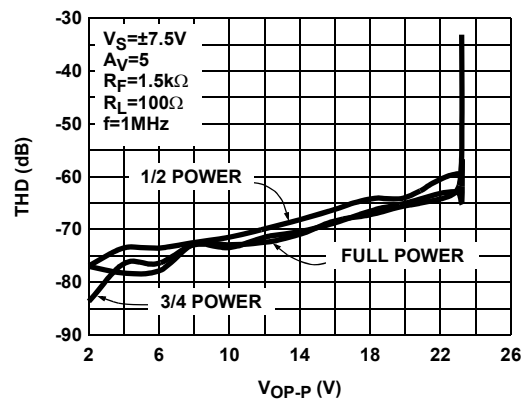

FIGURE 36. DIFFERENTIAL TOTAL HARMONIC DISTORTION vs DIFFERENTIAL OUTPUT VOLTAGE

**Typical Performance Curves** (Continued)

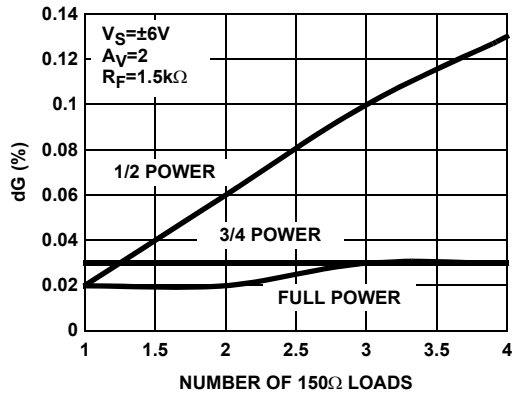

FIGURE 37. DIFFERENTIAL GAIN

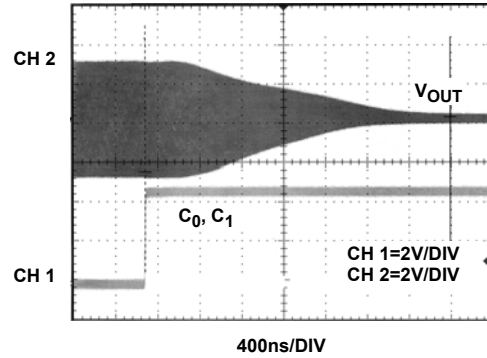

FIGURE 38. DISABLE TIME

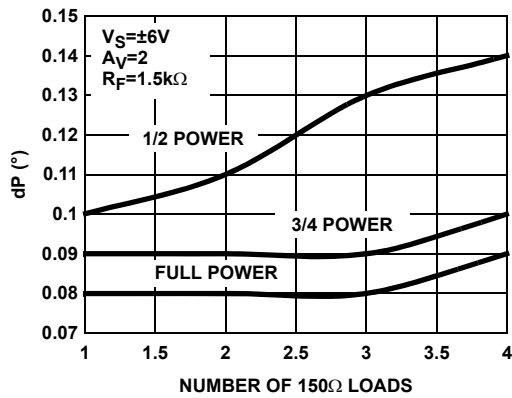

FIGURE 39. DIFFERENTIAL PHASE

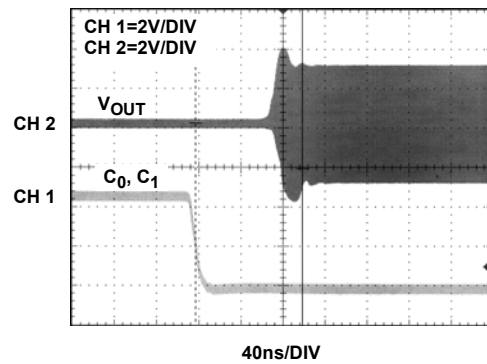

FIGURE 40. ENABLE TIME

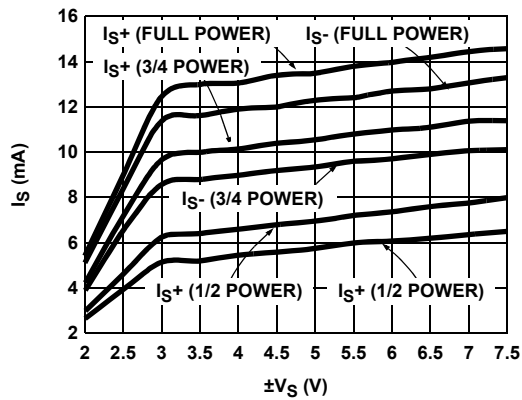

FIGURE 41. SUPPLY CURRENT vs SUPPLY VOLTAGE

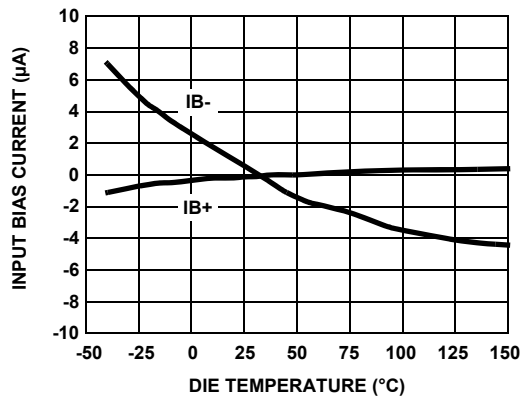

FIGURE 42. INPUT BIAS CURRENT vs TEMPERATURE

**Typical Performance Curves** (Continued)

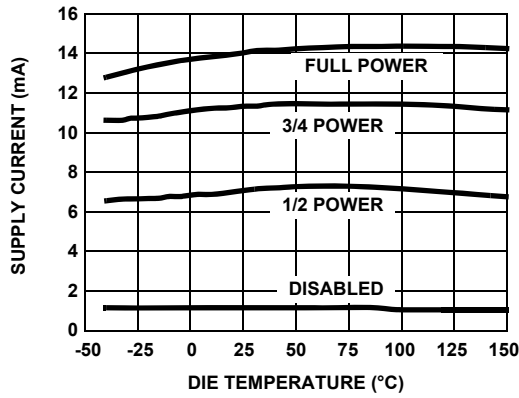

FIGURE 43. POSITIVE SUPPLY CURRENT vs TEMPERATURE

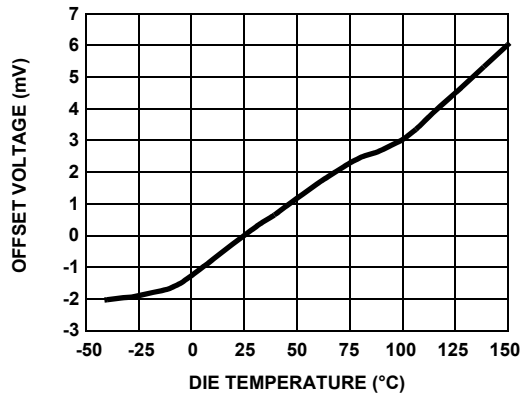

FIGURE 44. OFFSET VOLTAGE vs TEMPERATURE

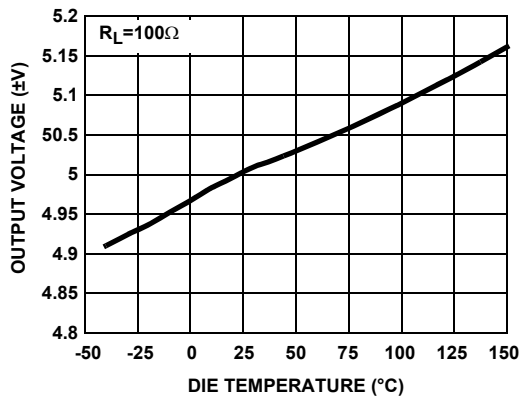

FIGURE 45. OUTPUT VOLTAGE vs TEMPERATURE

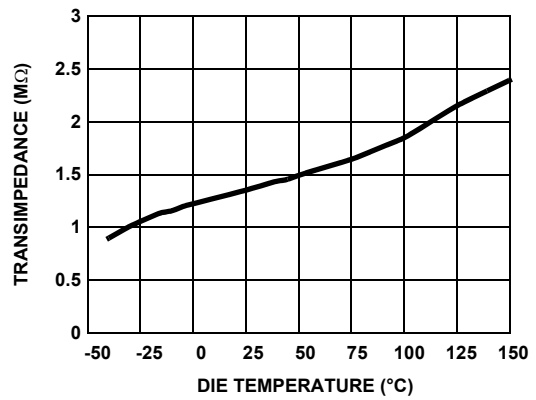

FIGURE 46. TRANSIMPEDANCE vs TEMPERATURE

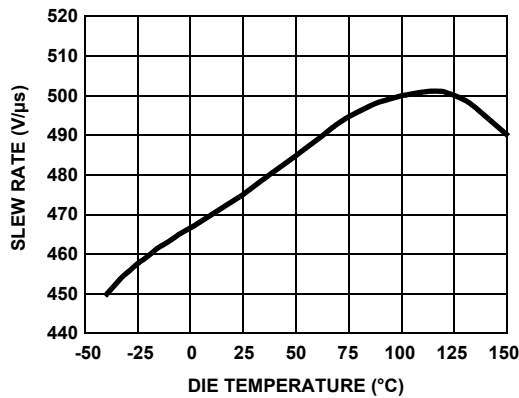

FIGURE 47. SLEW RATE vs TEMPERATURE

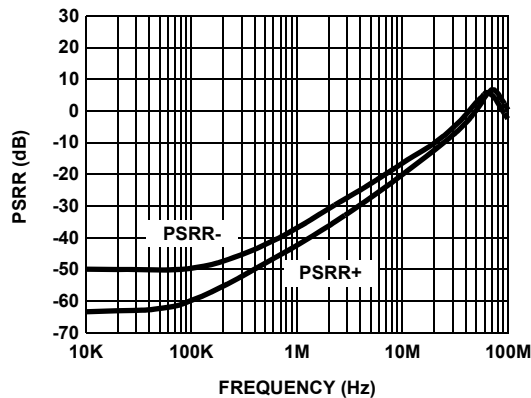

FIGURE 48. POWER SUPPLY REJECTION vs FREQUENCY

**Typical Performance Curves** (Continued)

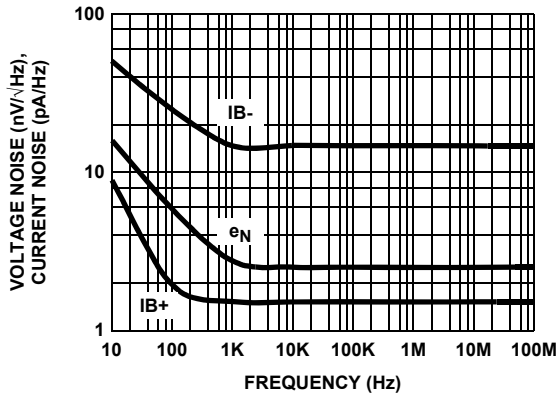

FIGURE 49. VOLTAGE AND CURRENT NOISE vs FREQUENCY

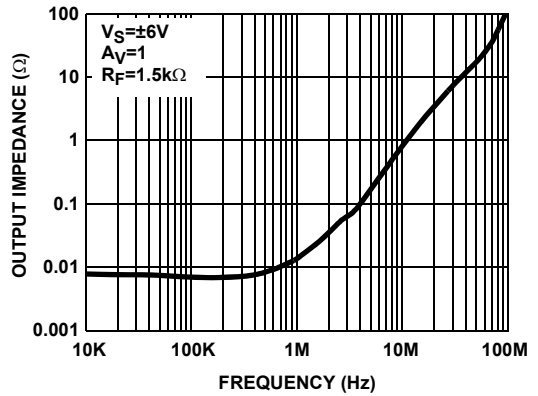

FIGURE 50. OUTPUT IMPEDANCE vs FREQUENCY (ALL POWER LEVELS)

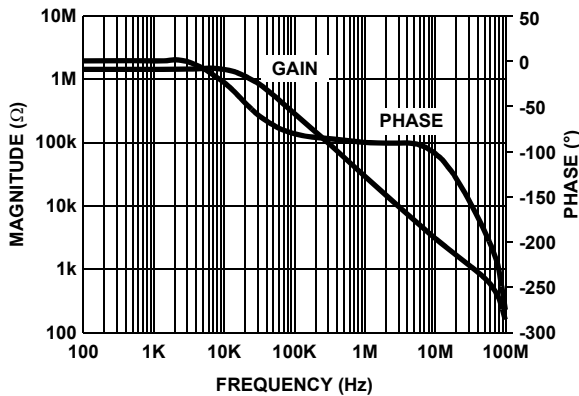

FIGURE 51. TRANSIMPEDANCE (ROL) vs FREQUENCY

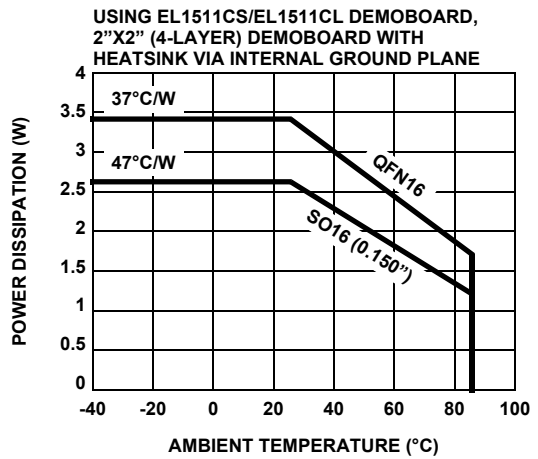

FIGURE 52. PACKAGE POWER DISSIPATION AND THERMAL RESISTANCE

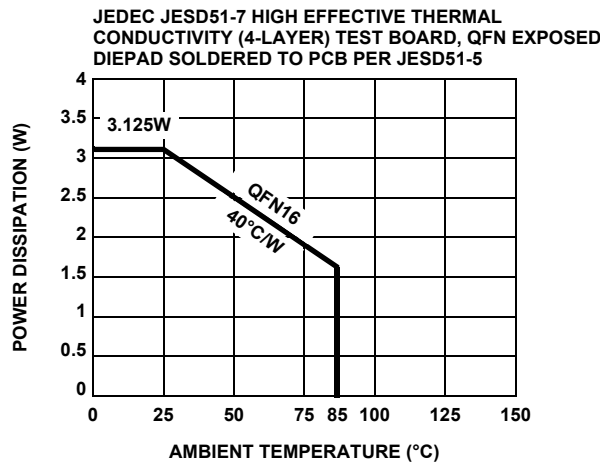

FIGURE 53. PACKAGE POWER DISSIPATION vs AMBIENT TEMPERATURE

## Applications Information

### Product Description

The EL1511 is a dual operational amplifier designed for customer premise driver functions in DMT ADSL solutions and is built using Elantec's proprietary complimentary bipolar process. Due to the current feedback architecture, the EL1511 closed-loop 3dB bandwidth is dependent on the value of the feedback resistor. First the desired bandwidth is selected by choosing the feedback resistor,  $R_F$ , and then the gain is set by picking the gain resistor,  $R_G$ . The curves at the beginning of the Typical Performance Curves section show the effect of varying both  $R_F$  and  $R_G$ .

### Power Supply Bypassing and Printed Circuit Board Layout

As with any high frequency device, good printed circuit board layout is necessary for optimum performance. Ground plane construction is highly recommended. Lead lengths should be as short as possible, below  $\frac{1}{4}$ ". The power supply pins must be well bypassed to reduce the risk of oscillation. A 1.0 $\mu$ F tantalum capacitor in parallel with a 0.01 $\mu$ F ceramic capacitor is adequate for each supply pin.

For good AC performance, parasitic capacitances should be kept to a minimum, especially at the inverting input (see Capacitance at the Inverting Input section). This implies keeping the ground plane away from this pin. Carbon resistors are acceptable, while use of wire-wound resistors should not be used because of their parasitic inductance. Similarly, capacitors should be low inductance for best performance. Use of sockets, particularly for the SO (0.150") package, should be avoided. Sockets add parasitic inductance and capacitance which will result in peaking and overshoot.

### Capacitance at the Inverting Input

Due to the topology of the current feedback amplifier, stray capacitance at the inverting input will affect the AC and transient performance of the EL1511 when operating in the non-inverting configuration.

In the inverting gain mode, added capacitance at the inverting input has little effect since this point is at a virtual ground and stray capacitance is therefore not "seen" by the amplifier.

### Feedback Resistor Values

The EL1511 has been designed and specified with  $R_F = 1.5k\Omega$  for  $A_V = +5$ . This value of feedback resistor yields relatively flat frequency response with <1.5dB peaking out to 60MHz. As is the case with all current feedback amplifiers, wider bandwidth, at the expense of slight peaking, can be obtained by reducing the value of the feedback resistor. Inversely, larger values of feedback resistor will cause rolloff to occur at a lower frequency. By reducing  $R_F$  to 1k $\Omega$ , bandwidth can be extended to 70MHz with 3.0dB of peaking. See the curves in the Typical Performance Curves section which show 3dB bandwidth and peaking vs frequency for various feedback resistors.

### Power Dissipation

The EL1511 amplifier combines both high speed and large output current drive capability at a moderate supply current in very small packages. It is possible to exceed the maximum junction temperature allowed under certain supply voltage, temperature, and loading conditions. To ensure that the EL1511 remains within its absolute maximum ratings, the following discussion will help to avoid exceeding the maximum junction temperature.

The maximum power dissipation allowed in a package is determined by its thermal resistance and the amount of temperature rise according to:

$$P_{DMAX} = \frac{T_{JMAX} - T_{AMAX}}{\theta_{JA}}$$

The maximum power dissipation actually produced by an IC is the total quiescent supply current times the total power supply voltage plus the power in the IC due to the load, or:

$$P_{DMAX} = 2 \times V_S + (V_S - V_{OUT}) \times \frac{V_{OUT}}{R_L}$$

where  $I_S$  is the supply current. (To be more accurate, the quiescent supply current flowing in the output driver transistor should be subtracted from the first term because, under loading and due to the class AB nature of the output stage, the output driver current is now included in the second term.)

In general, an amplifier's AC performance degrades at higher operating temperature and lower supply current. Unlike some amplifiers, the EL1511 maintains almost constant supply current over temperature so that AC performance is not degraded as much over the entire operating temperature range.

### Estimating Line Driver Power Dissipation in ADSL CPE Application

The below figure shows a typical ADSL CPE line driver implementation. The average line power requirement for the ADSL CPE application is 13dBm (20mW) into a 100W line. The average line voltage is 1.41V<sub>RMS</sub>. The ADSL DMT peak to average ratio (crest factor) of 5.3 implies peak voltage of 7.5V into the line. Using a differential drive configuration and transformer coupling with standard back termination, a transformer ratio of 1:2 is selected. With 1:2 transformer ratio, the impedance across the driver side of the transformer is 25 $\Omega$ , the average voltage is 0.705V<sub>RMA</sub> and the average current is 28.2mA. The power dissipated in the EL1511 is a combination of the quiescent power and the output stage power when driving the line:

$$PD = P_{\text{quiescent}} + P_{\text{output-stage}}$$

$$PD = V_S \times I_Q + (V_S - 2 \times V_{\text{OUT-RMS}}) \times I_{\text{OUT-RMS}}$$

In the  $\frac{1}{2}$  power mode, the EL1511 consumes typically 6.6mA quiescent current and still able to maintain very low distortion. The distortion results are shown in typical

performance section of the data sheet. When driving a load, a large portion (about 50%) of the quiescent current becomes output load current:

$$PD = 12 \times (6.6\text{mA} \times 50\%) + (12\text{V} - 2 \times 0.705) \times 28.2\text{mA}$$

where:

$$PD = 338\text{mW}$$

Assuming a maximum ambient temperature of 85°C and keeping the junction temperature less than 150°C, the maximum thermal resistance from junction to ambient required is:

$$\theta_{JA} = \frac{150 - 85}{338\text{mW}} = 192^\circ\text{C/W}$$

With proper layout, the EL1511CS package can achieve 47°C/W, well below the thermal resistance required by the application.

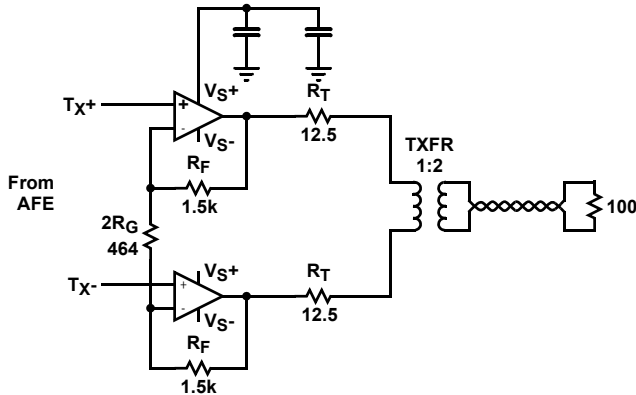

**PCB Layout Considerations for Thermal Packages**

The EL1511 die is packaged in two different thermal efficient packages, the 16 Ld SO and 16 Ld QFN packages. The 16 Ld SO package has the same dimensions as standard 0.15" wide narrow body 16 Ld SO package with a special fused lead frame that extends out through the center ground pins. Both packages can use PCB surface metal vias areas and internal ground planes, to spread heat away from the package. The larger the PCB area the lower the junction temperature of the device will be. In XDSL applications, multiple layer circuit boards with internal ground plane are generally used. 13 mil vias are recommended to connect the metal area under the device with the internal ground plane. Examples of the PCB layouts are shown in the figures below that result in thermal resistance  $\theta_{JA}$  of 37°C/W for the QFN package and 47°C/W for the SO package. The thermal resistance is obtained with the EL1511CL and CS demo boards. The demo board is a 4-layer board built with 2oz. copper and has a dimension of 4in<sup>2</sup>. Note, the user must follow the thermal layout guideline to achieve these results.

A separate Application Note for the QFN package and layout recommendations is also available.

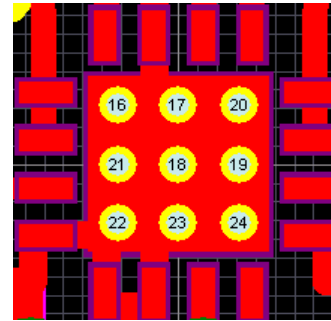

TOP (16 Ld QFN)

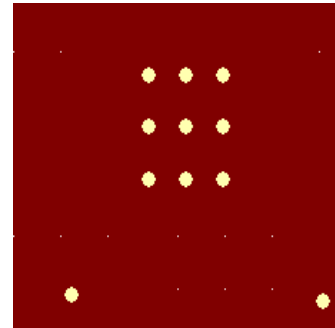

INTERNAL GROUND PLANE (16 Ld QFN)

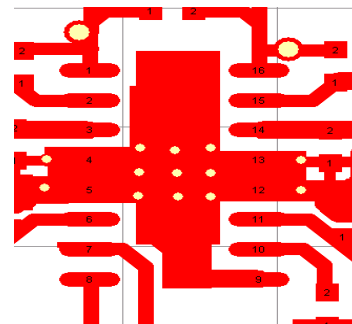

TOP (16 Ld SO)

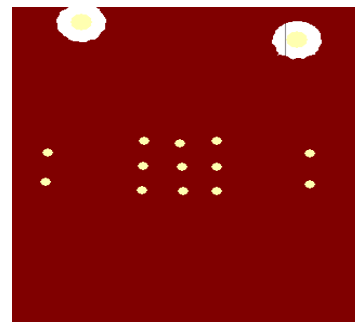

INTERNAL GROUND PLANE (16 Ld SO)

**QFN (Quad Flat No-Lead) Package Family**

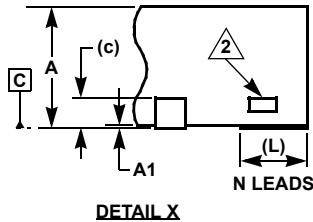
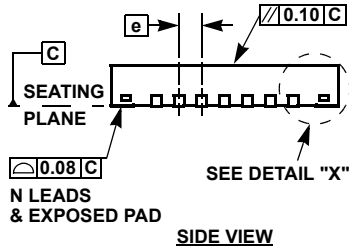
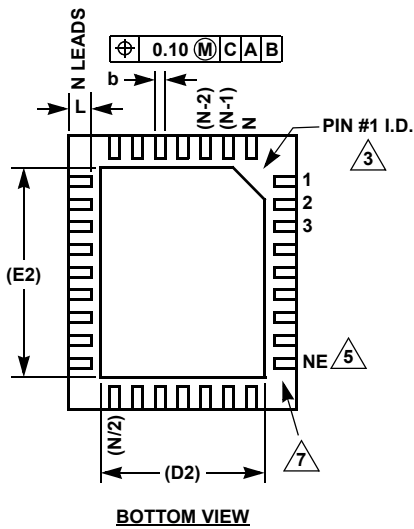
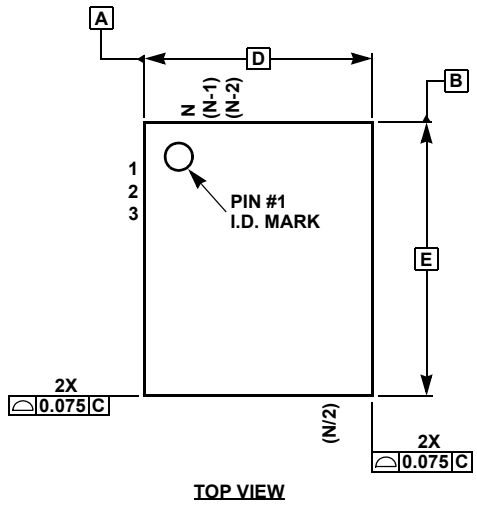

**MDP0046**

**QFN (QUAD FLAT NO-LEAD) PACKAGE FAMILY  
(COMPLIANT TO JEDEC MO-220)**

| SYMBOL | MILLIMETERS |       |       |           | TOLERANCE   | NOTES |
|--------|-------------|-------|-------|-----------|-------------|-------|
|        | QFN44       | QFN38 | QFN32 |           |             |       |
| A      | 0.90        | 0.90  | 0.90  | 0.90      | ±0.10       | -     |
| A1     | 0.02        | 0.02  | 0.02  | 0.02      | +0.03/-0.02 | -     |
| b      | 0.25        | 0.25  | 0.23  | 0.22      | ±0.02       | -     |
| c      | 0.20        | 0.20  | 0.20  | 0.20      | Reference   | -     |
| D      | 7.00        | 5.00  | 8.00  | 5.00      | Basic       | -     |
| D2     | 5.10        | 3.80  | 5.80  | 3.60/2.48 | Reference   | 8     |
| E      | 7.00        | 7.00  | 8.00  | 6.00      | Basic       | -     |
| E2     | 5.10        | 5.80  | 5.80  | 4.60/3.40 | Reference   | 8     |
| e      | 0.50        | 0.50  | 0.80  | 0.50      | Basic       | -     |
| L      | 0.55        | 0.40  | 0.53  | 0.50      | ±0.05       | -     |
| N      | 44          | 38    | 32    | 32        | Reference   | 4     |
| ND     | 11          | 7     | 8     | 7         | Reference   | 6     |
| NE     | 11          | 12    | 8     | 9         | Reference   | 5     |

| SYMBOL | MILLIMETERS |       |       |      |       | TOLERANCE   | NOTES |
|--------|-------------|-------|-------|------|-------|-------------|-------|
|        | QFN28       | QFN24 | QFN20 |      | QFN16 |             |       |
| A      | 0.90        | 0.90  | 0.90  | 0.90 | 0.90  | ±0.10       | -     |
| A1     | 0.02        | 0.02  | 0.02  | 0.02 | 0.02  | +0.03/-0.02 | -     |
| b      | 0.25        | 0.25  | 0.30  | 0.25 | 0.33  | ±0.02       | -     |
| c      | 0.20        | 0.20  | 0.20  | 0.20 | 0.20  | Reference   | -     |
| D      | 4.00        | 4.00  | 5.00  | 4.00 | 4.00  | Basic       | -     |
| D2     | 2.65        | 2.80  | 3.70  | 2.70 | 2.40  | Reference   | -     |
| E      | 5.00        | 5.00  | 5.00  | 4.00 | 4.00  | Basic       | -     |
| E2     | 3.65        | 3.80  | 3.70  | 2.70 | 2.40  | Reference   | -     |
| e      | 0.50        | 0.50  | 0.65  | 0.50 | 0.65  | Basic       | -     |
| L      | 0.40        | 0.40  | 0.40  | 0.40 | 0.60  | ±0.05       | -     |
| N      | 28          | 24    | 20    | 20   | 16    | Reference   | 4     |
| ND     | 6           | 5     | 5     | 5    | 4     | Reference   | 6     |
| NE     | 8           | 7     | 5     | 5    | 4     | Reference   | 5     |

Rev 11 2/07

**NOTES:**

1. Dimensioning and tolerancing per ASME Y14.5M-1994.
2. Tiebar view shown is a non-functional feature.
3. Bottom-side pin #1 I.D. is a diepad chamfer as shown.
4. N is the total number of terminals on the device.
5. NE is the number of terminals on the "E" side of the package (or Y-direction).
6. ND is the number of terminals on the "D" side of the package (or X-direction). ND = (N/2)-NE.
7. Inward end of terminal may be square or circular in shape with radius (b/2) as shown.
8. If two values are listed, multiple exposed pad options are available. Refer to device-specific datasheet.



**Small Outline Package Family (SO)**

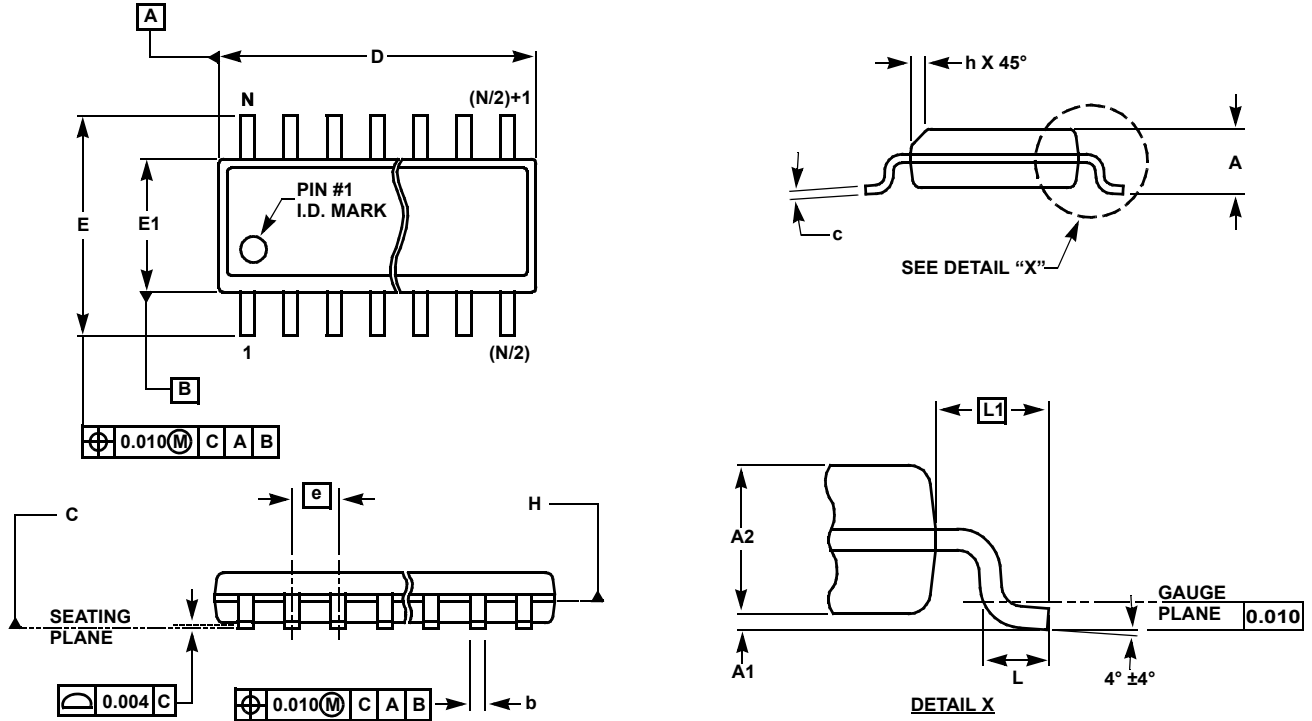

**MDP0027**

**SMALL OUTLINE PACKAGE FAMILY (SO)**

| SYMBOL | INCHES |       |               |                        |               |               |               | TOLERANCE | NOTES |
|--------|--------|-------|---------------|------------------------|---------------|---------------|---------------|-----------|-------|
|        | SO-8   | SO-14 | SO16 (0.150") | SO16 (0.300") (SOL-16) | SO20 (SOL-20) | SO24 (SOL-24) | SO28 (SOL-28) |           |       |
| A      | 0.068  | 0.068 | 0.068         | 0.104                  | 0.104         | 0.104         | 0.104         | MAX       | -     |
| A1     | 0.006  | 0.006 | 0.006         | 0.007                  | 0.007         | 0.007         | 0.007         | ±0.003    | -     |
| A2     | 0.057  | 0.057 | 0.057         | 0.092                  | 0.092         | 0.092         | 0.092         | ±0.002    | -     |
| b      | 0.017  | 0.017 | 0.017         | 0.017                  | 0.017         | 0.017         | 0.017         | ±0.003    | -     |
| c      | 0.009  | 0.009 | 0.009         | 0.011                  | 0.011         | 0.011         | 0.011         | ±0.001    | -     |
| D      | 0.193  | 0.341 | 0.390         | 0.406                  | 0.504         | 0.606         | 0.704         | ±0.004    | 1, 3  |
| E      | 0.236  | 0.236 | 0.236         | 0.406                  | 0.406         | 0.406         | 0.406         | ±0.008    | -     |
| E1     | 0.154  | 0.154 | 0.154         | 0.295                  | 0.295         | 0.295         | 0.295         | ±0.004    | 2, 3  |
| e      | 0.050  | 0.050 | 0.050         | 0.050                  | 0.050         | 0.050         | 0.050         | Basic     | -     |
| L      | 0.025  | 0.025 | 0.025         | 0.030                  | 0.030         | 0.030         | 0.030         | ±0.009    | -     |
| L1     | 0.041  | 0.041 | 0.041         | 0.056                  | 0.056         | 0.056         | 0.056         | Basic     | -     |
| h      | 0.013  | 0.013 | 0.013         | 0.020                  | 0.020         | 0.020         | 0.020         | Reference | -     |
| N      | 8      | 14    | 16            | 16                     | 20            | 24            | 28            | Reference | -     |

Rev. M 2/07

**NOTES:**

1. Plastic or metal protrusions of 0.006" maximum per side are not included.
2. Plastic interlead protrusions of 0.010" maximum per side are not included.
3. Dimensions "D" and "E1" are measured at Datum Plane "H".
4. Dimensioning and tolerancing per ASME Y14.5M-1994

**© Copyright Intersil Americas LLC 2005-2007. All Rights Reserved.  
All trademarks and registered trademarks are the property of their respective owners.**

For additional products, see [www.intersil.com/en/products.html](http://www.intersil.com/en/products.html)

---

Intersil products are manufactured, assembled and tested utilizing ISO9001 quality systems as noted in the quality certifications found at [www.intersil.com/en/support/qualandreliability.html](http://www.intersil.com/en/support/qualandreliability.html)

---

*Intersil products are sold by description only. Intersil may modify the circuit design and/or specifications of products at any time without notice, provided that such modification does not, in Intersil's sole judgment, affect the form, fit or function of the product. Accordingly, the reader is cautioned to verify that datasheets are current before placing orders. Information furnished by Intersil is believed to be accurate and reliable. However, no responsibility is assumed by Intersil or its subsidiaries for its use; nor for any infringements of patents or other rights of third parties which may result from its use. No license is granted by implication or otherwise under any patent or patent rights of Intersil or its subsidiaries.*

---

For information regarding Intersil Corporation and its products, see [www.intersil.com](http://www.intersil.com)