

EL1516, EL1516A

Dual Ultra Low Noise Amplifier

NOT RECOMMENDED FOR NEW DESIGNS
 NO RECOMMENDED REPLACEMENT
 contact our Technical Support Center at
 1-888-INTERSIL or www.intersil.com/tsc

FN7328
 Rev 2.00
 May 3, 2007

The EL1516 is a dual, ultra low noise amplifier, ideally suited to line receiving applications in ADSL, VDSL, and home PNA designs. With low noise specification of just $1.3nV/\sqrt{Hz}$ and $1.5pA/\sqrt{Hz}$, the EL1516 is perfect for the detection of very low amplitude signals.

The EL1516 features a -3dB bandwidth of 350MHz @ $A_V = -1$ and is gain-of-2 stable. The EL1516 also affords minimal power dissipation with a supply current of just 5.5mA per amplifier. The amplifier can be powered from supplies ranging from 5V to 12V.

The EL1516A incorporates an enable and disable function to reduce the supply current to 5nA typical per amplifier, allowing the \overline{EN} pins to float or apply a low logic level will enable the amplifiers.

The EL1516 is available in space-saving 8 Ld MSOP and industry-standard 8 Ld SOIC packages and the EL1516A is available in a 10 Ld MSOP package. All are specified for operation over the $-40^{\circ}C$ to $+85^{\circ}C$ temperature range.

Pinouts

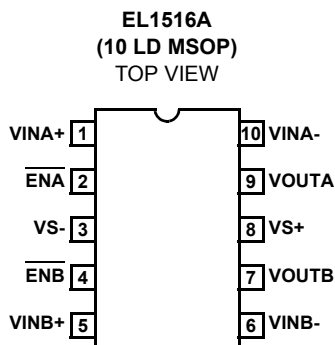
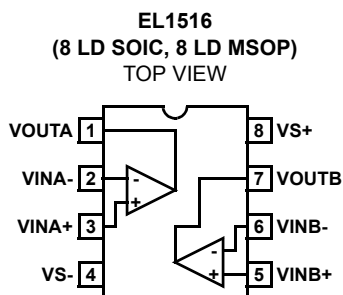

Features

- EL2227 upgrade replacement
- Voltage noise of only $1.3nV/\sqrt{Hz}$
- Current noise of only $1.5pA/\sqrt{Hz}$
- Bandwidth (-3dB) of 350MHz @ $A_V = -1$
- Bandwidth (-3dB) of 250MHz @ $A_V = +2$
- Gain-of-2 stable
- Just 5.5mA per amplifier
- 100mA I_{OUT}
- Fast enable/disable (EL1516A only)
- 5V to 12V operation
- Pb-free plus anneal available (RoHS compliant)

Applications

- ADSL receivers
- VDSL receivers
- Home PNA receivers
- Ultrasound input amplifiers
- Wideband instrumentation
- Communications equipment
- AGC and PLL active filters
- Wideband sensors

Ordering Information

PART NUMBER	PART MARKING	TAPE AND REEL	PACKAGE	PKG. DWG. #
EL1516IY	BAAHA	-	8 Ld MSOP (3.0mm)	MDP0043
EL1516IY-T13	BAAHA	13"	8 Ld MSOP (3.0mm)	MDP0043
EL1516IY-T7	BAAHA	7"	8 Ld MSOP (3.0mm)	MDP0043
EL1516IYZ (Note)	BAAAY	-	8 Ld MSOP (Pb-free) (3.0mm)	MDP0043
EL1516IYZ-T13 (Note)	BAAAY	13"	8 Ld MSOP (Pb-free) (3.0mm)	MDP0043
EL1516IYZ-T7 (Note)	BAAAY	7"	8 Ld MSOP (Pb-free) (3.0mm)	MDP0043
EL1516IS	1516IS	-	8 Ld SOIC (150 mil)	MDP0027
EL1516IS-T13	1516IS	13"	8 Ld SOIC (150 mil)	MDP0027
EL1516IS-T7	1516IS	7"	8 Ld SOIC (150 mil)	MDP0027
EL1516ISZ (Note)	1516ISZ	-	8 Ld SOIC (Pb-free) (150 mil)	MDP0027
EL1516ISZ-T13 (Note)	1516ISZ	13"	8 Ld SOIC (Pb-free) (150 mil)	MDP0027
EL1516ISZ-T7 (Note)	1516ISZ	7"	8 Ld SOIC (Pb-free) (150 mil)	MDP0027
EL1516AIY	BBDAA	-	10 Ld MSOP (3.0mm)	MDP0043
EL1516AIY-T13	BBDAA	13"	10 Ld MSOP (3.0mm)	MDP0043
EL1516AIY-T7	BBDAA	7"	10 Ld MSOP (3.0mm)	MDP0043
EL1516AIYZ (Note)	BBEAA	-	10 Ld MSOP (Pb-free) (3.0mm)	MDP0043
EL1516AIYZ-T13 (Note)	BBEAA	13"	10 Ld MSOP (Pb-free) (3.0mm)	MDP0043
EL1516AIYZ-T7 (Note)	BBEAA	7"	10 Ld MSOP (Pb-free) (3.0mm)	MDP0043

NOTE: Intersil Pb-free plus anneal products employ special Pb-free material sets; molding compounds/die attach materials and 100% matte tin plate termination finish, which are RoHS compliant and compatible with both SnPb and Pb-free soldering operations. Intersil Pb-free products are MSL classified at Pb-free peak reflow temperatures that meet or exceed the Pb-free requirements of IPC/JEDEC J STD-020.

Absolute Maximum Ratings ($T_A = +25^\circ\text{C}$)

Supply Voltage between V_{S+} and V_{S-}	14V
Input Voltage	$V_{S-} -0.3\text{V}$, $V_{S+} +0.3\text{V}$
Maximum Continuous Output Current	40mA
Maximum Die Temperature	+150°C

Thermal Information

Storage Temperature	-65°C to +150°C
Operating Temperature	-40°C to +85°C
Power Dissipation	See Curves
Pb-free reflow profile	see link below
	http://www.intersil.com/pbfree/Pb-FreeReflow.asp

CAUTION: Stresses above those listed in "Absolute Maximum Ratings" may cause permanent damage to the device. This is a stress only rating and operation of the device at these or any other conditions above those indicated in the operational sections of this specification is not implied.

IMPORTANT NOTE: All parameters having Min/Max specifications are guaranteed. Typ values are for information purposes only. Unless otherwise noted, all tests are at the specified temperature and are pulsed tests, therefore: $T_J = T_C = T_A$

Electrical Specifications $V_{S+} = +2.5\text{V}$, $V_{S-} = -2.5\text{V}$, $R_L = 500\Omega$ and $C_L = 3\text{pF}$ to 0V, $R_F = R_G = 620\Omega$, $V_{CM} = 0\text{V}$, and $T_A = +25^\circ\text{C}$, Unless Otherwise Specified.

PARAMETER	DESCRIPTION	CONDITIONS	MIN	TYP	MAX	UNIT
INPUT CHARACTERISTICS						
V_{OS}	Input Offset Voltage	$V_{CM} = 0\text{V}$		-0.2	+3	mV
TCV_{OS}	Average Offset Voltage Drift			-0.3		$\mu\text{V}/^\circ\text{C}$
I_B	Input Bias Current	$V_{CM} = 0\text{V}$		6.5	9	μA
I_{OS}	Input Offset Current			50	500	nA
R_{IN}	Input Impedance			2		$\text{M}\Omega$
C_{IN}	Input Capacitance			1.6		pF
CMIR	Common-Mode Input Range		-1.3		+1.7	V
CMRR	Common-Mode Rejection Ratio	for V_{IN} from -4.7V to 5.4V	85	105		dB
A_{VOL}	Open-Loop Gain	$V_O = \pm 1.25\text{V}$	70	75		dB
e_n	Voltage Noise	$f = 100\text{kHz}$		1.24		$\text{nV}/\sqrt{\text{Hz}}$
i_n	Current Noise	$f = 100\text{kHz}$		1.5		$\text{pA}/\sqrt{\text{Hz}}$
OUTPUT CHARACTERISTICS						
V_{OL}	Output Swing Low	$R_L = 500\Omega$		1.45	1.35	V
		$R_L = 150\Omega$		1.37	1.25	V
V_{OH}	Output Swing High	$R_L = 500\Omega$	1.5	1.6		V
		$R_L = 150\Omega$	1.4	1.5		V
I_{SC}	Short Circuit Current	$R_L = 10\Omega$	60	75		mA
POWER SUPPLY PERFORMANCE						
PSRR	Power Supply Rejection Ratio	V_S is moved from $\pm 5.4\text{V}$ to $\pm 6.6\text{V}$	75	80		dB
$I_{S\ ON}$	Supply Current Enable (Per Amplifier)	No load		5.7	7	mA
$I_{S\ OFF}$	Supply Current Disable (Per Amplifier) (EL1516A)	I+ (DIS)		2	20	μA
		I- (DIS)	-21	-16		μA
$TC\ I_S$	I_S Temperature Coefficient			32		$\mu\text{A}/^\circ\text{C}$
V_S	Operating Range		5		12	V
DYNAMIC PERFORMANCE						
SR	Slew Rate	$V_O = \pm 1.25\text{V}$ square wave, measured 25% to 75%	80	110		$\text{V}/\mu\text{s}$
$TC\ SR$	SR Temperature Coefficient			0.5		$\text{V}/\mu\text{s}/^\circ\text{C}$
t_S	Settling to 0.1% ($A_V = +2$)	$A_V = +2$, $V_O = \pm 1\text{V}$		25		ns
BW1	-3dB Bandwidth	$A_V = -1$, $R_F = 100\Omega$		320		MHz
BW2	-3dB Bandwidth	$A_V = +2$, $R_F = 100\Omega$		200		MHz

Electrical Specifications $V_{S+} = +2.5V$, $V_{S-} = -2.5V$, $R_L = 500\Omega$ and $C_L = 3pF$ to $0V$, $R_F = R_G = 620\Omega$, $V_{CM} = 0V$, and $T_A = +25^\circ C$, Unless Otherwise Specified. (Continued)

PARAMETER	DESCRIPTION	CONDITIONS	MIN	TYP	MAX	UNIT
HD2	2nd Harmonic Distortion	$f = 1MHz$, $V_O = 2V_{P-P}$, $R_L = 100\Omega$		90		dBc
HD3	3rd Harmonic Distortion	$f = 1MHz$, $V_O = 2V_{P-P}$, $R_L = 100\Omega$		95		dBc
ENABLE (EL1516AIY ONLY)						
t_{EN}	Enable Time			125		ns
t_{DIS}	Disable Time			336		ns
I_{IHEN}	\overline{EN} Pin Input High Current	$\overline{EN} = V_{S+}$		18		μA
I_{ILEN}	\overline{EN} Pin Input Low Current	$\overline{EN} = V_{S-}$		10		nA
V_{IHEN}	\overline{EN} Pin Input High Voltage for Power-down			$V_{S+} - 1$		V
V_{IHEN}	\overline{EN} Pin Input Low Voltage for Power-up			$V_{S-} + 3$		V

Electrical Specifications $V_{S+} = +6V$, $V_{S-} = -6V$, $R_L = 500\Omega$ and $C_L = 3pF$ to $0V$, $R_F = R_G = 620\Omega$, $V_{CM} = 0V$, and $T_A = +25^\circ C$, Unless Otherwise Specified.

PARAMETER	DESCRIPTION	CONDITIONS	MIN	TYP	MAX	UNIT
INPUT CHARACTERISTICS						
V_{OS}	Input Offset Voltage	$V_{CM} = 0V$		0.1	3	mV
TCV_{OS}	Average Offset Voltage Drift			-0.3		$\mu V/^\circ C$
I_B	Input Bias Current	$V_{CM} = 0V$		6.5	9	μA
I_{OS}	Input Offset Current			50	500	nA
R_{IN}	Input Impedance			12		$M\Omega$
C_{IN}	Input Capacitance			1.6		pF
CMIR	Common-Mode Input Range		-4.5		+5.5	V
CMRR	Common-Mode Rejection Ratio	for V_{IN} from -4.7V to 5.4V	90	110		dB
A_{VOL}	Open-Loop Gain	$V_O = \pm 2.5V$	75	80		dB
e_n	Voltage Noise	$f = 100kHz$		1.24		nV/\sqrt{Hz}
i_n	Current Noise	$f = 100kHz$		1.5		pA/\sqrt{Hz}
OUTPUT CHARACTERISTICS						
V_{OL}	Output Swing Low	$R_L = 500\Omega$		-4.8	-4.7	V
		$R_L = 150\Omega$		-4.6	-4.5	V
V_{OH}	Output Swing High	$R_L = 500\Omega$	4.8	4.9		V
		$R_L = 150\Omega$	4.5	4.7		V
I_{SC}	Short Circuit Current	$R_L = 10\Omega$	110	160		mA
POWER SUPPLY PERFORMANCE						
PSRR	Power Supply Rejection Ratio	V_S is moved from $\pm 5.4V$ to $\pm 6.6V$	75	85		dB
$I_{S ON}$	Supply Current Enable (Per Amplifier)	No load		5.8	7	mA
$I_{S OFF}$	Supply Current Disable (Per Amplifier) (EL1516A)	I+ (DIS)		2	5	μA
		I- (DIS)	-19	-16		μA
$TC I_S$	I_S Temperature Coefficient			32		$\mu A/^\circ C$
V_S	Operating Range		5		12	V

Electrical Specifications $V_{S+} = +6V$, $V_{S-} = -6V$, $R_L = 500\Omega$ and $C_L = 3pF$ to $0V$, $R_F = R_G = 620\Omega$, $V_{CM} = 0V$, and $T_A = +25^\circ C$, Unless Otherwise Specified. **(Continued)**

PARAMETER	DESCRIPTION	CONDITIONS	MIN	TYP	MAX	UNIT
DYNAMIC PERFORMANCE						
SR	Slew Rate	$V_O = \pm 2.5V$ square wave, measured 25% to 75%	90	128		V/ μs
TC SR	SR Temperature Coefficient			0.5		V/ $\mu s/^\circ C$
t_S	Settling to 0.1% ($A_V = +2$)	$A_V = +2$, $V_O = \pm 1V$		20		ns
BW1	-3dB Bandwidth	$A_V = -1$, $R_F = 100\Omega$		350		MHz
BW2	-3dB Bandwidth	$A_V = +2$, $R_F = 100\Omega$		250		MHz
HD2	2nd Harmonic Distortion	$f = 1MHz$, $V_O = 2V_{P-P}$, $R_L = 500\Omega$		125		dBc
		$f = 1MHz$, $V_O = 2V_{P-P}$, $R_L = 150\Omega$		117		dBc
HD3	3rd Harmonic Distortion	$f = 1MHz$, $V_O = 2V_{P-P}$, $R_L = 500\Omega$		115		dBc
		$f = 1MHz$, $V_O = 2V_{P-P}$, $R_L = 150\Omega$		110		dBc
ENABLE (EL1516AIY ONLY)						
t_{EN}	Enable Time			125		ns
t_{DIS}	Disable Time			336		ns
I_{IHEN}	\overline{EN} Pin Input High Current	$\overline{EN} = V_{S+}$		17	20	μA
I_{ILEN}	\overline{EN} Pin Input Low Current	$\overline{EN} = V_{S-}$		7	20	nA
V_{IHEN}	\overline{EN} Pin Input High Voltage for Power-down			$V_{S+} - 1$		V
V_{IHEN}	\overline{EN} Pin Input Low Voltage for Power-up			$V_{S-} + 3$		V

Typical Performance Curves

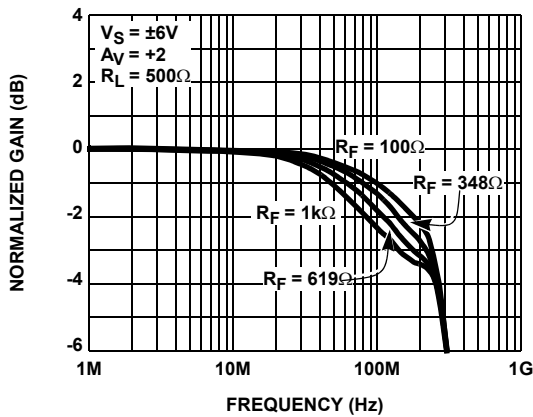

FIGURE 1. NON-INVERTING FREQUENCY RESPONSE FOR VARIOUS R_F

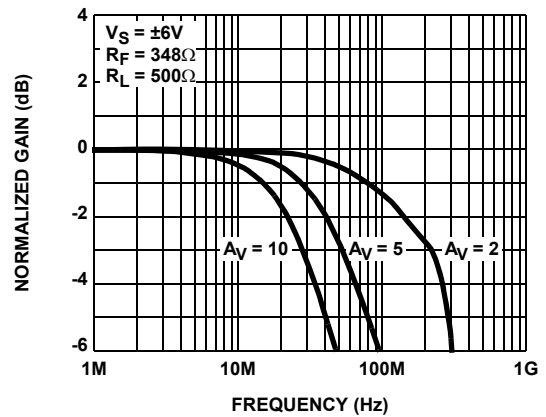

FIGURE 2. NON-INVERTING FREQUENCY RESPONSE (GAIN)

Typical Performance Curves (Continued)

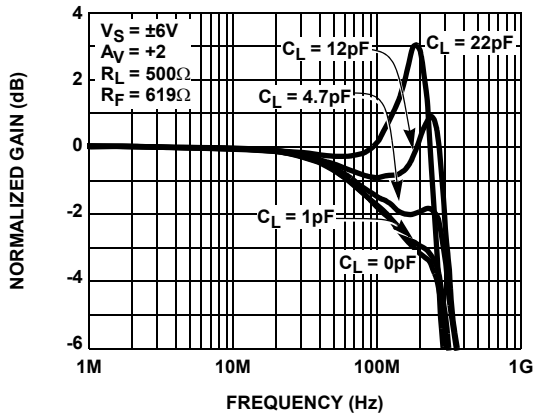

FIGURE 3. NON-INVERTING FREQUENCY RESPONSE FOR VARIOUS C_L

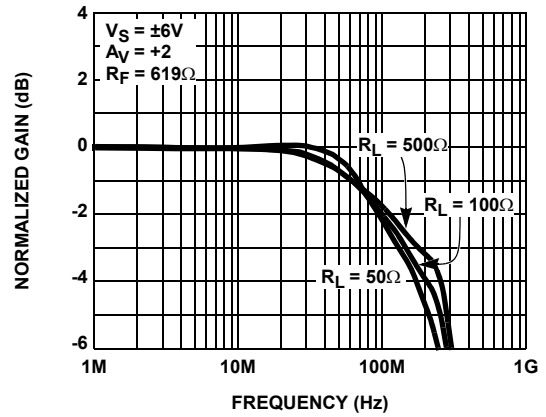

FIGURE 4. NON-INVERTING FREQUENCY RESPONSE FOR VARIOUS R_L

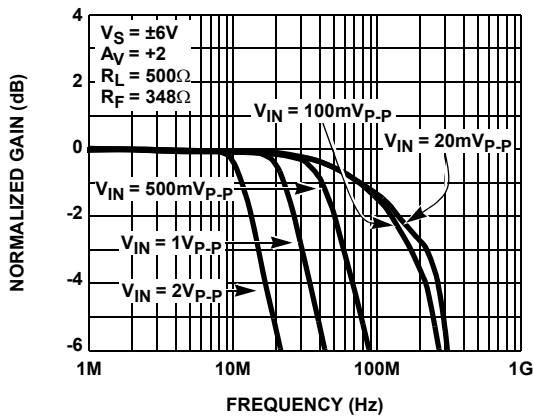

FIGURE 5. NON-INVERTING FREQUENCY RESPONSE FOR VARIOUS INPUT SIGNAL LEVELS

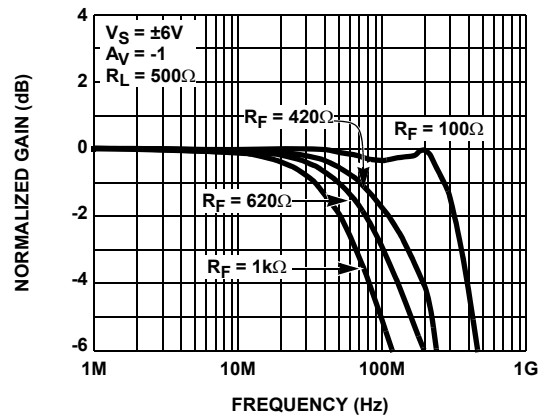

FIGURE 6. INVERTING FREQUENCY RESPONSE FOR VARIOUS R_F

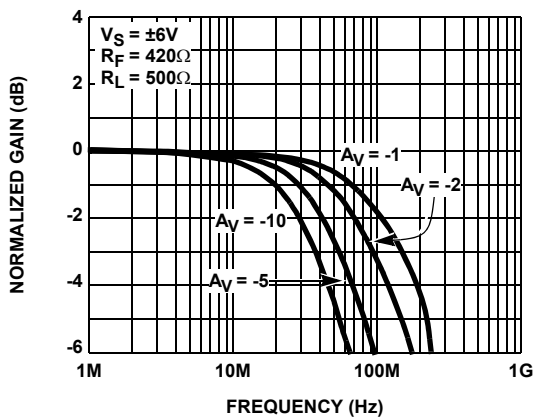

FIGURE 7. INVERTING FREQUENCY RESPONSE (GAIN)

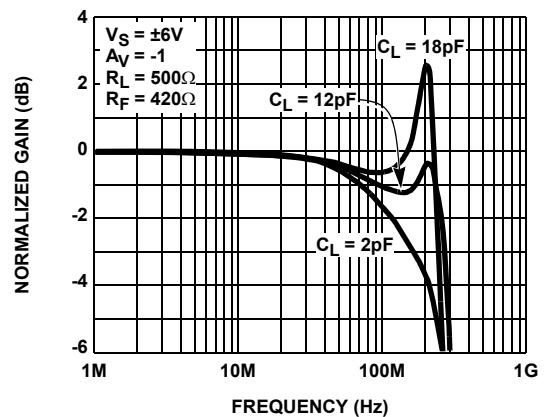

FIGURE 8. INVERTING FREQUENCY RESPONSE FOR VARIOUS C_L

Typical Performance Curves (Continued)

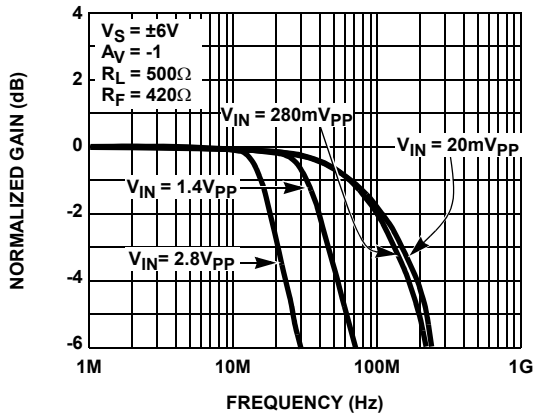

FIGURE 9. INVERTING FREQUENCY RESPONSE FOR VARIOUS SIGNAL LEVELS

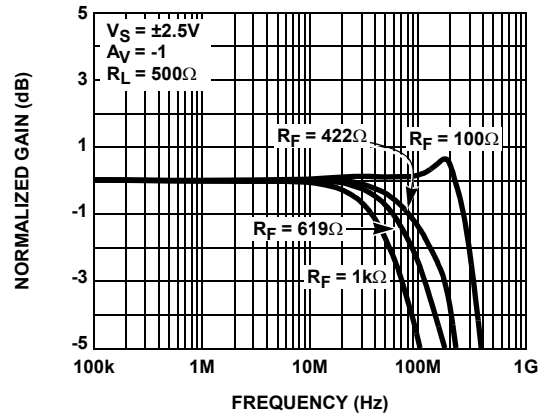

FIGURE 10. INVERTING FREQUENCY RESPONSE FOR VARIOUS R_F

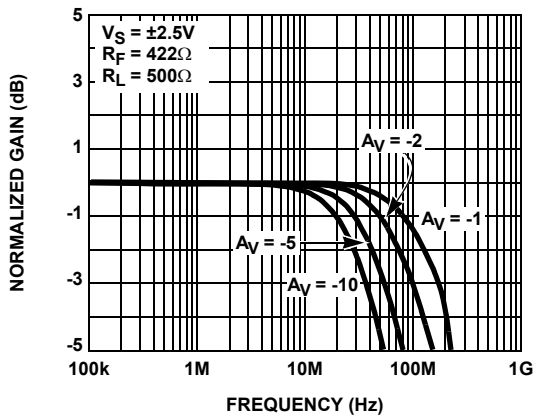

FIGURE 11. INVERTING FREQUENCY RESPONSE FOR VARIOUS A_V

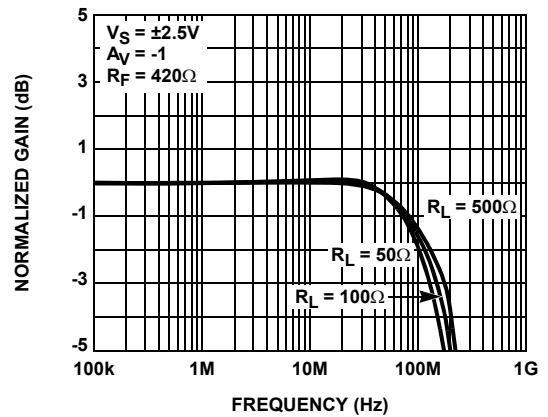

FIGURE 12. INVERTING FREQUENCY RESPONSE FOR VARIOUS R_L

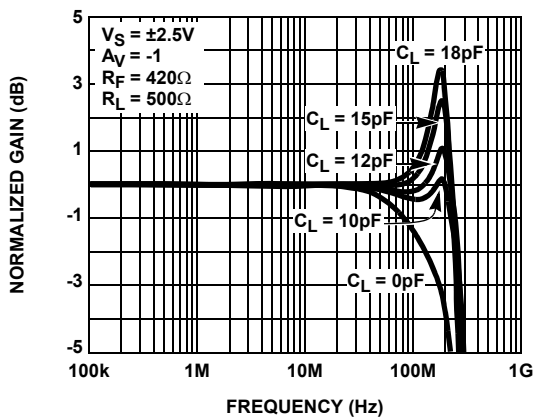

FIGURE 13. INVERTING FREQUENCY RESPONSE FOR VARIOUS C_L

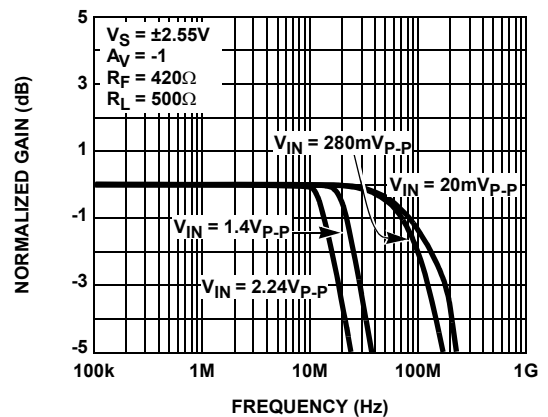

FIGURE 14. INVERTING FREQUENCY RESPONSE FOR VARIOUS INPUT SIGNAL LEVELS

Typical Performance Curves (Continued)

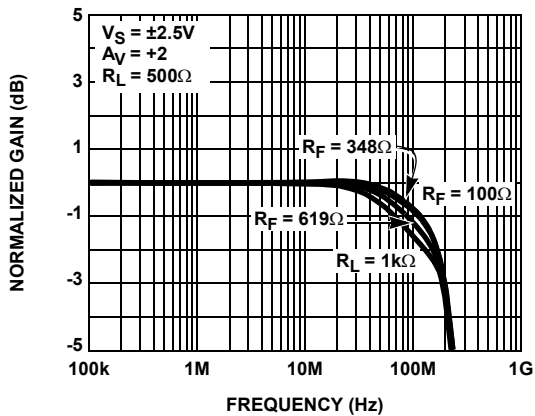

FIGURE 15. NON-INVERTING FREQUENCY RESPONSE FOR VARIOUS R_F

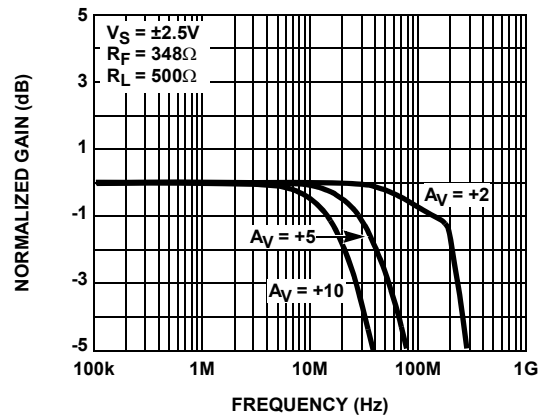

FIGURE 16. NON-INVERTING FREQUENCY RESPONSE FOR VARIOUS A_V

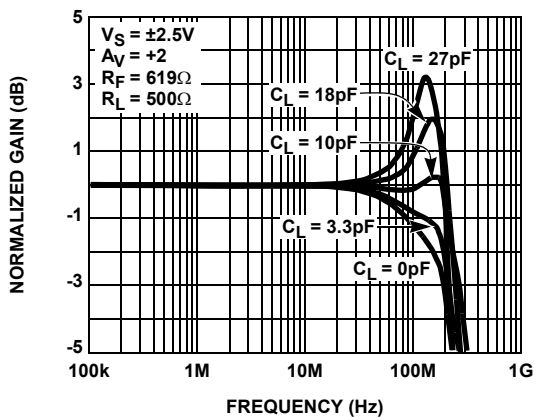

FIGURE 17. NON-INVERTING FREQUENCY RESPONSE FOR VARIOUS C_L

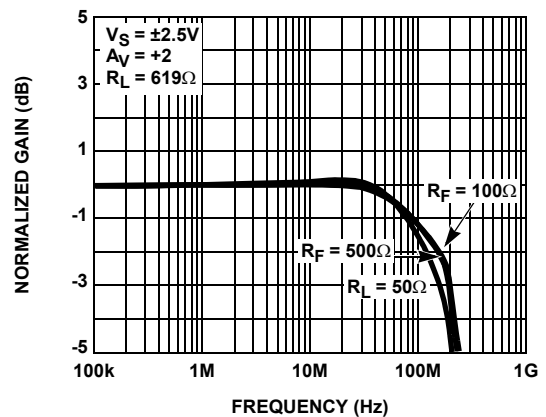

FIGURE 18. NON-INVERTING FREQUENCY RESPONSE FOR VARIOUS R_L

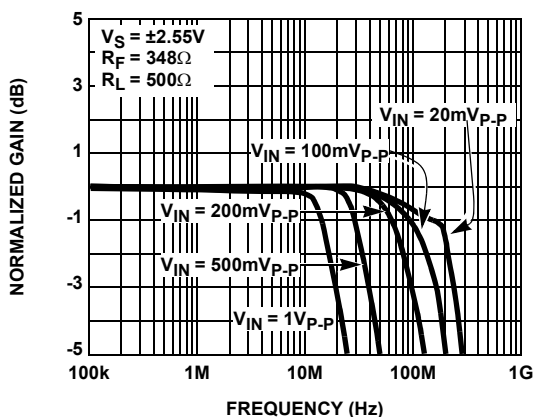

FIGURE 19. NON-INVERTING FREQUENCY RESPONSE FOR VARIOUS INPUT SIGNAL LEVELS

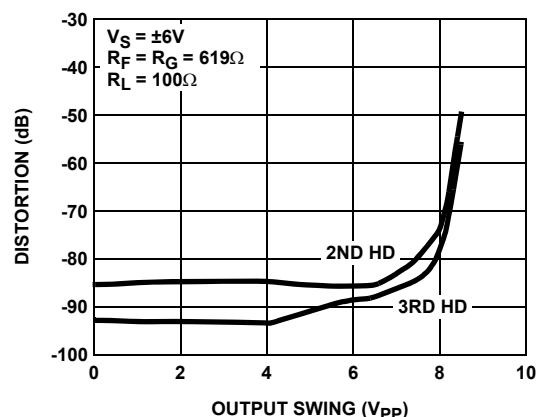

FIGURE 20. 1MHz 2ND AND 3RD HARMONIC DISTORTION vs OUTPUT SWING

Typical Performance Curves (Continued)

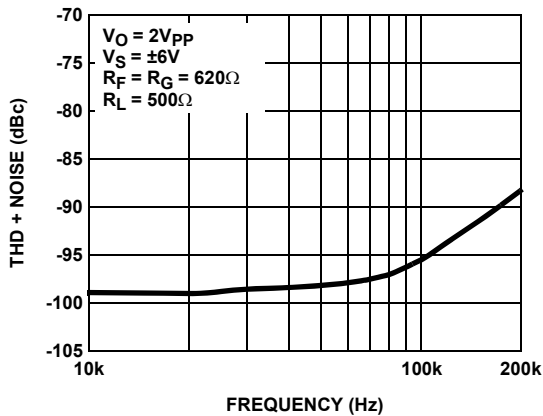

FIGURE 21. THD + NOISE vs FREQUENCY

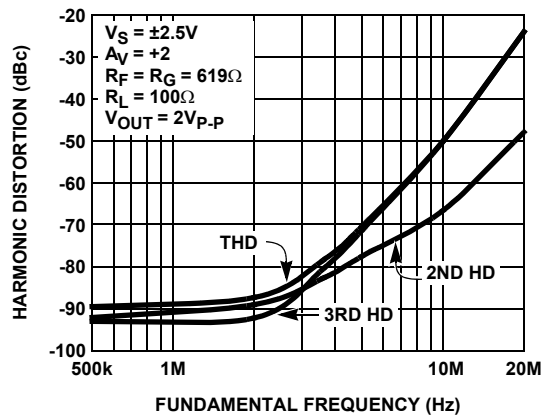

FIGURE 22. HARMONIC DISTORTION vs FREQUENCY

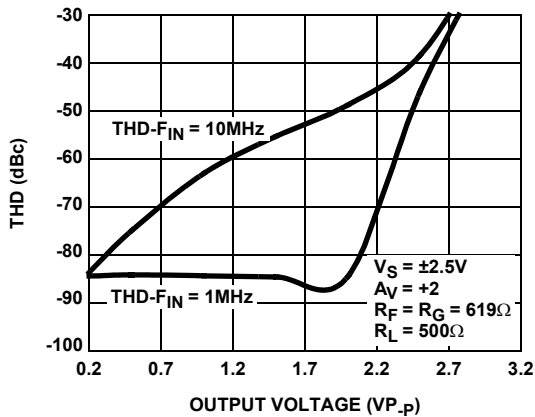

FIGURE 23. THD vs OUTPUT VOLTAGE

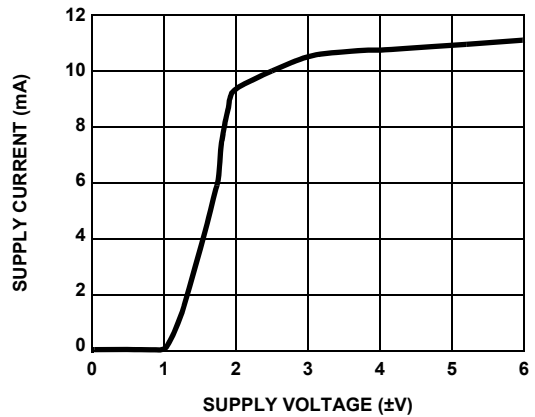

FIGURE 24. SUPPLY CURRENT vs SUPPLY VOLTAGE

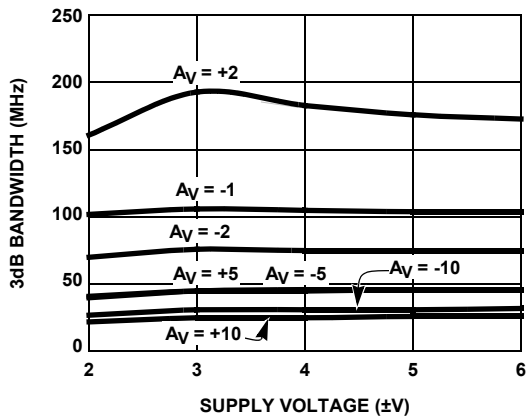

FIGURE 25. 3dB BANDWIDTH vs SUPPLY VOLTAGE

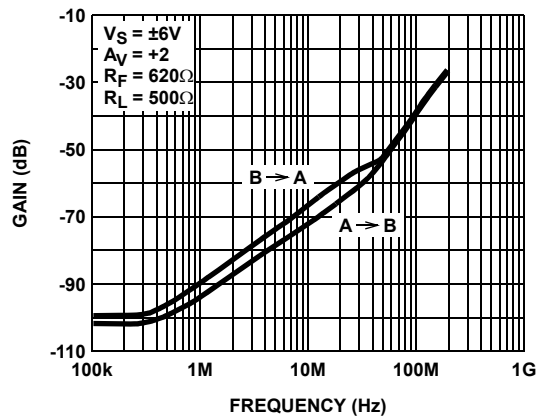

FIGURE 26. CHANNEL-TO-CHANNEL ISOLATION vs FREQUENCY

Typical Performance Curves (Continued)

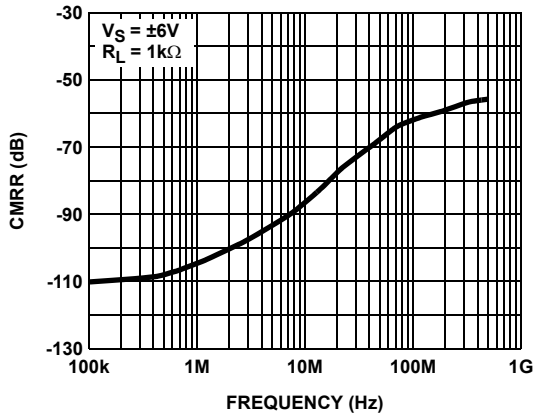

FIGURE 27. CMRR

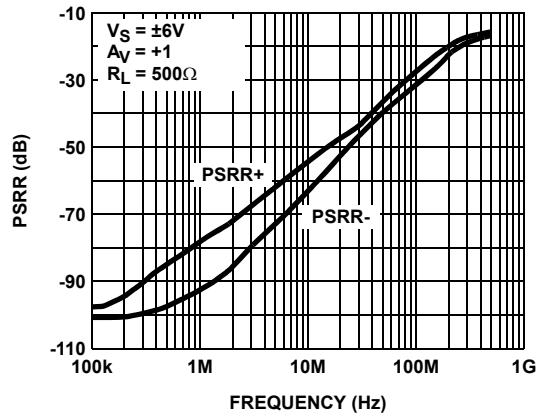

FIGURE 28. PSRR

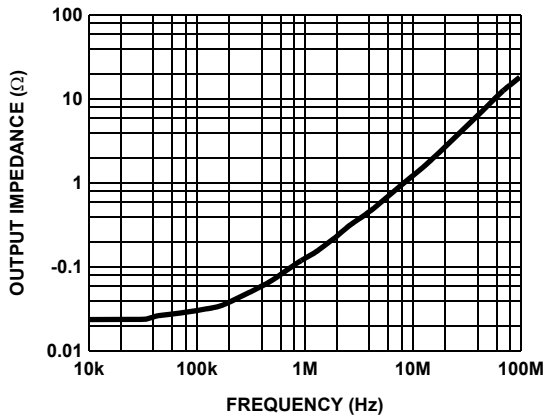

FIGURE 29. CLOSED LOOP OUTPUT IMPEDANCE vs FREQUENCY

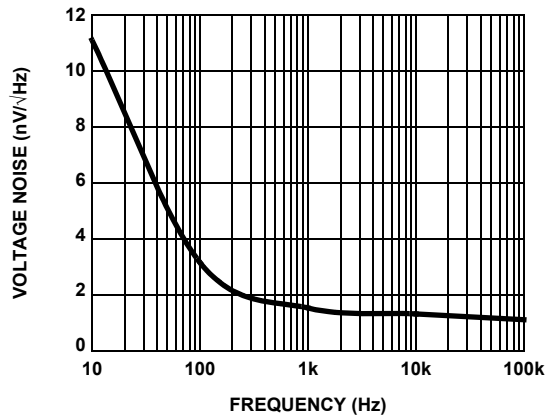

FIGURE 30. VOLTAGE NOISE

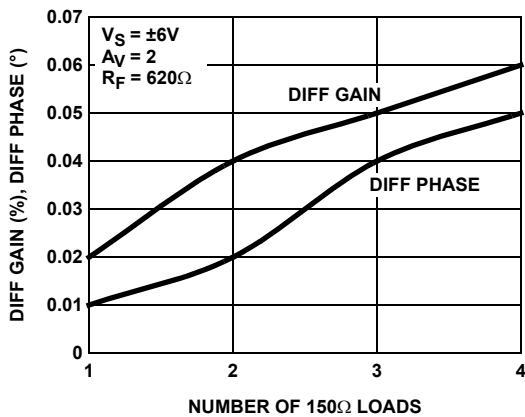

FIGURE 31. DIFFERENTIAL GAIN/PHASE

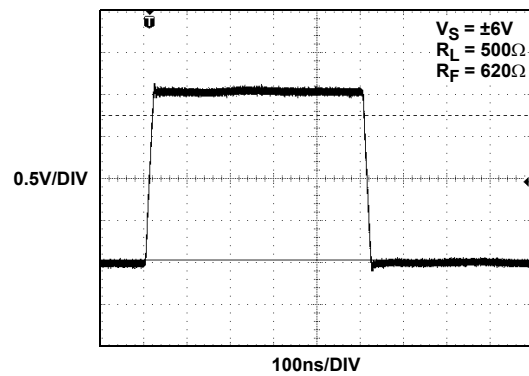

FIGURE 32. LARGE SIGNAL STEP RESPONSE

Typical Performance Curves (Continued)

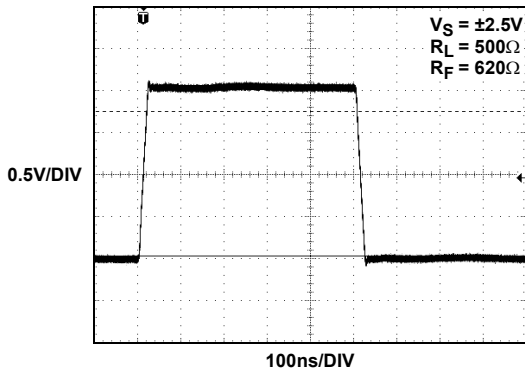

FIGURE 33. LARGE SIGNAL STEP RESPONSE

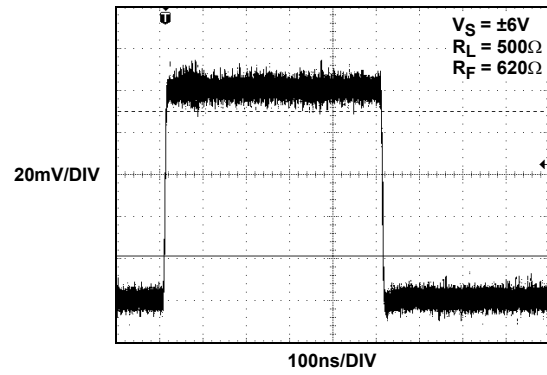

FIGURE 34. SMALL SIGNAL STEP RESPONSE

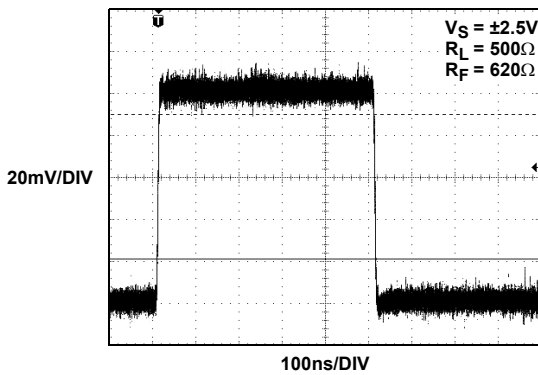

FIGURE 35. SMALL SIGNAL STEP RESPONSE

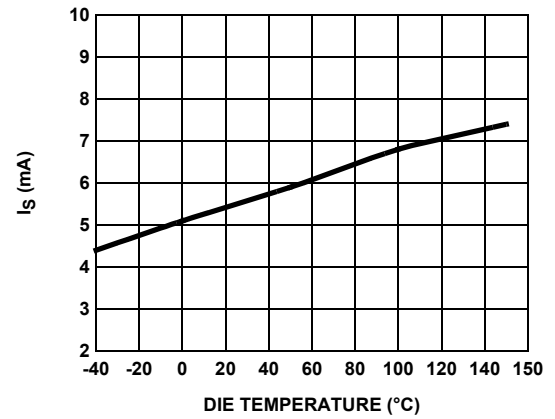

FIGURE 36. SUPPLY CURRENT vs TEMPERATURE

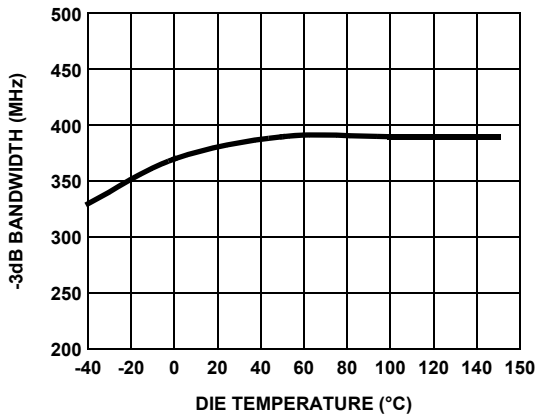

FIGURE 37. -3dB BANDWIDTH vs TEMPERATURE

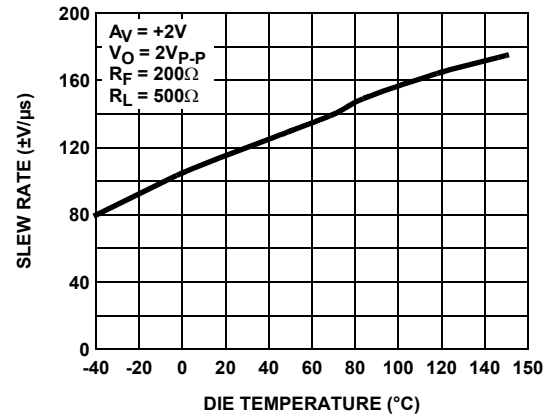

FIGURE 38. SLEW RATE vs TEMPERATURE

Typical Performance Curves (Continued)

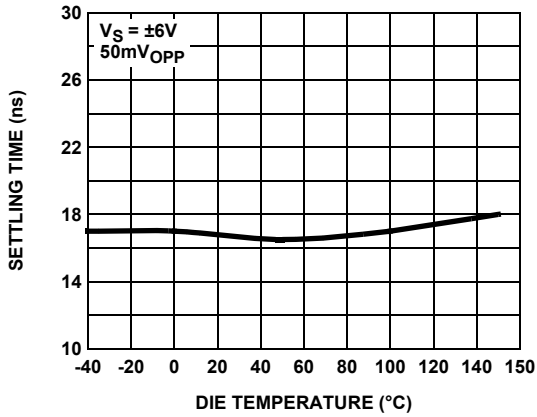

FIGURE 39. 0.1% SETTILING TIME vs TEMPERATURE

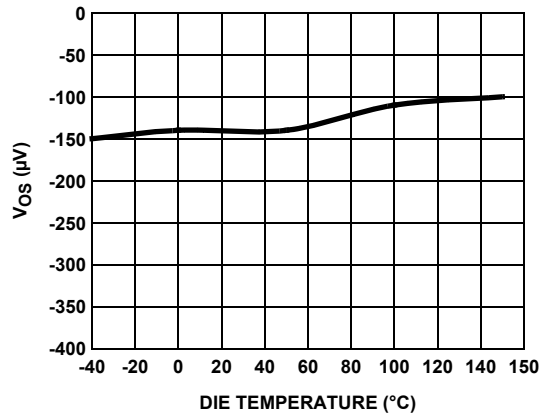

FIGURE 40. V_{OS} vs TEMPERATURE

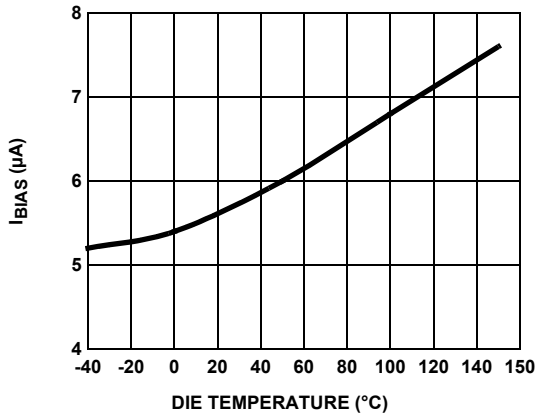

FIGURE 41. I_{BIAS} CURRENT vs TEMPERATURE

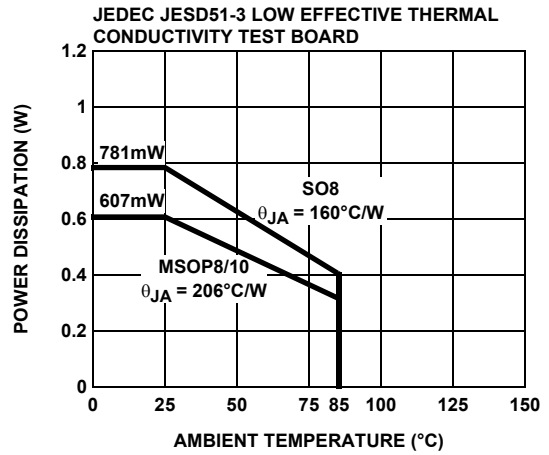

FIGURE 42. PACKAGE POWER DISSIPATION vs AMBIENT TEMPERATURE

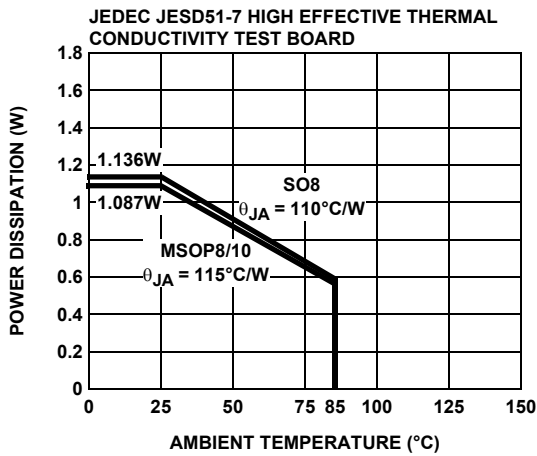
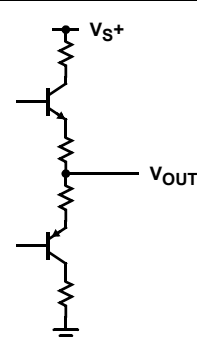
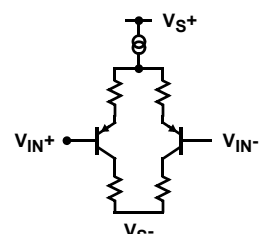
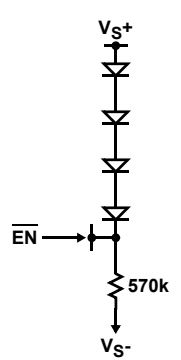

FIGURE 43. PACKAGE POWER DISSIPATION vs AMBIENT TEMPERATURE

Pin Descriptions

EL1516 (8 Ld SOIC AND 8 Ld MSOP)	EL1516A (10 Ld MSOP)	PIN NAME	PIN FUNCTION	EQUIVALENT CIRCUIT
1	9	VOUTA	Output	 <p>CIRCUIT 1</p>
2	10	VINA-	Input	 <p>CIRCUIT 2</p>
3	1	VINA+	Input	Reference Circuit 2
4	3	VS-	Supply	
5	5	VINB+	Input	
6	6	VINB-	Input	Reference Circuit 2
7	7	VOUTB	Output	Reference Circuit 1
8	8	VS+	Supply	
	2, 4	$\overline{\text{ENA}}, \overline{\text{ENB}}$	Enable	 <p>CIRCUIT 3</p>

Applications Information

Product Description

The EL1516 is a dual voltage feedback operational amplifier designed especially for DMT ADSL and other applications requiring very low voltage and current noise. It also features low distortion while drawing moderately low supply current. The EL1516 uses a classical voltage-feedback topology which allows it to be used in a variety of applications where current-feedback amplifiers are not appropriate because of restrictions placed upon the feedback element used with the amplifier. The conventional topology of the EL1516 allows, for example, a capacitor to be placed in the feedback path, making it an excellent choice for applications such as active filters, sample-and-holds, or integrators.

ADSL CPE Applications

The low noise EL1516 amplifier is specifically designed for the dual differential receiver amplifier function with ADSL transceiver hybrids as well as other low-noise amplifier applications. A typical ADSL CPE line interface circuit is shown in Figure 44. The EL1516 is used in receiving DMT down stream signal. With careful transceiver hybrid design and the EL1516 1.4nV/√Hz voltage noise and 1.5pA/√Hz current noise performance, -140dBm/Hz system background noise performance can be easily achieved.

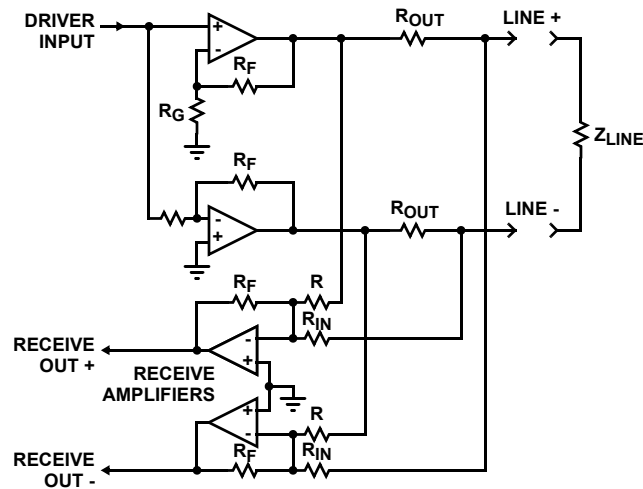

FIGURE 44. TYPICAL LINE INTERFACE CONNECTION

Power Dissipation

With the wide power supply range and large output drive capability of the EL1516, it is possible to exceed the +150°C maximum junction temperatures under certain load and power supply conditions. It is therefore important to calculate the maximum junction temperature (T_{JMAX}) for all applications to determine if power supply voltages, load conditions, or package type need to be modified for the EL1516 to remain in the safe operating area. These parameters are related as follows:

$$T_{JMAX} = T_{MAX} + (\theta_{JA} \times PD_{MAXTOTAL}) \tag{EQ. 1}$$

where:

- $PD_{MAXTOTAL}$ is the sum of the maximum power dissipation of each amplifier in the package (PD_{MAX})
- PD_{MAX} for each amplifier can be calculated as follows:

$$PD_{MAX} = 2 \times V_S \times I_{SMAX} + (V_S - V_{OUTMAX}) \times \frac{V_{OUTMAX}}{R_L} \tag{EQ. 2}$$

where:

- T_{MAX} = Maximum ambient temperature
- θ_{JA} = Thermal resistance of the package
- PD_{MAX} = Maximum power dissipation of 1 amplifier
- V_S = Supply voltage
- I_{MAX} = Maximum supply current of 1 amplifier
- V_{OUTMAX} = Maximum output voltage swing of the application
- R_L = Load resistance

To serve as a guide for the user, we can calculate maximum allowable supply voltages for the example of the video cable-driver below since we know that $T_{JMAX} = +150^\circ\text{C}$, $T_{MAX} = +75^\circ\text{C}$, $I_{SMAX} = 7.7\text{mA}$, and the package θ_{JA} s are shown in Table 1. If we assume (for this example) that we are driving a back-terminated video cable, then the maximum average value (over duty-cycle) of V_{OUTMAX} is 1.4V, and $R_L = 150\Omega$, giving the results seen in Table 1.

TABLE 1.

PART	PACKAGE	θ_{JA}	MAX PDISS @ T_{MAX}	MAX V_S
EL1516IS	SO8	110°C/W	0.406W @ +85°C	
EL1516IY	MSOP8	115°C/W	0.400W @ +85°C	
EL1516AIY	MSOP10	115°C/W	0.400W @ +85°C	

Single-Supply Operation

The EL1516 has been designed to have a wide input and output voltage range. This design also makes the EL1516 an excellent choice for single-supply operation. Using a single positive supply, the lower input voltage range is within 1.2V of ground ($R_L = 500\Omega$), and the lower output voltage range is within 875mV of ground. Upper input voltage range reaches 3.6V, and output voltage range reaches 3.8V with a 5V supply and $R_L = 500\Omega$. This results in a 2.625V output swing on a single 5V supply. This wide output voltage range also allows single-supply operation with a supply voltage as high as 12V.

Gain-Bandwidth Product and the -3dB Bandwidth

The EL1516 has a gain-bandwidth product of 300MHz while using only 6mA of supply current per amplifier. For gains greater than 2, their closed-loop -3dB bandwidth is approximately equal to the gain-bandwidth product divided by the noise gain of the circuit. For gains less than 2, higher-order poles in the amplifiers' transfer function contribute to even higher closed loop bandwidths. For example, the EL1516 has a -3dB bandwidth of 350MHz at a gain of +2, dropping to 80MHz at a gain of +5. It is important to note that the EL1516 has been designed so that this "extra" bandwidth in low-gain applications does not come at the expense of stability. As seen in the typical performance curves, the EL1516 in a gain of +2 only exhibits 0.5dB of peaking with a 1000 Ω load.

Output Drive Capability

The EL1516 has been designed to drive low impedance loads. It can easily drive 6V_{PP} into a 100 Ω load. This high output drive capability makes the EL1516 an ideal choice for RF, IF and video applications.

Printed-Circuit Layout

The EL1516 is well behaved, and easy to apply in most applications. However, a few simple techniques will help assure rapid, high quality results. As with any high-frequency device, good PCB layout is necessary for optimum performance. Ground-plane construction is highly recommended, as is good power supply bypassing. A 0.1 μ F ceramic capacitor is recommended for bypassing both supplies. Lead lengths should be as short as possible, and bypass capacitors should be as close to the device pins as possible. For good AC performance, parasitic capacitances should be kept to a minimum at both inputs and at the output. Resistor values should be kept under 5k Ω because of the RC time constants associated with the parasitic capacitance. Metal-film and carbon resistors are both acceptable, use of wire-wound resistors is not recommended because of their parasitic inductance. Similarly, capacitors should be low-inductance for best performance.

Small Outline Package Family (SO)

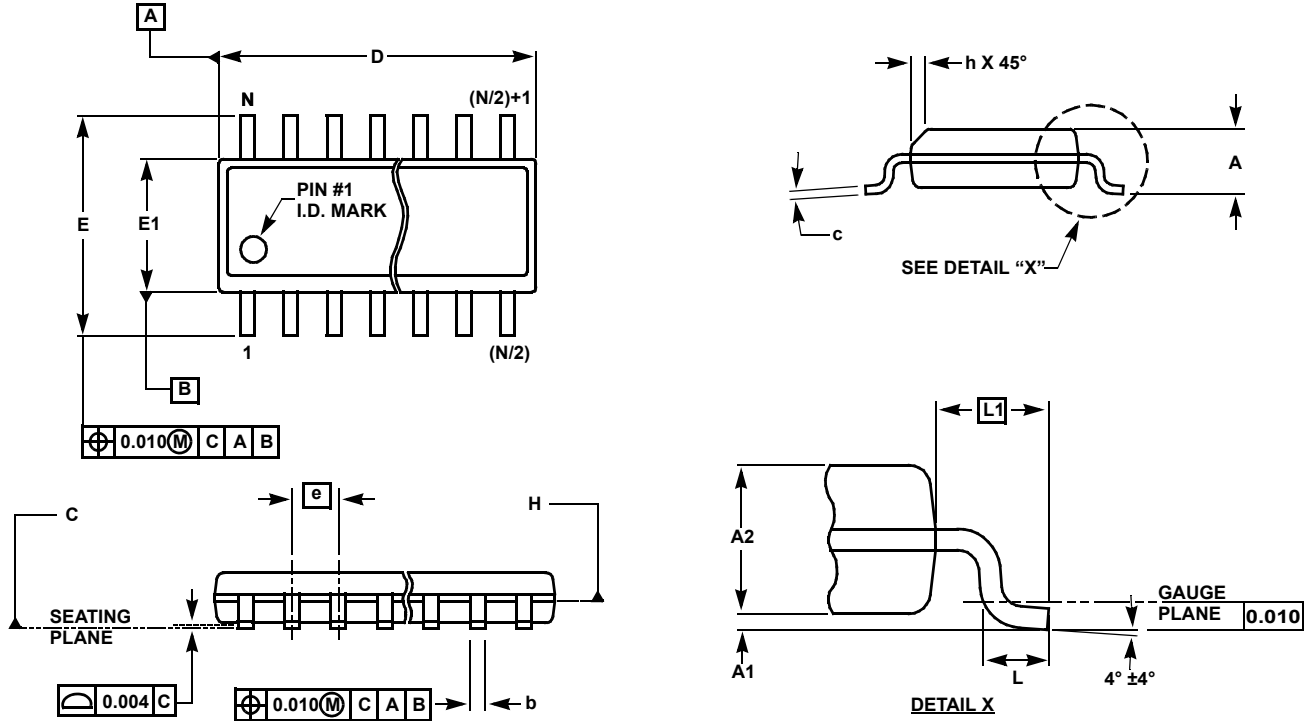

MDP0027

SMALL OUTLINE PACKAGE FAMILY (SO)

SYMBOL	INCHES							TOLERANCE	NOTES
	SO-8	SO-14	SO16 (0.150")	SO16 (0.300") (SOL-16)	SO20 (SOL-20)	SO24 (SOL-24)	SO28 (SOL-28)		
A	0.068	0.068	0.068	0.104	0.104	0.104	0.104	MAX	-
A1	0.006	0.006	0.006	0.007	0.007	0.007	0.007	±0.003	-
A2	0.057	0.057	0.057	0.092	0.092	0.092	0.092	±0.002	-
b	0.017	0.017	0.017	0.017	0.017	0.017	0.017	±0.003	-
c	0.009	0.009	0.009	0.011	0.011	0.011	0.011	±0.001	-
D	0.193	0.341	0.390	0.406	0.504	0.606	0.704	±0.004	1, 3
E	0.236	0.236	0.236	0.406	0.406	0.406	0.406	±0.008	-
E1	0.154	0.154	0.154	0.295	0.295	0.295	0.295	±0.004	2, 3
e	0.050	0.050	0.050	0.050	0.050	0.050	0.050	Basic	-
L	0.025	0.025	0.025	0.030	0.030	0.030	0.030	±0.009	-
L1	0.041	0.041	0.041	0.056	0.056	0.056	0.056	Basic	-
h	0.013	0.013	0.013	0.020	0.020	0.020	0.020	Reference	-
N	8	14	16	16	20	24	28	Reference	-

Rev. M 2/07

NOTES:

1. Plastic or metal protrusions of 0.006" maximum per side are not included.
2. Plastic interlead protrusions of 0.010" maximum per side are not included.
3. Dimensions "D" and "E1" are measured at Datum Plane "H".
4. Dimensioning and tolerancing per ASME Y14.5M-1994

Mini SO Package Family (MSOP)

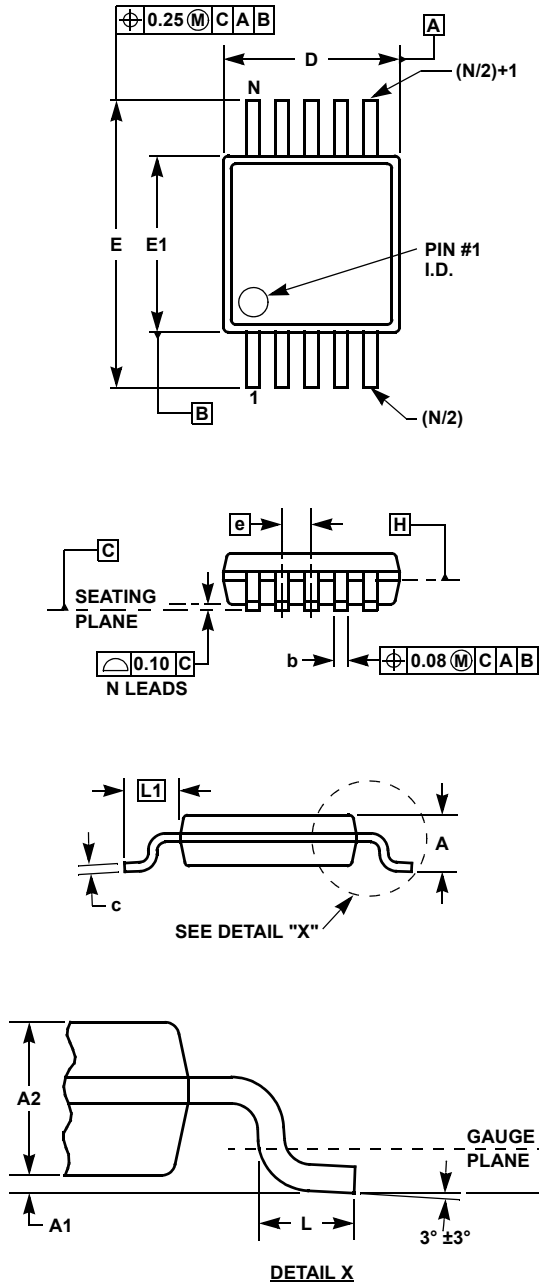

MDP0043 MINI SO PACKAGE FAMILY

SYMBOL	MILLIMETERS		TOLERANCE	NOTES
	MSOP8	MSOP10		
A	1.10	1.10	Max.	-
A1	0.10	0.10	±0.05	-
A2	0.86	0.86	±0.09	-
b	0.33	0.23	+0.07/-0.08	-
c	0.18	0.18	±0.05	-
D	3.00	3.00	±0.10	1, 3
E	4.90	4.90	±0.15	-
E1	3.00	3.00	±0.10	2, 3
e	0.65	0.50	Basic	-
L	0.55	0.55	±0.15	-
L1	0.95	0.95	Basic	-
N	8	10	Reference	-

Rev. D 2/07

NOTES:

1. Plastic or metal protrusions of 0.15mm maximum per side are not included.
2. Plastic interlead protrusions of 0.25mm maximum per side are not included.
3. Dimensions "D" and "E1" are measured at Datum Plane "H".
4. Dimensioning and tolerancing per ASME Y14.5M-1994.

© Copyright Intersil Americas LLC 2005-2007. All Rights Reserved.
All trademarks and registered trademarks are the property of their respective owners.

For additional products, see www.intersil.com/en/products.html

Intersil products are manufactured, assembled and tested utilizing ISO9001 quality systems as noted in the quality certifications found at www.intersil.com/en/support/qualandreliability.html

Intersil products are sold by description only. Intersil may modify the circuit design and/or specifications of products at any time without notice, provided that such modification does not, in Intersil's sole judgment, affect the form, fit or function of the product. Accordingly, the reader is cautioned to verify that datasheets are current before placing orders. Information furnished by Intersil is believed to be accurate and reliable. However, no responsibility is assumed by Intersil or its subsidiaries for its use; nor for any infringements of patents or other rights of third parties which may result from its use. No license is granted by implication or otherwise under any patent or patent rights of Intersil or its subsidiaries.

For information regarding Intersil Corporation and its products, see www.intersil.com