

For New Design Applications Contact Elantec's Sales Office

Features

- Low offset voltage—0.5 mV typ., 2 mV max
- Low supply current—13 mA typ., 17 mA max
- High slew rate—
EL2039—600 V/ μ s
EL2040—400 V/ μ s
- Large open loop gain—15 kV/V (83 dB)
- Wide gain-bandwidth—
EL2039—600 MHz
EL2040—400 MHz
- High power bandwidth—
EL2039—9.5 MHz
EL2040—6.3 MHz
- Output voltage swing— \pm 11V
- MIL-STD-883 Rev. C compliant
- Improved replacements for HA2539 and HA2540

Applications

- Pulse and video amplifiers
- Wideband amplifiers
- High speed sample-hold circuits
- Local area networks

Ordering Information

| Part No. | Temp. Range | Package | Outline # |
|----------|--------------|--------------|-----------|
| EL2039CN | 0°C to +75°C | 14-Pin P-DIP | MDP0031 |
| EL2040CN | 0°C to +75°C | 14-Pin P-DIP | MDP0031 |

General Description

The EL2039 and EL2040 monolithic operational amplifiers are pin compatible with the HA2539 and HA2540, but have patented circuitry for improved dynamic performance and DC accuracy, and a typical power reduction of 35%. Additionally, these Elantec amplifiers are stable when driving capacitive loads and are well behaved when the output is overdriven. Both devices are compensated for closed loop gains \geq 10. The EL2039 is the fastest of the series with a 600 V/ μ s slew rate and 600 MHz gain-bandwidth product. The EL2040 has a 400 V/ μ s slew rate and 400 MHz gain-bandwidth product. The EL2039 and EL2040 are fabricated with Elantec's Complementary Bipolar process and are zener zap trimmed for low offset voltage.

Elantec's high speed amplifiers are widely used in military, video and medical applications. They are especially suited for high speed video amplifiers, pulse detectors, and wide bandwidth filters.

Elantec's EL2039C and EL2040C comply with MIL-I-45208A and other applicable quality specifications. For information on Elantec's processing, see the Elantec document, QRA-1: *Elantec's Processing—Monolithic Products.*

Connection Diagrams

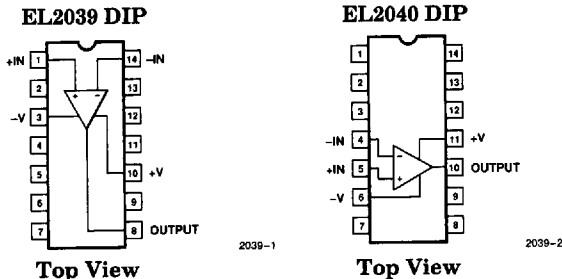

Note: Non-designated pins are no connects and are not electrically connected internally.

Manufactured under U.S. Patent No. 4,837,523

EL2039C/EL2040C

Very High Slew Rate Wideband Operational Amplifier

EL2039C/EL2040C

Absolute Maximum Ratings ($T_A = 25^\circ\text{C}$)

| | | | | | |
|------------|-------------------------------|--------------|----------|--|-----------------|
| V_S | Voltage between $V+$ and $V-$ | 35V | T_J | Operating Junction Temperature | 150°C |
| V_{DIFF} | Differential Input Voltage | 6V | T_{ST} | Storage Temperature | -65°C to +150°C |
| I_{OP} | Output Current, Peak | 50 mA | T_{LT} | Lead Temperature (Soldering, 5 seconds) | 300°C |
| I_{OC} | Output Current, Continuous | 25 mA | | | |
| P_D | Internal Power Dissipation | See Curves | | | |
| T_A | Operating Temperature Range | 0°C to +75°C | | | |

Important Note:

All parameters having Min/Max specifications are guaranteed. The Test Level column indicates the specific device testing actually performed during production and Quality inspection. Elantec performs most electrical tests using modern high-speed automatic test equipment, specifically the LTX77 Series system. Unless otherwise noted, all tests are pulsed tests, therefore $T_J = T_C = T_A$.

| Test Level | Test Procedure |
|------------|---|
| I | 100% production tested and QA sample tested per QA test plan QCX0002. |
| II | 100% production tested at $T_A = 25^\circ\text{C}$ and QA sample tested at $T_A = 25^\circ\text{C}$, T_{MAX} and T_{MIN} per QA test plan QCX0002. |
| III | QA sample tested per QA test plan QCX0002. |
| IV | Parameter is guaranteed (but not tested) by Design and Characterization Data. |
| V | Parameter is typical value at $T_A = 25^\circ\text{C}$ for information purposes only. |

DC Electrical Characteristics $V_S = \pm 15\text{V}$; $R_L = 1\text{ k}\Omega$, unless otherwise specified

| Parameter | Description | Temp | Min | Typ | Max | Test Level | Units |
|------------|---|------|----------|----------|-----|------------|------------------------------|
| V_{OS} | Input Offset Voltage | 25°C | | 0.5 | 2 | I | mV |
| | | Full | | | 6 | III | mV |
| TCV_{OS} | Average Offset Voltage Drift | Full | | 20 | | V | $\mu\text{V}/^\circ\text{C}$ |
| I_B | Bias Current | 25°C | | 5 | 15 | I | μA |
| | | Full | | | 20 | III | μA |
| I_{OS} | Offset Current | 25°C | | 1 | 4 | I | μA |
| | | Full | | | 6 | III | μA |
| R_{IN} | Input Resistance | 25°C | | 10 | | V | k Ω |
| C_{IN} | Input Capacitance | 25°C | | 1 | | V | pF |
| V_{CM} | Common Mode Range | Full | ± 11 | ± 12 | | II | V |
| e_{IN} | Input Noise Voltage ($f = 1\text{ kHz}$, $R_G = 0\Omega$) | 25°C | | 6 | | V | $\text{nV}/\sqrt{\text{Hz}}$ |
| A_{VOL} | Large Signal Voltage Gain (Note 1) | 25°C | 10k | 15k | | I | V/V |
| | | Full | 5k | | | III | V/V |
| $CMRR$ | Common-Mode Rejection Ratio (Note 2) | Full | 60 | 90 | | II | dB |
| V_O | Output Voltage Swing | Full | ± 11 | ± 12 | | II | V |
| I_O | Output Current (Note 11) | Full | ± 25 | ± 50 | | II | mA |
| R_O | Output Resistance | 25°C | | 30 | | V | Ω |
| I_S | Supply Current | Full | | 13 | 17 | II | mA |
| $PSRR$ | Power-Supply Rejection Ratio (Note 7) | Full | 60 | 85 | | II | dB |

EL2039C/EL2040C

Very High Slew Rate Wideband Operational Amplifier

AC Electrical Characteristics—EL2039

| Parameter | Description | Temp | Min | Typ | Max | Test Level | Units |
|-----------|--|------|-----|-----|-----|------------|------------|
| GBW | Gain-Bandwidth Product (Notes 3, 4) | 25°C | | 600 | | V | MHz |
| FPBW | Full-Power Bandwidth (Notes 1, 5, 8) | 25°C | 8.7 | 9.5 | | I | MHz |
| t_r | Rise Time (Note 6) | 25°C | | 4 | | V | ns |
| OS | Overshoot (Note 6) | 25°C | | 35 | | V | % |
| SR | Slew Rate (Note 6) | 25°C | 550 | 600 | | I | V/ μ s |
| t_s | Settling Time (Note 6) 10V Step to 0.1% | 25°C | | 100 | | V | ns |

AC Electrical Characteristics—EL2040

| Parameter | Description | Temp | Min | Typ | Max | Test Level | Units |
|-----------|---|------|-----|-----|-----|------------|------------|
| GBW | Gain-Bandwidth Product (Notes 3, 4) | 25°C | | 400 | | V | MHz |
| FPBW | Full-Power Bandwidth (Notes 1, 5, 8) | 25°C | 5.5 | 6 | | I | MHz |
| t_r | Rise Time (Note 6) | 25°C | | 5 | | V | ns |
| OS | Overshoot (Note 6) | 25°C | | 15 | | V | % |
| SR | Slew Rate (Note 6) | 25°C | 350 | 400 | | I | V/ μ s |
| t_s | Settling Time (Notes 9, 10) 10V Step to 0.1% | 25°C | | 70 | | V | ns |

Note 1: $V_O = \pm 10V$.

Note 2: Two tests are performed, $V_{CM} = 0V$ to $+10V$ and $V_{CM} = 0V$ to $-10V$.

Note 3: $V_O = 90$ mV.

Note 4: $A_V = 10$.

Note 5: Full Power Bandwidth guaranteed based on slew rate measurement using: $FPBW = \frac{\text{Slew Rate}}{2\pi V_{\text{peak}}}$.

Note 6: Refer to Test Circuits section of data sheet.

Note 7: Two tests are performed. $V_+ = +15V$, and V_- is changed from $-5V$ to $-15V$. $V_- = -15V$, and V_+ is changed from $+5V$ to $+15V$.

Note 8: $R_L = 1$ k Ω .

Note 9: Settling time measurements are made with techniques in the following reference: "Take The Guesswork Out of Settling-Time Measurements," EDN, September 19, 1985.

Note 10: $A_V = -10$, $R_L = 1$ k.

Note 11: $R_L = 200\Omega$.

EL2039C/EL2040C

Very High Slew Rate Wideband Operational Amplifier

EL2039C/EL2040C

EL2039/EL2040 Typical DC Performance Curves

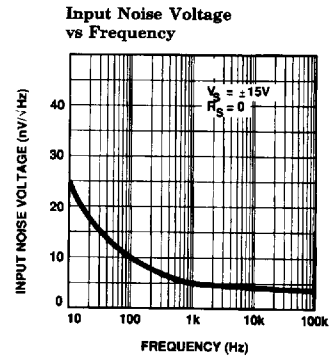
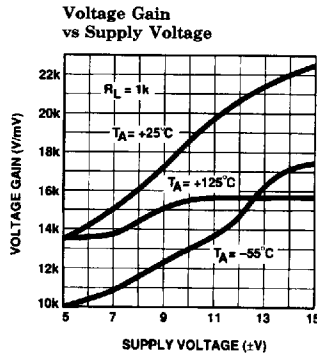
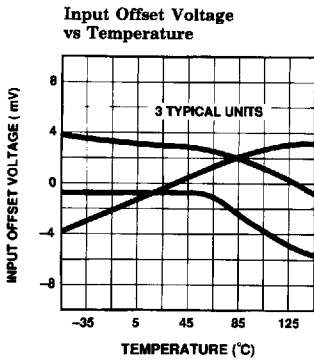
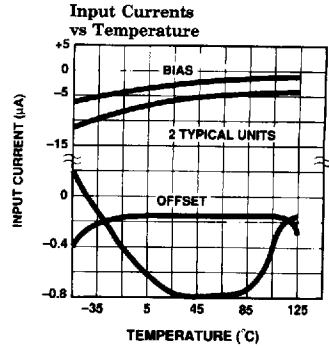
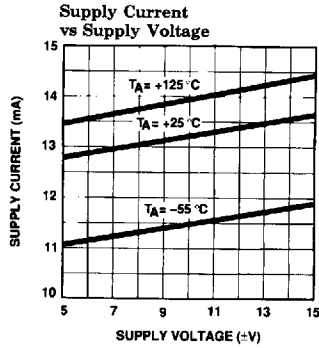
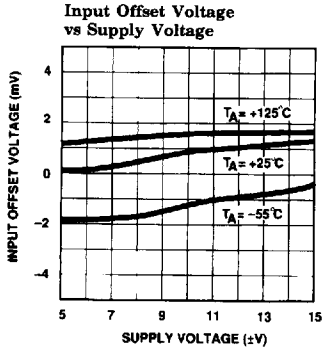

14-Lead Plastic DIP Maximum Power Dissipation vs Ambient Temperature

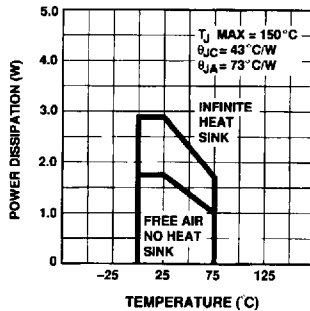

2039-5

EL2039C/EL2040C

Very High Slew Rate Wideband Operational Amplifier

EL2039 Typical AC Performance Curves

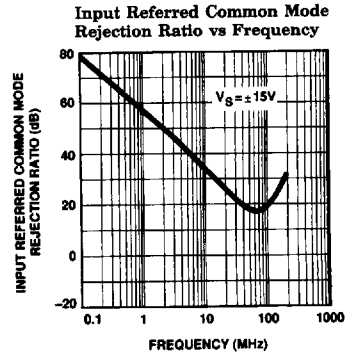
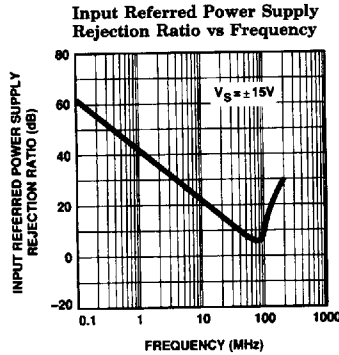
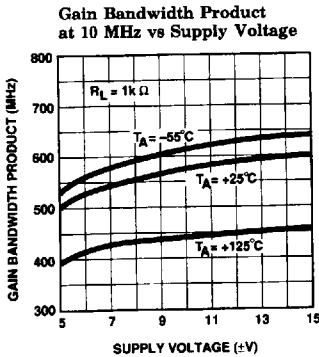
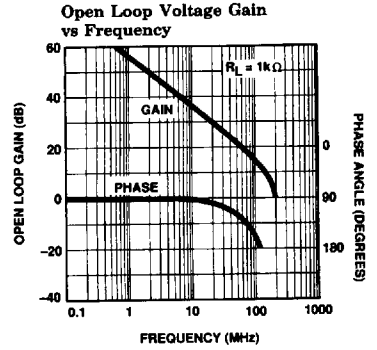
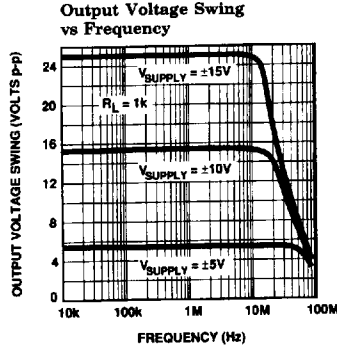
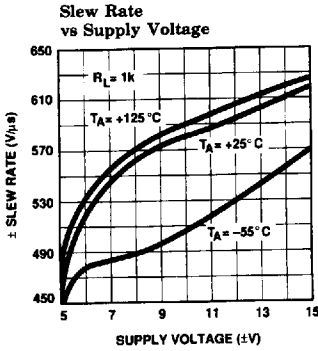

2039-6

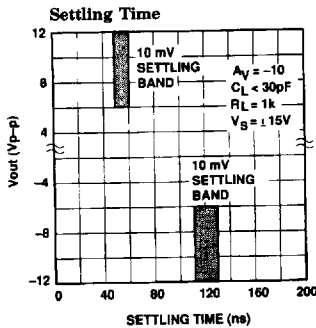

2039-7

Large Signal Response

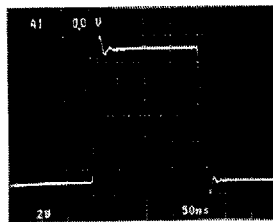

$V_{IN} = \pm 0.5V$
 $V_O = \pm 5V$

2039-8

Small Signal Response

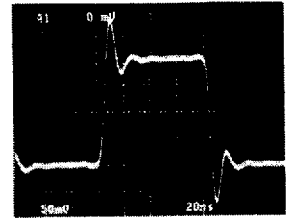

$V_{IN} = \pm 10 mV$
 $V_O = \pm 100 mV$

2039-9

EL2039C/EL2040C

Very High Slew Rate Wideband Operational Amplifier

EL2039C/EL2040C

EL2039 Typical AC Performance Curves — Contd.

HA2539 at Onset of Clipping

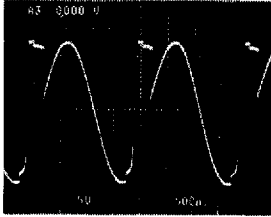

2039-10

EL2039 at Onset of Clipping

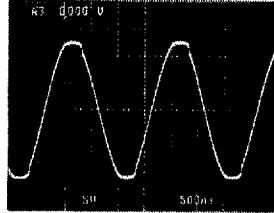

2039-11

EL2040 Typical AC Performance Curves

1

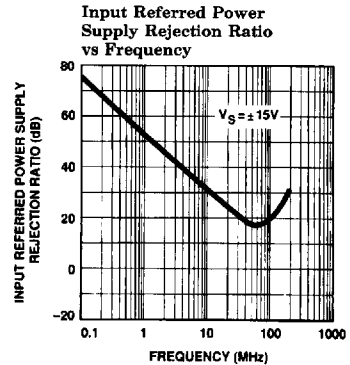
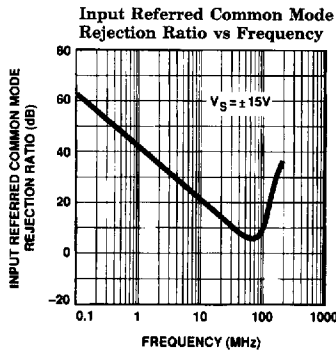
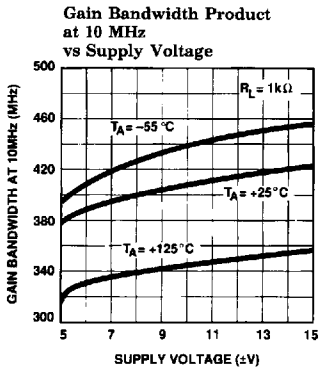
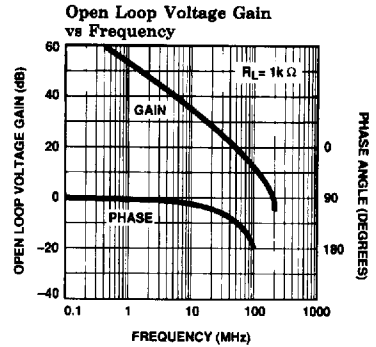
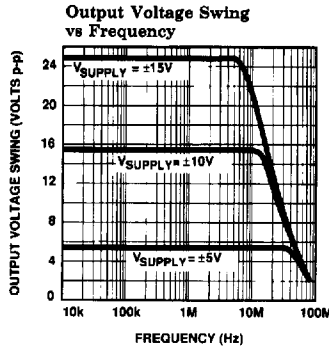
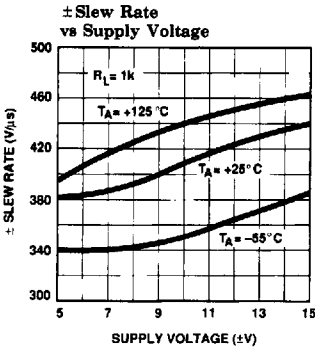

2039-12

EL2039C/EL2040C

Very High Slew Rate Wideband Operational Amplifier

EL2040 Typical AC Performance Curves — Contd.

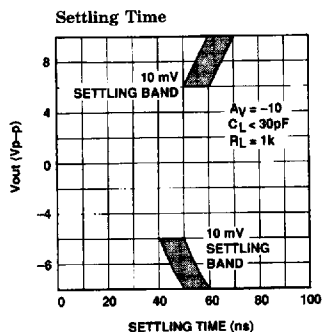

2039-13

Large Signal Response

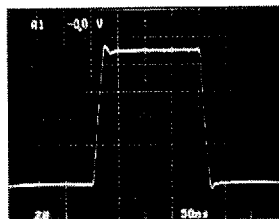

2039-14

Small Signal Response

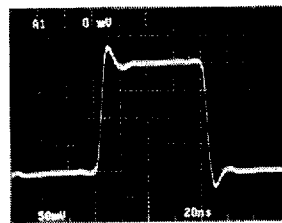

2039-15

Test Circuit

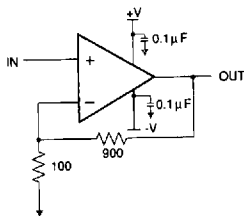

$A_v = 10$
 $C_L = 10\text{ pF}$ Scope Probe

2039-16

Burn-In Circuit

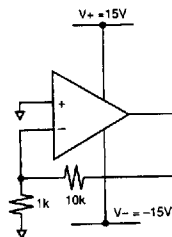

2039-17

EL2039C/EL2040C

Very High Slew Rate Wideband Operational Amplifier

EL2039C/EL2040C

Schematic

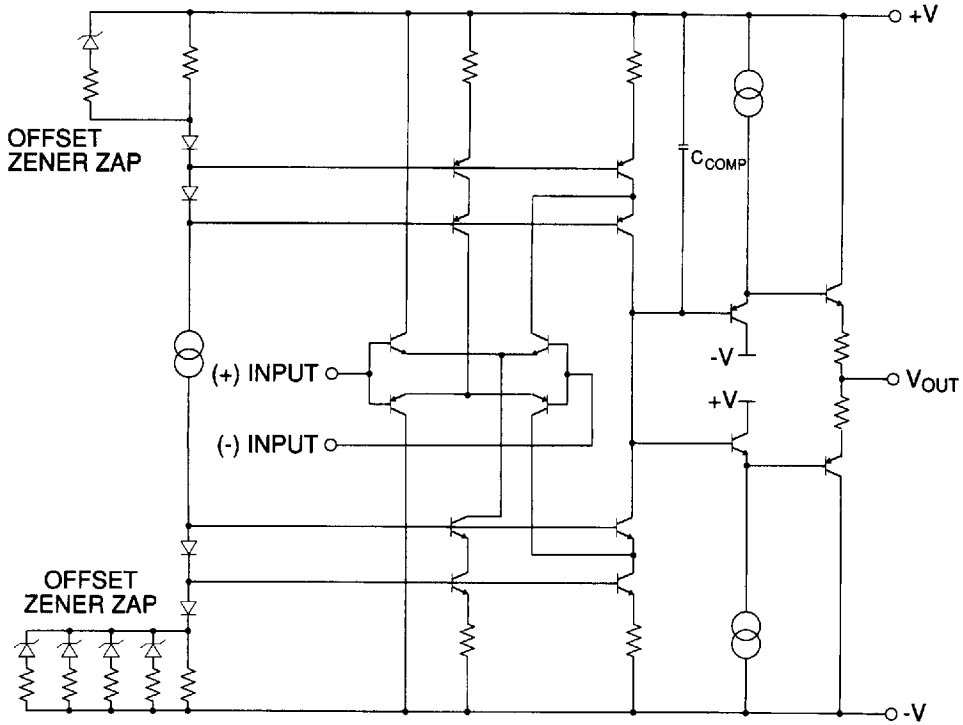

2039-16

1

EL2039C/EL2040C

Very High Slew Rate Wideband Operational Amplifier

EL2039 Macromodel

```

* Connections:
*
*
*
*
*
*
+ input
|
- input
|
+ Vsupply
|
- Vsupply
|
output
|
*
*
.subckt M2039 1 14 10 3 8

```

* Input Stage

```

ie 37 3 1.7mA
r6 36 37 60
r7 38 37 60
rc1 10 30 75
rc2 10 39 75
q1 30 1 36 qn
q2 39 14 38 qna
ediff 33 0 39 30 7.25
rdiff 33 0 1Meg

```

* Compensation Section

```

ga 0 34 33 0 5.2m
rh 34 0 .525Meg
ch 34 0 1.5pF
rc 34 40 600
cc 40 0 7pF

```

* Poles

```

ep 41 0 40 0 1
rpa 41 42 75
cpa 42 0 7pF
rpb 42 43 50
cpb 43 0 3pF

```

* Output Stage

```

ios1 10 50 1.25mA
ios2 51 3 1.25mA
q3 3 43 50 qp
q4 10 43 51 qn
q5 10 50 52 qn
q6 3 51 53 qp
ros1 52 8 25
ros2 8 53 25

```

* Power Supply Current

```

ips 10 3 9.5mA

```

* Models

```

.model qn npn(is=800.0E-18 bf=170 tf=0.2nS)
.model qna npn(is=864E-18 bf=200 tf=0.2nS)
.model qp pnp(is=800E-18 bf=60 tf=0.2nS)
.ends

```

EL2039C/EL2040C

Very High Slew Rate Wideband Operational Amplifier

EL2039C/EL2040C

EL2039 Macromodel — Contd.

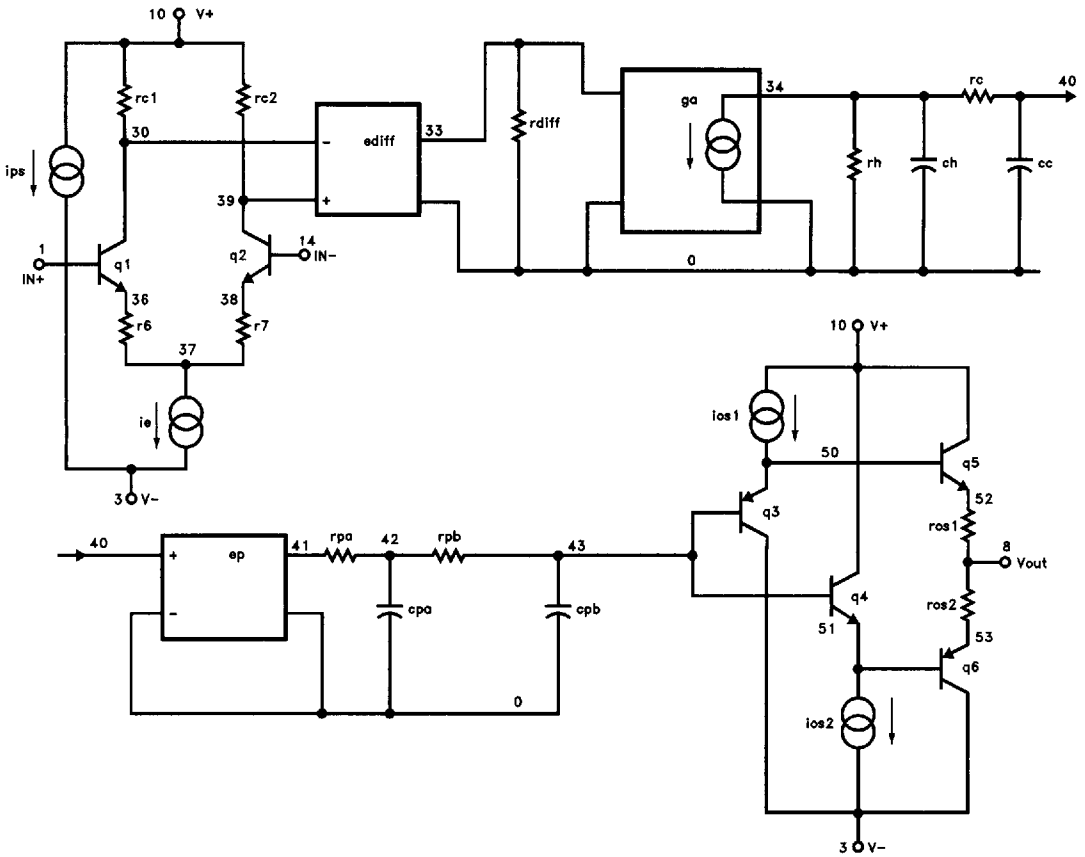

2039-19

EL2039C/EL2040C

Very High Slew Rate Wideband Operational Amplifier

EL2040 Macromodel

```

* Connections:      + input
*                  |
*                  | - input
*                  |
*                  | + Vsupply
*                  | - Vsupply
*                  |
*                  | output
*                  |
.subckt M2040      5  4  11  6  10
* Input Stage
ie 37 6 1.3mA
r6 36 37 60
r7 38 37 60
rc1 11 30 75
rc2 11 39 75
q1 30 5 36 qn
q2 39 4 38 qna
ediff 33 0 39 30 7.25
rdiff 33 0 1Meg
* Compensation Section
ga 0 34 33 0 5.2m
rh 34 0 .525Meg
ch 34 0 1.5pF
rc 34 40 600
cc 40 0 7pF
* Poles
ep 41 0 40 0 1
rpa 41 42 75
cpa 42 0 7pF
rpb 42 43 50
cpb 43 0 3pF
* Output Stage
ios1 11 50 1.25mA
ios2 51 6 1.25mA
q3 6 43 50 qp
q4 11 43 51 qn
q5 11 50 52 qn
q6 6 51 53 qp
ros1 52 10 25
ros2 10 53 25
* Power Supply Current
ips 11 6 9.5mA
* Models
.model qn npn(is=800.0E-18 bf=130 tf=0.2nS)
.model qna npn(is=864E-18 bf=150 tf=0.2nS)
.model qp pnp(is=800E-18 bf=60 tf=0.2nS)
.ends

```

EL2039C/EL2040C

Very High Slew Rate Wideband Operational Amplifier

EL2039C/EL2040C

EL2040 Macromodel — Contd.

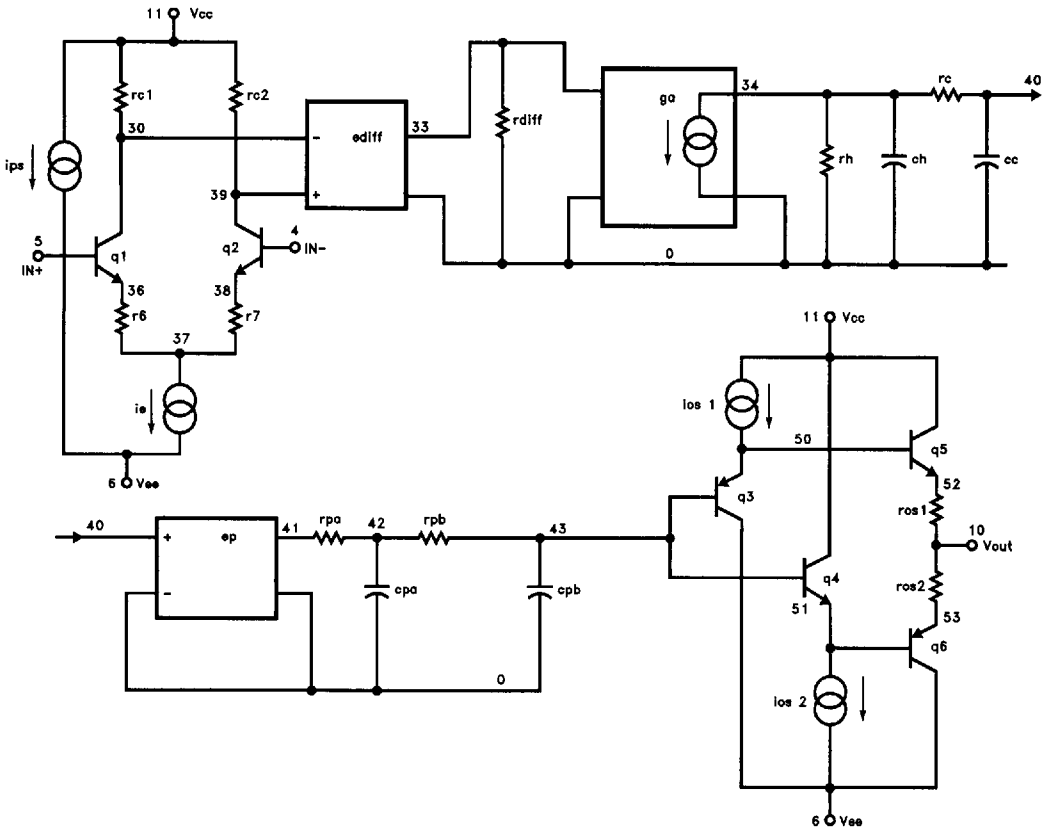

2039-20