

**Features**

- Excellent differential gain and phase on  $\pm 5V$  to  $\pm 15V$  supplies
- 100 MHz  $-3$  dB bandwidth from gains of  $\pm 1$  to  $\pm 10$
- 700 V/ $\mu s$  slew rate
- 0.1 dB flatness to 20 MHz
- Output disable in 50 ns - remains high impedance even when driven with large slew rates
- Single  $+5V$  supply operation
- AC characteristics are lot and temperature stable
- Available in small SO-8 package

**Applications**

- Video gain block
- Residue amplifier
- Multiplexer
- Current to voltage converter
- Coax cable driver with gain of 2
- ADC driver

**Ordering Information**

Part No.	Temp. Range	Package	Outline #
EL2120CN	0°C to +75°C	8-Pin P-DIP	MDP0031
EL2120CS	0°C to +75°C	8-Lead SO	MDP0027

**Connection Diagrams**

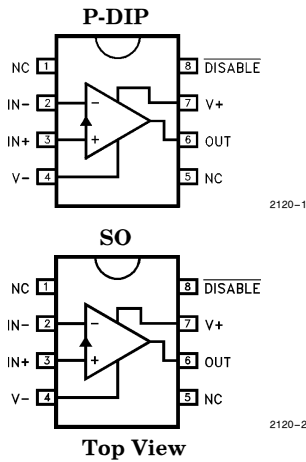

**General Description**

The EL2120C is a wideband current feedback amplifier optimized for video performance. Its 0.01% differential gain and 0.03 degree differential phase performance when at  $\pm 5V$  supplies exceeds the performance of other amplifiers running on  $\pm 15V$  supplies. Operating on  $\pm 8$  to  $\pm 15V$  supplies reduces distortions to 0.01% and 0.01 degrees and below. The EL2120C can operate with supplies as low as  $\pm 2.5V$  or a single  $+5V$  supply.

Being a current feedback design, bandwidth is a relatively constant 100 MHz over the  $\pm 1$  to  $\pm 10$  gain range. The EL2120C has been optimized for flat gain over frequency and all characteristics are maintained at positive unity gain. Because the input slew rate is similar to the 700 V/ $\mu s$  output slew rate the part makes an excellent high-speed buffer.

The EL2120C has a superior output disable function. Time to enable or disable is 50 ns and does not change markedly with temperature. Furthermore, in disable mode the output does not draw excessive currents when driven with 1000 V/ $\mu s$  slew rates. The output appears as a 3 pF load when disabled.

**Simplified Schematic**

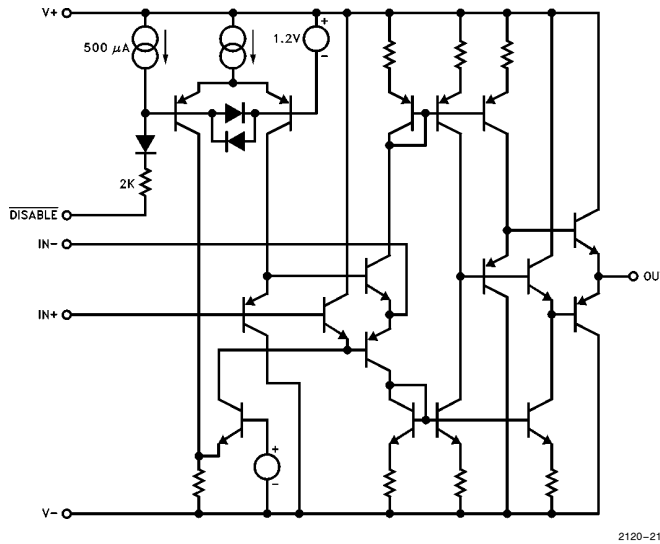

Note: All information contained in this data sheet has been carefully checked and is believed to be accurate as of the date of publication; however, this data sheet cannot be a "controlled document". Current revisions, if any, to these specifications are maintained at the factory and are available upon your request. We recommend checking the revision level before finalization of your design documentation.

# EL2120C

## 100 MHz Current Feedback Amplifier

### Absolute Maximum Ratings ( $T_A = 25^\circ\text{C}$ )

Voltage between $V+$ and $V-$	33V	Output Current	$\pm 50$ mA
Voltage at $+IN$ , $-IN$ , $V_{OUT}$	$(V-) - 0.5V$ to $(V+) + 0.5V$	Internal Power Dissipation	See Curves
Voltage between $+IN$ and $-IN$	$\pm 5V$	Operating Ambient Temperature Range	$0^\circ$ to $75^\circ\text{C}$
Voltage at /Disable	$(V+) - 10V$ to $(V+) + 0.5V$	Operating Junction Temperature	$150^\circ\text{C}$
Current into $+IN$ , $-IN$ , and /Disable	$\pm 5$ mA	P-DIP or SO	$150^\circ\text{C}$
		Storage Temperature Range	$-65^\circ\text{C}$ to $+150^\circ\text{C}$

#### Important Note:

All parameters having Min/Max specifications are guaranteed. The Test Level column indicates the specific device testing actually performed during production and Quality inspection. Elantec performs most electrical tests using modern high-speed automatic test equipment, specifically the LTX77 Series system. Unless otherwise noted, all tests are pulsed tests, therefore  $T_J = T_C = T_A$ .

Test Level	Test Procedure
I	100% production tested and QA sample tested per QA test plan QCX0002.
II	100% production tested at $T_A = 25^\circ\text{C}$ and QA sample tested at $T_A = 25^\circ\text{C}$ , $T_{MAX}$ and $T_{MIN}$ per QA test plan QCX0002.
III	QA sample tested per QA test plan QCX0002.
IV	Parameter is guaranteed (but not tested) by Design and Characterization Data.
V	Parameter is typical value at $T_A = 25^\circ\text{C}$ for information purposes only.

### Open Loop DC Electrical Characteristics

$V_S = \pm 5V$ ;  $R_L = 150\Omega$ ,  $T_A = 25^\circ\text{C}$  unless otherwise specified

Parameter	Description	Temp	Min	Typ	Max	Test Level	Units
$V_{OS}$	Input Offset Voltage $V_S = \pm 15V$	Full		4	20	II	mV
		Full		2	25	II	mV
$\Delta V_{OS}/\Delta T$	Input Offset Drift	Full		20		V	$\mu\text{V}/^\circ\text{C}$
$I_{B+}$	$+V_{IN}$ Input Bias Current	Full		5	15	II	$\mu\text{A}$
$I_{B-}$	$-V_{IN}$ Input Bias Current	Full		10	50	II	$\mu\text{A}$
CMRR	Common-Mode Rejection (Note 1)	Full	50	55		II	dB
$-ICMR$	$-$ Input Current Common-Mode Rejection (Note 1)	Full		8	20	II	$\mu\text{A}/V$
PSRR	Power Supply Rejection (Note 2)	Full	65	80		II	dB
$+IPSR$	$+$ Input Current Power Supply Rejection (Note 2)	$25^\circ\text{C}$		0.03		V	$\mu\text{A}/V$
$-IPSR$	$-$ Input Current Power Supply Rejection (Note 2)	Full		0.6	5	II	$\mu\text{A}/V$
$R_{OL}$	Transimpedance	Full	70	140		II	$\text{k}\Omega$
$A_{VOL}$	Voltage Gain	Full	58	66		II	dB
$+R_{IN}$	$+V_{IN}$ Input Impedance	$25^\circ\text{C}$		2		V	$\text{M}\Omega$

# EL2120C

## 100 MHz Current Feedback Amplifier

### Open Loop DC Electrical Characteristics — Contd.

$V_S = \pm 5V$ ;  $R_L = 150\Omega$ ,  $T_A = 25^\circ C$  unless otherwise specified

Parameter	Description	Temp	Min	Typ	Max	Test Level	Units
$V_{IN}$	$+V_{IN}$ Range	Full	$\pm 3.0$	$\pm 3.5$		II	V
$V_O$	Output Voltage Swing	Full	$\pm 3.0$	$\pm 3.5$		II	V
$I_{SC}$	Output Short-Circuit Current	$25^\circ C$		100		II	mA
$I_{O,DIS}$	Output Current, Disabled	Full		5	50	II	$\mu A$
$V_{DIS,ON}$	Disable Pin Voltage for Output Enabled	Full	$(V+) - 1$			II	V
$V_{DIS,OFF}$	Disable Pin Voltage for Output Disabled	Full			$(V+) - 4$	II	V
$I_{DIS,ON}$	Disable Pin Current for Output Enabled	Full			5	II	$\mu A$
$I_{DIS,OFF}$	Disable Pin Current for Output Disabled	Full	1.0			II	mA
$I_S$	Supply Current ( $V_S = \pm 15V$ )	Full		17	20	II	mA

Note 1: The input is moved from  $-3V$  to  $+3V$ .

Note 2: The supplies are moved from  $\pm 5V$  to  $\pm 15V$ .

### Closed Loop AC Electrical Characteristics

$V_S = \pm 15V$ ;  $A_V = +2$  ( $R_F = R_G = 270\Omega$ );  $R_L = 150\Omega$ ;  $C_L = 7$  pF;  $C_{IN-} = 2$  pF;  $T_A = 25^\circ C$

Parameter	Description	Min	Typ	Max	Test Level	Units
SR	Slew Rate; $V_{OUT}$ from $-3V$ to $+3V$ Measured at $-2V$ and $+2V$				V	$V/\mu s$
		$V_S = \pm 15V$	750		V	$V/\mu s$
	$V_S = \pm 5V$		550			
$t_S$	Settling Time to 0.25% of a 0 to $+10V$ Swing; $A_V = +1$ with $R_F = 270\Omega$ , $R_G = \infty$ , and $R_L = 400\Omega$		50		V	ns
BW	Bandwidth	$-3$ dB	95		V	MHz
		$\pm 1$ dB	50		V	MHz
		$\pm 0.1$ dB	16		V	MHz
BW@2.5V	Bandwidth at $V_S = \pm 2.5V$	$-3$ dB	75		V	MHz
		$\pm 1$ dB	35		V	MHz
		$\pm 0.1$ dB	11		V	MHz
Peaking			0.5		V	dB

# EL2120C

## 100 MHz Current Feedback Amplifier

### Closed Loop AC Electrical Characteristics — Contd.

$V_S = \pm 15V$ ;  $A_V = +2$  ( $R_F = R_G = 270\Omega$ );  $R_L = 150\Omega$ ;  $C_L = 7\text{ pF}$ ;  $C_{IN-} = 2\text{ pF}$ ;  $T_A = 25^\circ\text{C}$

Parameter	Description	Min	Typ	Max	Test Level	Units
dG	Differential Gain; DC Offset from $-0.7V$ through $+0.7V$ , AC Amplitude 286 mVp-p $V_S = \pm 15V$ , $f = 3.58\text{ MHz}$ $V_S = \pm 15V$ , $f = 30\text{ MHz}$ $V_S = \pm 5V$ , $f = 3.58\text{ MHz}$					
			< 0.01		V	%
			0.1		V	%
			0.01		V	%
d $\theta$	Differential Phase; DC Offset from $-0.7V$ through $+0.7V$ , AC Amplitude 286 mVp-p $V_S = \pm 15V$ , $f = 3.58\text{ MHz}$ $V_S = \pm 15V$ , $f = 30\text{ MHz}$ $V_S = \pm 5V$ , $f = 3.58\text{ MHz}$					
			0.01		V	$^\circ$
			0.1		V	$^\circ$
			0.06		V	$^\circ$

### Typical Performance Curves

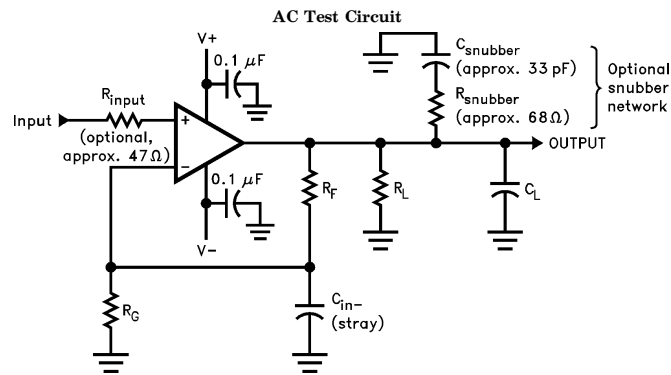

2120-3

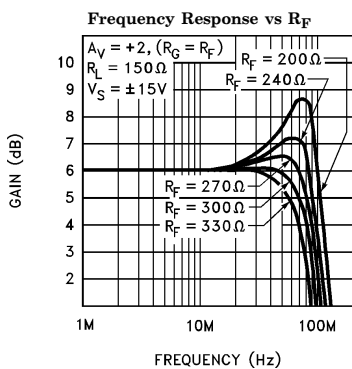

2120-4

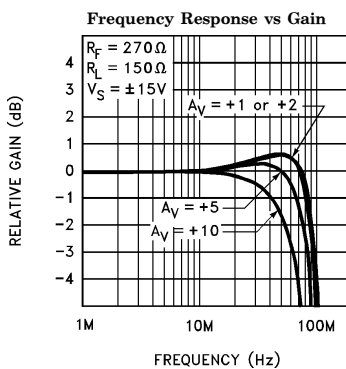

2120-5

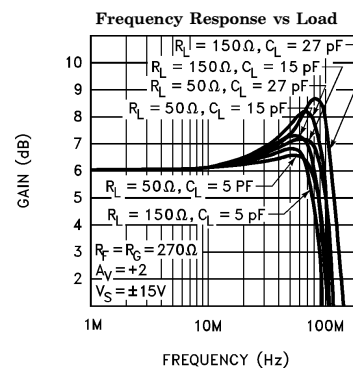

2120-6

# EL2120C

## 100 MHz Current Feedback Amplifier

### Typical Performance Curves — Contd.

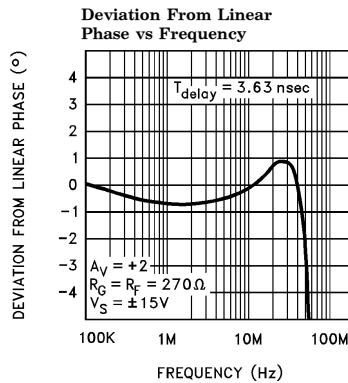
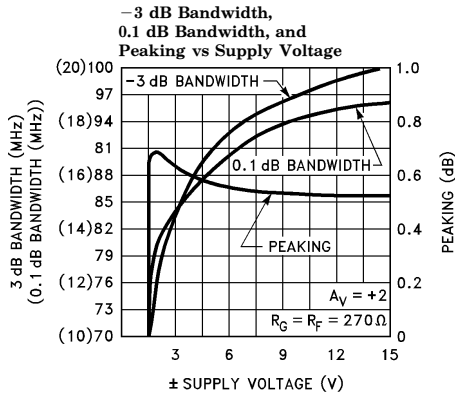
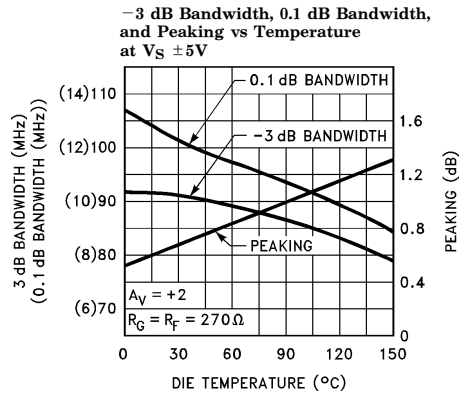
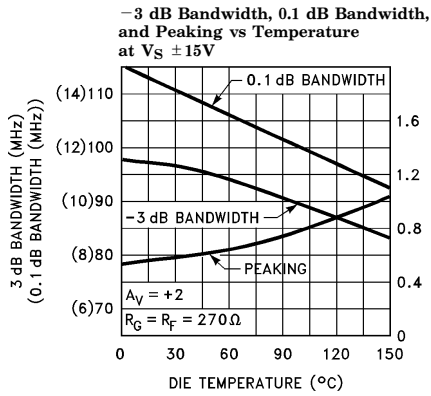
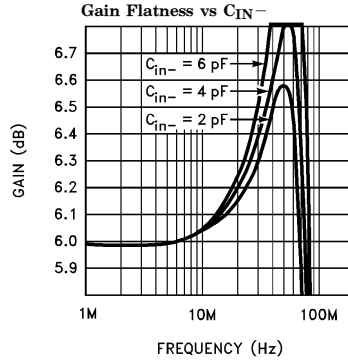
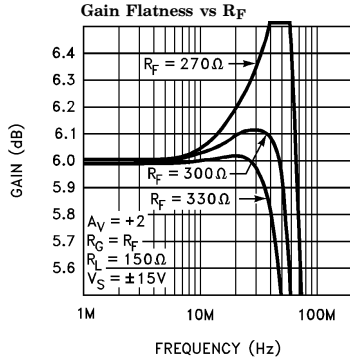

2120-7

# EL2120C

## 100 MHz Current Feedback Amplifier

### Typical Performance Curves — Contd.

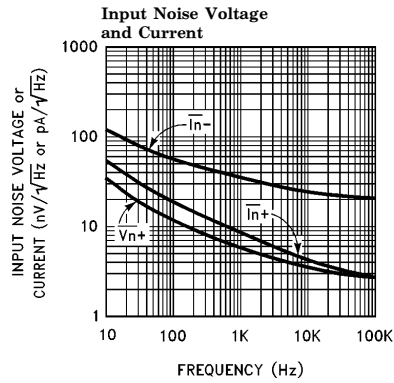
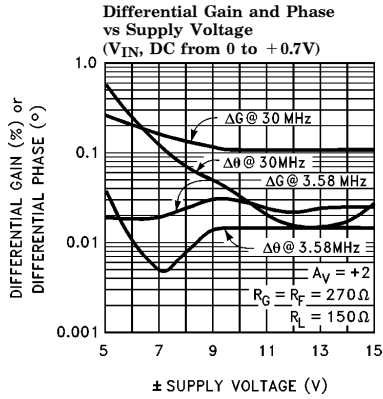
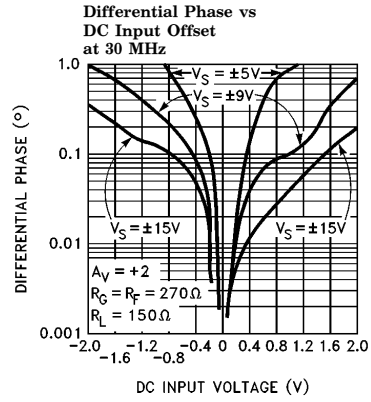
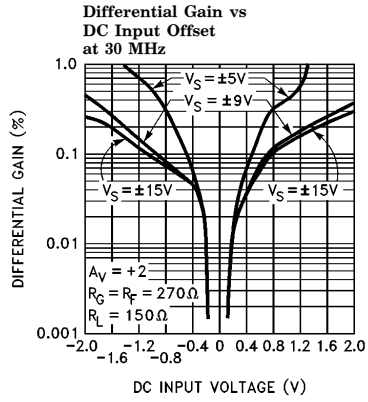
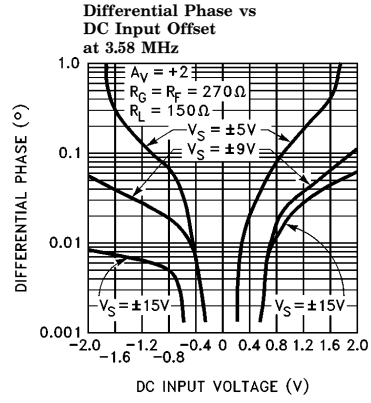
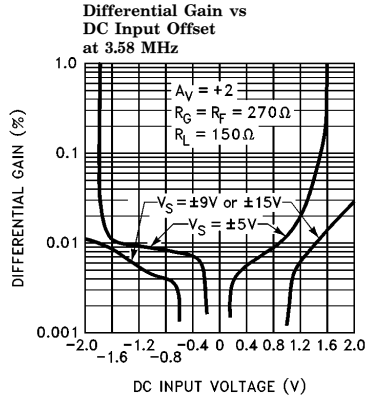

2120-8

# EL2120C

## 100 MHz Current Feedback Amplifier

### Typical Performance Curves — Contd.

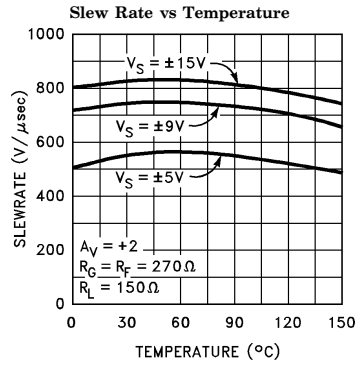
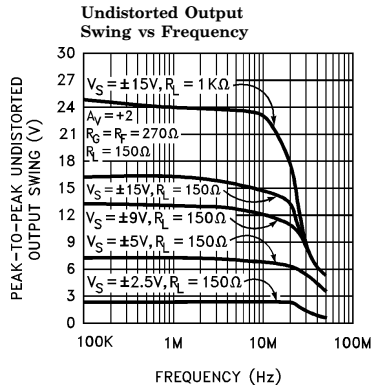

2120-9

### Small-Signal Transient Response

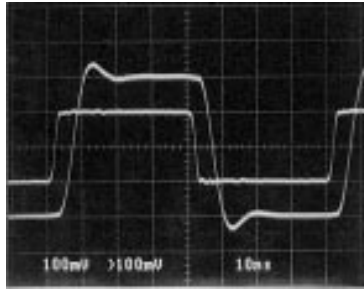

$A_V = +2, R_F = R_G = 270\Omega,$   
 $R_L = 150\Omega$

2120-10

### Large-Signal Transient Response

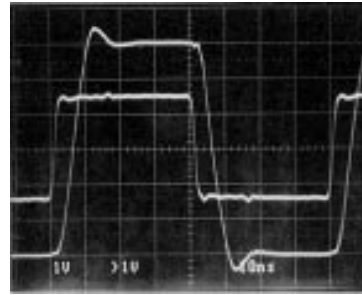

$A_V = +2, R_F = R_G = 270\Omega,$   
 $R_L = 150\Omega, V_S = \pm 15V$

2120-11

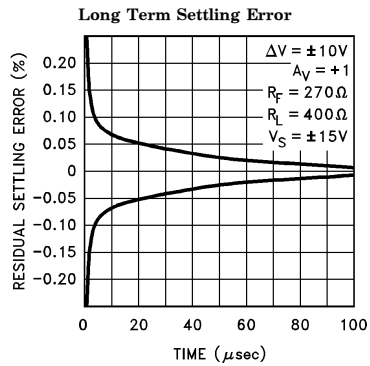
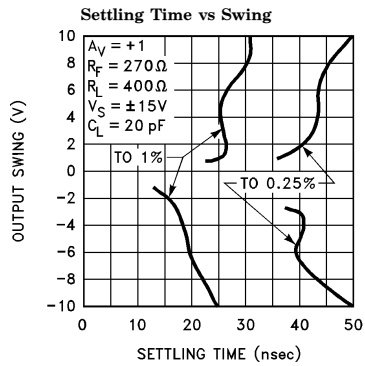

2120-12

# EL2120C

## 100 MHz Current Feedback Amplifier

### Typical Performance Curves — Contd.

Enable Response for a Family of Inputs

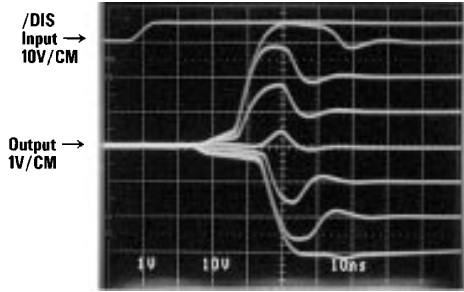

$A_V = +2$ ,  $R_L = 150\Omega$ ,  
 $V_S = \pm 5V$

2120-13

Disable Response for a Family of Inputs

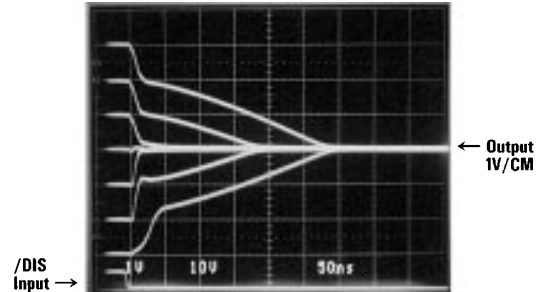

$A_V = +2$ ,  $R_L = 150\Omega$ ,  
 $V_S = \pm 5V$

2120-14

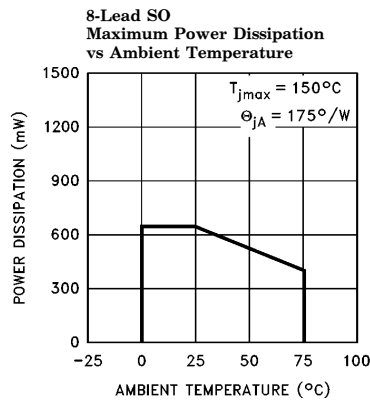
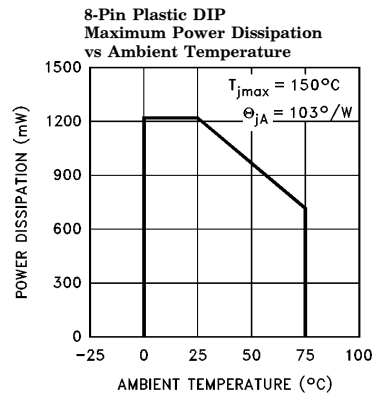
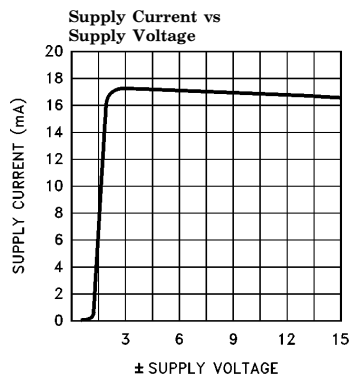

2120-15



# EL2120C

## 100 MHz Current Feedback Amplifier

### Applications Information

The EL2120C represents the third generation of current-feedback amplifier design. It is designed to provide good high-frequency performance over wide supply voltage, load impedance, gain, temperature, and manufacturing lot variations. It is a well-behaved amplifier in spite of its 100 MHz bandwidth, but a few precautions should be taken to obtain maximum performance.

The power supply pins must be well bypassed. 0.01  $\mu\text{F}$  ceramic capacitors are adequate, but lead length should be kept below  $\frac{1}{4}$ " and a ground plane is recommended. Bypassing with 4.7  $\mu\text{F}$  tantalum capacitors can improve settling characteristics, and smaller capacitors in parallel will not be needed. The lead length of sockets generally deteriorates the amplifier's frequency response by exaggerating peaking and increasing ringing in response to transients. Short sockets cause little degradation.

Load capacitance also increases ringing and peaking. Capacitance greater than 35 pF should be isolated with a series resistor. Capacitance at the  $V_{\text{IN}-}$  terminal has a similar effect, and should be kept below 5 pF. Often, the inductance of the leads of a load capacitance will be self-resonant at frequencies from 40 MHz to 200 MHz and can cause oscillations. A resonant load can be de-Q'ed with a small series or parallel resistor. A "snubber" can sometimes be used to reduce resonances. This is a resistor and capacitor in series connected from output to ground. Values of 68 $\Omega$  and 33 pF are typical. Increasing the feedback resistor can also improve frequency flatness.

The  $V_{\text{IN}+}$  pin can oscillate in the 200 MHz to 500 MHz realm if presented with a resonant or inductive source impedance. A series 27 $\Omega$  to 68 $\Omega$  resistor right on the  $V_{\text{IN}+}$  pin will suppress such oscillations without affecting frequency response.

-3 dB bandwidth is inversely proportional to the value of feedback resistor  $R_{\text{F}}$ . The EL2120C will tolerate values as low as 180 $\Omega$  for a maximum bandwidth of about 140 MHz, but peaking will increase and tolerance to stray capacitance will reduce. At gains greater than 5, -3 dB bandwidth begins to reduce, and a smaller  $R_{\text{F}}$  can be used to maximize frequency response.

The greatest frequency response flatness (to 0.1 dB, for instance) occurs with  $R_{\text{F}} = 300\Omega$  to 330 $\Omega$ . Even the moderate peaking caused by lower values of  $R_{\text{F}}$  will cause the gain to peak out of the 0.1 dB window, and higher values of  $R_{\text{F}}$  will cause an overcompensated response where the gain falls below the 0.1 dB level. Parasitic capacitances will generally degrade the frequency flatness.

The EL2120C should not output a continuous current above 50 mA, as stated in the ABSOLUTE MAXIMUM RATINGS table. The output current limit is set to 120 mA at a die temperature of 25°C and reduces to 85 mA at a die temperature of 150°C. This large current is needed to slew load capacitance and drive low impedance loads with low distortion but cannot be supported continuously. Furthermore, package dissipation capabilities cannot be met under short-circuit conditions. Current limit should not occur longer than a few seconds.

The output disable function of the EL2120C is optimized for video performance. While in disable mode, the feedthrough of the circuit can be modeled as a 0.2 pF capacitor from  $V_{\text{IN}+}$  to the output. No more than  $\pm 5\text{V}$  can be placed between  $V_{\text{IN}+}$  and  $V_{\text{IN}-}$  in disable mode, but this is compatible with common video signal levels. In disabled state the output can withstand about 1000 V/ $\mu\text{s}$  slew rate signals impressed on it without the output transistors turning on.

The /Disable pin logic level is referred to  $V+$ . With  $\pm 5\text{V}$  supplies, a CMOS or TTL driver with pull-up resistor will suffice.  $\pm 15\text{V}$  supplies require a +14/+11V drive span, or +15/+10V nominally. Open-collector TTL with a tapped pull-up resistor can provide these spans. The impedance of the divider should be 1k or less for optimum enable/disable speed.

The EL2120C enables in 50 ns or less. When  $V_{\text{IN}} = 0$ , only a small switching glitch occurs at the output. When  $V_{\text{IN}}$  is some other value, the output overshoots by about 0.7V when settling toward its new enabled value.

# EL2120C

## 100 MHz Current Feedback Amplifier

### Applications Information — Contd.

When the EL2120C disables, it turns off very rapidly for inputs of  $\pm 1V$  or less, and the output sags more slowly for inputs larger than this. For inputs as large as  $\pm 2.5V$  the output current can be absorbed by another EL2120C simultaneously enabled. Under these conditions, switching will be properly completed in 50 ns or less.

The greater thermal resistance of the SO-8 package requires that the EL2120C be operated from  $\pm 10V$  supplies or less to maintain the  $150^{\circ}C$  maximum die temperature over the commercial temperature range. The P-DIP package allows the full  $\pm 16.5V$  supply operation.

### Typical Applications Circuit—A High Quality Two-Input Multiplexer

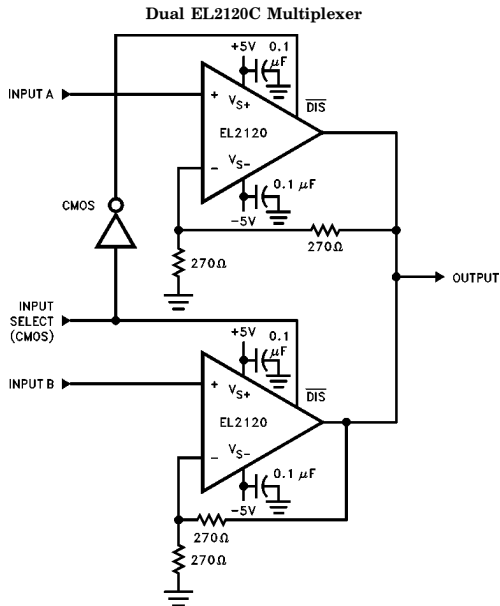

2120-16

Dual EL2120C Multiplexer Switching Channels: Uncorrelated Sinewave Switched to a Family of DC Levels

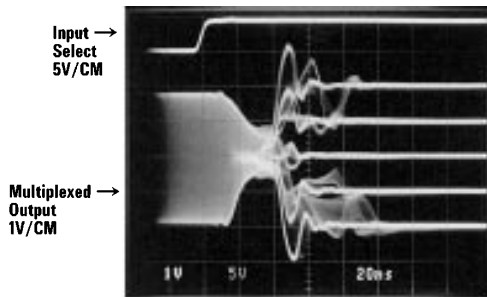

2120-18

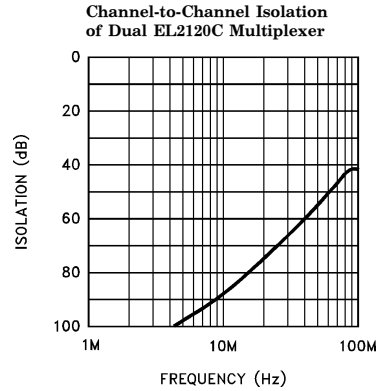

2120-17

Dual EL2120C Multiplexer Switching Channels: a Family of DC Levels Switched to an Uncorrelated Sinewave

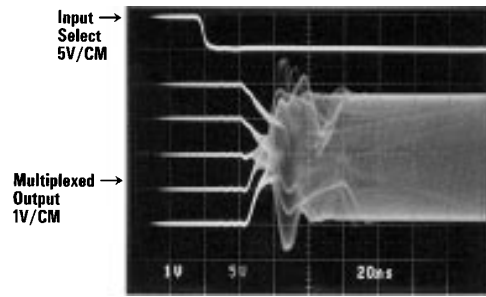

2120-19

# EL2120C

## 100 MHz Current Feedback Amplifier

### The EL2120C Macromodel

This macromodel has been developed to assist the user in simulating the EL2120C with surrounding circuitry. It was developed for the PSPICE simulator (copywritten by the Microsim corporation), and may need to be rearranged for other simulators, particularly the H operator. It approximates frequency response and small-signal transients as well, although the effects of load capacitance does not show. This model is slightly more complicated than the models used for low-frequency op-amps, but is much more accurate for AC.

The model does not simulate these characteristics accurately:

- |                            |                          |
|----------------------------|--------------------------|
| noise                      | non-linearities          |
| slew rate limitations      | temperature effects      |
| settling time              | manufacturing variations |
| input or output resonances | CMRR and PSRR            |

\* Revision A. March 1992

\* Enhancements include PSRR, CMRR, and Slew Rate Limiting

```
* Connections:  + input
*               |
*               | - input
*               |
*               | + Vsupply
*               | - Vsupply
*               |
*               | output
*               |
.subckt M2120  3  2  7  4  6
```

\* Input Stage

```
*
e1 10 0 3 0 1.0
vis 10 9 0V
h2 9 12 vxx 1.0
r1 2 11 25
l1 11 12 20nH
iinp 3 0 10µA
iinm 2 0 5µA
r12 3 0 2Meg
```

\* Slew Rate Limiting

```
*
h1 13 0 vis 600
r2 13 14 1K
d1 14 0 dclamp
s2 0 14 dclamp
```

\* High Frequency Pole

```
*
e2 30 0 14 0 0.001666666666
l5 30 17 1µH
c5 17 0 0.5pF
r5 17 0 600
```

\* Transimpedance Stage

```
*
g1 0 18 17 0 1.0
rol 18 0 140K
cdp 18 0 7.9pF
```

\* Output Stage

```
*
q1 4 18 19 qp
q2 7 18 20 qn
q3 7 19 21 qn
q4 4 20 22 qp
r7 21 6 4
r8 22 6 4
ios1 7 19 2.5mA
ios2 20 4 2.5mA
*
* Supply
*
ips 7 4 10mA
*
* Error Terms
*
ivos 0 23 5mA
vxx 23 0 0V
e4 24 0 6 0 1.0
e5 25 0 7 0 1.0
e6 26 0 4 0 1.0
r9 24 23 562
r10 25 23 10K
r11 26 23 10K
*
* Models
*
.model qn npn (is=5e-15 bf=500 tf=0.1nS)
.model qp pnp (is=5e-15 bf=500 tf=0.1nS)
.model dclamp d(is=1e-30 ibv=0.02 bv=4 n=4)
.ends
```

# EL2120C

## 100 MHz Current Feedback Amplifier

### The EL2120C Macromodel — Contd.

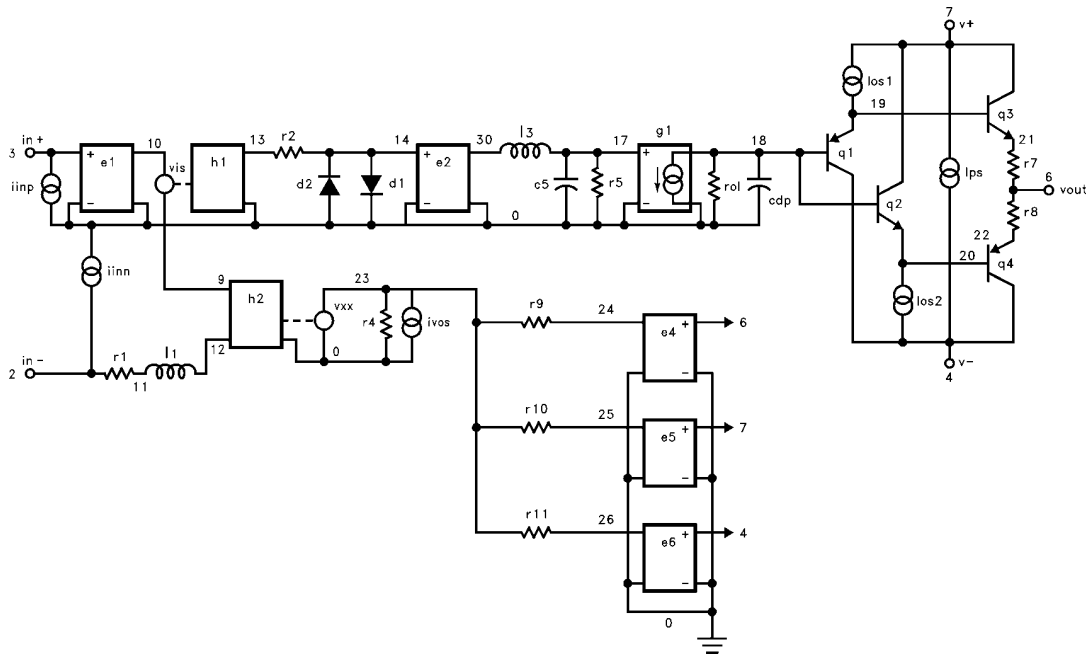

EL2120 Macromodel

2120-20

#### General Disclaimer

Specifications contained in this data sheet are in effect as of the publication date shown. Elantec, Inc. reserves the right to make changes in the circuitry or specifications contained herein at any time without notice. Elantec, Inc. assumes no responsibility for the use of any circuits described herein and makes no representations that they are free from patent infringement.

**élan****tec**  
HIGH PERFORMANCE ANALOG INTEGRATED CIRCUITS

#### Elantec, Inc.

1996 Tarob Court  
Milpitas, CA 95035  
Telephone: (408) 945-1323  
(800) 333-6314  
Fax: (408) 945-9305  
European Office: 44-71-482-4596

#### WARNING — Life Support Policy

Elantec, Inc. products are not authorized for and should not be used within Life Support Systems without the specific written consent of Elantec, Inc. Life Support systems are equipment intended to support or sustain life and whose failure to perform when properly used in accordance with instructions provided can be reasonably expected to result in significant personal injury or death. Users contemplating application of Elantec, Inc. products in Life Support Systems are requested to contact Elantec, Inc. factory headquarters to establish suitable terms & conditions for these applications. Elantec, Inc.'s warranty is limited to replacement of defective components and does not cover injury to persons or property or other consequential damages.