

élantec
HIGH PERFORMANCE ANALOG INTEGRATED CIRCUITS

EL2223/EL2223C

Dual, 500 MHz High Speed, Operational Amplifier

ELANTEC INC

T-79-07-20

EL2223/EL2223C

Features

- Wide gain bandwidth—500 MHz
- High slew rate—350 V/ μ s
- High power bandwidth ($\pm 10 V_{out}$) 5.5 MHz
- Large open loop gain 83 dB
- Low power—5 mA/amplifier
- Low input offset—0.5 mV typ.
- Wide supply voltage range $V_s = \pm 5V$ to $\pm 15V$
- Output short circuit protected

Applications

- High performance active filters
- Video and pulse amplifiers
- Local area networks
- Wideband amplifiers
- Replace two HA2540s

Ordering Information

Part No.	Temp. Range	Package	Outline #
EL2223CJ	0°C to +75°C	CerDIP	MDP0010
EL2223CN	0°C to +75°C	P-DIP	MDP0031
EL2223J	-55°C to +125°C	CerDIP	MDP0010
EL2223J/883B	-55°C to +125°C	CerDIP	MDP0010
EL2223L/883B	-55°C to +125°C	LCC	MDP0007
EL2223CM	0°C to +75°C	SOL	MDP0027

General Description

The EL2223 monolithic dual operational amplifier is an extension of Elantec's position in high speed analog products. This patented amplifier features 350 V/ μ s slew rate, a 500 MHz gain bandwidth gain-of-10 stable, along with an excellent speed power relationship. The dual 500 MHz EL2223 consumes only 10 mA, making it ideal for HA2540 type applications. The EL2223 has short-circuit-protected outputs and will operate from $\pm 5V$ to $\pm 15V$. It is fabricated using Elantec's complementary bipolar process which allows both fast PNP and NPN transistors to be manufactured on a single chip.

Elantec's products and facilities comply with MIL-STD-883 Revision C, MIL-I-45208A, and other applicable quality specifications. For information on Elantec's military processing, see Elantec document, QRA-2: "Elantec's Military Processing, Monolithic Integrated Circuits".

Connection Diagrams

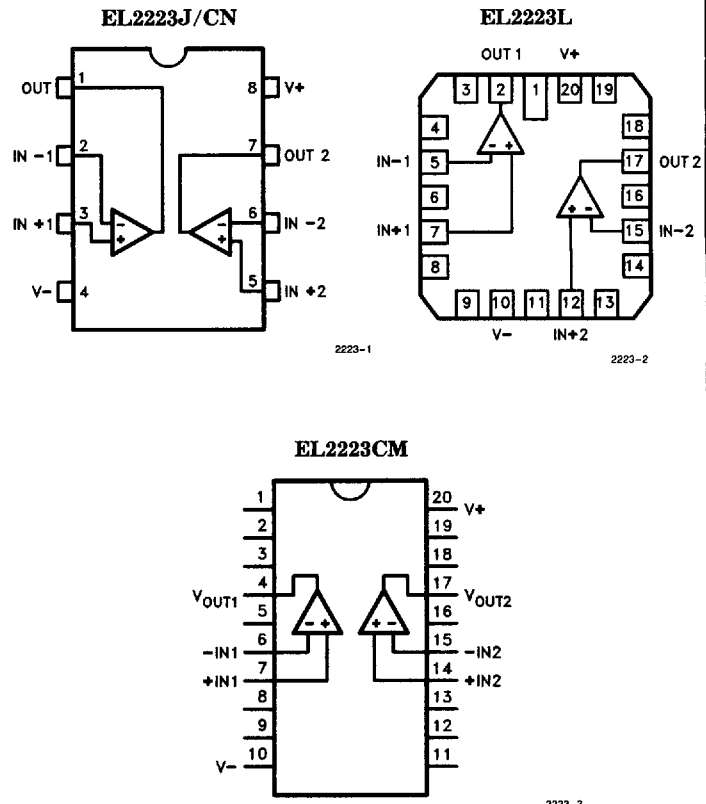

This product covered under U.S. Patent No. 4,837,523

1

July 1991 Rev B

EL2223/EL2223C

ELANTEC INC

Dual, 500 MHz High Speed, Operational Amplifier**Absolute Maximum Ratings** ($T_A = 25^\circ\text{C}$)

Voltage between V+ and V-	35V	Storage Temperature Range	-65°C to +150°C
Differential Input Voltage	±6V	Maximum Junction Temperature	
Internal Power Dissipation	See Curves	CerDIP, LCC	175°C
Peak Output Current	Short Circuit Protected	Plastic DIP, SOL	150°C
Output Short Circuit Duration (Note 1)	Continuous	Lead Temperature	
Operational Temperature Range		DIP Package	300°C
EL2223	-55°C to +125°C	SOL Package	
EL2223C	0°C to +75°C	Vapor Phase (60 seconds)	215°C
		Infrared (15 seconds)	220°C

Important Note:

All parameters having Min/Max specifications are guaranteed. The Test Level column indicates the specific device testing actually performed during production and Quality Inspection. Elantec performs most electrical tests using modern high-speed automatic test equipment, specifically the LTX77 Series system. Unless otherwise noted, all tests are pulsed tests, therefore $T_J = T_C = T_A$.

Test Level	Test Procedure
I	100% production tested and QA sample tested per QA test plan QCX0002.
II	100% production tested at $T_A = 25^\circ\text{C}$ and QA sample tested at $T_A = 25^\circ\text{C}$, T_{MAX} and T_{MIN} per QA test plan QCX0002.
III	QA sample tested per QA test plan QCX0002.
IV	Parameter is guaranteed (but not tested) by Design and Characterization Data.
V	Parameter is typical value at $T_A = 25^\circ\text{C}$ for information purposes only.

DC Electrical Characteristics $V_S = \pm 15\text{V}$; $R_L = 2\text{ k}\Omega$, unless otherwise specified

Parameter	Description	Temp	EL2223				EL2223C				Units
			Min	Typ	Max	Test Level	Min	Typ	Max	Test Level	
V _{OS}	Offset Voltage	+25°C		0.5	5	I		0.5	5	I	mV
		Full			8	I			8	III	mV
TCV _{OS}	Average Offset Voltage Drift	Full		3		V		3		V	μV/°C
I _B	Bias Current	+25°C		1.5	4	I		1.5	4	I	μA
		Full			6	I			6	III	μA
I _{OS}	Offset Current	+25°C		0.2	2	I		0.2	2	I	μA
		Full			3	I			3	III	μA
R _{IN}	Input Resistance	+25°C		6		V		6		V	kΩ
C _{IN}	Input Capacitance	+25°C		1		V		1		V	pF
V _{CM}	Common Mode Input Range	Full	±10	±12		I	±10	±12		II	V
e _{IN}	Input Noise Voltage ($f = 1\text{ kHz}$, $R_G = 0\Omega$)	+25°C		7		V		7		V	nV/√Hz
A _{VOL}	Large Signal Voltage Gain (Notes 2, 3)	+25°C	20k	40k		I	20k	40k		I	V/V
		Full	10k			I	10k			III	V/V

ELANTEC INC

EL2223/EL2223C
Dual, 500 MHz High Speed, Operational Amplifier

EL2223/EL2223C

DC Electrical Characteristics $V_S = \pm 15V$; $R_L = 2 k\Omega$, unless otherwise specified — Contd.

Parameter	Description	Temp	EL2223				EL2223C				Units
			Min	Typ	Max	Test Level	Min	Typ	Max	Test Level	
CMRR	Common-Mode Rejection Ratio (Note 4)	Full	70	90		I	70	90		II	dB
V_O	Output Voltage Swing	Full	± 11	± 12.5		I	± 11	± 12.5		II	V
I_{SC}	Short Circuit Current	+25°C		± 50	± 70	I		± 50	± 70	I	mA
R_O	Output Resistance	+25°C		40		V		40		V	Ω
I_S	Supply Current	Full		9.5	13	I		9.5	13	II	mA
PSRR	Power Supply Rejection Ratio (Note 5)	Full	70	90		I	70	90		II	dB

AC Electrical Characteristics $V_S = \pm 15V$; $R_L = 2 k\Omega$, unless otherwise specified

Parameter	Description	Temp	EL2223				EL2223C				Units
			Min	Typ	Max	Test Level	Min	Typ	Max	Test Level	
f_u	Open Loop Unity Bandwidth (Note 6)	+25°C		500		V		500		V	MHz
FPBW	Full Power Bandwidth (Notes 2, 7)	+25°C	3.98	5.5		I	3.98	5.5		I	MHz
t_r	Rise Time (Note 8)	+25°C		7		V		7		V	ns
OS	Overshoot (Note 8)	+25°C		30		V		30		V	%
SR	Slew Rate (Note 8)	+25°C	250	350		I	250	350		I	V/ μ s
t_s	Settling Time (Notes 9, 10) 10V Step to 0.05%	+25°C		330		V		330		V	ns
Ch S_p	Channel Separation (f = 10 MHz)			70		V		70		V	dB

Note 1: A heat sink is required to keep the junction temperature below absolute maximum when the output is shorted.

Note 2: $V_O = \pm 10V$.Note 3: $R_L = 2 k\Omega$.Note 4: Two tests are performed. $V_{CM} = 0V$ to +10V and $V_{CM} = 0V$ to -10V.Note 5: Two tests are performed. $V^+ = 15V$, and V^- is changed from -5V to -15V. $V^- = -15V$, and V^+ is changed from +5V to +15V.Note 6: $V_O = 100 mV$.Note 7: Full Power Bandwidth guaranteed based on slew rate measurement using: $FPBW = \text{Slew Rate} / 2\pi V_{peak}$.

Note 8: Refer to Test Circuit section of data sheet.

Note 9: Settling time measurement are made with techniques in the following reference: "Take The Guesswork Out of Settling-Time Measurements," EDN September 19, 1985.

Note 10: $A_V = +10$, $R_L = 2 k\Omega$.

EL2223/EL2223C

ELANTEC INC

Dual, 500 MHz High Speed, Operational Amplifier

Typical Performance Curves

Input Offset Voltage vs Supply Voltage

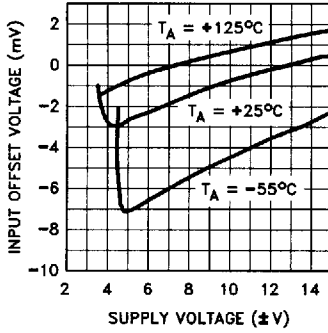

2223-4

Normalized Input Offset Voltage vs Temperature

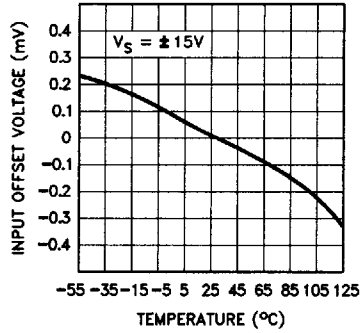

2223-5

Input Current vs Temperature

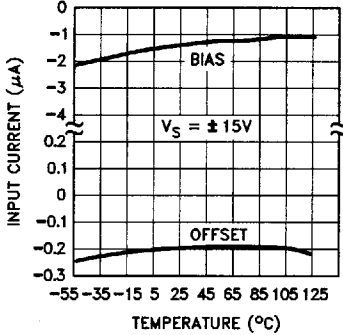

2223-6

Supply Current vs Supply Voltage

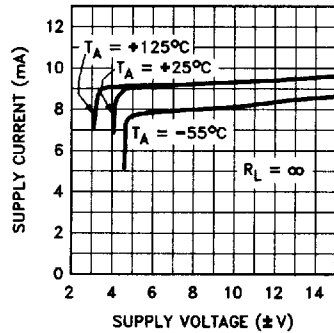

2223-7

Voltage Gain vs Temperature

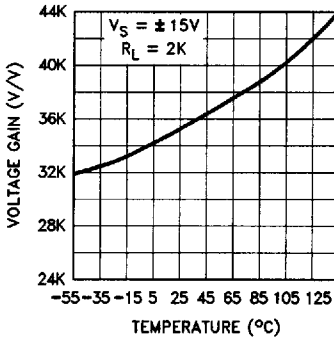

2223-8

Open Loop Voltage Gain vs Frequency

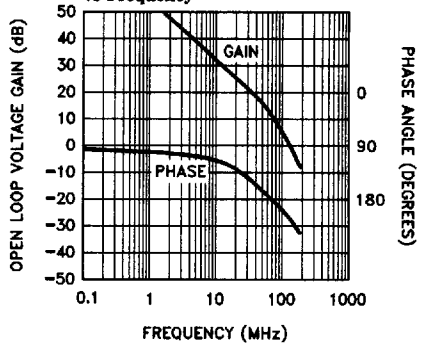

2223-9

ELANTEC INC

EL2223/EL2223C

Dual, 500 MHz High Speed, Operational Amplifier

EL2223/EL2223C

Typical Performance Curves — Contd.

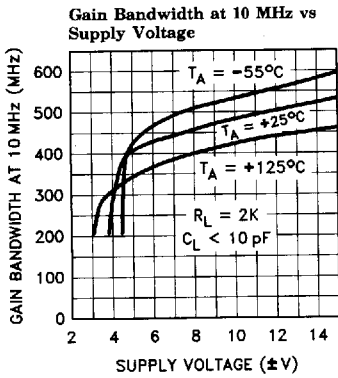

2223-10

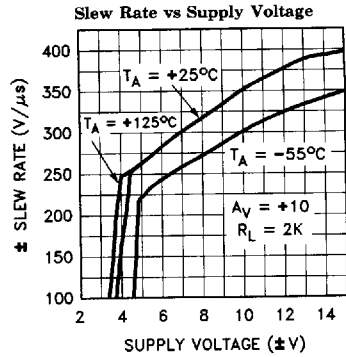

2223-11

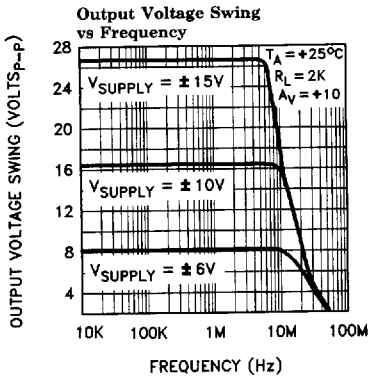

2223-12

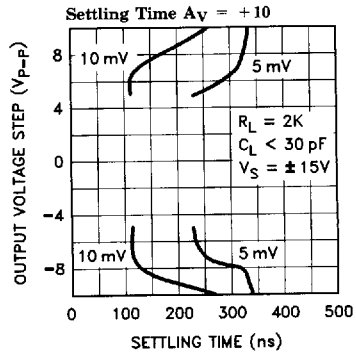

2223-13

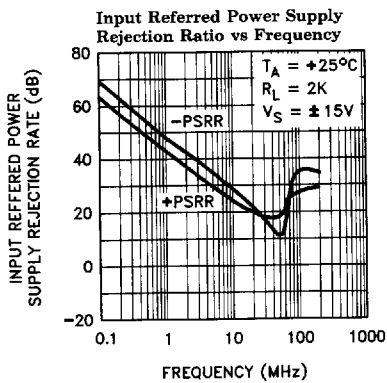

2223-14

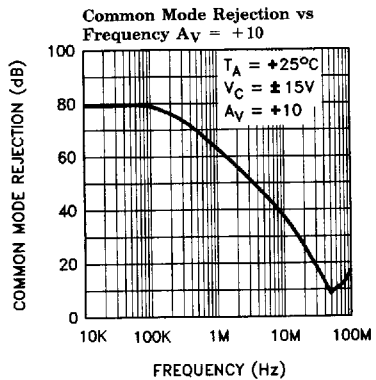

2223-15

1

EL2223/EL2223C

ELANTEC INC

Dual, 500 MHz High Speed, Operational Amplifier

Typical Performance Curves — Contd.

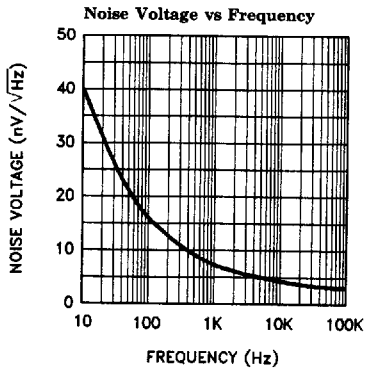

2223-16

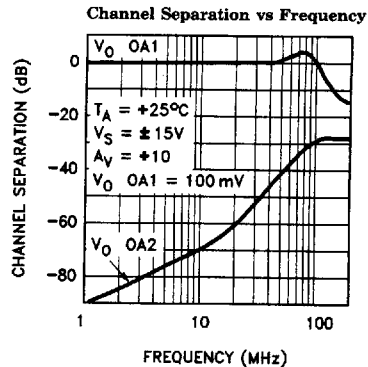

2223-17

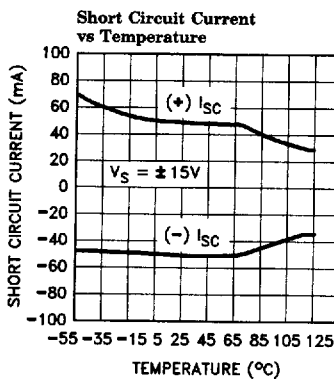

2223-18

Large Signal Response

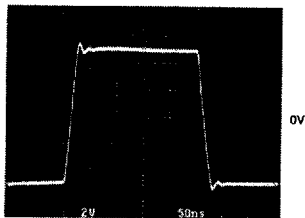

$A_V = +10$
 $V_{IN} = \pm 0.5\text{V}$
 $V_O = \pm 5\text{V}$
 $R_L = 2\text{k}$

2223-19

Small Signal Response

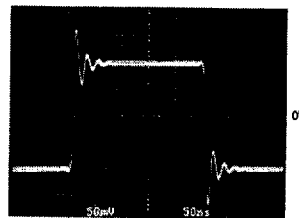

$A_V = +10$
 $V_{IN} = \pm 10\text{ mV}$
 $V_O = \pm 100\text{ mV}$
 $R_L = 2\text{k}$

2223-20

ELANTEC INC

EL2223/EL2223C

Dual, 500 MHz High Speed, Operational Amplifier

EL2223/EL2223C

Typical Performance Curves — Contd.

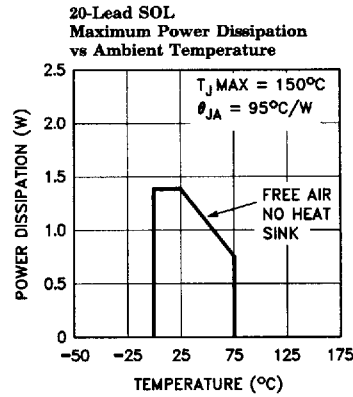
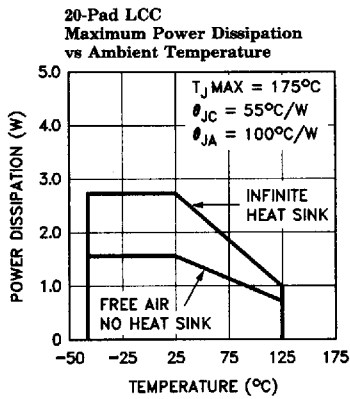
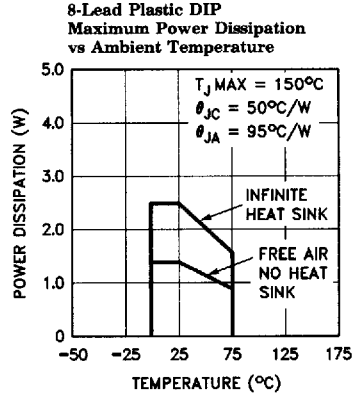
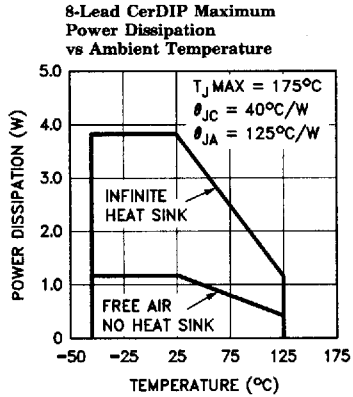

Test Circuit

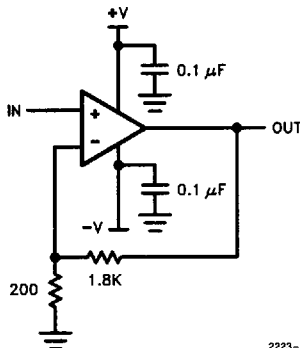

$A_V = +10$
 $C_L \leq 10 \text{ pF}$ Scope Probe

2223-27

Burn-In Circuit

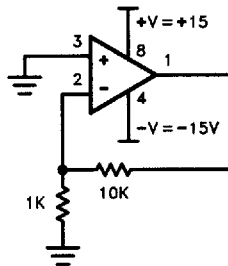

Pin numbers are for the 8-Lead CerDIP.
 Burn-in circuit is identical for all package types.

2223-28

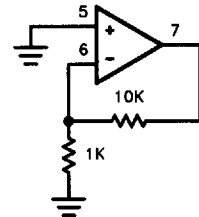

2223-29

EL2223/EL2223C

ELANTEC INC

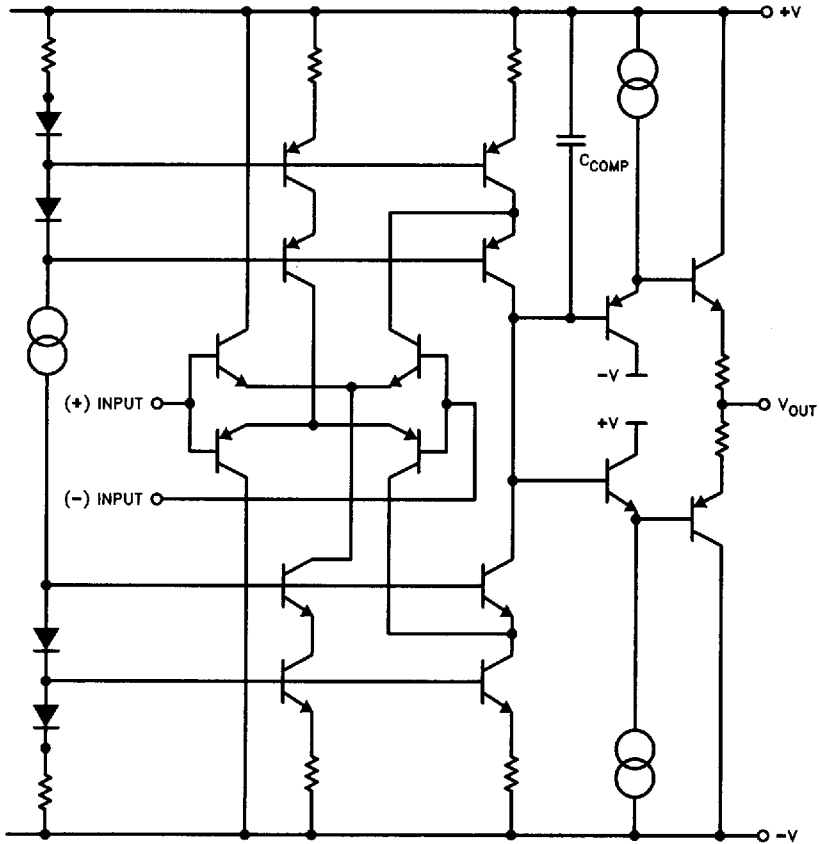
*Dual, 500 MHz High Speed, Operational Amplifier***Simplified Schematic** (one amplifier)

2223-25

ELANTEC INC

EL2223/EL2223C
Dual, 500 MHz High Speed, Operational Amplifier

EL2223/EL2223C

EL2223 Macromodel

```

* Connections:      + input
*                   |
*                   |      -input
*                   |      |
*                   |      |      + Vsupply
*                   |      |      |
*                   |      |      |      -Vsupply
*                   |      |      |      |
*                   |      |      |      |      output
*                   |      |      |      |      |
.subckt M2233      3      2      7      4      6

```

* Input stage

ie 37 4 2mA

r6 36 37 60

r7 38 37 60

rc1 7 30 75

rc2 7 39 75

q1 30 3 36 qn

q2 39 2 38 qna

ediff 33 0 39 30 7.25

rdiff 33 0 1Meg

* Compensation Section

ga 0 34 33 0 2.6m

rh 34 0 3Meg

ch 34 0 1.5pF

rc 34 40 600

cc 40 0 7pF

* Poles

ep 41 0 40 0 1

rpa 41 42 75

cpa 42 0 25pF

rpb 42 43 50

cpb 43 0 15pF

* Output Stage

ios1 7 50 1.25mA

ios2 51 4 1.25mA

q3 4 43 50 qp

q4 7 43 51 qn

q5 7 50 52 qn

q6 4 51 53 qp

ros1 52 6 25

ros2 6 53 25

* models

.model qn npn (is=800.0E-18 bf=250 tf=0.2nS)

.model qna npn (is=864E-18 bf=300 tf=0.2nS)

.model qp pnp (is=800E-18 bf=60 tf=0.2nS)

.ends

1

EL2223/EL2223C

ELANTEC INC

Dual, 500 MHz High Speed, Operational Amplifier

EL2223 Macromodel — Contd.

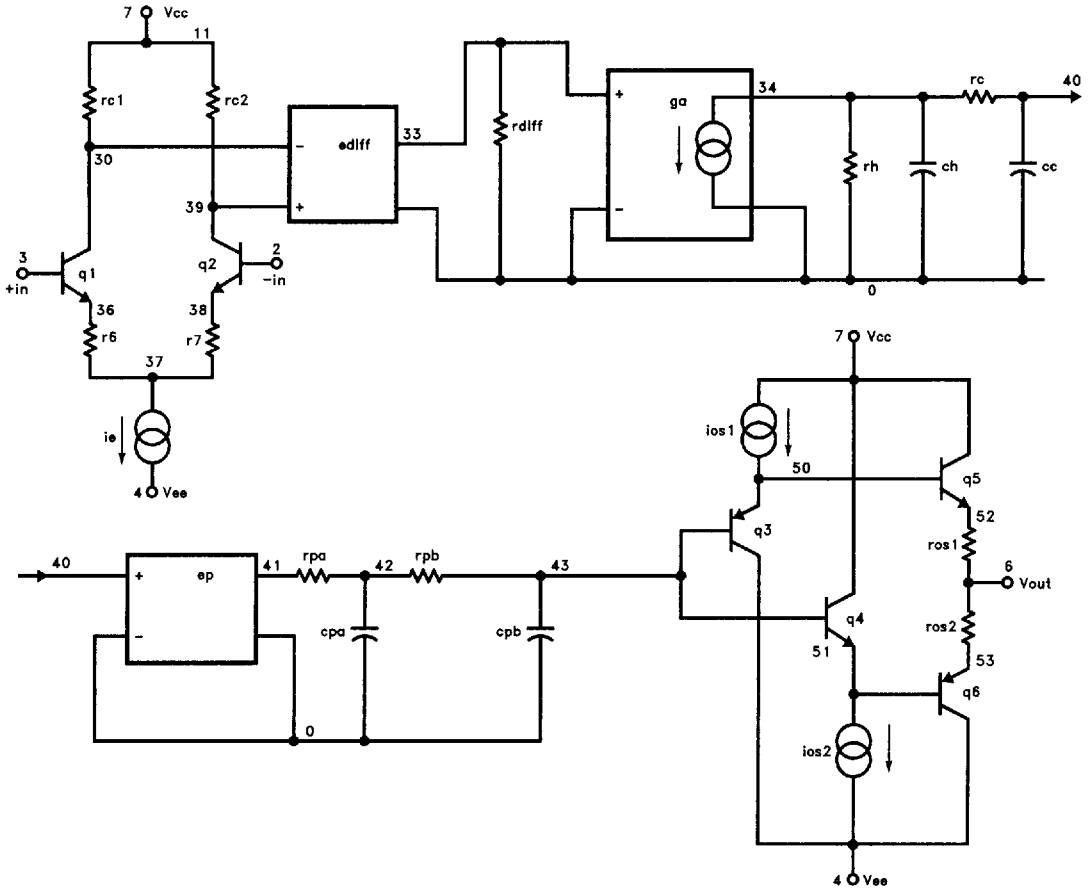

2223-90