

# élantec

HIGH PERFORMANCE ANALOG INTEGRATED CIRCUITS

## EL2243/EL2243C

Dual Fast Single-Supply Decompensated Op Amp

ELANTEC INC

T-79-10

### Features

- Inputs and outputs operate at negative supply rail
- Gain bandwidth product—70 MHz
- High slew rate—90 V/ $\mu$ s
- Settles to 0.01% of a 10V swing in 400 ns
- Operates with supplies as low as 3V or as great as 32V while consuming only 3.7 mA per amplifier
- Large open loop gain—114 dB
- Inputs tolerant of overload
- MIL-STD-883 Rev. C compliant

### Applications

- Battery-powered instruments
- 12-bit DAC output amplifiers
- Fast-settling instrumentation amplifiers

### Ordering Information

Part No.	Temp. Range	Package	Outline #
EL2243CJ	0°C to +75°C	8-Pin CerDIP	MDP0010
EL2243CN	0°C to +75°C	8-Pin P-DIP	MDP0031
EL2243CM	0°C to +75°C	20-Lead SOL	MDP0027
EL2243J	-55°C to +125°C	8-Pin CerDIP	MDP0010
EL2243J/883B	-55°C to +125°C	8-Pin CerDIP	MDP0010

### General Description

The EL2243 dual monolithic operational amplifier is as flexible as prior 324 devices but offers 100 times the bandwidth and slewrate. Its inputs and outputs are able to operate down to the negative supply and are not damaged by overloads.

The EL2243 is useable in battery-operated systems with supplies as low as 3V, yet it has excellent gain and settling times while consuming only 3.7 mA per amplifier.

Elantec's EL2243/883B complies with MIL-STD-883 Revision C in all aspects, including burn-in at 125°C. Elantec's facilities comply with MIL-I-45208A and other applicable quality specifications. For information on Elantec's military processing, see the Elantec document QRA-2: "Elantec's Military processing-Monolithic Products".

### Connection Diagrams

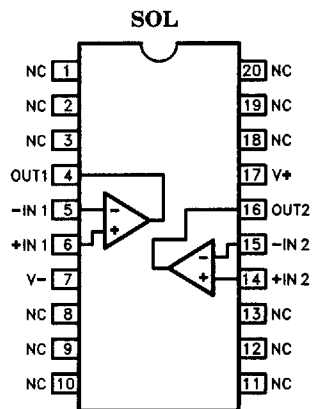
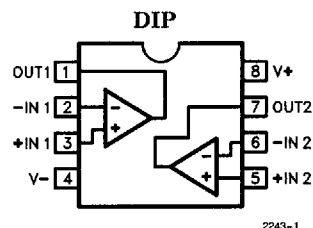

ELANTEC INC

# EL2243/EL2243C

## Dual Fast Single-Supply Decompensated Op Amp

EL2243/EL2243C

### Absolute Maximum Ratings ( $T_A = 25^\circ\text{C}$ )

Voltage between $V^+$ and $V^-$	36V	Operating Junction Temperature	
Voltage between $-IN$ and $+IN$ Pins	36V	CerDIP	175°C
Voltage at $-IN$ or $+IN$ Pins	$V^+$ to $V^-$	Plastic DIP	150°C
Output Current	50 mA (Peak)	Storage Temperature Range	-65°C to +150°C
	30 mA (Continuous)	Lead Temperature	
Current into $+IN$ or $-IN$	5 mA	DIP Package	
Internal Power Dissipation	See Curves	(Soldering, 10 seconds)	300°C
Operating Ambient Temperature Range		SOL Package	
EL2243	-55°C to +125°C	Vapor Phase (<60 seconds)	215°C
EL2243C	0°C to +75°C	Infrared (<15 seconds)	220°C

#### Important Note:

All parameters having Min/Max specifications are guaranteed. The Test Level column indicates the specific device testing actually performed during production and Quality inspection. Elantec performs most electrical tests using modern high-speed automatic test equipment, specifically the LTX77 Series system. Unless otherwise noted, all tests are pulsed tests, therefore  $T_J = T_C = T_A$ .

Test Level	Test Procedure
I	100% production tested and QA sample tested per QA test plan QCX0002.
II	100% production tested at $T_A = 25^\circ\text{C}$ and QA sample tested at $T_A = 25^\circ\text{C}$ , $T_{MAX}$ and $T_{MIN}$ per QA test plan QCX0002.
III	QA sample tested per QA test plan QCX0002.
IV	Parameter is guaranteed (but not tested) by Design and Characterization Data.
V	Parameter is typical value at $T_A = 25^\circ\text{C}$ for information purposes only.

### DC Electrical Characteristics $V_S = \pm 15\text{V}$ , $R_L = 1\text{k}$ , $T_A = 25^\circ\text{C}$ unless otherwise specified

Parameter	Description	Temp	Min	Typ	Max	Test Level		Units
						EL2243	EL2243C	
$V_{OS}$	Input Offset Voltage	25°C	Full	1.5	7 9	I	I	mV
						I	III	mV
$TCV_{OS}$	Average Offset Voltage Drift	Full		5		V	V	$\mu\text{V}/\text{C}$
$I_B$	Input Bias Current	25°C	Full	0.5	1.0 2.0	I	I	$\mu\text{A}$
						I	III	$\mu\text{A}$
$I_{OS}$	Input Offset Current	25°C	Full	0.01	0.1 0.2	I	I	$\mu\text{A}$
						I	III	$\mu\text{A}$
$R_{IN, Diff}$	Input Differential Resistance	25°C		10		V	V	$\text{M}\Omega$
$R_{IN, Comm}$	Input Common-Mode Resistance	25°C		100		V	V	$\text{M}\Omega$
$C_{IN}$	Input Capacitance	25°C		2		V	V	pF
$V_{CM+}$	Positive Common-Mode Input Range	Full	12	13.3		I	II	V
$V_{CM-}$	Negative Common-Mode Input Range	Full	-15	-15.3		I	II	V
$E_{IN}$	Input Noise Voltage ( $f = 1\text{ kHz}$ , $R_G = 0\Omega$ )	25°C		12		V	V	$\text{nV}/\sqrt{\text{Hz}}$
$A_{VOL}$	Large Signal Voltage Gain ( $V_O = \pm 10\text{V}$ )	25°C	Full	250 15	500	I	I	V/mV
						I	III	V/mV
CMRR	Common-Mode Rejection Ratio (Note 1)	Full	70	100		I	II	dB

**EL2243/EL2243C**

ELANTEC INC

**Dual Fast Single-Supply Decompensated Op Amp****DC Electrical Characteristics**  $V_S = \pm 15V, R_L = 1k; T_A = 25^\circ C$  unless otherwise specified — Contd.

Parameter	Description	Temp	Min	Typ	Max	Test Level		Units
						EL2243	EL2243C	
PSRR	Power-Supply Rejection Ratio (Note 2)	Full	70	100		I	II	dB
$V_O$	Output Voltage Swing Negative Swing, $R_L$ to $V^-$	Full	$\pm 12$	$\pm 13.5$		I	II	V
		Full	-14.98	-15		I	II	V
$I_O$	Output Current (Note 3)	Full	$\pm 12$	$\pm 25$	$\pm 50$	I	II	mA
$I_S$	Supply Current (Both Amplifiers)	Full		8.2	10	I	II	mA

**AC Electrical Characteristics**  $V_S = \pm 15V; R_L = 1k\Omega; C_L = 20pF; T_A = 25^\circ C$ ; unless otherwise specified

Parameter	Description	Min	Typ	Max	Test Level		Units
					EL2243	EL2243C	
GBW	Gain-Bandwidth Product (Note 4)		70		V	V	MHz
SR	Slew Rate ( $V_O = \pm 10V$ )		90		V	V	V/ $\mu s$
OS	Overshoot (Note 4)		30		V	V	%
$t_s$	Settling Time 10V Step	to 0.1%	320		V	V	ns
		to 0.01%	380		V	V	ns

Note 1: Two tests are performed with  $V_{CM} = 0V$  to  $-12V$  and  $V_{CM} = 0V$  to  $12V$ .

Note 2: Two tests are performed with  $V^+ = 3V$ ,  $V^-$  changed from  $-2V$  to  $-27V$ ;  $V^- = -2V$ ,  $V^+$  changed from  $3V$  to  $28V$ .

Note 3: The inputs are overdriven by  $\pm 15V$  and the output  $R_1 = 100\Omega$ .

Note 4:  $V_{OUT} = 100mV$  peak-to-peak.

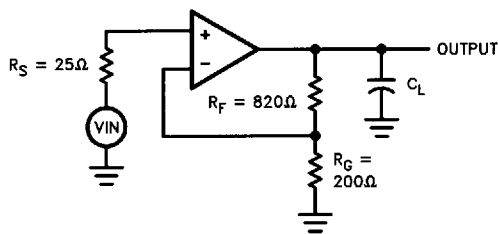
**Test Circuit**

2243-3

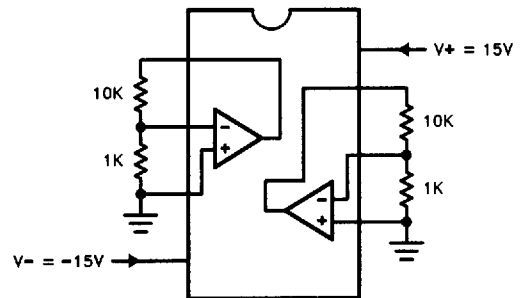
**Burn-In Circuit**

2243-4

ELANTEC INC

# EL2243/EL2243C

## Dual Fast Single-Supply Decompensated Op Amp

EL2243/EL2243C

### Typical Performance Curves

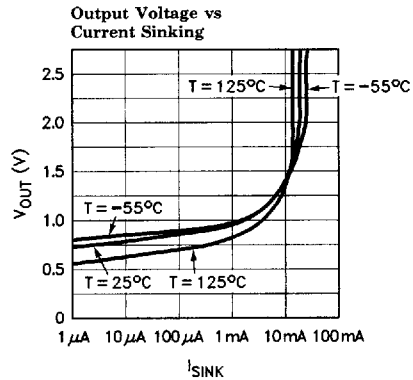
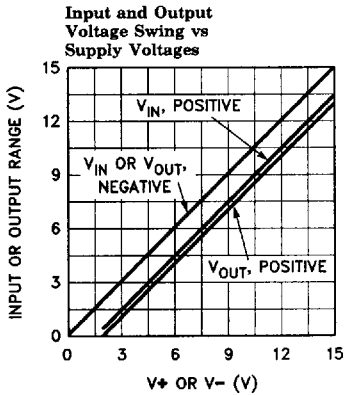
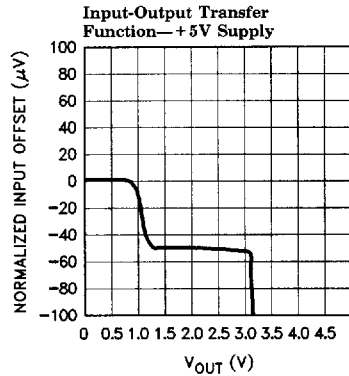
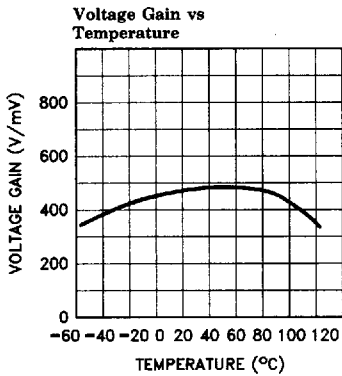
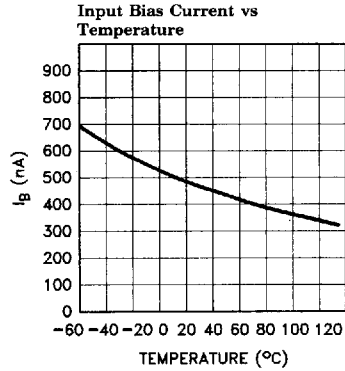
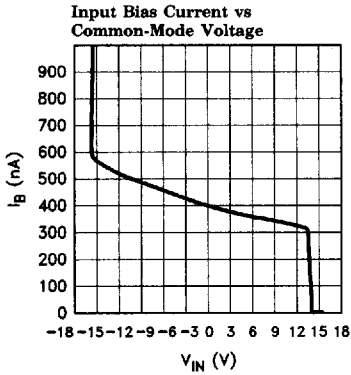

2243-5

# EL2243/EL2243C

ELANTEC INC

## Dual Fast Single-Supply Decompenated Op Amp

### Typical Performance Curves — Contd.

Supply Current vs Supply Voltage— Both Amplifiers

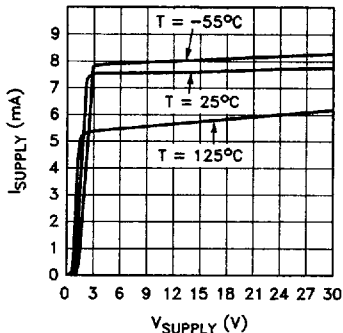

Supply Current vs Temperature— Both Amplifiers

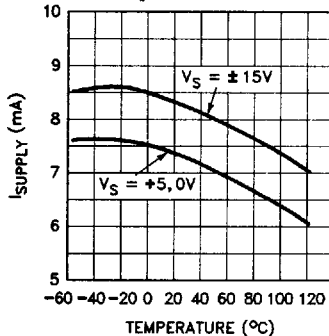

Output Short-Circuit Current vs Temperature

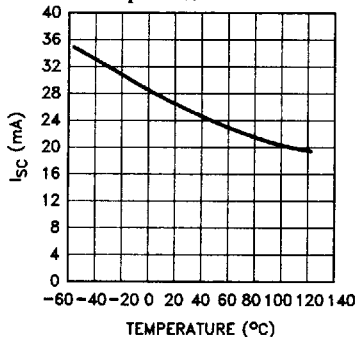

Input Voltage Noise vs Frequency

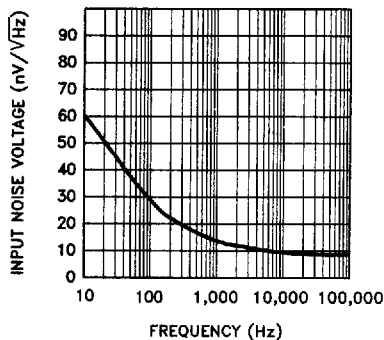

Power Supply Rejection Ratio vs Frequency

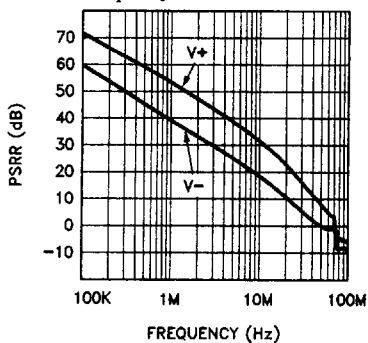

Common-Mode Rejection Ratio vs Frequency

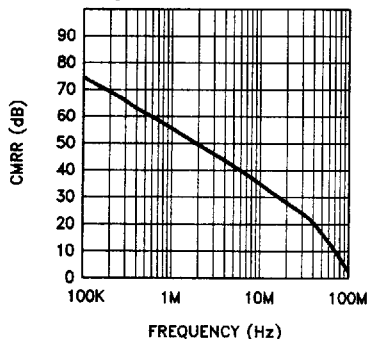

Typical Performance Curves — Contd.

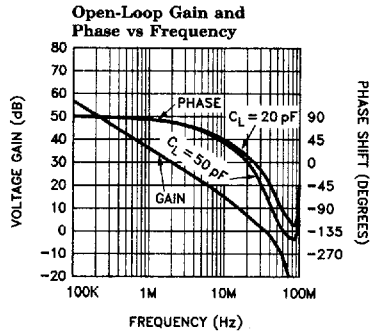
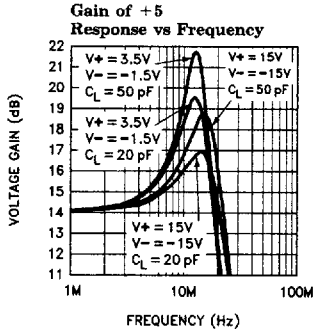

**Pulse Response with  $V+ = 15V, V- = -15V$**

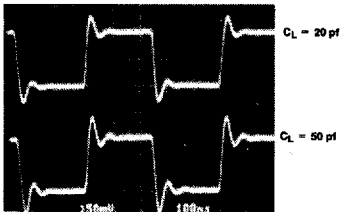

**Pulse Response with  $V+ = 3V, V- = -2V$**



**Slew Characteristic**

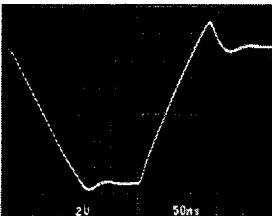

**Slew Rate vs Temperature**

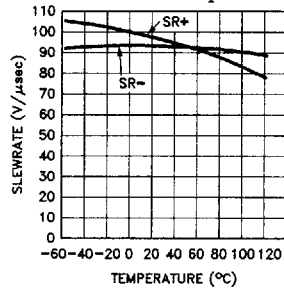

**Settling Time vs Output Swing  $V_S = \pm 15V$**

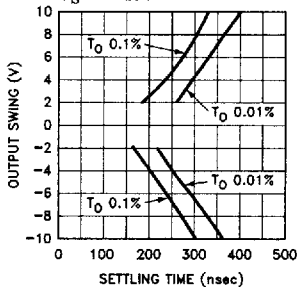

**Amplifier-to-Amplifier Isolation vs Frequency**

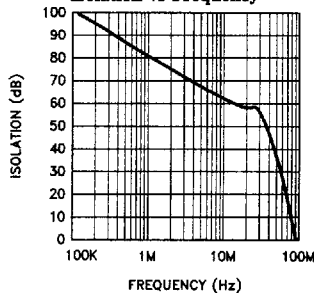

# EL2243/EL2243C

ELANTEC INC

## Dual Fast Single-Supply Decompensated Op Amp

### Typical Performance Curves — Contd.

8-Lead Plastic DIP  
Maximum Power Dissipation  
vs Ambient Temperature

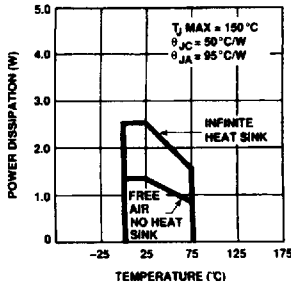

2243-13

8-Pin CerDIP Package  
Maximum Power Dissipation  
vs Ambient Temperature

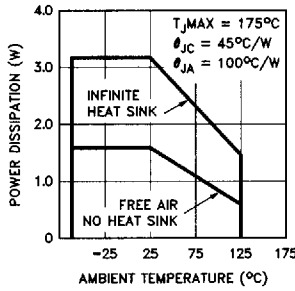

2243-14

20-Lead SOL  
Maximum Power Dissipation  
vs Ambient Temperature

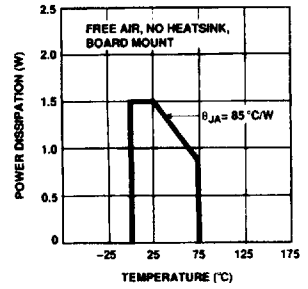

2243-15

### Simplified Schematic (One Amplifier)

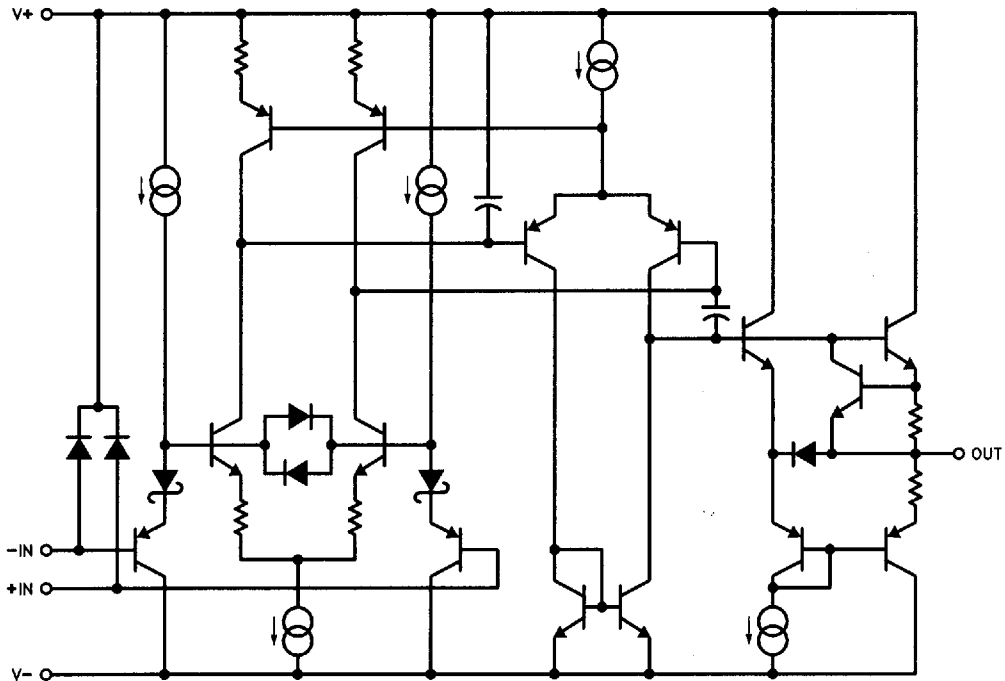

2243-16

ELANTEC INC

**EL2243/EL2243C****Dual Fast Single-Supply Decompensated Op Amp**

EL2243/EL2243C

### Applications Information

The EL2243 is a fast amplifier designed to operate from a very wide range of power supply voltages. The inputs operate all the way to the negative supply (actually about 200 mV below it) and up to typically 2V below the positive supply. The outputs swing a similar range, but some attention is required in practice.

Specifically, while the output NPN transistor can source load current over the full output span (see the simplified schematic), the output PNP device simply turns off at negative swings below about a volt above the negative supply rail. This property is shown in the "Output Voltage vs. Current-Sinking" typical curve. All single-supply amplifiers have this characteristic, and the solution is to provide a load resistor from the output to the negative supply rail.

When the output is in this extreme negative swing region, the bandwidth, gain, and settling properties are all degraded by a factor of about 2. Even so, the AC characteristics are well-behaved in this region.

Electrostatic discharge protection devices clamp the inputs a diode drop above  $V^+$  and a diode drop below  $V^-$ .

As for all amplifiers, good supply bypassing will optimize settling and amplifier-to-amplifier rejection. 4.7  $\mu\text{F}$  tantalum capacitors seem to be the best, and no additional small capacitor is needed in parallel for very high-frequency bypassing. Reasonably low feedback impedances are important to preserving closed-loop stability, 1k or less being acceptable when capacitive parasitics are minimized. Stability is best when the EL2243 is operated from large supplies, especially when driving capacitive loads.

1



**EL2243/EL2243C** ELANTEC INC**Dual Fast Single-Supply Decompensated Op Amp****EL2243 Macromodel**

```

* Connections:      + input
*                   |
*                   | - input
*                   |
*                   | + Vsupply
*                   |
*                   | - Vsupply
*                   |
*                   | output
*                   |

```

```

.subckt M2243      3      2      7      4      6

```

## \* Input stage

```

ie 7 37 200uA
r6 36 37 1K
r7 38 37 1K
rc1 4 30 3K
rc2 4 39 3K
q1 30 3 36 qp
q2 39 2 38 qpa
ediff 33 0 39 30 1.0
rdiff 33 0 1Meg

```

## \* Compensation Section

```

ga 0 34 33 0 1m
rh 34 0 175Meg
ch 34 0 4pF
rc 34 40 1K
cc 40 0 4pF

```

## \* Poles

```

ep 41 0 40 0 1.0
rpa 41 42 1K
cpa 42 0 4pF
rpb 42 43 1K
cpb 43 0 2pF

```

## \* Output Stage

```

ios1 7 50 1.0mA
ios2 51 4 1.0mA
q3 4 43 50 qp
q4 7 43 51 qn
q5 7 50 52 qn
q6 4 51 53 qp
ros1 52 6 25
ros2 6 53 25

```

## \* Power Supply Current

```

ips 7 4 1.5mA

```

## \* Models

```

.model qn npn(is = 800e - 18 bf = 100 tf = 0.2nS)
.model qpa pnp(is = 864e - 18 bf = 150 tf = 0.2nS)
.model qp pnp(is = 800e - 18 bf = 125 tf = 0.2nS)
.ends

```

ELANTEC INC

# EL2243/EL2243C

*Dual Fast Single-Supply Decompenated Op Amp*

EL2243/EL2243C

## EL2243 Macromodel — Contd.

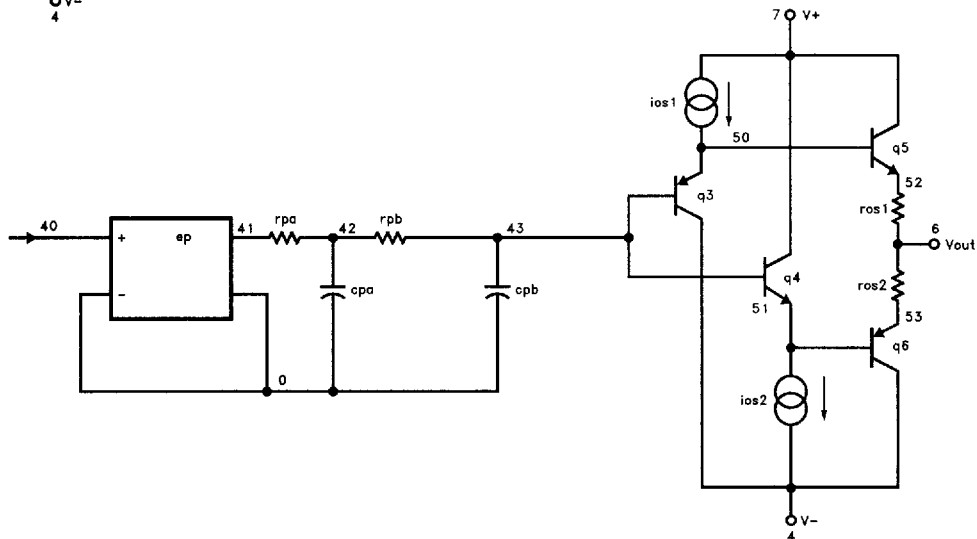
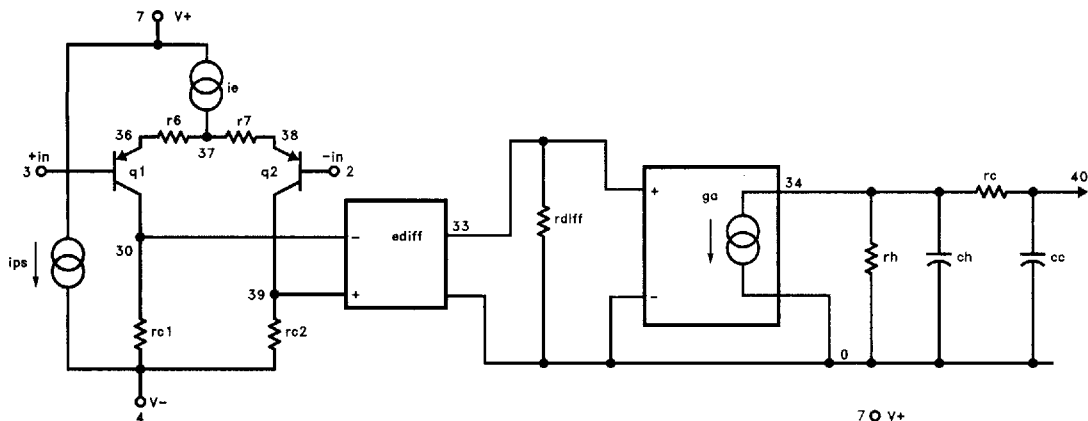

2243-17