

EL4331

Triple 2:1 Mux-Amp AV = 1

FN7162
Rev 1.00
May 12, 2004

The EL4331 is a triple, very high speed, 2:1 Multiplexing Amplifier. It is intended primarily for component video multiplexing, and is especially suited for pixel switching. The amplifiers have their gain set to 1, internally. All three amplifiers are switched simultaneously from their A to B inputs by the TTL/CMOS compatible, common A/B control pin.

The EL4331 has a power-down mode, in which the total supply current drops to less than 1mA. In this mode, each output will appear as a high impedance.

The EL4331 runs from standard $\pm 5V$ supplies, and is available in the narrow 16-pin small outline package. The package is specified for operation over the full $-40^{\circ}C$ to $+85^{\circ}C$ temperature range.

Pinout

EL4331
(16-PIN SO)
TOP VIEW

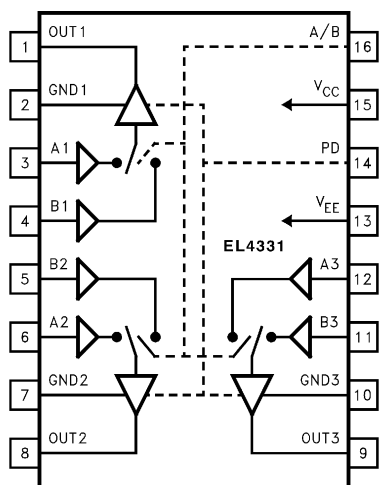

Features

- 3ns A-B switching
- 300MHz bandwidth
- Power-down mode
- TTL/CMOS compatible controls
- Fixed gain of 1
- 400V/ μs slew rate
- Pb-free available

Applications

- RGB multiplexing
- Picture-in-picture
- Cable driving
- HDTV processing
- Switched gain amplifiers
- ADC input multiplexer

Ordering Information

PART NUMBER	PACKAGE	TAPE & REEL	PKG. DWG. #
EL4331CS	16-Pin SO (0.150")	-	MDP0027
EL4331CS-T7	16-Pin SO (0.150")	7"	MDP0027
EL4331CS-T13	16-Pin SO (0.150")	13"	MDP0027
EL4331CSZ (Note)	16-Pin SO (0.150") (Pb-Free)	-	MDP0027
EL4331CSZ-T7 (Note)	16-Pin SO (0.150") (Pb-Free)	7"	MDP0027
EL4331CSZ-T13 (Note)	16-Pin SO (0.150") (Pb-Free)	13"	MDP0027

NOTE: Intersil Pb-free products employ special Pb-free material sets; molding compounds/die attach materials and 100% matte tin plate termination finish, which is compatible with both SnPb and Pb-free soldering operations. Intersil Pb-free products are MSL classified at Pb-free peak reflow temperatures that meet or exceed the Pb-free requirements of IPC/JEDEC J Std-020B.

Absolute Maximum Ratings ($T_A = 25^\circ\text{C}$)

V_{CC} to V_{EE}	14V	Input Current, Any Input	5mA
V_{CC} to Any GND	12V	Power Dissipation	See curves
V_{EE} to Any GND	12V	Ambient Operating Temperature	-40°C to $+85^\circ\text{C}$
Continuous Output Current	45mA	Junction Temperature	150°C
Any Input (except P_D)	$V_{EE}-0.3\text{V}$ to $V_{CC}+0.3\text{V}$	Storage Temperature	-65°C to $+150^\circ\text{C}$
P_D Input	$V_{CC}-7\text{V}$ to $V_{CC}+0.3\text{V}$		

CAUTION: Stresses above those listed in "Absolute Maximum Ratings" may cause permanent damage to the device. This is a stress only rating and operation of the device at these or any other conditions above those indicated in the operational sections of this specification is not implied.

IMPORTANT NOTE: All parameters having Min/Max specifications are guaranteed. Typical values are for information purposes only. Unless otherwise noted, all tests are at the specified temperature and are pulsed tests, therefore: $T_J = T_C = T_A$

DC Electrical Specifications $V_{CC} = +5\text{V}$, $V_{EE} = -5\text{V}$, Ambient Temperature = 25°C , $R_L = 500\Omega$, $P_D = 5\text{V}$

PARAMETER	DESCRIPTION	MIN	TYP	MAX	UNIT
V_{OS}	Input Referred Offset Voltage		-12	30	mV
dV_{OS}	Input A to Input B Offset Voltage (Note 1)		1	8	mV
I_B	Input Bias Current		-7	-30	μA
dI_B	Input A to Input B Bias Current (Note 1)		0.5	4.0	μA
AV_{OL}	Open Loop Gain (from Gain Error Calculation)		54		dB
PSRR	Power Supply Rejection Ratio	60	70		dB
V_{OUT_500}	Output Voltage Swing into 500Ω Load	± 2.7	± 3.2		V
V_{OUT_150}	Output Voltage Swing into 150Ω Load		$+3/-2.7$		V
I_{OUT}	Current Output, Measured with 75Ω load (Note 2)	30	40		mA
X_{TALK}	Crosstalk from Non-Selected Input (at DC)	-70	-85		dB
V_{IH}	Input Logic High Level (A/B and PD)	2.0			V
V_{IL}	Input Logic Low Level (A/B and PD)			0.8	V
I_{IL_AB}	Logic Low Input Current ($V_{IN} = 0.8\text{V}$), A/B Pin	-1	-20	-100	μA
I_{IH_AB}	Logic High Input Current ($V_{IN} = 2.0\text{V}$), A/B Pin	-5	0	5	μA
I_{IL_PD}	Logic Low Input Current ($V_{IN} = 0.8\text{V}$), PD Pin	-10	0	10	μA
I_{IH_PD}	Logic High Input Current ($V_{IN} = 5.0\text{V}$), PD Pin	0.5	1.0	1.6	mA
I_S	Total Supply Current	38	48	60	mA
$I_S(PD)$	Powered Down Supply Current		0.01	1.0	mA

NOTES:

1. Any channel's A-input to its B-input.
2. There is no short circuit protection on any output.

AC Electrical Specifications $V_{CC} = +5\text{V}$, $V_{EE} = -0.5\text{V}$, Ambient Temperature = 25°C , $R_L = 150\Omega$ and $C_L = 5\text{pF}$

PARAMETER	DESCRIPTION	MIN	TYP	MAX	UNIT
BW	-3dB Bandwidth		300		MHz
	-3dB BW with 250Ω and 10pF Load		400		MHz
SR	Slew Rate (4V Square Wave, Measured 25%–75%)		400		$\text{V}/\mu\text{s}$
T_S	Settling Time to 0.1% of Final Value		13		ns
T_{AB}	Time to Switch Inputs		3		ns
OS	Overshoot, $V_{OUT} = 4V_{pk-pk}$		8		%

AC Electrical Specifications $V_{CC} = +5V$, $V_{EE} = -0.5V$, Ambient Temperature = 25°C, $R_L = 150\Omega$ and $C_L = 5pF$ (Continued)

PARAMETER	DESCRIPTION	MIN	TYP	MAX	UNIT
I _{SO-AB-10M}	Input to Input Isolation at 10MHz		53		dB
I _{SO-AB-100M}	Input to Input Isolation at 100MHz		33		dB
I _{SO-CH-10M}	Channel to Channel Isolation at 10MHz		56		dB
I _{SO-CH-CH-100M}	Channel to Channel Isolation at 100MHz		33		dB
P _{kg}	Peaking with Nominal Load		0		dB
T _{ON_PD}	Power-Down Turn-On Time		150		ns
T _{OFF_PD}	Power-Down Turn-Off Time		1		µs

Typical Performance Curves

3dB Bandwidth Small Signal Transmit Response

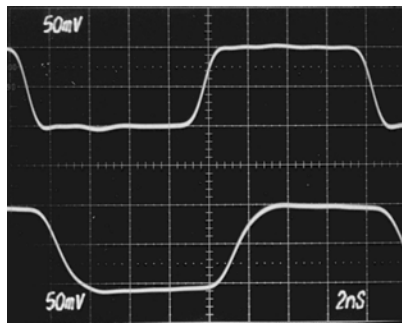

Large Signal Transient Response

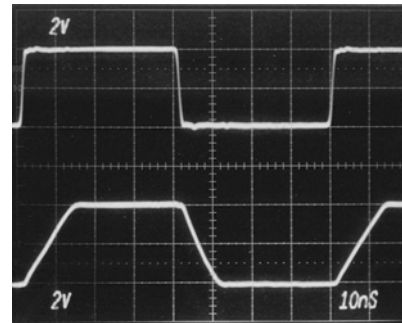

Switching from Ground to An Uncorrelated Sine Wave and Back

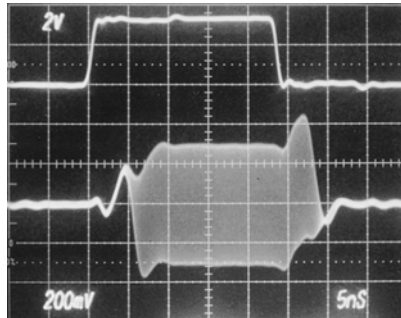

Switching a Family of DC Levels to Ground and Back

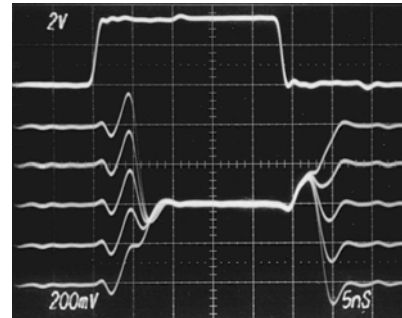

Switching Glitch, 0V to 0V with 2ns AB edges

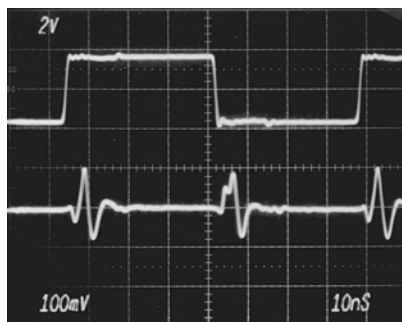

Switching Glitch, 0V to 0V with 10ns AB Edges

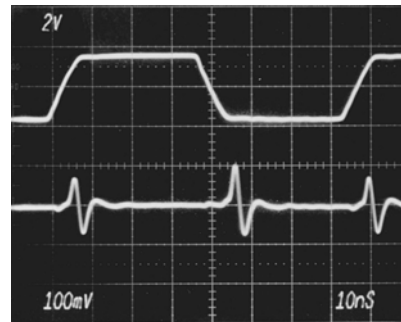

Typical Performance Curves (Continued)

Switching a Family of DC Levels to a Sine Wave and Back

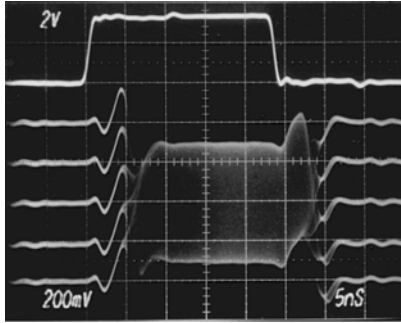

Output Response In and Out of Power-Down with a Family of DC Inputs

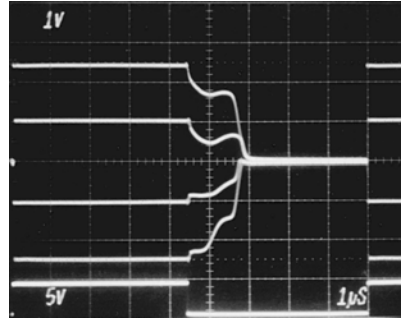

Output Power-Down Turn-Off Response

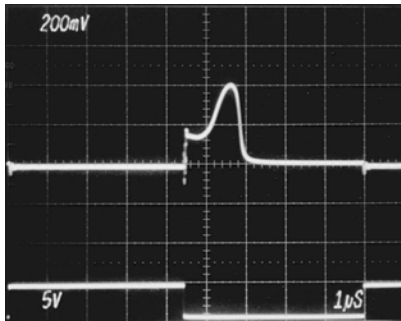

Output Power-Down Turn-On Response

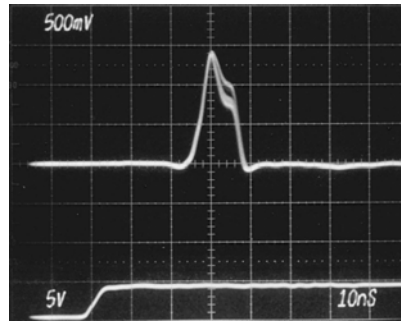

Frequency Response with 150Ω and 5pF Load

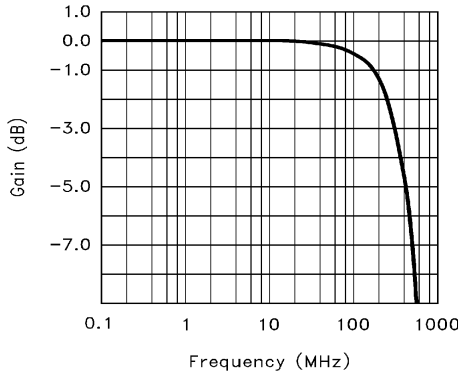

Frequency Response with 240Ω and 5pF Load

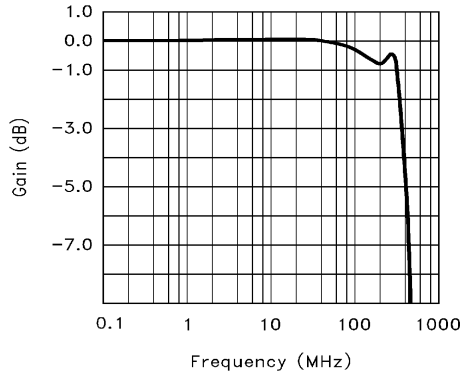

Typical Performance Curves (Continued)

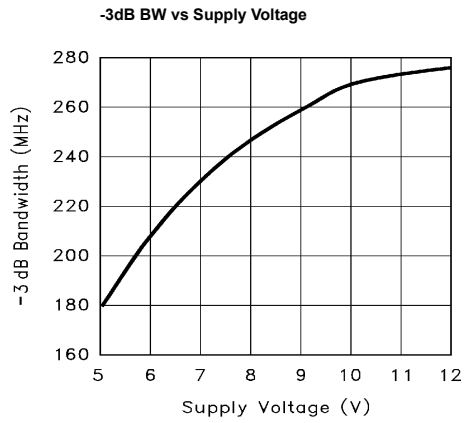
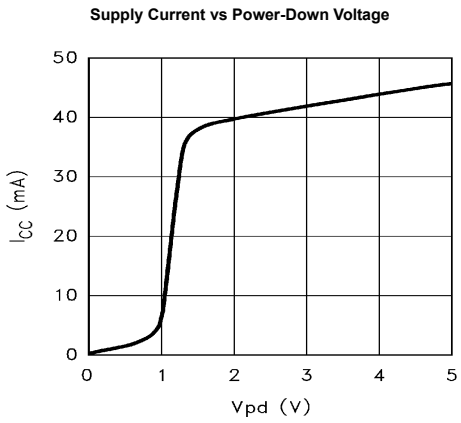
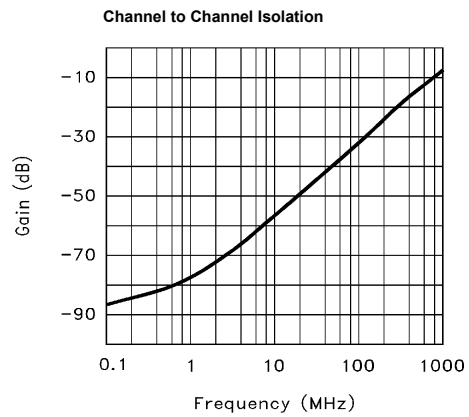
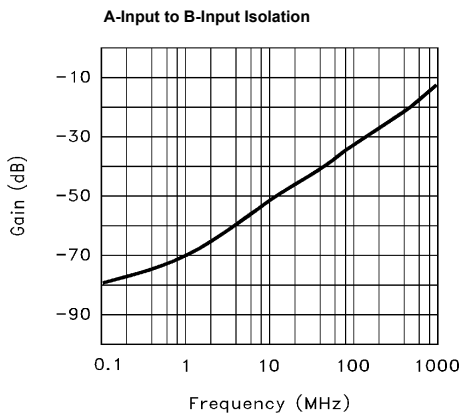
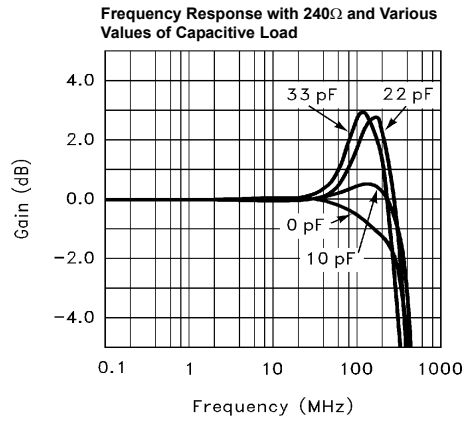
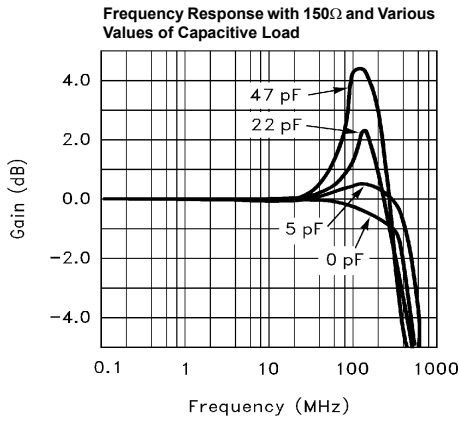

Typical Performance Curves (Continued)

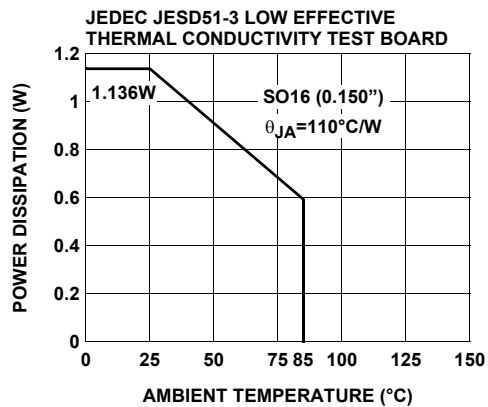
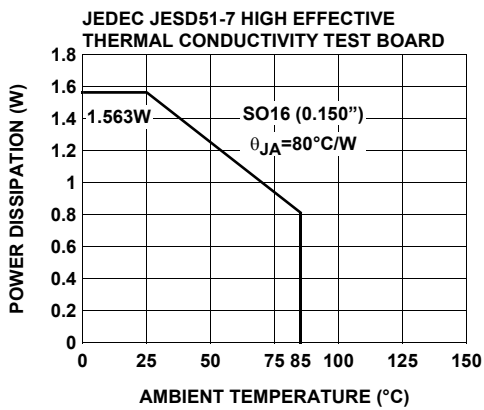
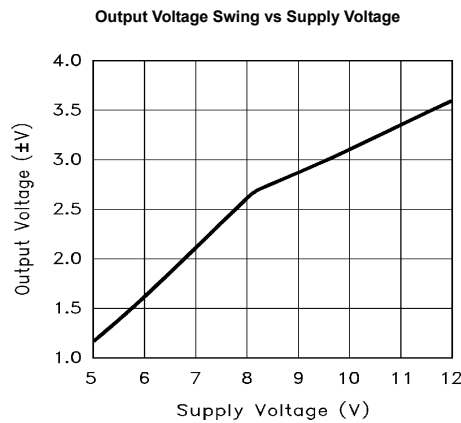
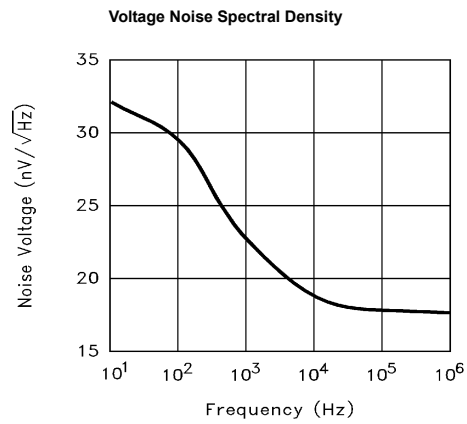
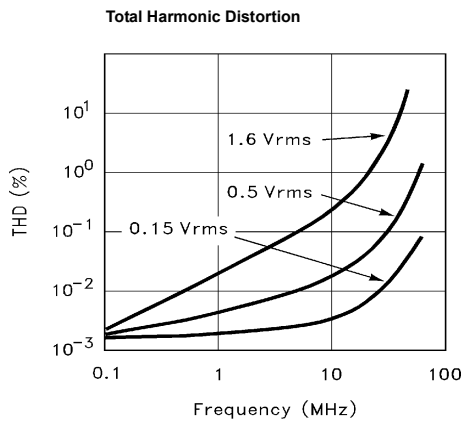
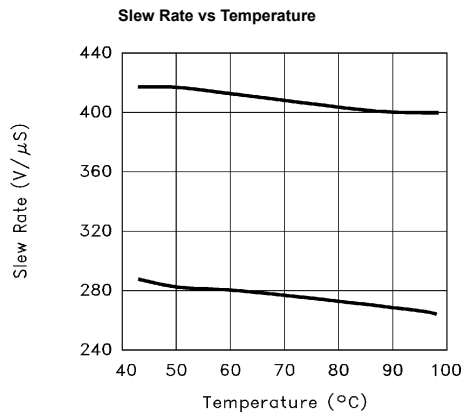
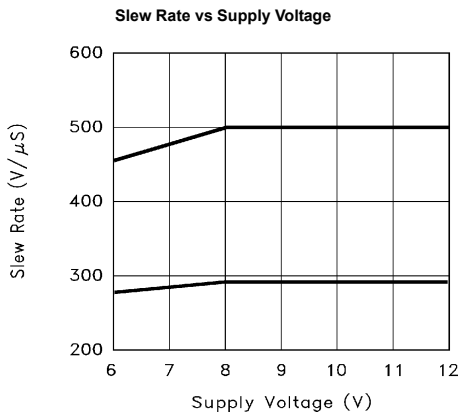

Pin Descriptions

PIN NAME	PIN DESCRIPTION
A1, A2, A3	“A” inputs to amplifiers 1, 2 and 3 respectively
B1, B2, B3	“B” inputs to amplifiers 1, 2 and 3 respectively
GND1, GND2, GND3	These are the individual ground pins for each channel.
OUT1, OUT2, OUT3	Amplifier outputs. Note there is no short circuit protection.
V _{CC}	Positive power supply. Typically +5V.
V _{EE}	Negative power supply, typically -5V.
A/B	Common input select pin, a logic high selects the “A” inputs, logic low selects the “B” inputs. If left to float, this pin will float high and the “A” channels will be selected.
PD	A logic low puts the part into its power-down mode. Note that when this pin is at a logic high (+5V), it will sink typically 1mA. When pulled low, it will source a few μ A, typically < 25 μ A. This pin should not be left floating.

Applications Information

Circuit Operation

Each multiplexing amplifier has two input stages. The multiplexing amplifiers switch from their “A” inputs to their “B” inputs under control of the common **A/B** select pin. The switching has a make before break action. Each amplifier is internally connected for unity gain, allowing larger switching matrixes to be built up. Note however, that each amplifier likes to see a load of 250 Ω or less; load resistances higher than this, can lead to excessive peaking. Load capacitance should be kept down below 40pF, and 40pF requires a load resistance of 150 Ω to keep the output from excessive peaking. Higher capacitive loads can best be driven using a series resistor to isolate the amplifier from the reactive load.

The ground pins are used as a reference for the logic controls. Both **A/B** and **PD** are referenced to ground. The supplies do not have to be symmetrical around ground, but the logic inputs are referred to the ground pins, and the logic swing must not exceed the +V supply. Due to the fact that all three channels share common control pins, the three grounds **have** to be at the same potential. One third of the 1mA that **PD** will sink (at 5V) will be seen at each ground pin. Also, the individual grounds are internally connected to their channel compensation capacitor in an effort to keep crosstalk low.

A/B Switching

Referring to the photographs showing the 0V–0V switching glitches, it will be noted that slower edges on the A/B control pin result in switching glitches of somewhat less total energy. The switching action is a make-before-break, so the two inputs essentially get mixed at the output for a few nanoseconds. Note that the two inputs are buffered, so there is no component of one input injected into the other input. The input impedance does not depend on whether an input has been selected.

Power-Down

Referring to the photographs of the power-down function and Figure 4, it will be noted that there is a considerable glitch in the output as the part powers down. It will also be noted that

the power-down time is considerably longer than power up, 1 μ s compared to 150ns. In power-down mode, the whole amplifier, its reference and bias lines are all powered down. At the same time, the output stage has been configured so that the powered down output appears as a high impedance. This allows circuits such as the multiplexer shown in application #4 to be realized, although the price is the significant output disturbance as one part turns on before the other has fully turned off.

Single Supply Operation

Due to the fact that video signals often have negative sync levels and invariably require ground to be within the signal swing, running the EL4331 on a single supply rail compromises many aspects of its performance. It is difficult to generate a solid, clean, pseudo ground a few volts away from ground without using more power, and components than simply providing a negative power rail. A signal ground has to be capable of handling all the return currents from all the inputs, as well as the outputs, from DC to frequencies in excess of 400MHz. While this is by no means impossible, a negative rail can be generated from a standard +5V rail for a couple of dollars and a square inch, or less, of board space. However, a pseudo ground can be derived with for example an LM336, to give an “AC ground” 2.5V above 0V. The logic inputs will need some form of level shifting to ensure that the logic “1” and “0” specifications can be met. The pseudo ground must be well bypassed to the real ground; note that the pseudo ground will have to sink/source all the current that flows in the internal compensation capacitors during slewing. This can easily be several milliamps in a few nanoseconds. If the pseudo ground “moves” because one channel is forcing current into the derived ground, cross-talk into the other two channels will become very significant.

Application Circuit #1

Figure 1 shows a very high speed RGB (or YUV) multiplexer. Two video sources can be displayed on one monitor with the only stipulation that the video sources have to be synchronous. An example is a picture-in-picture, or “window” is generated

with one video source (e.g. RGB TV) in a window, and a computer application around it. Multiplexing synchronous RGB signals has the advantage that the video signals do not have to be digitized, and an image stored in RAM prior to being displayed.

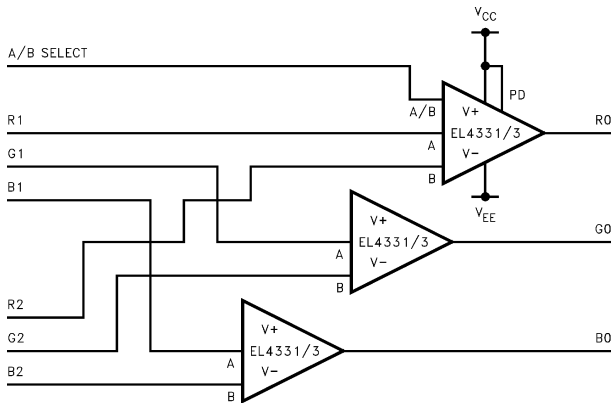

FIGURE 1. TWO RGB SOURCES MULTIPLEXED TO ONE RGB OUTPUT

When the monitor is switched off, or goes into its power-saving blanked mode, the EL4331 can be powered down to further save power. The input impedance does not change appreciably between powered up and down modes, although the bias current does drop to near zero.

A demonstration board with this circuit on it is available from Elantec.

Application Circuit #2

Figure 2 shows a circuit that has either a very wide bandwidth, or an 11MHz low pass response. The EL4331's "A" inputs are connected to the one frequency determining set of components, while the "B" inputs are connected directly. The A/B select pin therefore selects the desired bandwidth. This would allow appropriate filtering to clean up noisy low bandwidth video signals when displaying them on a high quality wide bandwidth monitor.

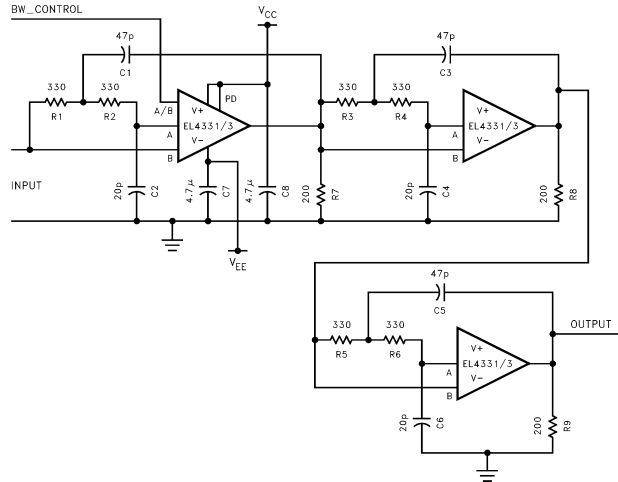

FIGURE 2. A BANDWIDTH-SELECTABLE FILTER

Application Circuit #3

Figure 3 shows one of the three channels of a component video, 8:1 multiplexer. The A/B select pins naturally allow binary coded addressing—allowing simple microprocessor or state machine control. Note that each amplifier output is loaded, to keep the amplifier outputs damped.

Photograph A1 shows a staircase generated by having all the inputs (sig0 through sig7) connected to a resistive divider chain, and the select bits were driven by a binary counter. Photograph A2 shows the glitch between steps 4 and 5; this is the worst glitch since all three banks of EL4331s are switching together. The magnitude of this glitch is affected by the timing skew of the select lines, the physical length of the traces, and the difference in amplitude of the two signals. This particular circuit was bread-boarded using EL4331s on their adapter boards (available from Elantec for those who can not breadboard with SOICs), and the binary counter was an 'LS163.

Note: No supply bypass capacitors shown and only one of three channels shown.

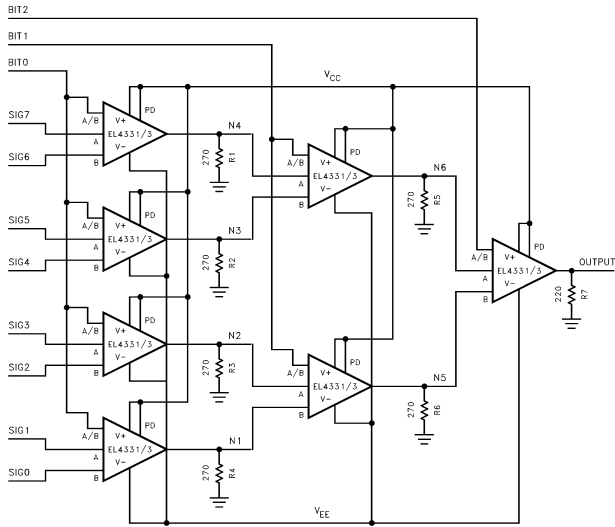
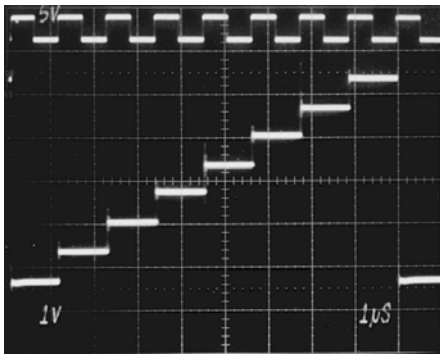

TABLE 1. CHANNEL SELECTION TABLE

BIT2	BIT1	BIT0	OUTPUT
0	0	0	SIG0
0	0	1	SIG1
0	1	0	SIG2
0	1	1	SIG3
1	0	0	SIG4
1	0	1	SIG5
1	1	0	SIG6
1	1	1	SIG7

FIGURE 3. A HIGH SPEED, 8:1 COMPONENT VIDEO MULTIPLEXER



PHOTOGRAPH A1

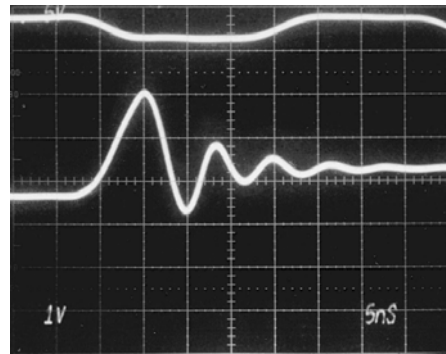

PHOTOGRAPH A2

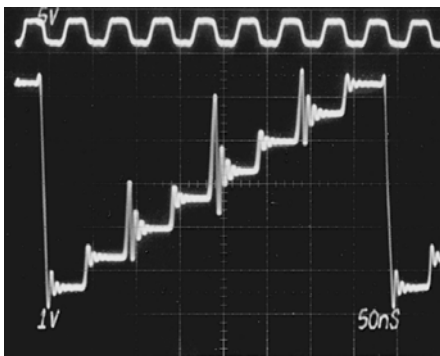

PHOTOGRAPH A3

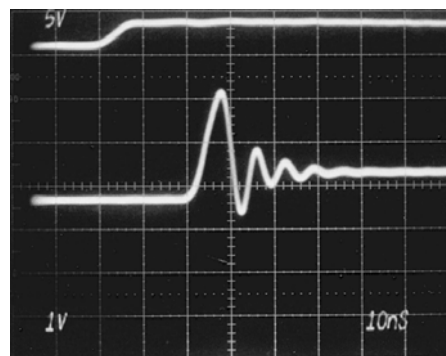

PHOTOGRAPH A4

Photograph A3 shows the same circuit, with the counter running at 25MHz. This turns out to be close to the limit of the TTL counter used in the breadboard, rather than the limit of the EL4331. Here the different glitches are easily recognizable - a small glitch for one of the 4 input EL4331s A/B switching, somewhat larger glitches when two banks switch together, and the biggest glitch when all three banks switch. Photograph A4 shows the big glitch in detail. A good PCB and equal length and matched traces would clean up these glitches.

Note: No supply bypass capacitors shown. Only one of three channels shown.

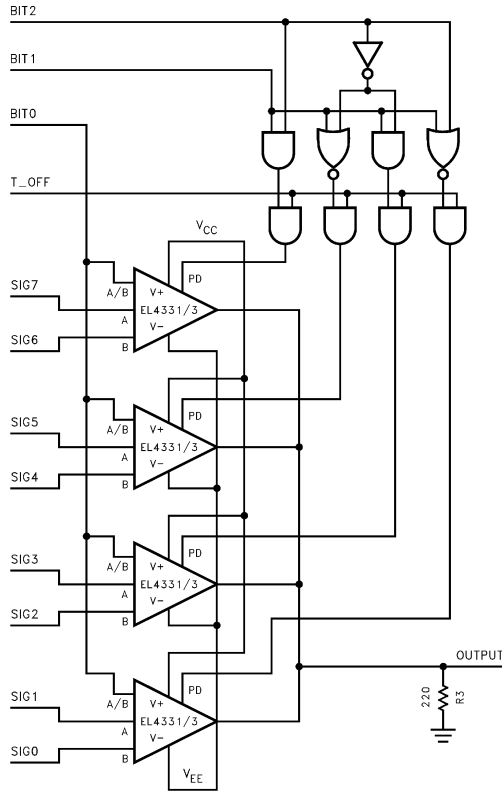

8-to-1 Multiplexer using Power-Down

FIGURE 4. A SIMPLE 8:1 COMPONENT VIDEO MULTIPLEXER

TABLE 2. CHANNEL SELECTION TABLE

BIT2	BIT1	BIT0	OUTPUT
0	0	0	SIG0
0	0	1	SIG1
0	1	0	SIG2
0	1	1	SIG3
1	0	0	SIG4
1	0	1	SIG5
1	1	0	SIG6
1	1	1	SIG7

Figure 4 shows one of the three channels of a component video, 8:1 multiplexer. In this example, the power-down capability is used to save on EL4331s, but as can be seen, the control part does become more complicated. Using the power-down mode for multiplexing does, of course, slow down the speed with which one can select a given input channel. However, if input channel selection can be done during a blanking period, the couple of microseconds that it takes to power-down one chip may be no problem. Note that some external logic is needed in this application, both to select the appropriate amplifier, and also to force a break-before-make action by pulling the T_OFF line low. All this logic would best be incorporated inside a PAL or gate array, and is shown in gate form just to illustrate the idea. Note that the BIT0 line would have the 3ns response time, since it is switching the muxamps directly.

© Copyright Intersil Americas LLC 2003. All Rights Reserved.

All trademarks and registered trademarks are the property of their respective owners.

For additional products, see www.intersil.com/en/products.html

Intersil products are manufactured, assembled and tested utilizing ISO9001 quality systems as noted in the quality certifications found at www.intersil.com/en/support/qualandreliability.html

Intersil products are sold by description only. Intersil may modify the circuit design and/or specifications of products at any time without notice, provided that such modification does not, in Intersil's sole judgment, affect the form, fit or function of the product. Accordingly, the reader is cautioned to verify that datasheets are current before placing orders. Information furnished by Intersil is believed to be accurate and reliable. However, no responsibility is assumed by Intersil or its subsidiaries for its use; nor for any infringements of patents or other rights of third parties which may result from its use. No license is granted by implication or otherwise under any patent or patent rights of Intersil or its subsidiaries.

For information regarding Intersil Corporation and its products, see www.intersil.com