

**Triple 80MHz Video Amplifier w/Disable**



The EL4393 is three wideband current-feedback amplifiers optimized for video performance. Each amplifier can drive

a load of 150Ω at video levels. Each amplifier has a disable capability, which is controlled by a TTL/CMOS compatible logic signal. The EL4393 operates on supplies as low as ±4V up to ±15V.

Being a current-feedback design, the bandwidth stays relatively constant at approximately 80MHz over the ±1 to ±10 gain range. The EL4393 has been optimized for use with 1300Ω feedback resistors at a gain of 2.

When the outputs are disabled, the supply current consumption drops, by about 4mA per channel that is disabled. This feature can be used to reduce power dissipation.

**Pinout**

**EL4393  
(16-PIN PDIP, SO)  
TOP VIEW**

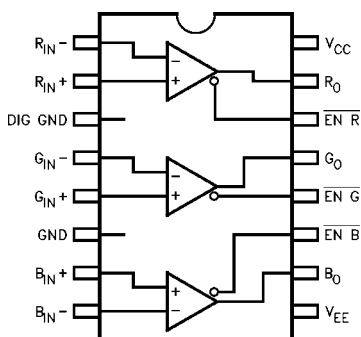

**Features**

- 80MHz -3dB bandwidth for gains of 1 to 10
- 900V/μs slew rate
- 10MHz bandwidth flat to 0.1dB
- Excellent differential gain and phase
- TTL/CMOS compatible
- Available in SOL-16

**Applications**

- RGB drivers
- RGB multiplexers
- RGB gain blocks
- Video gain blocks
- Coax cable driver
- ADC drivers/input multiplexer

**Ordering Information**

PART NUMBER	TEMP. RANGE	PACKAGE	PKG. NO.
EL4393CN	-40°C to +85°C	16-Pin PDIP	MDP0031
EL4393CM	-40°C to +85°C	16-Pin SOL	MDP0027

**Absolute Maximum Ratings** ( $T_A = 25^\circ\text{C}$ )

Voltage between $V_{S+}$ and $V_{S-}$ .....	+33V	Internal Power Dissipation.....	See Curves
Voltage at $V_{S+}$ .....	+18V	Operating Ambient Temperature Range.....	-40°C to +85°C
Voltage at $V_{S-}$ .....	-18V	Operating Junction Temperature.....	150°C
Voltage between $V_{IN+}$ and $V_{IN-}$ .....	±6V	Storage Temperature Range.....	-65°C to +150°C
Current into $V_{IN+}$ or $V_{IN-}$ .....	5mA		

*CAUTION: Stresses above those listed in "Absolute Maximum Ratings" may cause permanent damage to the device. This is a stress only rating and operation of the device at these or any other conditions above those indicated in the operational sections of this specification is not implied.*

*IMPORTANT NOTE: All parameters having Min/Max specifications are guaranteed. Typical values are for information purposes only. Unless otherwise noted, all tests are at the specified temperature and are pulsed tests, therefore:  $T_J = T_C = T_A$*

**Open-Loop DC Electrical Specifications**      Supplies at ±15V, Load = 1kΩ

PARAMETER	DESCRIPTION	TEMP	MIN	TYP	MAX	UNITS
$V_{OS}$	Input Offset Voltage	+25°C		2	±15	mV
$TCV_{OS}$	Temperature Coefficient of $V_{OS}$	Full		50		µV/°C
$I_{B+}$	$I_{IN+}$ Input Bias Current	+25°C		0.2	5	µA
$I_{B-}$	$I_{IN-}$ Input Bias Current	+25°C		10	65	µA
$TCI_{B-}$	Temperature Coefficient of $I_{B-}$	Full		25		nA/°C
CMRR	Common-Mode Rejection Ratio (Note 1)	+25°C	50	58		dB
-ICMR	$I_{IN-}$ Input Common-Mode Current (Note 1)	+25°C		3	8	µA/V
PSRR	Power Supply Rejection Ratio (Note 2)	+25°C	50	58		dB
-IPSR	$I_{IN-}$ Current Supply Rejection (Note 2)	+25°C		2	5	µA/V
$R_{OL}$	Transimpedance	+25°C	100	217		kΩ
$R_{IN}$	IN+ Input Impedance	+25°C		2		MΩ
$V_{IN}$	IN+ Input Range	+25°C	±13	±13.5		V
$V_O$	Output Voltage Swing; $R_L = 1k\Omega$	+25°C	±12	±13		V
$I_{SC}$	Short-Circuit Current (Note 3)	+25°C	40	70		mA
$I_{O, DIS}$	Output Current when Disabled	+25°C		5	150	µA
DIS $V_{IL}$	Disable Voltage for Logic Low	+25°C			0.8	V
DIS $V_{IH}$	Disable Voltage for Logic High	+25°C	2.2			V
DIS $I_{IL}$	Disable Logic Low Input Current	+25°C		3	25	µA
DIS $I_{IH}$	Disable Logic High Input Current	+25°C		0	5	µA
$I_{CC} (en)$	Positive Supply Current all Channels Enabled	+25°C	15	20	±29	mA
$I_{CC} (dis)$	Positive Supply Current all Channels Disabled	+25°C	6	11	16	mA
$I_{EE} (en)$	Negative Supply Current all Channels Enabled	+25°C	13	18	±28	mA
$I_{EE} (dis)$	Negative Supply Current all Channels Disabled	+25°C	4	9	14	mA

NOTES:

- $V_{CM} = \pm 10V$  for  $V_S = \pm 15V$ .
- $V_{OS}$  is measured at  $V_S = \pm 4.5V$  and  $V_S = \pm 16V$ , both supplies are changed simultaneously.
- Only one output short-circuited. Pulse test or use heatsink.

**AC Electrical Specifications** Supplies at  $\pm 15V$ , Load =  $150\Omega$  and  $15pF$ , except where noted.  $R_{f1}$  and  $R_{f2} = 1500\Omega$ ;  $A_V = 2$ ,  $T_A = 25^\circ C$ .(Note 1)

PARAMETER	DESCRIPTION	MIN	TYP	MAX	UNITS
SR	Slew Rate (Note 2)		960		V/ $\mu s$
SR	Slew Rate w/ $\pm 5V$ Supplies (Note 3)		470		V/ $\mu s$
$t_s$	Settling Time to 1% $5V_{P-P}$ 5V Step (Note 4)		32		ns
BW	Bandwidth, -3dB $\pm 5V$ Supplies, -3dB		80 60		MHz MHz
BW	Bandwidth, -0.1dB $\pm 5V$ Supplies, -0.1dB		16 21		MHz MHz
Peaking	-3dB BW Tests		0.6		dB
dG	Differential Gain at 3.58MHz at $\pm 5V$ Supplies (Note 5)		0.03 0.30		% %
d $\theta$	Differential Phase at 3.58MHz at $\pm 5V$ Supplies (Note 5)		0.088 0.096		( $^\circ$ ) ( $^\circ$ )

NOTES:

1. Test fixture was designed to minimize capacitance at the  $I_{N+}$  input. A "good" fixture should have less than  $2pF$  of stray capacitance to ground at this very sensitive pin. See application notes for further details.
2.  $R_L = 300\Omega$ , -5V to +5V swing, SR measured at 20% to 80%
3. -2V to +2V swing, SR measured at 20% to 80%.
4.  $R_L = 300\Omega$ .
5. DC offset from -0.7V through +0.7V AC amplitude is  $286mV_{P-P}$ , equivalent to 40 ire.

Typical Performance Curves

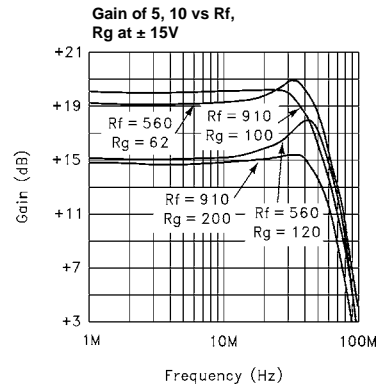
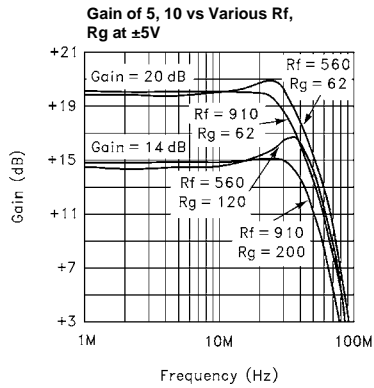
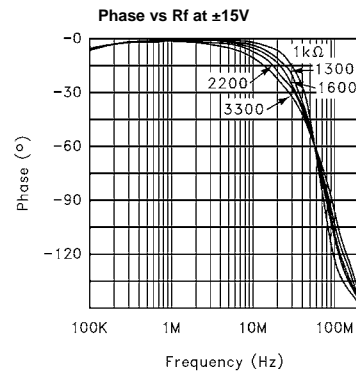
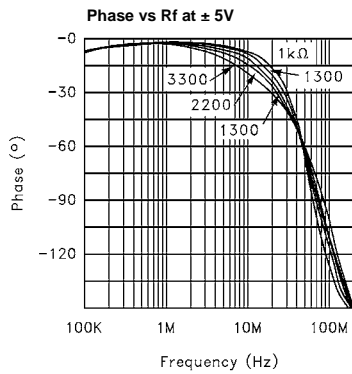
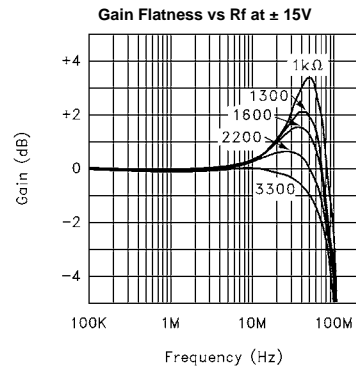
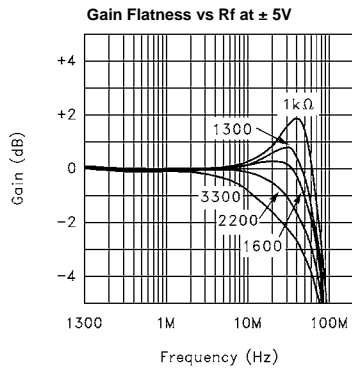

Typical Performance Curves (Continued)

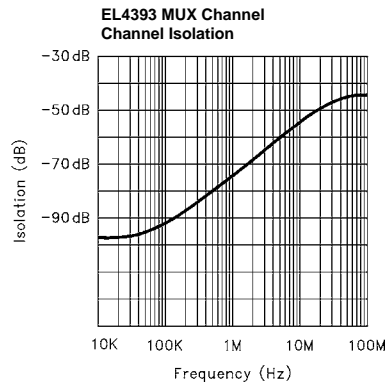
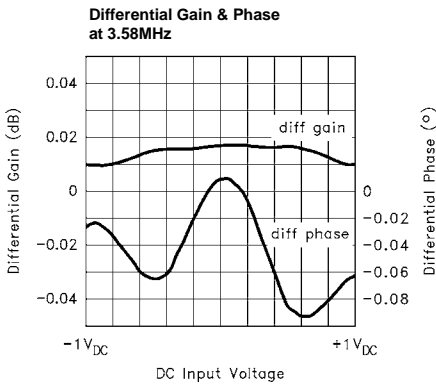
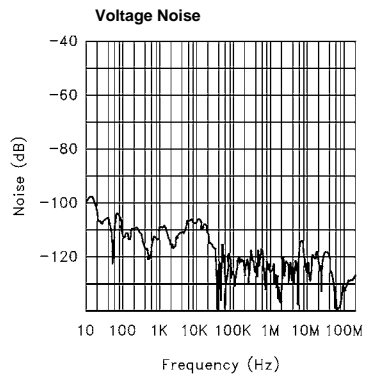
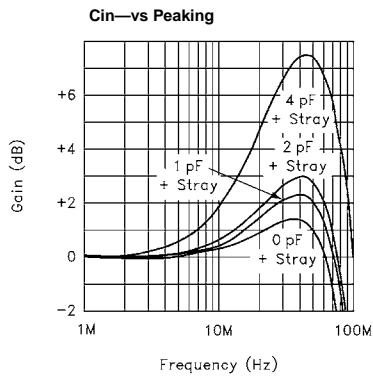
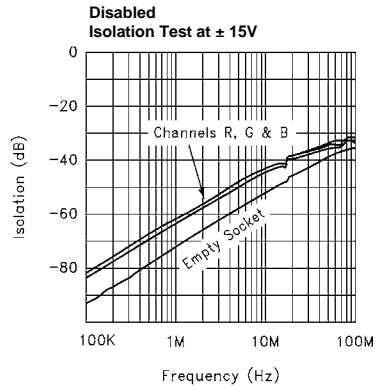
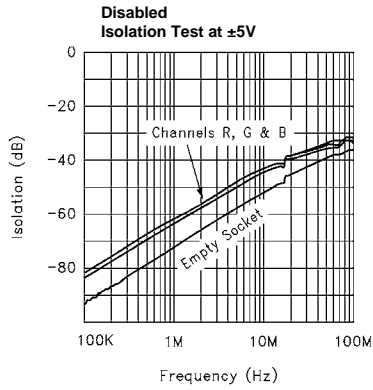

Typical Performance Curves (Continued)

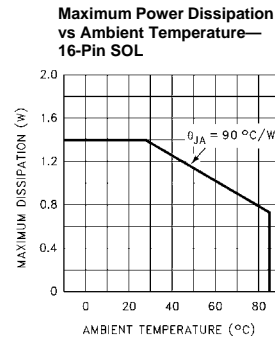
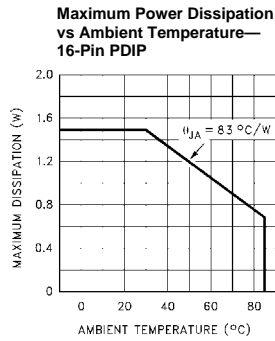
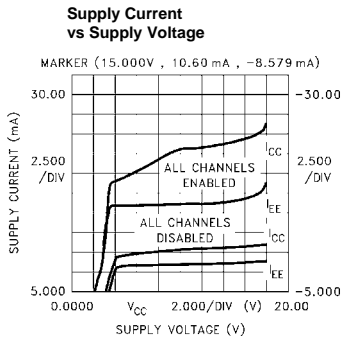

Small Signal Pulse Response

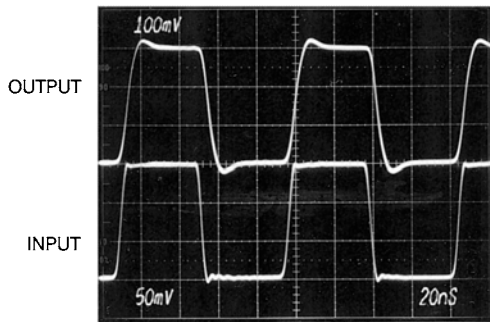

Large Signal Pulse Response

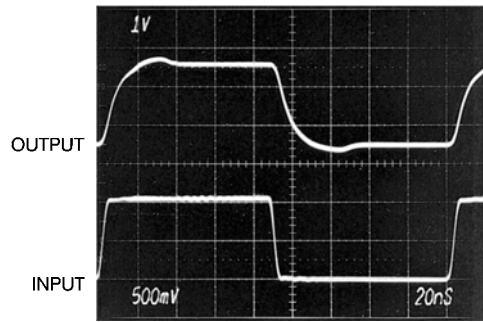

Small Signal Enable/Disable with +VE Voltage

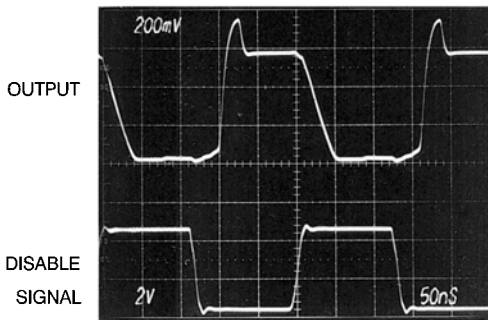

Enable/Disable with -VE Voltage Output

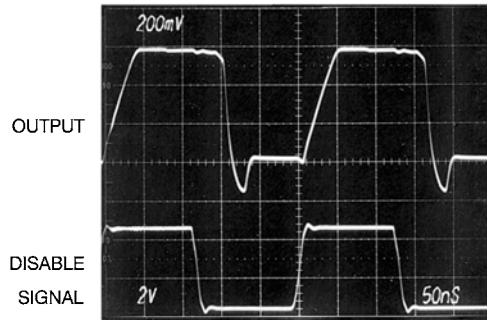

Typical Application for EL4393, and General Rules for PCB Layout

The figure shows two EL4393s configured as a 2:1 RGB multiplexer, and cable driver, driving 75Ω, back terminated cables. Each channel of the EL4393 is configured to give a gain of two, to make up for the losses of the back terminating resistor.

In this example, the Disable pins of each RGB section are driven by a complementary TTL “select” signal. Larger multiplexers can be assembled, with a 1-of-n TTL decoder selecting each RGB triplet.

The circuit gives channel isolations of typically better than -50dB at 10MHz, and with a 20dB/decade slope, extending down to better than -90dB at frequencies below 100kHz.

The schematic does not show things like power supply decoupling, or pcb layout, grounding and signal returns, but these will all affect the overall performance of the circuit, and care should be taken with these aspects.

It is recommended that the  $V_{CC}$  and  $V_{EE}$  pins each be decoupled by a 0.1μF NPO or X7R dielectric ceramic capacitors to ground within 0.1 inch of the part, and in parallel with the 0.1μF, a 47μF tantalum capacitor, also to ground. The 47μF capacitors should be within 0.25 inch of their power

pins. The ground plane should be underneath the package, but cut away from the In- inputs. Care should be taken with the center channel feedback—it must be kept away from any of the In+ or In- pins, if it has to go under the package. Route the G-out line between the pin 3 ground and the pin 4 In- if going under the package is essential. Otherwise, loop the G-out trace around all the other circuitry, to its Rf resistor. The

Rf and if used, Rg resistors should be on the input side of the package, to minimize trace length on the In- pins.

The digital input disables are on the output side of the package, so that a good ground plane down the center of the board underneath the package will isolate any fast edges from the sensitive inputs.

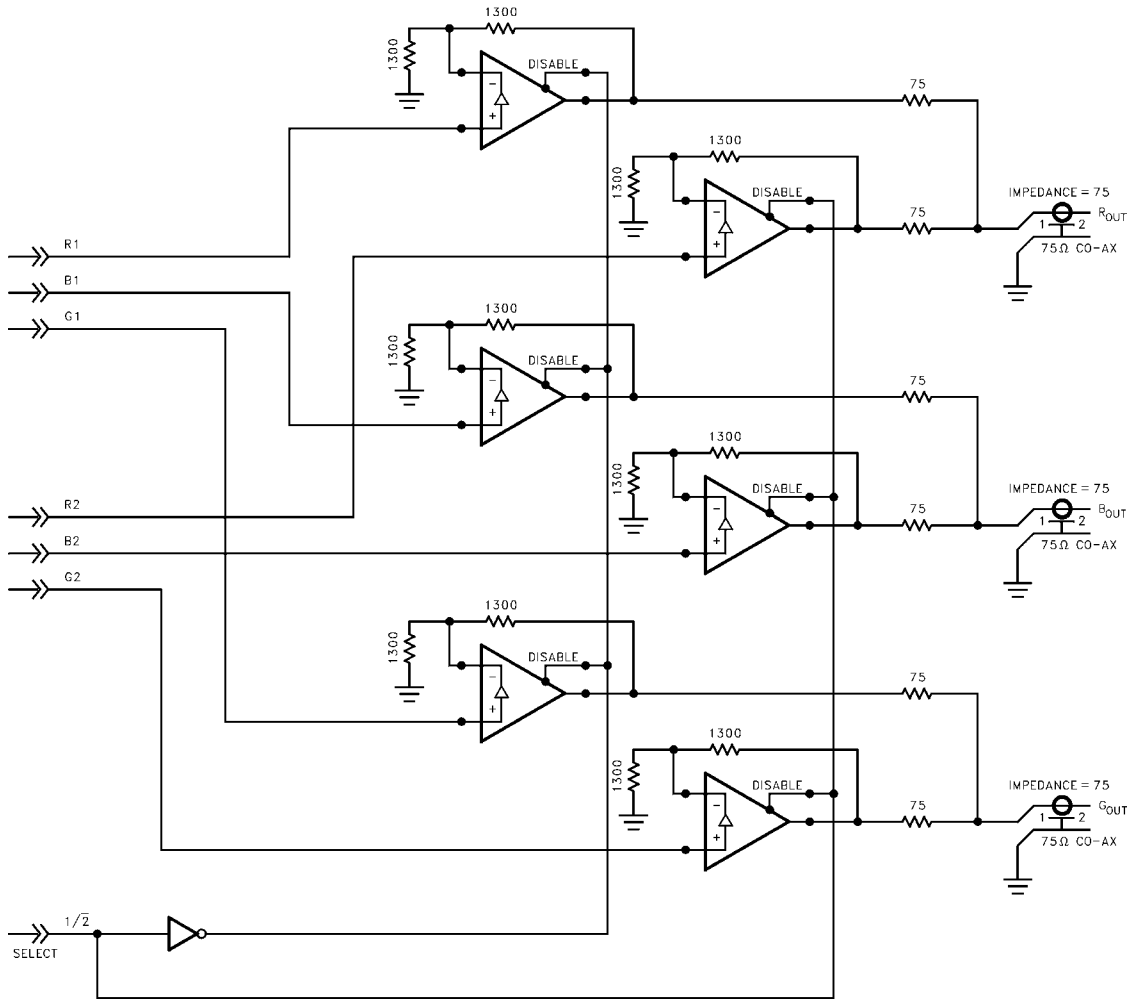

TYPICAL APPLICATION CIRCUIT

**EL4393 Macromodel**

\* Revision A, July 1993

\* Enhancements include PSRR, CMRR, and Slew Rate Limiting

```

* Connections:      +input
*                   |
*                   | -Input
*                   |
*                   | +Vsupply
*                   | |
*                   | | -Vsupply
*                   | | |
*                   | | | Putput
*                   | | | |
* subckt EL4393/EL 3 2 7 4 6

```

\* Input Stage

```

*
e1 10 0 3 0 1.0
vis 10 9 0V
h2 9 12 vxx 1.0
r1 2 11 50
l 1 11 12 29 nH
iinp 3 0 0.2 μA
iinm 2 0 10 μA

```

\* Slew Rate Limiting

```

*
h1 13 0 vis 600
r2 13 14 1K
d1 14 0 dclamp
d2 0 14 dclamp

```

\* High Frequency Pole

```

*
e2 30 0 14 0 0.00166666666
l5 30 17 1.2 μH
c5 17 0 1 pF
r5 17 0 500

```

\* Transimpedance Stage

```

*
g1 0 18 17 0 1.0
rol 18 0 250k
cdp 18 0 2.2 pF

```

\* Output Stage

```

*
q1 4 18 19 qp
q2 7 18 20 qn
q3 7 19 21 qn
q4 4 20 22 qp
r7 21 6 4
r8 22 6 4
ios1 7 19 2.5 mA
ios2 20 4 2.5 mA

```

\* Error Terms

```

*
ivos 0 23 2 mA
vxx 23 0 0V
e4 24 0 3 0 1.0
e5 25 0 7 0 1.0
e6 26 0 4 0 1.0
r9 24 23 1K

```



# EL4393

r10 25 23 1K

r11 26 33 1K

\*

\* Models

\*

.model qn npn (is=5e-15 bf=100 tf=0.2nS)

.model qp pnp (is=5e-15 bf=100 tf=0.2nS)

.model dclamp d (is=1e-30 ibv=0.266 bv=1.5 n=4)

.ends

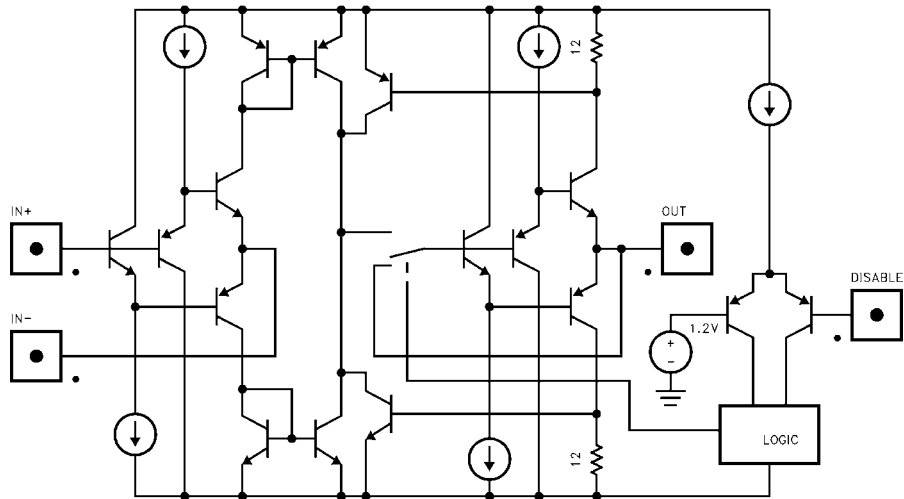
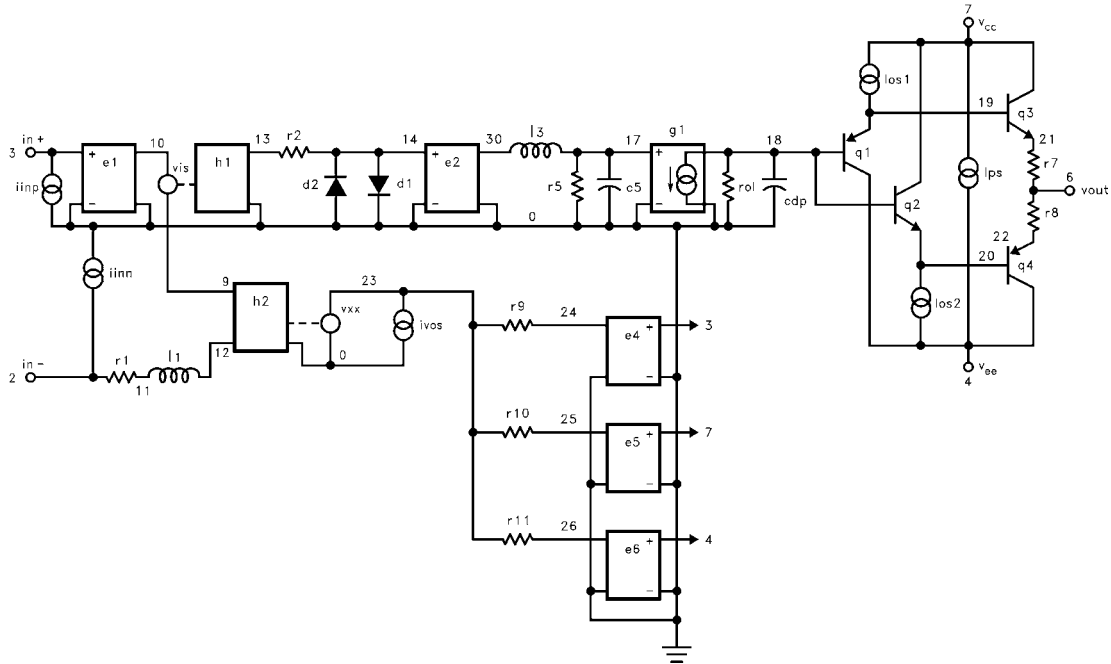

**SIMPLIFIED SCHEMATIC OF ONE CHANNEL OF EL4393**

All Intersil U.S. products are manufactured, assembled and tested utilizing ISO9000 quality systems.

Intersil Corporation's quality certifications can be viewed at [www.intersil.com/design/quality](http://www.intersil.com/design/quality)

*Intersil products are sold by description only. Intersil Corporation reserves the right to make changes in circuit design, software and/or specifications at any time without notice. Accordingly, the reader is cautioned to verify that data sheets are current before placing orders. Information furnished by Intersil is believed to be accurate and reliable. However, no responsibility is assumed by Intersil or its subsidiaries for its use; nor for any infringements of patents or other rights of third parties which may result from its use. No license is granted by implication or otherwise under any patent or patent rights of Intersil or its subsidiaries.*

For information regarding Intersil Corporation and its products, see [www.intersil.com](http://www.intersil.com)