

## Features

- 30MHz -3dB bandwidth
- Supply voltage = 4.5V to 16.5V
- Low supply current (per amplifier) = 2.5mA
- High slew rate = 33V/μs
- Unity-gain stable
- Beyond the rails input capability
- Rail-to-rail output swing
- Available in both standard and space-saving fine pitch packages

## Applications

- Driver for A-to-D Converters
- Data Acquisition
- Video Processing
- Audio Processing
- Active Filters
- Test Equipment
- Battery Powered Applications
- Portable Equipment

## Ordering Information

Part No.	Package	Tape & Reel	Outline #
EL5210CS	8-Pin SOIC	-	MDP0027
EL5210CS-T13	8-Pin SOIC	13"	MDP0027
EL5210CY	8-Pin MSOP	-	MDP0043
EL5210CY-T7	8-Pin MSOP	7"	MDP0043
EL5210CY-T13	8-Pin MSOP	13"	MDP0043
EL5410CS	14-Pin SOIC	-	MDP0027
EL5410CS-T13	14-Pin SOIC	13"	MDP0027
EL5410CR	14-Pin TSSOP	-	MDP0044
EL5410CR-T13	14-Pin TSSOP	13"	MDP0044

## General Description

The EL5210C and EL5410C are low power, high voltage rail-to-rail input-output amplifiers. The EL5210C contains two amplifiers in one package and the EL5410C contains four amplifiers. Operating on supplies ranging from 5V to 15V, while consuming only 2.5mA per amplifier, the EL5410C and EL5210C have a bandwidth of 30MHz (-3dB). They also provide common mode input ability beyond the supply rails, as well as rail-to-rail output capability. This enables these amplifiers to offer maximum dynamic range at any supply voltage.

The EL5410C and EL5210C also feature fast slewing and settling times, as well as a high output drive capability of 30mA (sink and source). These features make these amplifiers ideal for high speed filtering and signal conditioning application. Other applications include battery power, portable devices, and anywhere low power consumption is important.

The EL5410C is available in a space-saving 14-Pin TSSOP package, as well as the industry-standard 14-Pin SOIC. The EL5210C is available in the 8-Pin MSOP and 8-Pin SOIC packages. Both feature a standard operational amplifier pin out. These amplifiers operate over a temperature range of -40°C to +85°C.

## Connection Diagram

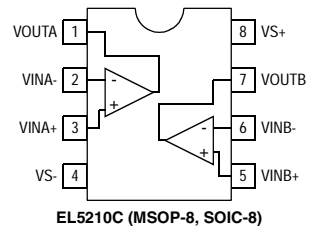
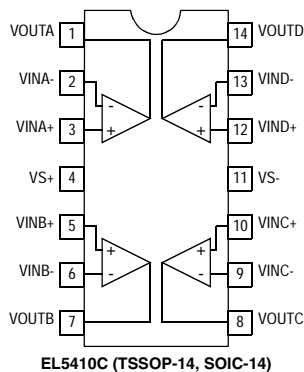

# EL5210C/EL5410C

## 30MHz Rail-to-Rail Input-Output Op Amps

### Absolute Maximum Ratings (T<sub>A</sub> = 25°C)

Values beyond absolute maximum ratings can cause the device to be prematurely damaged. Absolute maximum ratings are stress ratings only and functional device operation is not implied.

Supply Voltage between V <sub>S+</sub> and V <sub>S-</sub>	+18V
Input Voltage	V <sub>S-</sub> - 0.5V, V <sub>S</sub> +0.5V
Maximum Continuous Output Current	30mA

Maximum Die Temperature	+125°C
Storage Temperature	-65°C to +150°C
Operating Temperature	-40°C to +85°C
Power Dissipation	See Curves
ESD Voltage	2kV

#### Important Note:

All parameters having Min/Max specifications are guaranteed. Typ values are for information purposes only. Unless otherwise noted, all tests are at the specified temperature and are pulsed tests, therefore: T<sub>J</sub> = T<sub>C</sub> = T<sub>A</sub>

### Electrical Characteristics

V<sub>S+</sub> = +5V, V<sub>S-</sub> = -5V, R<sub>L</sub> = 1kΩ and C<sub>L</sub> = 12pF to 0V, T<sub>A</sub> = 25°C unless otherwise specified.

Parameter	Description	Condition	Min	Typ	Max	Unit
<b>Input Characteristics</b>						
V <sub>OS</sub>	Input Offset Voltage	V <sub>CM</sub> = 0V		3	15	mV
TCV <sub>OS</sub>	Average Offset Voltage Drift <sup>[1]</sup>			7		μV/°C
I <sub>B</sub>	Input Bias Current	V <sub>CM</sub> = 0V		2	60	nA
R <sub>IN</sub>	Input Impedance			1		GΩ
C <sub>IN</sub>	Input Capacitance			2		pF
CMIR	Common-Mode Input Range		-5.5		+5.5	V
CMRR	Common-Mode Rejection Ratio	for V <sub>IN</sub> from -5.5V to 5.5V	50	70		dB
A <sub>VOL</sub>	Open-Loop Gain	-4.5V ≤ V <sub>OUT</sub> ≤ 4.5V	65	80		dB
<b>Output Characteristics</b>						
V <sub>OL</sub>	Output Swing Low	I <sub>L</sub> = -5mA		-4.9	-4.8	V
V <sub>OH</sub>	Output Swing High	I <sub>L</sub> = 5mA	4.8	4.9		V
I <sub>SC</sub>	Short Circuit Current			±120		mA
I <sub>OUT</sub>	Output Current			±30		mA
<b>Power Supply Performance</b>						
PSRR	Power Supply Rejection Ratio	V <sub>S</sub> is moved from ±2.25V to ±7.75V	60	80		dB
I <sub>S</sub>	Supply Current (Per Amplifier)	No Load		2.5	3.75	mA
<b>Dynamic Performance</b>						
SR	Slew Rate <sup>[2]</sup>	-4.0V ≤ V <sub>OUT</sub> ≤ 4.0V, 20% o 80%		33		V/μs
t <sub>s</sub>	Settling to +0.1% (A <sub>V</sub> = +1)	(A <sub>V</sub> = +1), V <sub>O</sub> = 2V Step		140		ns
BW	-3dB Bandwidth			30		MHz
GBWP	Gain-Bandwidth Product			20		MHz
PM	Phase Margin			50		°
CS	Channel Separation	f = 5MHz		110		dB
d <sub>G</sub>	Differential Gain <sup>[3]</sup>	R <sub>F</sub> = R <sub>G</sub> = 1kΩ and V <sub>OUT</sub> = 1.4V		0.12		%
d <sub>P</sub>	Differential Phase <sup>[3]</sup>	R <sub>F</sub> = R <sub>G</sub> = 1kΩ and V <sub>OUT</sub> = 1.4V		0.17		°

1. Measured over operating temperature range
2. Slew rate is measured on rising and falling edges
3. NTSC signal generator used

# EL5210C/EL5410C

## 30MHz Rail-to-Rail Input-Output Op Amps

EL5210C/EL5410C

### Electrical Characteristics

$V_{S+} = 5V$ ,  $V_{S-} = 0V$ ,  $R_L = 1k\Omega$  and  $C_L = 12pF$  to 2.5V,  $T_A = 25^\circ C$  unless otherwise specified.

Parameter	Description	Condition	Min	Typ	Max	Unit
<b>Input Characteristics</b>						
$V_{OS}$	Input Offset Voltage	$V_{CM} = 2.5V$		3	15	mV
$TCV_{OS}$	Average Offset Voltage Drift <sup>[1]</sup>			7		$\mu V/^\circ C$
$I_B$	Input Bias Current	$V_{CM} = 2.5V$		2	60	nA
$R_{IN}$	Input Impedance			1		$G\Omega$
$C_{IN}$	Input Capacitance			2		pF
CMIR	Common-Mode Input Range		-0.5		+5.5	V
CMRR	Common-Mode Rejection Ratio	for $V_{IN}$ from -0.5V to 5.5V	45	66		dB
$A_{VOL}$	Open-Loop Gain	$0.5V \leq V_{OUT} \leq 4.5V$	65	80		dB
<b>Output Characteristics</b>						
$V_{OL}$	Output Swing Low	$I_L = -5mA$		100	200	mV
$V_{OH}$	Output Swing High	$I_L = 5mA$	4.8	4.9		V
$I_{SC}$	Short Circuit Current			$\pm 120$		mA
$I_{OUT}$	Output Current			$\pm 30$		mA
<b>Power Supply Performance</b>						
PSRR	Power Supply Rejection Ratio	$V_S$ is moved from 4.5V to 15.5V	60	80		dB
$I_S$	Supply Current (Per Amplifier)	No Load		2.5	3.75	mA
<b>Dynamic Performance</b>						
SR	Slew Rate <sup>[2]</sup>	$1V \leq V_{OUT} \leq 4V$ , 20% o 80%		33		$V/\mu s$
$t_s$	Settling to +0.1% ( $A_v = +1$ )	( $A_v = +1$ ), $V_O = 2V$ Step		140		ns
BW	-3dB Bandwidth			30		MHz
GBWP	Gain-Bandwidth Product			20		MHz
PM	Phase Margin			50		°
CS	Channel Separation	$f = 5MHz$		110		dB
$d_G$	Differential Gain <sup>[3]</sup>	$R_F = R_G = 1k\Omega$ and $V_{OUT} = 1.4V$		0.30		%
$d_P$	Differential Phase <sup>[3]</sup>	$R_F = R_G = 1k\Omega$ and $V_{OUT} = 1.4V$		0.66		°

1. Measured over operating temperature range
2. Slew rate is measured on rising and falling edges
3. NTSC signal generator used

# EL5210C/EL5410C

## 30MHz Rail-to-Rail Input-Output Op Amps

### Electrical Characteristics

$V_{S+} = 15V$ ,  $V_{S-} = 0V$ ,  $R_L = 1k\Omega$  and  $C_L = 12pF$  to 7.5V,  $T_A = 25^\circ C$  unless otherwise specified.

Parameter	Description	Condition	Min	Typ	Max	Unit
<b>Input Characteristics</b>						
$V_{OS}$	Input Offset Voltage	$V_{CM} = 7.5V$		3	15	mV
$TCV_{OS}$	Average Offset Voltage Drift <sup>[1]</sup>			7		$\mu V/^\circ C$
$I_B$	Input Bias Current	$V_{CM} = 7.5V$		2	60	nA
$R_{IN}$	Input Impedance			1		$G\Omega$
$C_{IN}$	Input Capacitance			2		pF
CMIR	Common-Mode Input Range		-0.5		+15.5	V
CMRR	Common-Mode Rejection Ratio	for $V_{IN}$ from -0.5V to 15.5V	53	72		dB
$A_{VOL}$	Open-Loop Gain	$0.5V \leq V_{OUT} \leq 14.5V$	65	80		dB
<b>Output Characteristics</b>						
$V_{OL}$	Output Swing Low	$I_L = -7.5mA$		170	350	mV
$V_{OH}$	Output Swing High	$I_L = 7.5mA$	14.65	14.83		V
$I_{SC}$	Short Circuit Current			$\pm 120$		mA
$I_{OUT}$	Output Current			$\pm 30$		mA
<b>Power Supply Performance</b>						
PSRR	Power Supply Rejection Ratio	$V_S$ is moved from 4.5V to 15.5V	60	80		dB
$I_S$	Supply Current (Per Amplifier)	No Load		2.5	3.75	mA
<b>Dynamic Performance</b>						
SR	Slew Rate <sup>[2]</sup>	$1V \leq V_{OUT} \leq 14V$ , 20% o 80%		33		V/ $\mu s$
$t_s$	Settling to +0.1% ( $A_V = +1$ )	( $A_V = +1$ ), $V_O = 2V$ Step		140		ns
BW	-3dB Bandwidth			30		MHz
GBWP	Gain-Bandwidth Product			20		MHz
PM	Phase Margin			50		$^\circ$
CS	Channel Separation	$f = 5MHz$		110		dB
$d_G$	Differential Gain <sup>[3]</sup>	$R_F = R_G = 1k\Omega$ and $V_{OUT} = 1.4V$		0.10		%
$d_P$	Differential Phase <sup>[3]</sup>	$R_F = R_G = 1k\Omega$ and $V_{OUT} = 1.4V$		0.11		$^\circ$

1. Measured over operating temperature range
2. Slew rate is measured on rising and falling edges
3. NTSC signal generator used

### Typical Performance Curves

**EL5410C Input Offset Voltage Distribution**

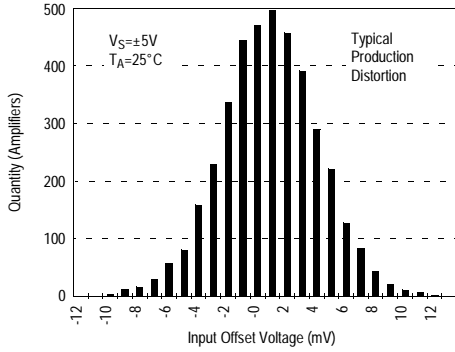

**EL5410C Input Offset Voltage Drift**

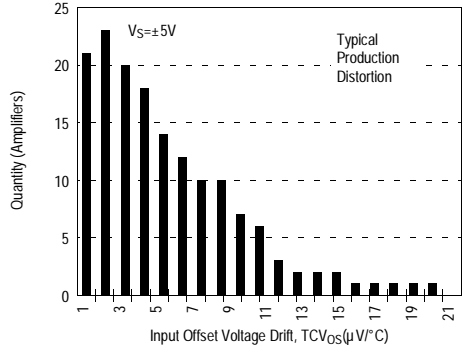

**Input Offset Voltage vs Temperature**

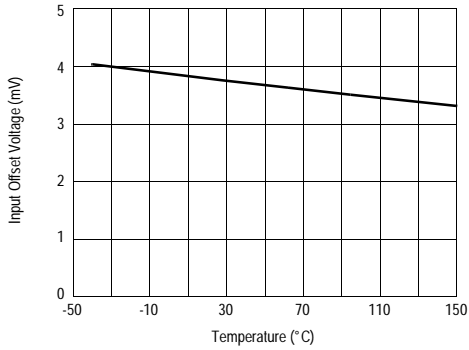

**Input Bias Current vs Temperature**

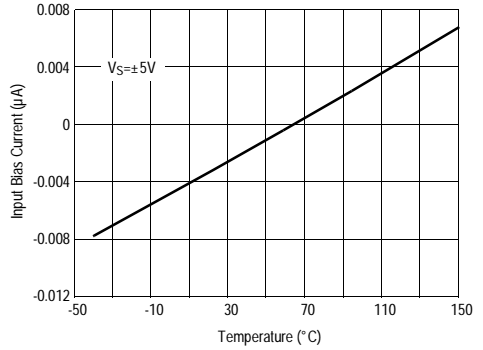

**Output High Voltage vs Temperature**

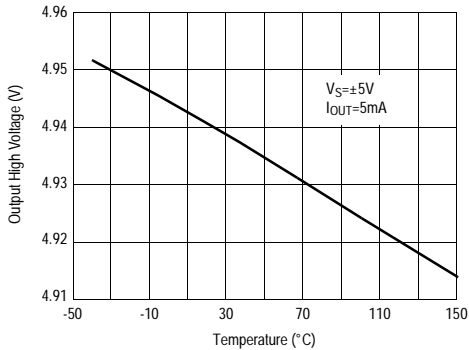

**Output Low Voltage vs Temperature**

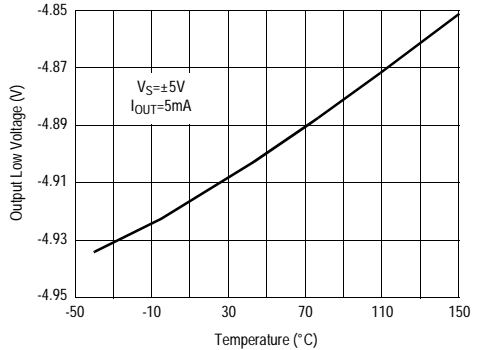

# EL5210C/EL5410C

## 30MHz Rail-to-Rail Input-Output Op Amps

### Typical Performance Curves

Open-Loop Gain vs Temperature

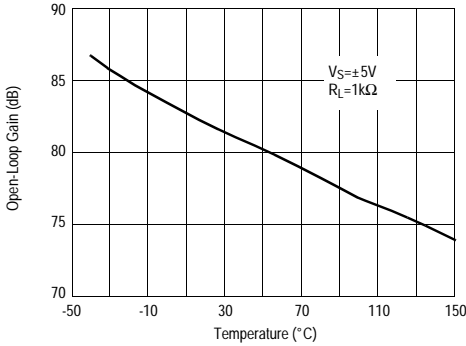

Slew Rate vs Temperature

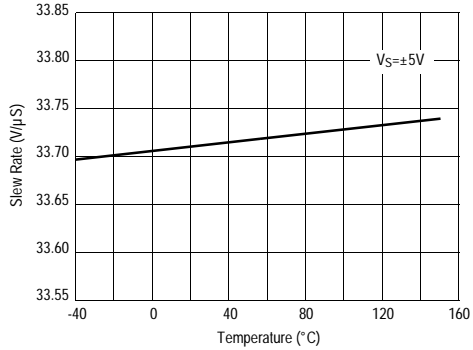

EL5410C Supply Current per Amplifier vs Supply Voltage

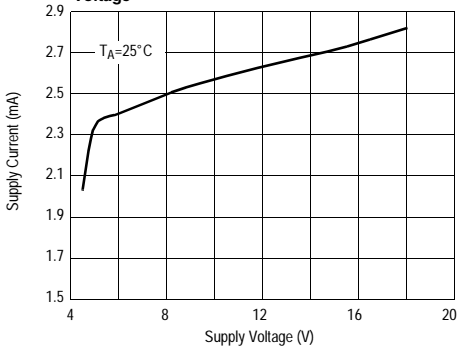

EL5410C Supply Current per Amplifier vs Temperature

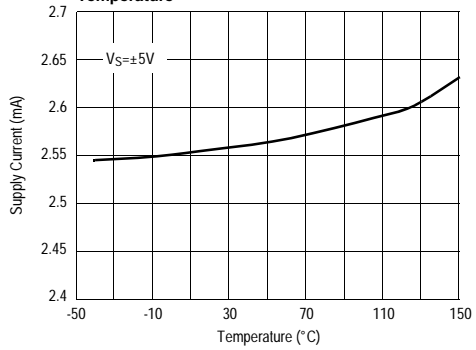

Differential Gain and Phase

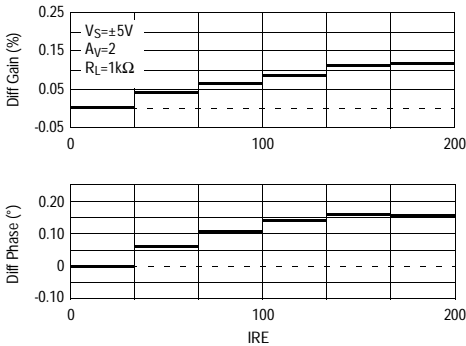

Harmonic Distortion vs VOP-P

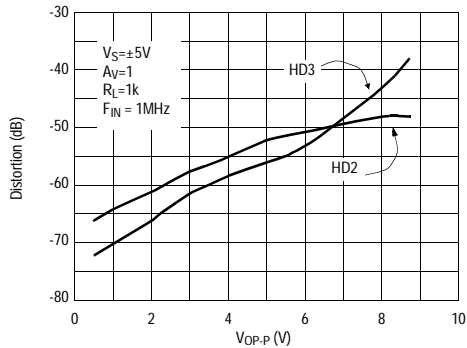

### Typical Performance Curves

**Open Loop Gain and Phase vs Frequency**

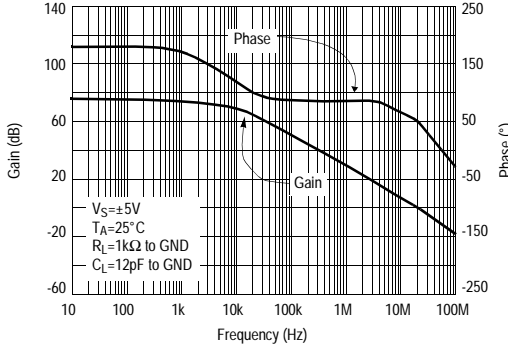

**Frequency Response for Various  $R_L$**

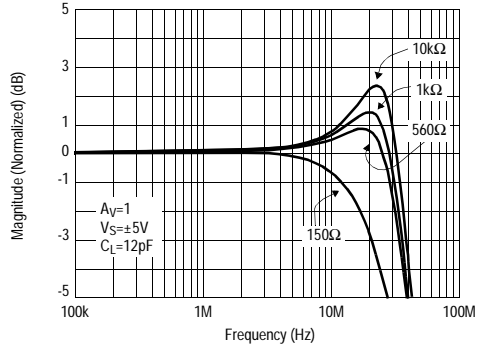

**Frequency Response for Various  $C_L$**

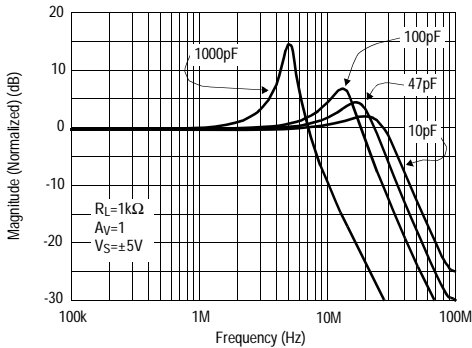

**Closed Loop Output Impedance vs Frequency**

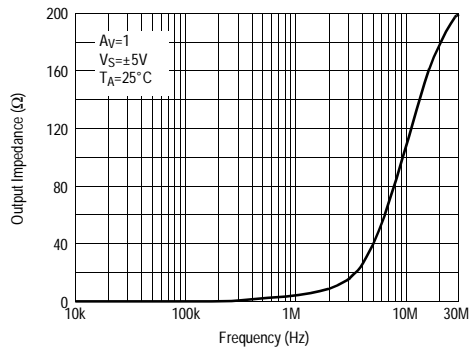

**Maximum Output Swing vs Frequency**

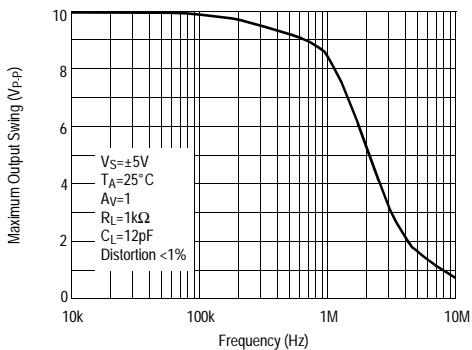

**CMRR vs Frequency**

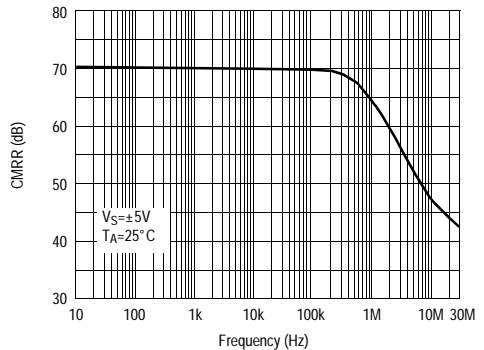

# EL5210C/EL5410C

## 30MHz Rail-to-Rail Input-Output Op Amps

### Typical Performance Curves

**PSRR vs Frequency**

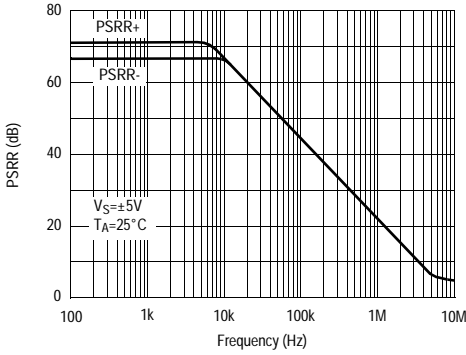

**Input Voltage Noise Spectral Density vs Frequency**

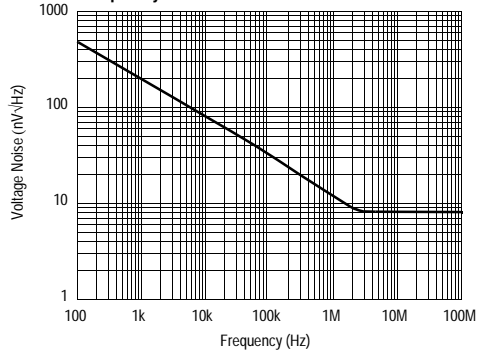

**Total Harmonic Distortion + Noise vs Frequency**

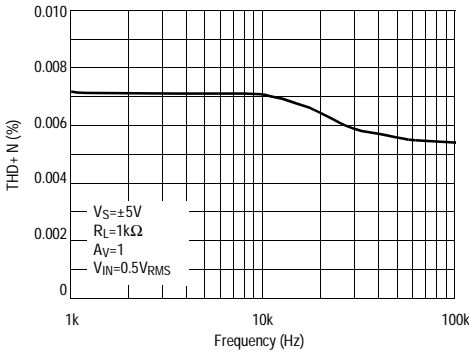

**Channel Separation vs Frequency Response**

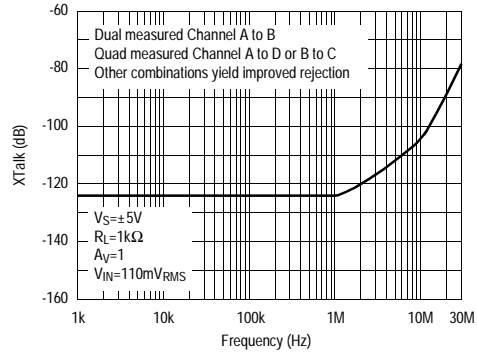

**Small-Signal Overshoot vs Load Capacitance**

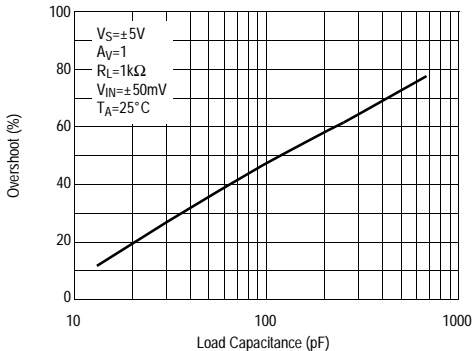

**Setting Time vs Step Size**

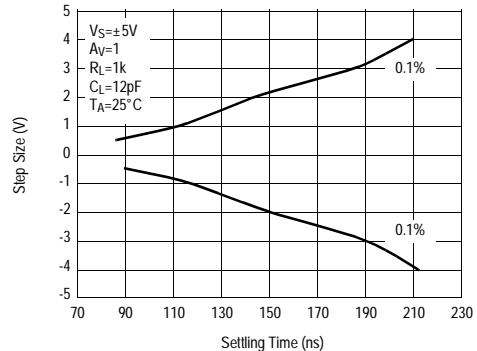



## Typical Performance Curves

Large Signal Transient Response

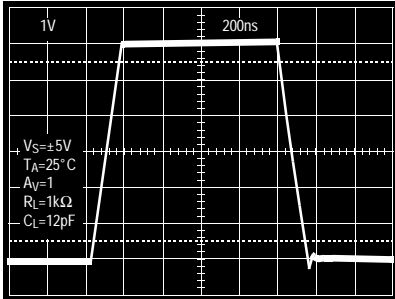

Small Signal Transient Response

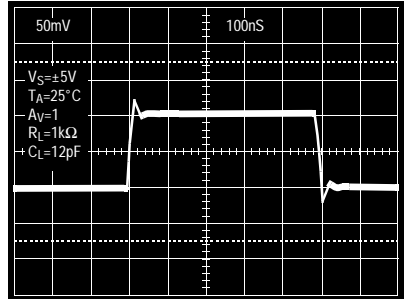

# EL5210C/EL5410C

## 30MHz Rail-to-Rail Input-Output Op Amps

### Pin Descriptions

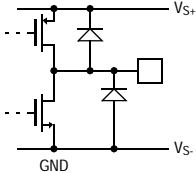
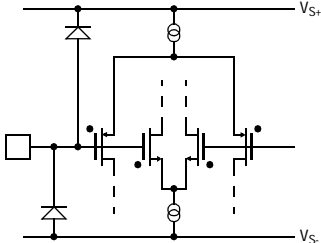
EL5210C	EL5410C	Name	Function	Equivalent Circuit
1	1	V <sub>OUTA</sub>	Amplifier A Output	 <p style="text-align: center;"><b>Circuit 1</b></p>
2	2	V <sub>INA-</sub>	Amplifier A Inverting Input	 <p style="text-align: center;"><b>Circuit 2</b></p>
3	3	V <sub>INA+</sub>	Amplifier A Non-Inverting Input	(Reference Circuit 2)
8	4	V <sub>S+</sub>	Positive Power Supply	
5	5	V <sub>INB+</sub>	Amplifier B Non-Inverting Input	(Reference Circuit 2)
6	6	V <sub>INB-</sub>	Amplifier B Inverting Input	(Reference Circuit 2)
7	7	V <sub>OUTB</sub>	Amplifier B Output	(Reference Circuit 1)
	8	V <sub>OUTC</sub>	Amplifier C Output	(Reference Circuit 1)
	9	V <sub>INC-</sub>	Amplifier C Inverting Input	(Reference Circuit 2)
	10	V <sub>INC+</sub>	Amplifier C Non-Inverting Input	(Reference Circuit 2)
4	11	V <sub>S-</sub>	Negative Power Supply	
	12	V <sub>IND+</sub>	Amplifier D Non-Inverting Input	(Reference Circuit 2)
	13	V <sub>IND-</sub>	Amplifier D Inverting Input	(Reference Circuit 2)
	14	V <sub>OUTD</sub>	Amplifier D Output	(Reference Circuit 1)

## Applications Information

### Product Description

The EL5210C and EL5410C voltage feedback amplifiers are fabricated using a high voltage CMOS process. They exhibit Rail-to-Rail input and output capability, are unity gain stable and have low power consumption (2.5mA per amplifier). These features make the EL5210C and EL5410C ideal for a wide range of general-purpose applications. Connected in voltage follower mode and driving a load of 1k $\Omega$  and 12pF, the EL5210C and EL5410C have a -3dB bandwidth of 30MHz while maintaining a 33V/ $\mu$ S slew rate. The EL5210C is a dual amplifier while the EL5410C is a quad amplifier.

### Operating Voltage, Input, and Output

The EL5210C and EL5410C are specified with a single nominal supply voltage from 5V to 15V or a split supply with its total range from 5V to 15V. Correct operation is guaranteed for a supply range of 4.5V to 16.5V. Most EL5210C and EL5410C specifications are stable over both the full supply range and operating temperatures of -40 °C to +85 °C. Parameter variations with operating voltage and/or temperature are shown in the typical performance curves.

The input common-mode voltage range of the EL5210C and EL5410C extends 500mV beyond the supply rails. The output swings of the EL5210C and EL5410C typically extend to within 100mV of positive and negative supply rails with load currents of 5mA. Decreasing load currents will extend the output voltage range even closer to the supply rails. Figure 1 shows the input and output waveforms for the device in the unity-gain configuration. Operation is from +/-5V supply with a 1k $\Omega$  load

connected to GND. The input is a 10Vp-p sinusoid. The output voltage is approximately 9.8Vp-p.

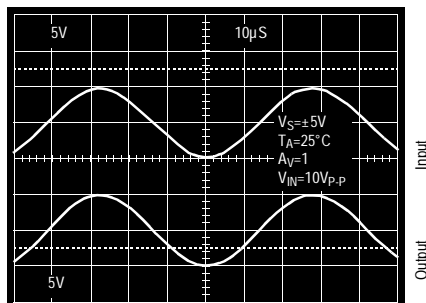

**Figure 1. Operation with Rail-to-Rail Input and Output**

### Short Circuit Current Limit

The EL5210C and EL5410C will limit the short circuit current to +/-120mA if the output is directly shorted to the positive or the negative supply. If an output is shorted indefinitely, the power dissipation could easily increase such that the device may be damaged. Maximum reliability is maintained if the output continuous current never exceeds +/-30mA. This limit is set by the design of the internal metal interconnects.

### Output Phase Reversal

The EL5210C and EL5410C are immune to phase reversal as long as the input voltage is limited from  $V_S - 0.5V$  to  $V_S + 0.5V$ . Figure 2 shows a photo of the output of the device with the input voltage driven beyond the supply rails. Although the device's output will not change phase, the input's overvoltage should be avoided. If an input voltage exceeds supply voltage by more than 0.6V, electrostatic protection diodes placed in the input

# EL5210C/EL5410C

## 30MHz Rail-to-Rail Input-Output Op Amps

stage of the device begin to conduct and overvoltage damage could occur.

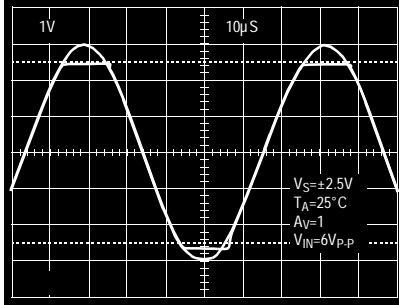

**Figure 2. Operation with Beyond-the-Rails Input**

### Power Dissipation

With the high-output drive capability of the EL5210C and EL5410C amplifiers, it is possible to exceed the 125°C 'absolute-maximum junction temperature' under certain load current conditions. Therefore, it is important to calculate the maximum junction temperature for the application to determine if load conditions need to be modified for the amplifier to remain in the safe operating area.

The maximum power dissipation allowed in a package is determined according to:

$$P_{DMAX} = \frac{T_{JMAX} - T_{AMAX}}{\Theta_{JA}}$$

Where:

$T_{JMAX}$  = Maximum Junction Temperature

$T_{AMAX}$  = Maximum Ambient Temperature

$\Theta_{JA}$  = Thermal Resistance of the Package

$P_{DMAX}$  = Maximum Power Dissipation in the Package.

The maximum power dissipation actually produced by an IC is the total quiescent supply current times the total

power supply voltage, plus the power in the IC due to the loads, or:

$$P_{DMAX} = \Sigma i [V_S \times I_{SMAX} + (V_S + V_{OUTi}) \times I_{LOADi}]$$

when sourcing, and

$$P_{DMAX} = \Sigma i [V_S \times I_{SMAX} + (V_{OUTi} - V_S) \times I_{LOADi}]$$

when sinking.

Where:

$i$  = 1 to 2 for Dual and 1 to 4 for Quad

$V_S$  = Total Supply Voltage

$I_{SMAX}$  = Maximum Supply Current Per Amplifier

$V_{OUTi}$  = Maximum Output Voltage of the Application

$I_{LOADi}$  = Load current

If we set the two  $P_{DMAX}$  equations equal to each other, we can solve for  $R_{LOADi}$  to avoid device overheat. Figure 3 and Figure 4 provide a convenient way to see if the device will overheat. The maximum safe power dissipation can be found graphically, based on the package type and the ambient temperature. By using the previous equation, it is a simple matter to see if  $P_{DMAX}$  exceeds the device's power derating curves. To ensure proper operation, it is important to observe the recommended derating curves shown in Figure 3 and Figure 4.

# EL5210C/EL5410C

## 30MHz Rail-to-Rail Input-Output Op Amps

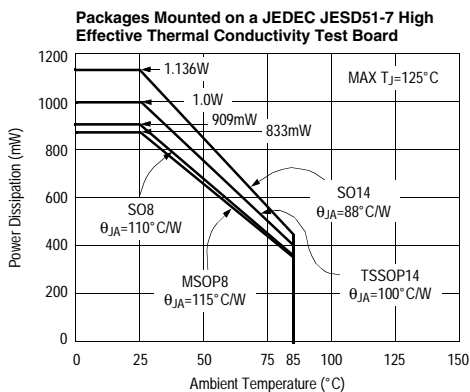

**Figure 3. Package Power Dissipation vs Ambient Temperature**

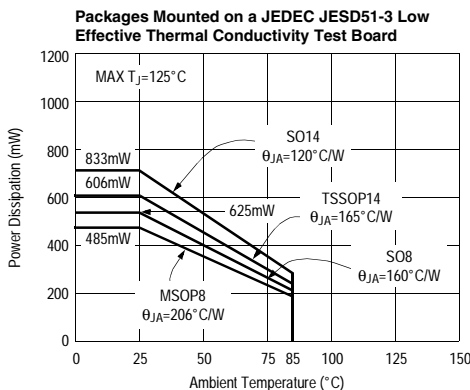

**Figure 4. Package Power Dissipation vs Ambient Temperature**

### Unused Amplifiers

It is recommended that any unused amplifiers in a dual and a quad package be configured as a unity gain fol-

lower. The inverting input should be directly connected to the output and the non-inverting input tied to the ground plane.

### Driving Capacitive Loads

The EL5210C and EL5410C can drive a wide range of capacitive loads. As load capacitance increases, however, the -3dB bandwidth of the device will decrease and the peaking increase. The amplifiers drive 10pF loads in parallel with 1k $\Omega$  with just 1.2dB of peaking, and 100pF with 6.5dB of peaking. If less peaking is desired in these applications, a small series resistor (usually between 5 $\Omega$  and 50 $\Omega$ ) can be placed in series with the output. However, this will obviously reduce the gain slightly. Another method of reducing peaking is to add a "snubber" circuit at the output. A snubber is a shunt load consisting of a resistor in series with a capacitor. Values of 150 $\Omega$  and 10nF are typical. The advantage of a snubber is that it does not draw any DC load current or reduce the gain

### Power Supply Bypassing and Printed Circuit Board Layout

The EL5210C and EL5410C can provide gain at high frequency. As with any high-frequency device, good printed circuit board layout is necessary for optimum performance. Ground plane construction is highly recommended, lead lengths should be as short as possible and the power supply pins must be well bypassed to reduce the risk of oscillation. For normal single supply operation, where the V<sub>S-</sub> pin is connected to ground, a 0.1 $\mu$ F ceramic capacitor should be placed from V<sub>S+</sub> to pin to V<sub>S-</sub> pin. A 4.7 $\mu$ F tantalum capacitor should then be connected in parallel, placed in the region of the amplifier. One 4.7 $\mu$ F capacitor may be used for multiple devices. This same capacitor combination should be placed at each supply pin to ground if split supplies are to be used.

# **EL5210C/EL5410C**

**30MHz Rail-to-Rail Input-Output Op Amps**

## **General Disclaimer**

Specifications contained in this data sheet are in effect as of the publication date shown. Elantec, Inc. reserves the right to make changes in the circuitry or specifications contained herein at any time without notice. Elantec, Inc. assumes no responsibility for the use of any circuits described herein and makes no representations that they are free from patent infringement.

***élantec***  
HIGH PERFORMANCE ANALOG INTEGRATED CIRCUITS

## **Elantec Semiconductor, Inc.**

675 Trade Zone Blvd.  
Milpitas, CA 95035  
Telephone: (408) 945-1323  
(888) ELANTEC  
Fax: (408) 945-9305  
European Office: +44-118-977-6080  
Japan Technical Center: +81-45-682-5820

## **WARNING - Life Support Policy**

Elantec, Inc. products are not authorized for and should not be used within Life Support Systems without the specific written consent of Elantec, Inc. Life Support systems are equipment intended to support or sustain life and whose failure to perform when properly used in accordance with instructions provided can be reasonably expected to result in significant personal injury or death. Users contemplating application of Elantec, Inc. Products in Life Support Systems are requested to contact Elantec, Inc. factory headquarters to establish suitable terms & conditions for these applications. Elantec, Inc.'s warranty is limited to replacement of defective components and does not cover injury to persons or property or other consequential damages.