

1GHz Triple Current Feedback Amplifier

The EL5367 triple amplifier is of the current feedback variety and exhibits a very high bandwidth of 1GHz at $A_V = +1$ and 800MHz at $A_V = +2$. This makes this amplifier ideal for today's high speed video and monitor applications, as well as a number of RF and IF frequency designs.

With a total supply current of just 25mA and the ability to run from a single supply voltage from 5V to 12V, this amplifier offers very high performance for little power consumption.

The EL5367 is available in a 16-pin QSOP package and is specified for operation over the full -40°C to $+85^{\circ}\text{C}$ temperature range.

Pinout

EL5367
(16-PIN QSOP)
TOP VIEW

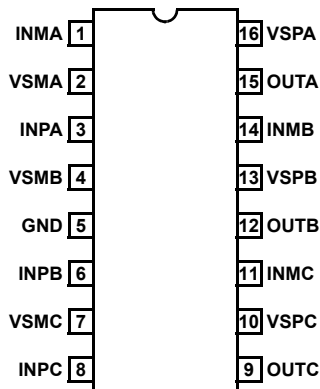

Features

- Gain-of-1 bandwidth = 1GHz
- Gain-of-2 bandwidth = 800MHz
- 6000V/ μs slew rate
- Single and dual supply operation from 5V to 12V
- Low noise = 1.7nV/ $\sqrt{\text{Hz}}$
- 8.5mA supply current

Applications

- Video amplifiers
- Cable drivers
- RGB amplifiers
- Test equipment
- Instrumentation
- Current-to-voltage converters

Ordering Information

PART NUMBER	PACKAGE	TAPE & REEL	PKG. DWG. #
EL5367IU	16-Pin QSOP	-	MDP0040
EL5367IU-T7	16-Pin QSOP	7"	MDP0040
EL5367IU-T13	16-Pin QSOP	13"	MDP0040

Absolute Maximum Ratings ($T_A = 25^\circ\text{C}$)

Supply Voltage between V_{S+} and V_{S-} 13.2V
 Maximum Continuous Output Current 50mA
 I_{OUT} $\pm 200\text{mA}$
 I into V_{IN+} , V_{IN-} $\pm 4\text{mA}$
 Power Dissipation See Curves

Pin Voltages $V_{S-} - 0.5\text{V}$ to $V_{S+} + 0.5\text{V}$
 Storage Temperature -65°C to $+150^\circ\text{C}$
 Ambient Operating Temperature -40°C to $+85^\circ\text{C}$
 Die Junction Temperature $+125^\circ\text{C}$

CAUTION: Stresses above those listed in "Absolute Maximum Ratings" may cause permanent damage to the device. This is a stress only rating and operation of the device at these or any other conditions above those indicated in the operational sections of this specification is not implied.

IMPORTANT NOTE: All parameters having Min/Max specifications are guaranteed. Typical values are for information purposes only. Unless otherwise noted, all tests are at the specified temperature and are pulsed tests, therefore: $T_J = T_C = T_A$

Electrical Specifications $V_{S+} = +5\text{V}$, $V_{S-} = -5\text{V}$, $R_F = 392\Omega$ for $A_V = 1$, $R_F = 250\Omega$ for $A_V = 2$, $R_L = 150\Omega$, $T_A = 25^\circ\text{C}$, unless otherwise specified.

PARAMETER	DESCRIPTION	CONDITIONS	MIN	TYP	MAX	UNIT
AC PERFORMANCE						
BW	-3dB Bandwidth (per channel)	$A_V = +1$		1000		MHz
		$A_V = +2$		800		MHz
BW1	0.1dB Bandwidth (per channel)	$A_V = +2$		100		MHz
SR	Slew Rate	$V_O = -2.5\text{V}$ to $+2.5\text{V}$, $A_V = +2$	3000	6000		V/ μs
t_S	0.1% Settling Time	$V_{OUT} = -2.5\text{V}$ to $+2.5\text{V}$, $A_V = -1$		8		ns
e_N	Input Voltage Noise			1.7		nV/ $\sqrt{\text{Hz}}$
i_{N-}	IN- Input Current Noise			19		pA/ $\sqrt{\text{Hz}}$
i_{N+}	IN+ Input Current Noise			50		pA/ $\sqrt{\text{Hz}}$
dG	Differential Gain Error (Note 1)			0.01		%
dP	Differential Phase Error (Note 1)			0.03		°
DC PERFORMANCE						
V_{OS}	Offset Voltage		-5	-0.5	5	mV
$T_C V_{OS}$	Input Offset Voltage Temperature Coefficient	Measured from T_{MIN} to T_{MAX}		3.52		$\mu\text{V}/^\circ\text{C}$
R_{OL}	Transimpedance		0.5	1.1	2.5	$\text{M}\Omega$
INPUT CHARACTERISTICS						
CMIR	Common Mode Input Range (guaranteed by CMRR test)		± 3	± 3.3		V
CMRR	Common Mode Rejection Ratio		52	57	66	dB
-ICMR	- Input Current Common Mode Rejection		0	0.7	1	$\mu\text{A}/\text{V}$
$+I_{IN}$	+ Input Current		-25	0.7	25	μA
$-I_{IN}$	- Input Current		-25	8.5	25	μA
R_{IN}	Input Resistance		50	130	250	$\text{k}\Omega$
C_{IN}	Input Capacitance			1.5		pF
OUTPUT CHARACTERISTICS						
V_O	Output Voltage Swing	$R_L = 150\Omega$ to GND	± 3.6	± 3.8	± 4.1	V
		$R_L = 1\text{k}\Omega$ to GND	± 3.8	± 4.0	± 4.2	V
I_{OUT}	Output Current	$R_L = 10\Omega$ to GND	± 110	± 160	± 200	mA

EL5367

Electrical Specifications $V_{S+} = +5V$, $V_{S-} = -5V$, $R_F = 392\Omega$ for $A_V = 1$, $R_F = 250\Omega$ for $A_V = 2$, $R_L = 150\Omega$, $T_A = 25^\circ C$, unless otherwise specified. (Continued)

PARAMETER	DESCRIPTION	CONDITIONS	MIN	TYP	MAX	UNIT
SUPPLY						
I_S	Supply Current - Enabled	No load, $V_{IN} = 0V$	7.5	8.5	9.3	mA
PSRR	Power Supply Rejection Ratio	DC, $V_S = \pm 4.75V$ to $\pm 5.25V$	70	50		dB
-IPSR	- Input Current Power Supply Rejection	DC, $V_S = \pm 4.75V$ to $\pm 5.25V$	-0.5	0.2	1	$\mu A/V$

NOTE:

1. Standard NTSC test, AC signal amplitude = 286mV, f = 3.58MHz.

Typical Performance Curves

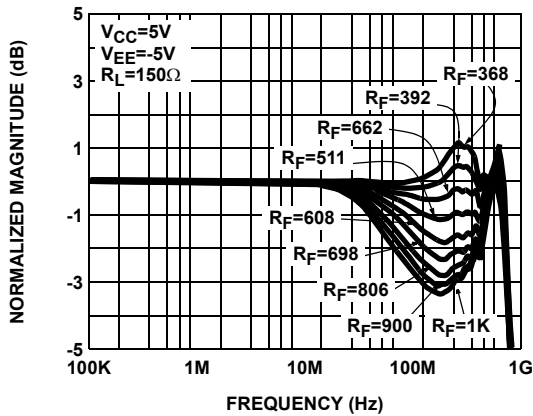

FIGURE 1. FREQUENCY RESPONSE AS THE FUNCTION OF R_F

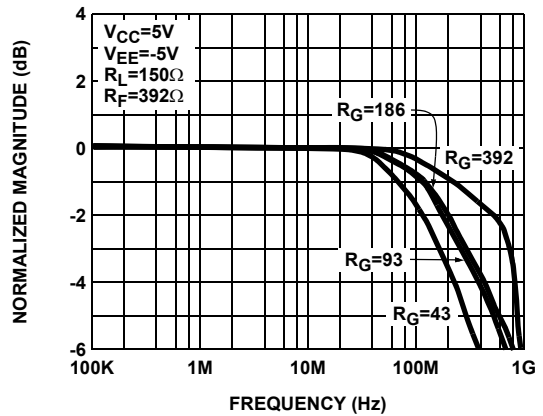

FIGURE 2. FREQUENCY RESPONSE AS THE FUNCTION OF THE GAIN

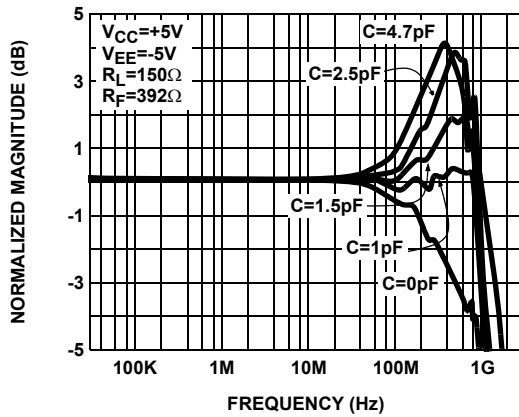

FIGURE 3. FREQUENCY RESPONSE vs C_{IN}

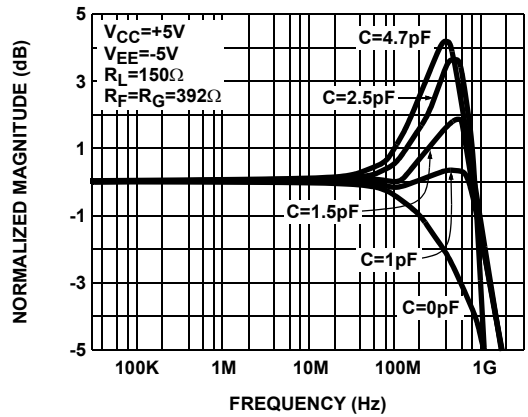

FIGURE 4. NON-INVERTING FREQUENCY RESPONSE FOR VARIOUS C_{IN-}

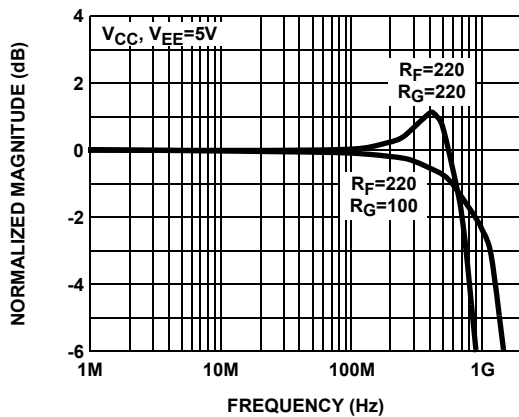

FIGURE 5. INVERTING FREQUENCY RESPONSE FOR GAIN OF 1 AND 2

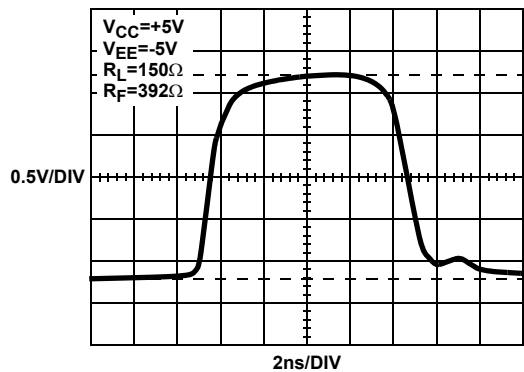

FIGURE 6. RISE AND FALL TIME

Typical Performance Curves (Continued)

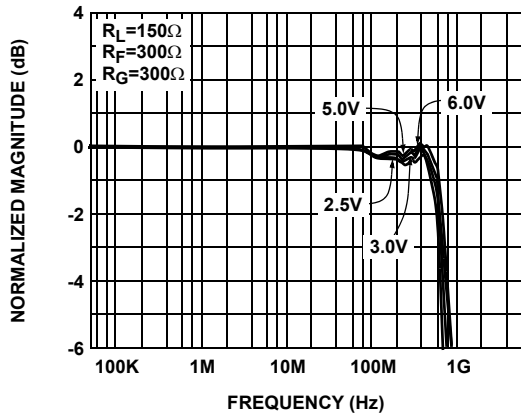

FIGURE 7. FREQUENCY RESPONSE AS THE FUNCTION OF THE POWER SUPPLY VOLTAGE

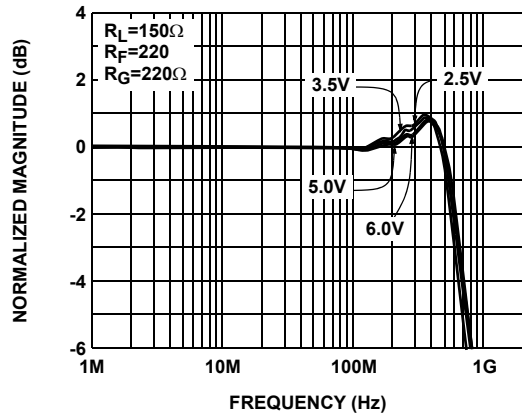

FIGURE 8. INVERTING AMPLIFIER, FREQUENCY RESPONSE AS THE FUNCTION OF V_{CC} , V_{EE} GAIN - 1

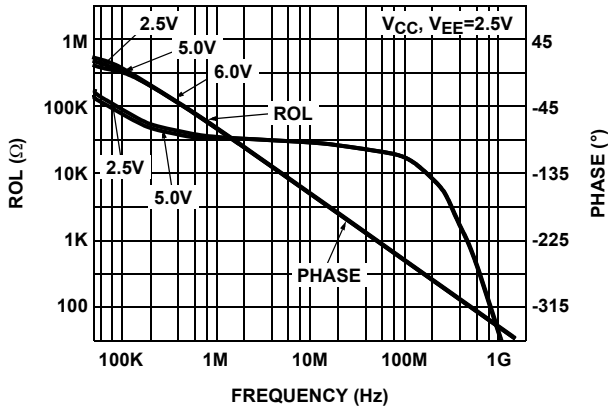

FIGURE 9. TRANSIMPEDANCE MAGNITUDE AND PHASE AS THE FUNCTION OF THE FREQUENCY

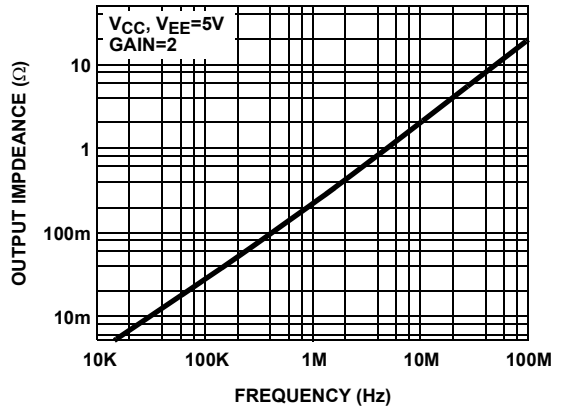

FIGURE 10. CLOSED LOOP OUTPUT IMPEDANCE vs FREQUENCY

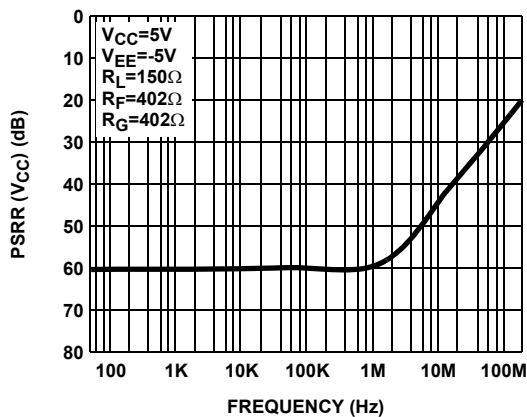

FIGURE 11. PSRR +5V

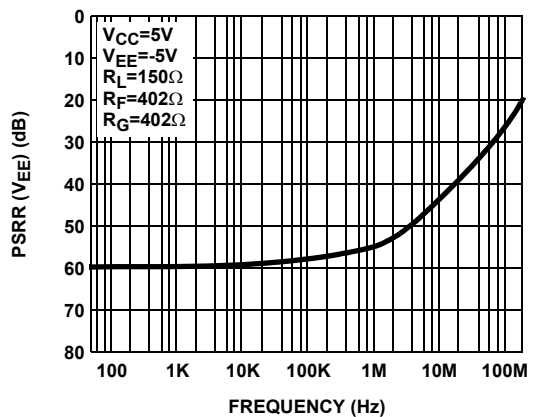

FIGURE 12. PSRR -5V

Typical Performance Curves (Continued)

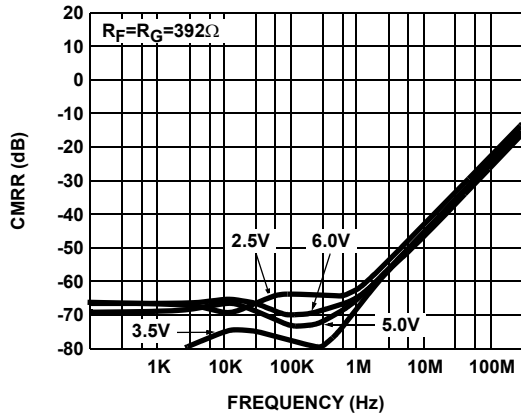

FIGURE 13. COMMON MODE REJECTION AS THE FUNCTION OF THE FREQUENCY AND POWER SUPPLY VOLTAGE

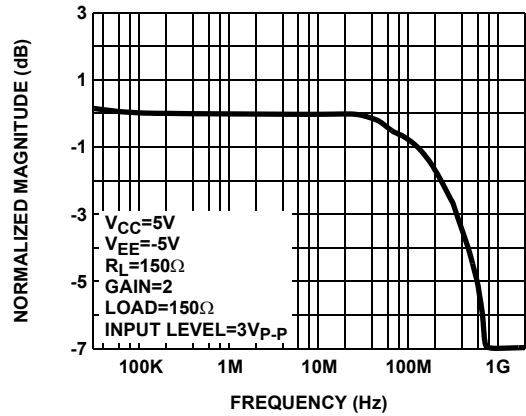

FIGURE 14. LARGE SIGNAL RESPONSE

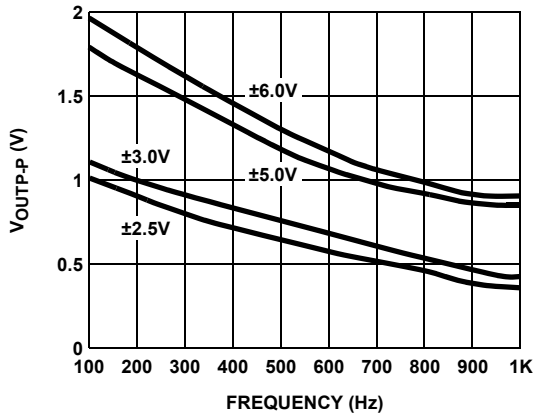

FIGURE 15. T_{OUT} vs FREQUENCY AND V_{CC} , V_{EE}

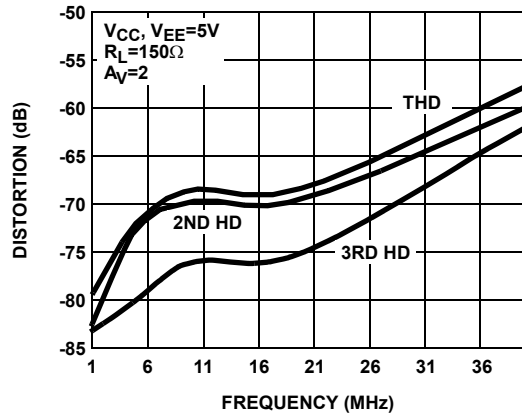

FIGURE 16. DISTORTION vs FREQUENCY

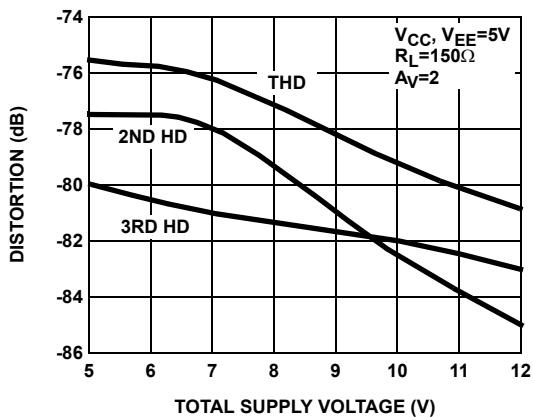

FIGURE 17. HARMONIC DISTORTION vs SUPPLY VOLTAGE

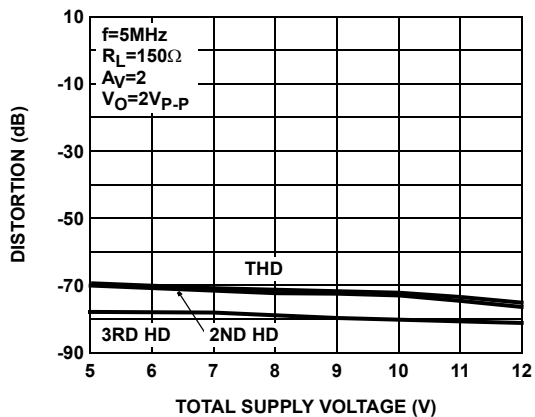

FIGURE 18. HARMONIC DISTORTION vs SUPPLY VOLTAGE

Typical Performance Curves (Continued)

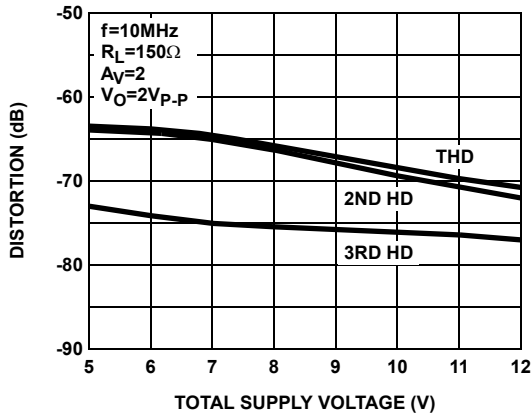

FIGURE 19. DISTORTION vs POWER SUPPLY VOLTAGE

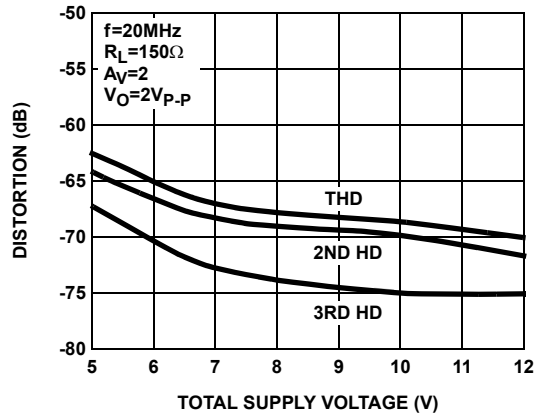

FIGURE 20. DISTORTION vs POWER SUPPLY VOLTAGE

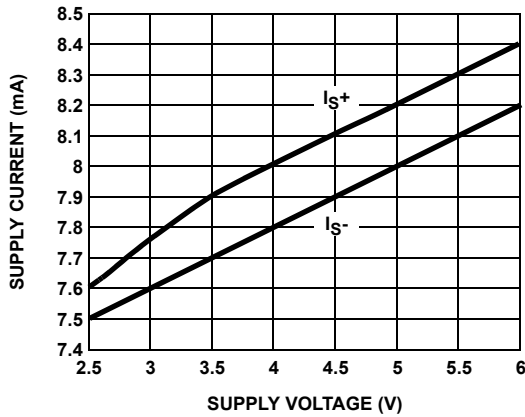

FIGURE 21. SUPPLY CURRENT vs SUPPLY VOLTAGE

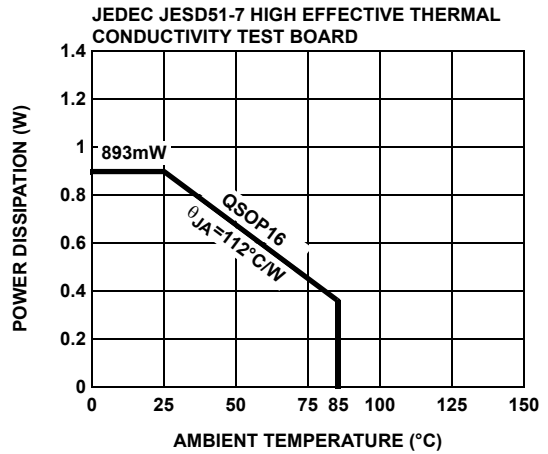

FIGURE 22. PACKAGE POWER DISSIPATION vs AMBIENT TEMPERATURE

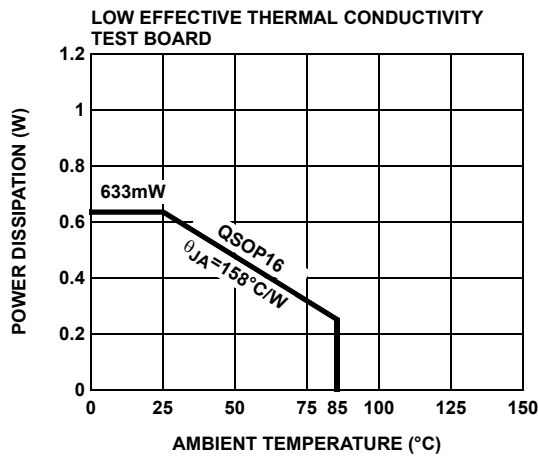

FIGURE 23. PACKAGE POWER DISSIPATION vs AMBIENT TEMPERATURE

Pin Descriptions

16-PIN QSOP	PIN NAME	FUNCTION
3	INPA	Non-inverting input
6	INPB	Non-inverting input
8	INPC	Non-inverting input
1	INMA	Inverting
14	INMB	Inverting
11	INMC	Inverting
2	VSMA	Negative supply
4	VSMB	Negative supply
7	VSMC	Negative supply
16	VSPA	Positive supply
13	VSPB	Positive supply
10	VSPC	Positive supply
15	OUTA	Output
12	OUTB	Output
9	OUTC	Output

Applications Information

Product Description

The EL5367 is a current-feedback operational amplifier that offers a wide -3dB bandwidth of 1GHz and a low supply current of 8.5mA per amplifier. The EL5367 works with supply voltages ranging from a single 5V to 10V and it is also capable of swinging to within 1V of either supply on the output. Because of their current-feedback topology, the EL5367 does not have the normal gain-bandwidth product associated with voltage-feedback operational amplifiers. Instead, its -3dB bandwidth remains relatively constant as closed-loop gain is increased. This combination of high bandwidth and low power, together with aggressive pricing make the EL5367 an ideal choice for many low-power/high-bandwidth applications such as portable, handheld, or battery-powered equipment.

Power Supply Bypassing and Printed Circuit Board Layout

As with any high frequency device, good printed circuit board layout is necessary for optimum performance. Low impedance ground plane construction is essential. Surface mount components are recommended, but if leaded components are used, lead lengths should be as short as possible. The power supply pins must be well bypassed to reduce the risk of oscillation. The combination of a 4.7 μ F tantalum capacitor in parallel with a 0.01 μ F capacitor has been shown to work well when placed at each supply pin.

For good AC performance, parasitic capacitance should be kept to a minimum, especially at the inverting input. (See the Capacitance at the Inverting Input section) Even when ground plane construction is used, it should be removed from the area near the inverting input to minimize any stray capacitance at that node. Carbon or Metal-Film resistors are acceptable with the Metal-Film resistors giving slightly less peaking and bandwidth because of additional series inductance. Use of sockets, particularly for the SO package, should be avoided if possible. Sockets add parasitic inductance and capacitance which will result in additional peaking and overshoot.

Capacitance at the Inverting Input

Any manufacturer's high-speed voltage- or current-feedback amplifier can be affected by stray capacitance at the inverting input. For inverting gains, this parasitic capacitance has little effect because the inverting input is a virtual ground. But for non-inverting gains, this capacitance (in conjunction with the feedback and gain resistors) creates a pole in the feedback path of the amplifier. This pole, if low enough in frequency, has the same destabilizing effect as a zero in the forward open-loop response. The use of large value feedback and gain resistors exacerbates the problem by further lowering the pole frequency (increasing the possibility of oscillation).

The EL5367 frequency response is optimized with the resistor values in Figure 3. With the high bandwidth of this amplifier, these resistor values might cause stability problems when combined with parasitic capacitance, thus ground plane is not recommended around the inverting input pin of the amplifier.

Feedback Resistor Values

The EL5367 has been designed and specified at a gain of +2 with R_F approximately 392 Ω . This value of feedback resistor gives 800MHz of -3dB bandwidth at $A_V = 2$ with about 0.5dB of peaking. Since the EL5367 is current-feedback amplifier, it is also possible to change the value of R_F to get more bandwidth. As seen in the curve of Frequency Response for Various R_F and R_G , bandwidth and peaking can be easily modified by varying the value of the feedback resistor.

Because the EL5367 is a current-feedback amplifier, its gain-bandwidth product is not a constant for different closed-loop gains. This feature actually allows the EL5367 to maintain reasonable constant -3dB bandwidth for different gains. As gain is increased, bandwidth decreases slightly while stability increases. Since the loop stability is improving with higher closed-loop gains, it becomes possible to reduce the value of R_F below the specified 250 Ω and still retain stability, resulting in only a slight loss of bandwidth with increased closed-loop gain.

Supply Voltage Range and Single-Supply Operation

The EL5367 has been designed to operate with supply voltages having a span of greater than 5V and less than 10V. In practical terms, this means that the EL5367 will operate on dual supplies ranging from $\pm 2.5V$ to $\pm 5V$. With single-supply, they will operate from 5V to 10V.

As supply voltages continue to decrease, it becomes necessary to provide input and output voltage ranges that can get as close as possible to the supply voltages. The EL5367 has an input range which extends to within 1.8V of either supply. So, for example, on $\pm 5V$ supplies, the EL5367 has an input range which spans $\pm 3.2V$. The output range of the EL5367 is also quite large, extending to within 1V of the supply rail. On a $\pm 5V$ supply, the output is therefore capable of swinging from -4V to +4V.

Video Performance

For good video performance, an amplifier is required to maintain the same output impedance and the same frequency response as DC levels are changed at the output. This is especially difficult when driving a standard video load of 150Ω , because of the change in output current with DC level. Previously, good differential gain could only be achieved by running high idle currents through the output transistors (to reduce variations in output impedance.) These currents were typically comparable to the entire 8.5mA supply current of each EL5367 amplifier. Special circuitry has been incorporated in the EL5367 to reduce the variation of output impedance with current output. This results in dG and dP specifications of 0.01% and 0.03° , while driving 150Ω at a gain of 2.

Output Drive Capability

In spite of the low 8.5mA of supply current, the EL5367 is capable of providing a minimum of $\pm 110mA$ of output current. With so much output drive, the EL5367 is capable of driving 50Ω loads to both rails, making it an excellent choice for driving isolation transformers in telecommunications applications.

Driving Cables and Capacitive Loads

When used as a cable driver, double termination is always recommended for reflection-free performance. For those applications, the back-termination series resistor will decouple the EL5367 from the cable and allow extensive capacitive drive. However, other applications may have high capacitive loads without a back-termination resistor. In these applications, a small series resistor (usually between 5Ω and 50Ω) can be placed in series with the output to eliminate most peaking. The gain resistor (R_G) can then be chosen to make up for any gain loss which may be created by this additional resistor at the output. In many cases it is also possible to simply increase the value of the feedback resistor (R_F) to reduce the peaking.

Current Limiting

The EL5367 has no internal current-limiting circuitry. If the output is shorted, it is possible to exceed the Absolute Maximum Rating for output current or power dissipation, potentially resulting in the destruction of the device.

Power Dissipation

With the high output drive capability of the EL5367, it is possible to exceed the $125^\circ C$ Absolute Maximum junction temperature under certain very high load current conditions. Generally speaking when R_L falls below about 25Ω , it is important to calculate the maximum junction temperature (T_{JMAX}) for the application to determine if power supply voltages, load conditions, or package type need to be modified for the EL5367 to remain in the safe operating area. These parameters are calculated as follows:

$$T_{JMAX} = T_{MAX} + (\theta_{JA} \times n \times PD_{MAX})$$

where:

T_{MAX} = Maximum ambient temperature

θ_{JA} = Thermal resistance of the package

n = Number of amplifiers in the package

PD_{MAX} = Maximum power dissipation of each amplifier in the package

PD_{MAX} for each amplifier can be calculated as follows:

$$PD_{MAX} = (2 \times V_S \times I_{SMAX}) + \left[(V_S - V_{OUTMAX}) \times \frac{V_{OUTMAX}}{R_L} \right]$$

where:

V_S = Supply voltage

I_{SMAX} = Maximum supply current of 1A

V_{OUTMAX} = Maximum output voltage (required)

R_L = Load resistance

Typical Application Circuits

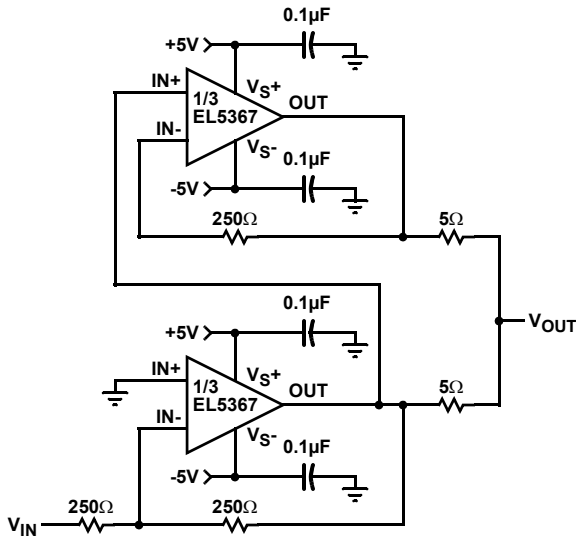

FIGURE 24. INVERTING 200mA OUTPUT CURRENT DISTRIBUTION AMPLIFIER

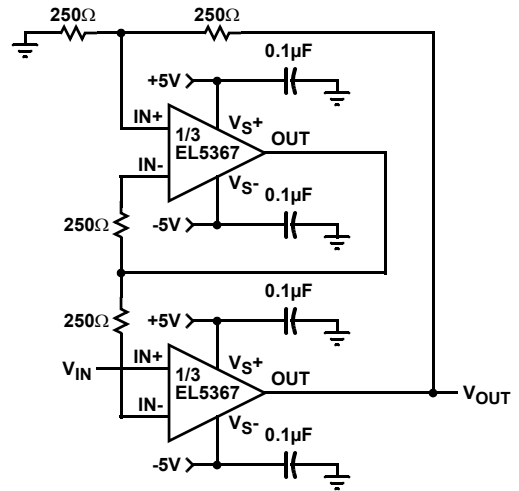

FIGURE 25. FAST-SETTLING PRECISION AMPLIFIER

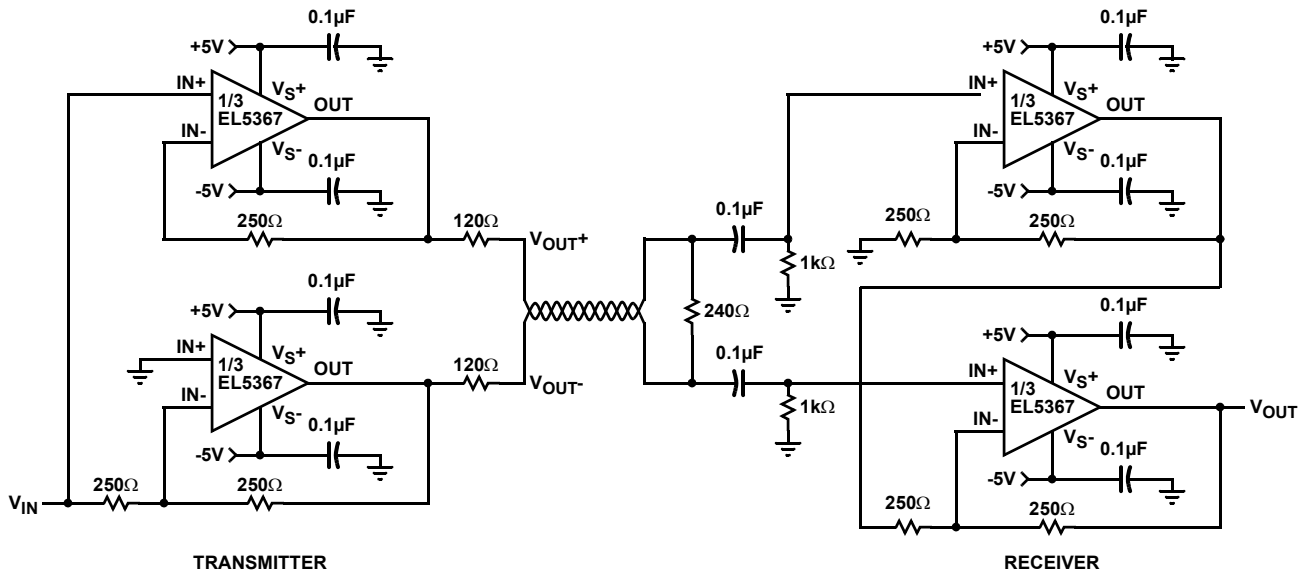
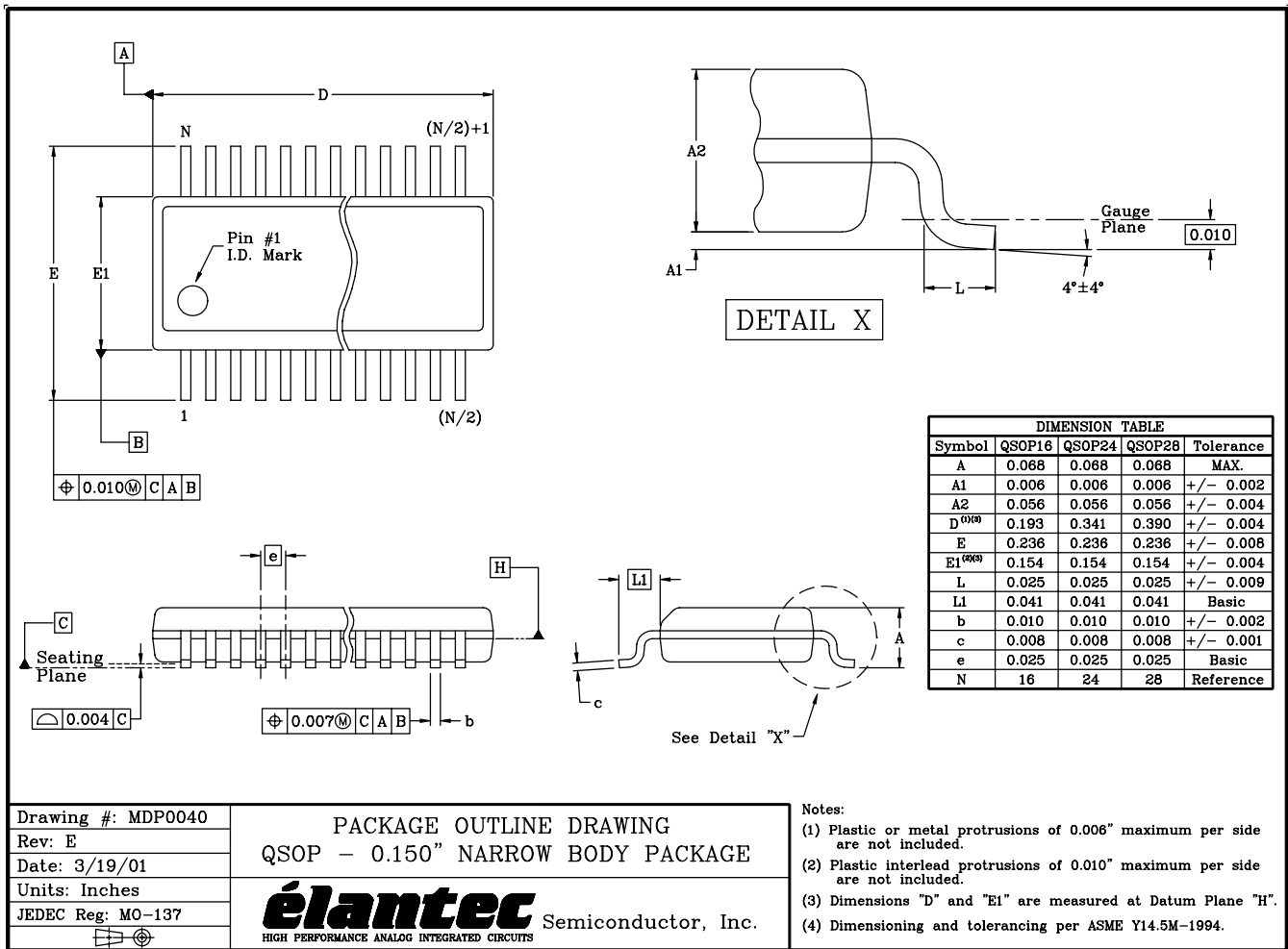

FIGURE 26. DIFFERENTIAL LINE DRIVER/RECEIVER

Package Outline Drawing



NOTE: The package drawing shown here may not be the latest version. To check the latest revision, please refer to the Intersil website at <<http://www.intersil.com/design/packages/index.asp>>

All Intersil U.S. products are manufactured, assembled and tested utilizing ISO9000 quality systems. Intersil Corporation's quality certifications can be viewed at www.intersil.com/design/quality

Intersil products are sold by description only. Intersil Corporation reserves the right to make changes in circuit design, software and/or specifications at any time without notice. Accordingly, the reader is cautioned to verify that data sheets are current before placing orders. Information furnished by Intersil is believed to be accurate and reliable. However, no responsibility is assumed by Intersil or its subsidiaries for its use; nor for any infringements of patents or other rights of third parties which may result from its use. No license is granted by implication or otherwise under any patent or patent rights of Intersil or its subsidiaries.

For information regarding Intersil Corporation and its products, see www.intersil.com