



EVERLIGHT ELECTRONICS CO.,LTD.

Technical Data Sheet 0.56" Quadruple Digit Displays

ELF-511GWA

■ Features :

- Industrial standard size.
- Low power consumption.
- Categorized for luminous intensity.
- Pb free

■ Descriptions :

- The ELF-511 series is a large 14.22mm (0.56")high seven segment display designed for viewing distances up to 7 meters.
- These displays provide excellent reliability in bright ambient light.
- These devices are made with white segments and gray surface.

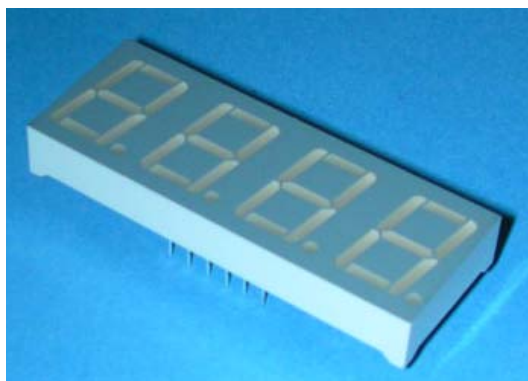

■ Applications :

- Audio equipment
- Instrument panels
- Digital read out display

PART NO.	Chip	
	Material	Emitted Color
ELF-511GWA	GaP	Green



EVERLIGHT ELECTRONICS CO.,LTD.

Technical Data Sheet 0.56" Quadruple Digit Displays

ELF-511GWA

Package Dimensions

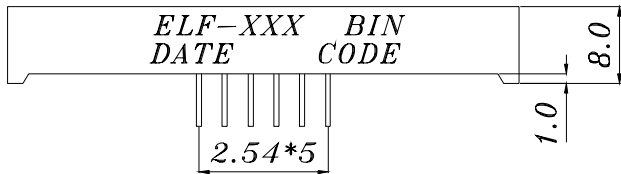
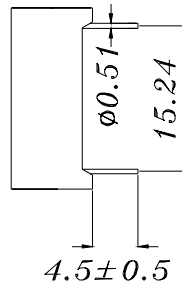
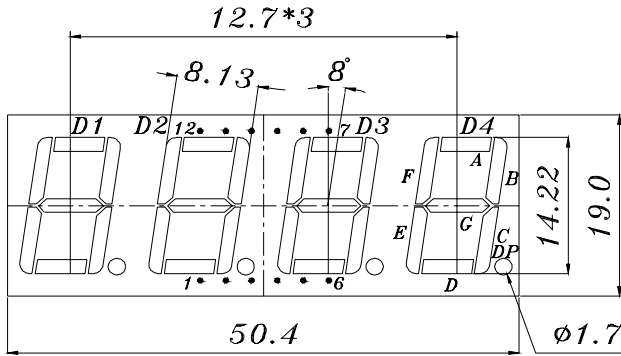

- COMMON CATHODE*
- 1 ANODE E
 - 2 ANODE D
 - 3 ANODE DP
 - 4 ANODE C
 - 5 ANODE G
 - 6 COMMON CATHODE D4
 - 7 ANODE B
 - 8 COMMON CATHODE D3
 - 9 COMMON CATHODE D2
 - 10 ANODE F
 - 11 ANODE A
 - 12 COMMON CATHODE D1

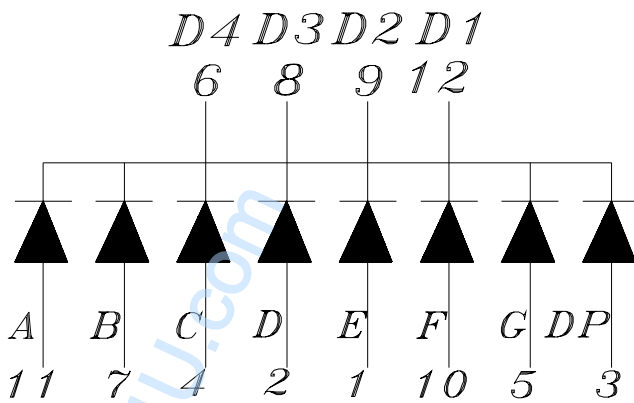

Notes: 1. All dimensions are in millimeters , tolerance is 0.25mm unless otherwise noted.
 2. Above specification may be changed without notice.
 Supplier will reserve authority on material change for above specification.



Technical Data Sheet

0.56" Quadruple Digit Displays

ELF-511GWA

■ Absolute maximum ratings at Ta = 25°C :

Parameter	Symbol	Rating	Unit
Reverse Voltage	V _R	5	V
Forward Current	I _F	30	mA
Operating Temperature	T _{opr}	-40 to +85	°C
Storage Temperature	T _{stg}	-40 to +100	°C
Soldering Temperature	T _{sol}	260 ± 5	°C
Power Dissipation	P _d	100	mW
Peak Forward Current(Duty 1/10 @ 1KHz)	I _{F(Peak)}	160	mA

■ Electronic optical characteristics :

Parameter		Symbol	Min.	Typ.	Max.	Unit	Condition
Luminous Intensity	Per segment	I _v	1.4	3.0	----	mcd	I _F =10mA
	Per decimal point		0.6	1.0	----	mcd	I _F =10mA
Peak Wavelength		λ _p	----	565	----	nm	I _F =20mA
Dominant Wavelength		λ _d	----	570	----	nm	I _F =20mA
Spectrum Radiation Bandwidth		Δλ	----	30	----	nm	I _F =20mA
Forward Voltage		V _F	1.7	2.1	2.4	V	I _F =20mA
Reverse Current		I _R	----	----	10	μA	V _R =5V



Technical Data Sheet

0.56" Quadruple Digit Displays

ELF-511GWA

■ Typical Electro-Optical Characteristic Curves:

GHIP Material:Gap
Emitted Color:Yellow Green

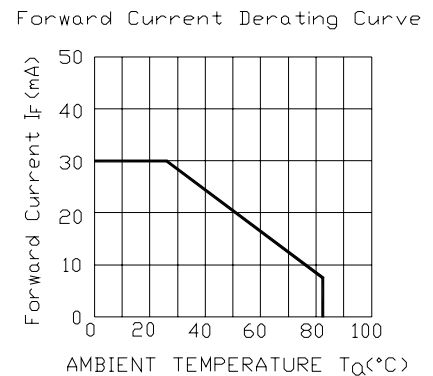
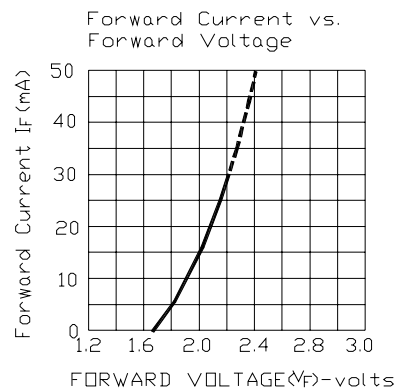
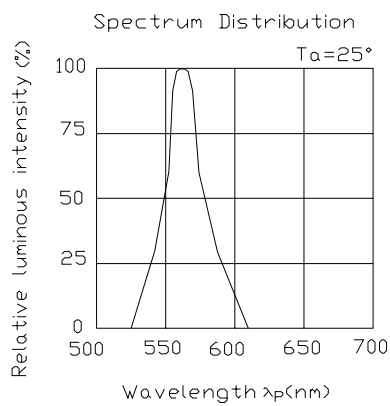

Technical Data Sheet
0.56" Quadruple Digit Displays
ELF-511GWA
Reliability test items and conditions:

NO	Item	Test Conditions	Test Hours/Cycle	Sample Size	Ac/Re
1	Solder Heat	TEMP : 260°C ± 5 °C	5 SEC	76 PCS	0/1
2	Temperature Cycle	H : +85°C 30min ∫ 5 min L : -55°C 30min	50 CYCLE	76 PCS	0/1
3	Thermal Shock	H : +100°C 5min ∫ 10 sec L : -10°C 5min	50 CYCLE	76 PCS	0/1
4	High Temperature Storage	TEMP : 100°C	1000 HRS	76 PCS	0/1
5	Low Temperature Storage	TEMP : -55°C	1000 HRS	76 PCS	0/1
6	DC Operating Life	IF = 10 mA	1000 HRS	76 PCS	0/1
7	High Temperature / High Humidity	85°C/85% RH	1000 HRS	76 PCS	0/1