

**Features**

- 5A peak, 2A continuous output current
- 10 V/ $\mu$ s slew rate
- 300 kHz power bandwidth
- 850 mW standby power ( $\pm 15$ V supplies)
- 300 pA input bias current
- Virtually no crossover distortion
- 2  $\mu$ s settling time to 0.01%
- 5 MHz gain bandwidth
- MIL-STD-883 devices 100% manufactured in U.S.A.

**Ordering Information**

Part No.	Temp. Range	Package Outline #
ELH0101AK/883B	-55°C to +125°C	TO-3 MDP0003
ELH0101K/883B	-55°C to +125°C	TO-3 MDP0003

8508901YX and 8508902YX are the SMD versions of this device.

**Connection Diagram**

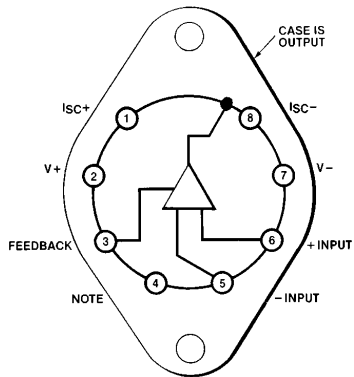

**Top View**

Note: Electrically connected internally. No connection should be made to pin.

0101-1

**General Description**

The ELH0101 is a wideband power operational amplifier featuring FET inputs, internal compensation, virtually no crossover distortion, and rapid settling time. These features make the ELH0101 an ideal choice for DC or AC servo amplifiers, deflection yoke drivers, programmable power supplies, and disk head positioner amplifiers.

Elantec facilities comply with MIL-I-45208A and other applicable quality specifications. Elantec's Military devices are 100% fabricated and assembled in our rigidly controlled, ultra-clean facilities in Milpitas, California. For additional information on Elantec's Quality and Reliability Assurance policy and procedures request brochure QRA-1.

**Equivalent Schematic**

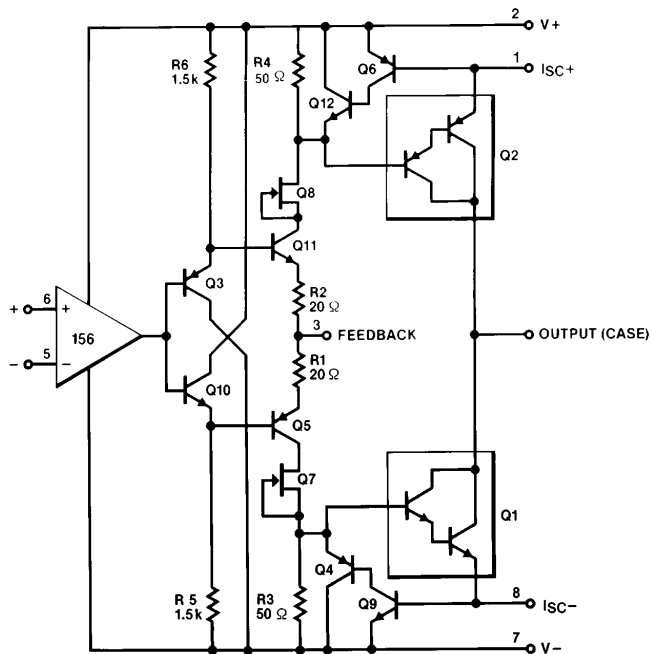

0101-2

Note: All information contained in this data sheet has been carefully checked and is believed to be accurate as of the date of publication; however, this data sheet cannot be a "controlled document". Current revisions, if any, to these specifications are maintained at the factory and are available upon your request. We recommend checking the revision level before finalization of your design documentation. Patent pending.

# ELH0101/883/8508901/2YX

## Power Operational Amplifier

### Absolute Maximum Ratings

$V_S$	Supply Voltage ELH0101, ELH0101A	$\pm 22V$	$V_{IN}$	Input Voltage Range ELH0101, ELH0101A	$\pm 20V$ but $< \pm V_S$
$P_D$	Power Dissipation at $T_A = 25^\circ C$ Derate linearly at $25^\circ C/W$ to zero at $150^\circ C$	5W		Peak Output Current (50 ms pulse)	5A
$P_D$	Power Dissipation at $T_C = 25^\circ C$ Derate linearly at $2^\circ C/W$ to zero at $150^\circ C$	62W		Output Short Circuit Duration (within rated power dissipation, $R_{SC} = 0.35\Omega$ , $T_A = 25^\circ C$ )	Continuous
	Differential Input Voltage ELH0101, ELH0101A	$\pm 40V$ but $< \pm V_S$	$T_A$	Operating Temperature Range: ELH0101, ELH0101A	$-55^\circ C$ to $+125^\circ C$
			$T_J$	Maximum Junction Temperature	$150^\circ C$
			$T_{ST}$	Storage Temperature Lead Temperature (Soldering, 10 seconds)	$-65^\circ C$ to $+150^\circ C$  $300^\circ C$

#### Important Note:

All parameters having Min/Max specifications are guaranteed. The Test Level column indicates the specific device testing actually performed during production and Quality inspection. Elantec performs most electrical tests using modern high-speed automatic test equipment, specifically the LTX77 Series system. Unless otherwise noted, all tests are pulsed tests, therefore  $T_J = T_C = T_A$ .

Test Level	Test Procedure
I	100% production tested and QA sample tested per QA test plan QCX0002.
II	100% production tested at $T_A = 25^\circ C$ and QA sample tested at $T_A = 25^\circ C$ , $T_{MAX}$ and $T_{MIN}$ per QA test plan QCX0002.
III	QA sample tested per QA test plan QCX0002.
IV	Parameter is guaranteed (but not tested) by Design and Characterization Data.
V	Parameter is typical value at $T_A = 25^\circ C$ for information purposes only.

### DC Electrical Characteristics (Note 1) $V_S = \pm 15V$ , $T_A = 25^\circ C$ , $V_{CM} = 0V$

Parameter	Description	Test Conditions	ELH0101			ELH0101A			Test Level	Units
			Min	Typ	Max	Min	Typ	Max		
$V_{OS}$	Input Offset Voltage			1	10		1	3	I	mV
		$T_{MIN} \leq T_A \leq T_{MAX}$ , ELH0101			15			7	I	mV
$\Delta V_{OS}/\Delta P_D$	Change in Input Offset Voltage with Dissipated Power	(Note 2)		150			150		V	$\mu V/W$
$\Delta V_{OS}/\Delta T$	Change in Input Offset Voltage with Temperature			10			10		V	$\mu V/^\circ C$
$I_B$	Input Bias Current				1,000			300	I	pA
		$T_A \leq T_{MAX}$ , ELH0101			1,000			300	I	nA

# ELH0101/883/8508901/2YX

## Power Operational Amplifier

### DC Electrical Characteristics (Note 1) $V_S = \pm 15V$ , $T_A = 25^\circ C$ , $V_{CM} = 0V$ — Contd.

Parameter	Description	Test Conditions	ELH0101			ELH0101A			Test Level	Units
			Min	Typ	Max	Min	Typ	Max		
I <sub>OS</sub>	Input Offset Current				250			75	I	pA
		$T_A \leq T_{MAX}$ , ELH0101, A			250			75	I	nA
AVOL	Large Signal Voltage Gain	$V_O = \pm 10V$ , $R_L = 10\Omega$	50	200		50	200		I	V/mV
V <sub>O</sub>	Output Voltage Swing	$R_{SC} = 0\Omega$ , $A_V = 1$ , $R_L = 100\Omega$ (Note 3)	$\pm 11.7$	$\pm 12.5$		$\pm 11.7$	$\pm 12.5$		I	V
		$R_{SC} = 0\Omega$ , $A_V = 1$ , $R_L = 10\Omega$ (Note 3)	$\pm 11$	$\pm 11.6$		$\pm 11$	$\pm 11.6$		I	V
		$R_{SC} = 0\Omega$ , $A_V = 1$ , $R_L = 5\Omega$ (Note 3)	$\pm 10.5$	$\pm 11$		$\pm 10.5$	$\pm 11$		I	V
CMRR	Common-Mode Rejection Ratio	$V_{IN} = \pm 10V$	85	100		85	100		I	dB
PSRR	Power Supply Rejection Ratio	$\pm 5V \leq V_S \leq \pm 15V$	85	100		85	100		I	dB
		$+5V \leq V_S(+)$ $\leq +15V$ , $V_S(-) = -15V$	80	110		80	110		I	dB
		$-5V \geq V_S(-)$ $\geq -15V$ , $V_S(+)$ $= +15V$	80	95		80	95		I	dB
I <sub>S</sub>	Supply Current		28	35		28	35		I	mA

### AC Electrical Characteristics $V_S = \pm 15V$ , $T_A = T_C = T_J = 25^\circ C$

Parameter	Description	Test Conditions	ELH0101			ELH0101A			Test Level	Units
			Min	Typ	Max	Min	Typ	Max		
e <sub>n</sub>	Equivalent Input Noise Voltage	$f = 1\text{ kHz}$		25			25		V	nV/ $\sqrt{\text{Hz}}$
C <sub>IN</sub>	Input Capacitance	$f = 1\text{ MHz}$		3			3		V	pF
PBW	Power Bandwidth, -3 dB	$R_L = 10\Omega$ , $A_V = 1$		300			300		V	kHz
SR	Slew Rate	$R_L = 10\Omega$ , $A_V = 1$ ELH0101AK	7.5	10		7.5	10		I	V/ $\mu s$
t <sub>r</sub> , t <sub>f</sub>	Small Signal Rise or Fall Time	$R_L = 10\Omega$ , $A_V = 1$		200			200		V	ns
	Small Signal Overshoot	$R_L = 10\Omega$ , $A_V = 1$		10			10		V	%

# **ELH0101/883/8508901/2YX**

## **Power Operational Amplifier**

### AC Electrical Characteristics $V_S = \pm 15V, T_A = T_C = T_J = 25^\circ C$ — Contd.

Parameter	Description	Test Conditions	ELH0101			ELH0101A			Test Level	Units
			Min	Typ	Max	Min	Typ	Max		
GBW	Gain-Bandwidth Product	$R_L = \infty, A_V = 1$ ELH0101AK	4	5		4	5		I	MHz
$t_S$	Large Signal Settling Time (0.01%)	$R_L = \infty, A_V = 1$		2			2		V	$\mu s$
THD	Total Harmonic Distortion	$f = 1 \text{ kHz}, P_O = 0.5W,$ $R_L = 10\Omega$		0.008			0.008		V	%

Note 1: Specification is at  $T_A = 25^\circ C$ . Actual values at operating temperature may differ from the  $T_A = 25^\circ C$  value. When supply voltages are  $\pm 15V$ , quiescent operating junction temperature will rise approximately  $20^\circ C$  without heatsinking. Accordingly,  $V_{OS}$  may change 0.5 mV and  $I_B$  and  $I_{OS}$  will change significantly during warm-ups. Refer to  $I_B$  vs. temperature and power dissipation graphs for expected values.

Note 2: Change in offset voltage with dissipated power is due entirely to average device temperature rise and not to differential thermal feedback effects. Test is performed without any heatsink.

Note 3: At light loads, the output swing may be limited by the second stage rather than the output stage. See the application section under "Output swing enhancement" for hints on how to obtain extended operation.  $R_{SC}$  is the current sense resistor.

# ELH0101/883/8508901/2YX

## Power Operational Amplifier

### Typical Performance Curves

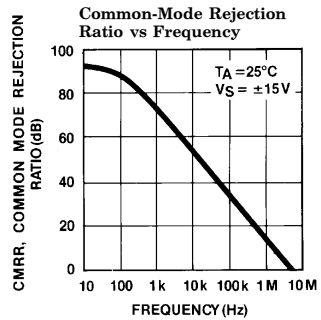
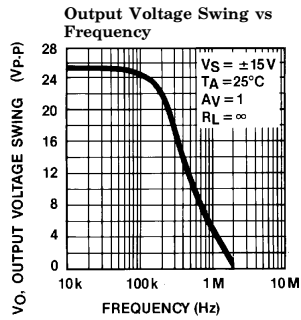
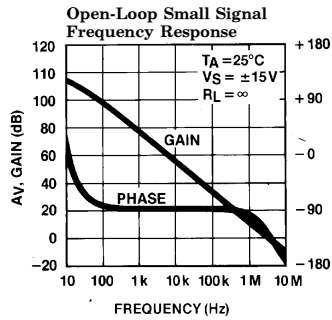
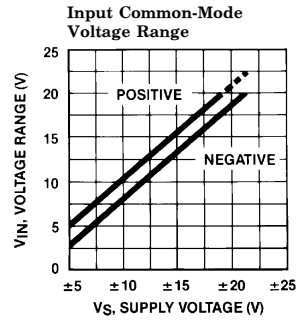
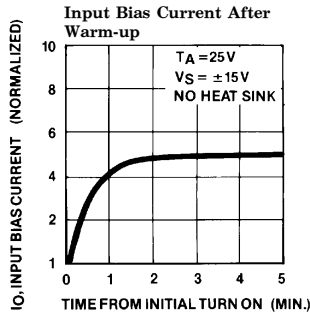
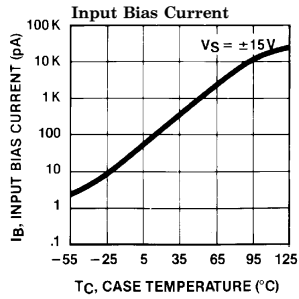
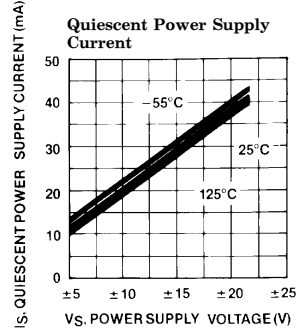
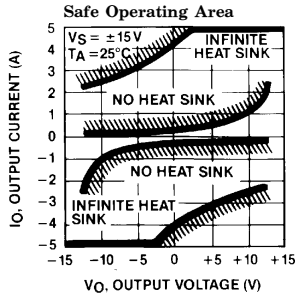
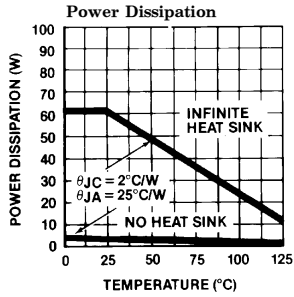

0101-3

# ELH0101/883/8508901/2YX

## Power Operational Amplifier

### Typical Performance Curves — Contd.

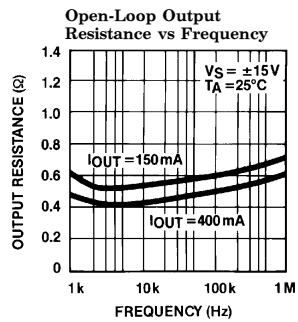
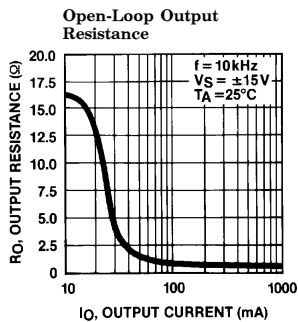
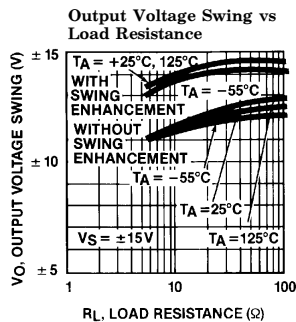
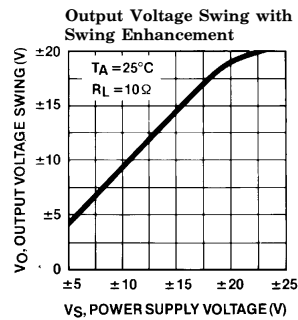
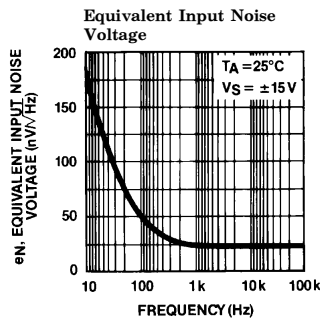
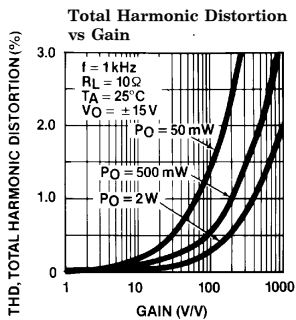
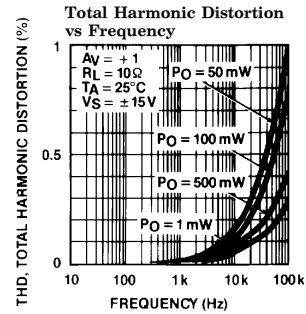
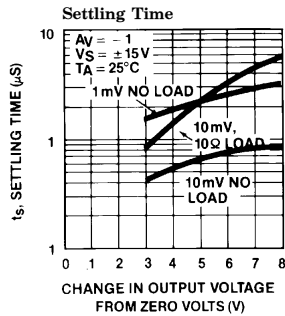
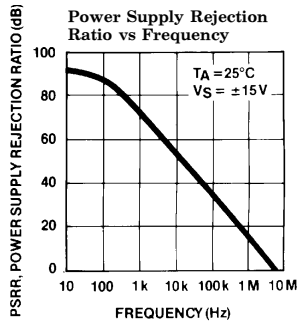

0101-4

# ELH0101/883/8508901/2YX

## Power Operational Amplifier

### Typical Performance Curves — Contd.

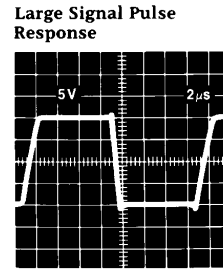
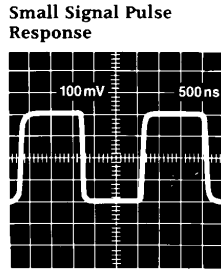
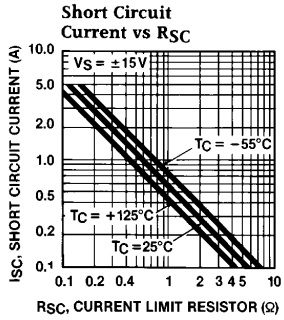

0101-5

### Typical Applications

#### High Power Voltage Follower

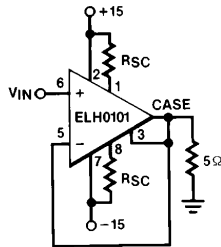

0101-6

#### High Power Voltage Follower with Swing Enhancement

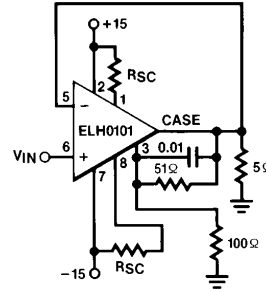

0101-7

#### Restricting Outputs to Positive Voltage Only

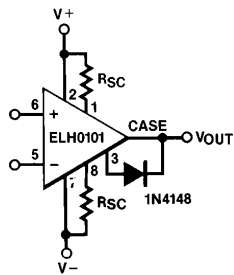

0101-8

#### Generating a Split Supply from a Single Voltage Supply

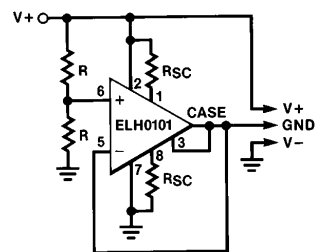

0101-9

# ELH0101/883/8508901/2YX

## Power Operational Amplifier

### Typical Applications — Contd.

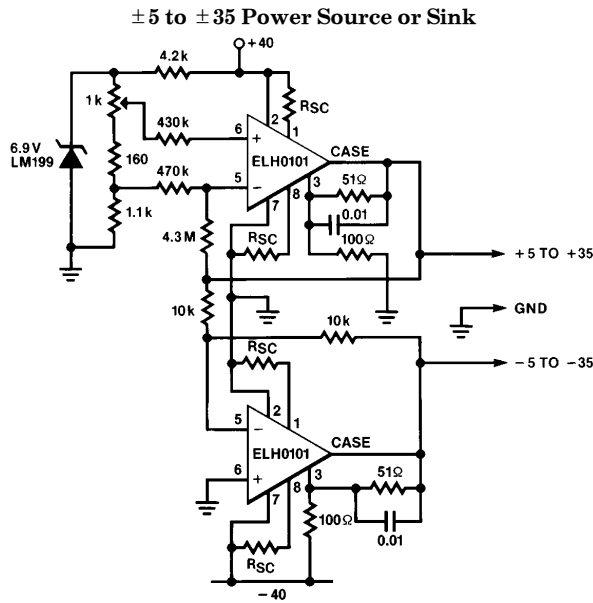

### CRT Deflection Yoke Driver

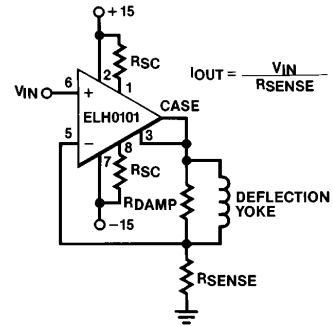

0101-11

### DC Servo Amplifier

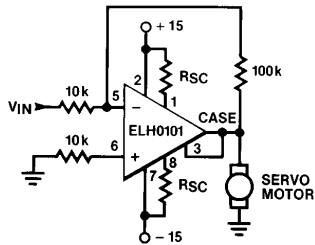

0101-12

### High Current Source/Sink

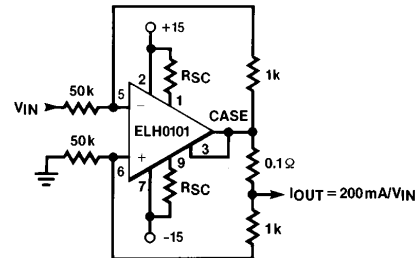

0101-13



# *ELH0101/883/8508901/2YX*

## *Power Operational Amplifier*

### **Applications Information**

#### **Input Voltages**

The ELH0101 operational amplifier contains JFET input devices which exhibit high reverse breakdown voltages from gate to source or drain. This eliminates the need for input clamp diodes, so that high differential input voltages may be applied without a large increase in input current. However, neither input voltage should be allowed to exceed the negative supply as the resultant high current flow may destroy the unit.

Exceeding the negative common-mode limit on either input will cause a reversal of the phase to the output and force the amplifier output to the corresponding high or low state. Exceeding the negative common-mode limit on both inputs will force the amplifier output to a high state. In neither case does a latch occur since raising the input back within the common-mode range again puts the input stage and thus the amplifier in a normal operating mode.

Exceeding the positive common-mode limit on a single input will not change the phase of the output, however; if both inputs exceed the limit, the output of the amplifier will be forced to a high state.

These amplifiers will operate with the common-mode input voltage equal to the positive supply. In fact, the common-mode voltage may exceed the positive supply by approximately 100 mV, independent of supply voltage and over the full operating temperature range. The positive supply may therefore be used as a reference on an input as, for example, in a supply current monitor and/or limiter.

With the ELH0101 there is a temptation to remove the bias current compensation resistor normally used on the non-inverting input of a summing amplifier. Direct connection of the inputs to ground or a low-impedance voltage source is not recommended with supply voltages greater than 3V. The potential problem involves loss of

one supply which can cause excessive current in the second supply. Destruction of the IC could result if the current to the inputs of the device is not limited to less than 100 mA or if there is much more than 1  $\mu$ F bypass on the supply bus.

Although difficulties can be largely avoided by installing clamp diodes across the supply lines on every PC board, a conservative design would include enough resistance in the input lead to limit current to 10 mA if the input lead is pulled to either supply by internal currents. This precaution is by no means limited to the ELH0101.

#### **Layout Considerations**

When working with circuitry capable of resolving picoampere level signals, leakage currents in circuitry external to the op amp can significantly degrade performance. High quality insulation is a must (Kel-F and Teflon rate high). Proper cleaning of all insulating surfaces to remove fluxes and other residues is also required. This includes the IC package as well as sockets and printed circuit boards. When operating in high humidity environments or near 0°C, some form of surface coating may be necessary to provide a moisture barrier.

The effects of board leakage can be minimized by encircling the input circuitry with a conductive guard ring operated at a potential close to that of the inputs.

Electrostatic shielding of high impedance circuitry is advisable.

Error voltages can also be generated in the external circuitry. Thermocouples formed between dissimilar metals can cause hundreds of microvolts of error in the presence of temperature gradients.

Since the ELH0101 can deliver large output currents, careful attention should be paid to power supply, power supply bypassing and load currents. Incorrect grounding of signal inputs and load can cause significant errors.

# ELH0101/883/8508901/2YX

## Power Operational Amplifier

### Applications Information — Contd.

Every attempt should be made to achieve a single point ground system as shown in the figure below.

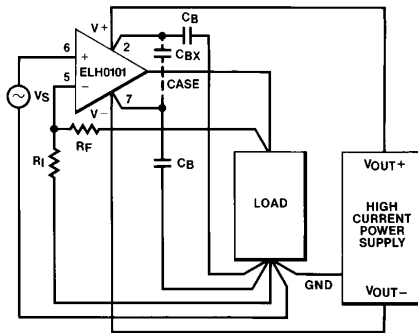

0101-14

Bypass capacitor  $C_{BX}$  should be used if the lead lengths of bypass capacitors  $C_B$  are long. If a single point ground system is not possible, keep signal, load, and power supply from intermingling as much as possible. For further information on proper grounding techniques refer to "Grounding and Shielding Techniques in Instrumentation" by Morrison, and "Noise Reduction Techniques in Electronic Systems" by Ott (both published by John Wiley and Sons).

Leads or PC board traces to the supply pins, short circuit current limit pins, and the output pin must be substantial enough to handle the high currents that the ELH0101 is capable of producing.

### Short Circuit Current Limiting

Should current limiting of the output not be necessary, SC+ should be shorted to V+ and SC- should be shorted to V-. Remember that the short circuit current limit is dependent upon the total resistance seen between the supply and current limit pins. This total resistance includes the desired resistor plus leads, PC Board traces, and solder joints.\* Assuming a zero TCR current limit resistor, typical temperature coefficient of the short circuit will be approximately 0.3%.

### Thermal Resistance

The thermal resistance between two points of a conductive system is expressed as:

$$\theta_{12} = \frac{T_1 - T_2}{P_D} \text{ } ^\circ\text{C/W} \quad (1)$$

where subscript order indicates the direction of heat flow. A simplified heat transfer circuit for a cased semiconductor and heatsink system is shown in the figure below.

The circuit is valid only if the system is in thermal equilibrium (constant heat flow) and there are, indeed, single specific temperatures,  $T_J$ ,  $T_C$ , and  $T_S$ , (no temperature distribution in junction, case, or heatsink). Nevertheless, this is a reasonable approximation of actual performance.

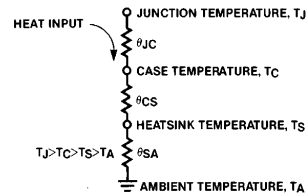

0101-15

\*Short circuit current will be limited to approximately  $\frac{0.6}{RSC}$ .

The junction-to-case thermal resistance,  $\theta_{JC}$ , specified in the data sheet depends upon the material and size of the package, die size and thickness, and quality of the die bond to the case or lead frame. The case-to-heatsink thermal resistance,  $\theta_{CS}$ , depends on the mounting of the device to the heatsink and upon the area and quality of the contact surface. Typical  $\theta_{CS}$  for a TO-3 package is  $0.5^\circ\text{C/W}$  to  $0.7^\circ\text{C/W}$ , and  $0.3^\circ\text{C/W}$  to  $0.5^\circ\text{C/W}$  using silicone grease.

The heatsink to ambient thermal resistance,  $\theta_{SA}$ , depends on the quality of the heatsink and the ambient conditions.

# ELH0101/883/8508901/2YX

## Power Operational Amplifier

### Application Information — Contd.

Cooling is normally required to maintain the worst case operating junction temperature,  $T_J$ , of the device below the specified maximum value,  $T_{J(MAX)}$ .  $T_J$  can be calculated from known operating conditions. Rewriting equation (1), we find:

$$\theta_{JA} = \frac{T_J - T_A}{P_D} \text{ } ^\circ\text{C/W}$$

$$T_J = T_A + P_D \theta_{JA} \text{ } ^\circ\text{C}$$

$$\text{Where: } P_D = (V_S - V_{OUT}) I_{OUT} + |V_{\pm} (V^-)| I_Q$$

$$\theta_{JA} = \theta_{JC} + \theta_{CS} + \theta_{SA} \text{ and}$$

$$V_S = \text{Supply Voltage}$$

$\theta_{JC}$  for the ELH0101 is typically  $2^\circ\text{C/W}$ .

### Stability and Compensation

As with most amplifiers, care should be taken with lead dress, component placement and supply decoupling in order to ensure stability. For example, resistors from the output to an input should be placed with the body close to the input to minimize "pickup" and maximize the frequency of the feedback pole by minimizing the capacitance from the input to ground.

A feedback pole is created when the feedback around any amplifier is resistive. The parallel resistance and capacitance from the input of the device (usually the inverting input) to AC ground set the frequency of the pole. In many instances the frequency of this pole is much greater than the expected 3 dB frequency of the closed loop gain and consequently there is negligible effect on stability margin. However, if the feedback pole is less than approximately six times the expected 3 dB frequency, a lead capacitor should be placed from the output to the input of the op amp. The value of the added capacitor should be such that the RC time constant of this capacitor and the resistance it parallels is greater than or equal to the original feedback pole time constant.

Some inductive loads may cause output stage oscillation. A  $0.01 \mu\text{F}$  ceramic capacitor in series with a  $10\Omega$  resistor from the output to ground will usually remedy this situation.

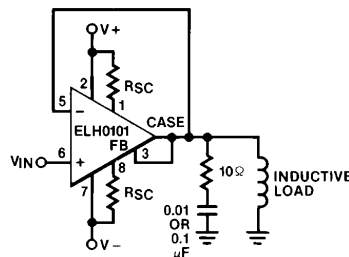

0101-16

Capacitive loads may be compensated for by traditional techniques. (See "Operational Amplifiers: Theory and Practice" by Roberge, published by Wiley.)

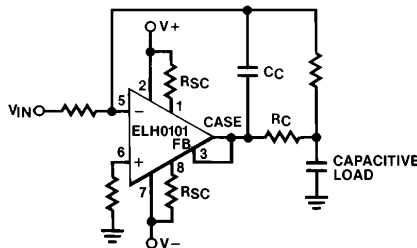

0101-17

A similar but alternative technique may be used for the ELH0101.

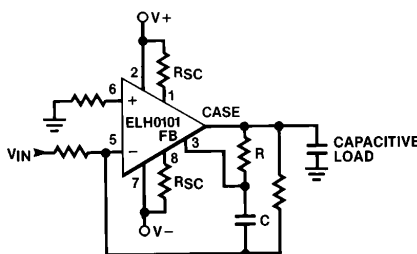

0101-18

# ***ELH0101/883/8508901/2YX***

## ***Power Operational Amplifier***

### **Output Swing Enhancement**

When the feedback pin is connected directly to the output, the output voltage swing is limited by the driver stage and not by output saturation. Output swing can be increased by taking gain in the output stage as shown below in the High Power Voltage Follower with Swing Enhancement. Whenever gain is taken in the output stage, either the output stage, or the entire op

amp must be appropriately compensated to account for the additional loop gain.

### **Output Resistance**

The open-loop output resistance of the ELH0101 is a function of the load current. No-load output resistance is approximately  $10\Omega$ . This decreases to under an  $\Omega$  for load currents exceeding 100 mA.

### **Burn-In Circuit**

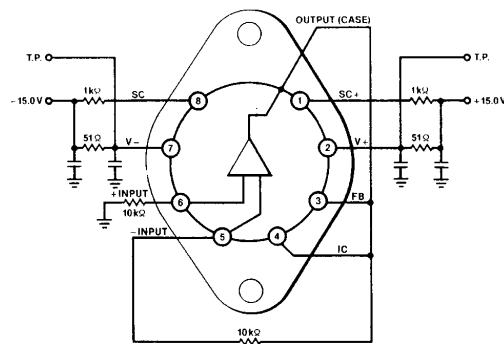

0101-19

# *ELH0101/883/8508901/2YX*

## *Power Operational Amplifier*

### ELH0101 Macromodel

```

* Connections: + input
*               |      -Input
*               |      V+
*               |      |      Isc+
*               |      |      Feedback
*               |      |      V-
*               |      |      Isc-
*               |      |      Output
*               |      |
* em0101        6      5      2      1      3      7      8      4
.subckt buffer 21      2      1      3      7      8      4
* Resistors
r1 3 27 10
r2 26 3 10
r3 30 7 50
r4 2 23 50
r5 29 7 2K
r6 2 22 2K
r7 27 28 10
r8 24 26 10
* Transistors
q1 4 30 8 qnd
d1 8 4 dclamp
q2 4 23 1 qpd
d2 4 1 dclamp
q3 7 21 22 qp
q4 23 22 24 qn
q5 21 21 26 qn
q6 23 1 2 qp
q7 2 21 29 qn
q8 27 27 21 qn
q9 30 29 28 qp
q10 30 8 7 qn
* Models
.model qpd pnp (is = 88.013e-12 ikf = 5A tf = 32nS vaf = 50V cje = 45pF cjc = 60pF
+ xtb = 2.1 bf = 12000 ne = 4 ise = 1e-10)
.model qnd npn (is = 88.013e-12 ikf = 5A tf = 32nS vaf = 50V cje = 45pF cjc = 60pF
+ xtb = 2.1 bf = 12000 ne = 4 isc = 1e-10)
.model dclamp d (is = 10e-28 tt = 100nS)

```

# ***ELH0101/883/8508901/2YX***

## ***Power Operational Amplifier***

### **ELH0101 Macromodel — Contd.**

```
.model qp pnp (is = 10e-15 xti = 3 eg = 1.11V vaf = 91V bf = 200 ne = 2.321 ise = 6.2fA
+ ikf = 500mA xtb = 2.1 br = 3.3 nc = 2 cjc = 14.6pF vjc = 0.75V mjc = 0.3333 fc = 0.5 cje = 20pF
+ vje = 0.75V mje = 0.3333 tr = 29nS tf = 0.4nS itf = 0.4 vtf = 10 xtf = 2 rb = 10)
.model qn npn (is = 3e-15 xti = 3 eg = 1.11V vaf = 151V bf = 220 ne = 1.541 ise = 14fA
+ ikf = 500mA xtb = 2.1 br = 6 nc = 2 cjc = 14.6pF vjc = 0.75V mjc = 0.3333 fc = 0.5 cje = 26pF
+ vje = 0.75V mje = 0.3333 tr = 51nS tf = 0.4nS itf = 0.6 vtf = 1.7 xtf = 2 rb = 10)
.ends buffer
* lf156 Subcircuit
* Connections:
*
*      + Input
*      |
*      |      - Input
*      |      |
*      |      |      V+
*      |      |      |
*      |      |      |      V-
*      |      |      |      |
*      |      |      |      |      Output
*      |      |      |      |
*
.subckt lf156 6 5 2 7 21
* Input Stage
vcm2 40 7 2
rd1 40 80 1.06K
rd2 40 90 1.06K
j1 80 102 12 jm1
j2 90 103 12 jm2
cin 5 6 4pF
rg1 5 102 2
rg2 6 103 2
* CM Clamp
dcm1 107 103 dm4
dcm2 105 107 dm4
vcmc 105 7 4V
ecmp 106 7 103 7 1
rcmp 107 106 10K
dcm3 109 102 dm4
dcm4 105 109 dm4
ecmn 108 2 102 2 1
rcmn 109 108 10K
cl 80 90 15pF
iss 2 12 0.48mA
gosit 2 12 90 80 2.4e-4
* Intermediate Stage
gcm 0 88 12 0 9.425e-9
ga 88 0 80 90 9.425e-4
r2 88 0 100K
c2 91 88 30pF
gb 91 0 88 0 28.6
ro2 91 0 74
```

# *ELH0101/883/8508901/2YX*

## *Power Operational Amplifier*

### **ELH0101 Macromodel — Contd.**

\* Output Stage

```
rso 91 21 1
ecl 18 0 91 21 20.69
gcl 0 88 20 0 1
rcl 20 0 1K
d1 18 20 dm1
d2 20 18 dm1
d3a 131 70 dm3
d3b 13 131 dm3
gpl 0 88 70 2 1
vc 13 21 3.1552V
rpla 2 70 10K
rplb 2 131 100K
d4a 60 141 dm3
d4b 141 14 dm3
gnl 0 88 60 7 1
ve 21 14 3.1552V
rnla 60 7 10K
rnlb 141 7 100K
ip 2 7 4.52mA
dsub 7 2 dm2
```

\* Models

```
.model jm1 pjf (is=3.15e-11 beta=9.2528e-4 vto=-1.0)
.model jm2 pjf (is=2.85e-11 beta=9.2528e-4 vto=-0.999)
.model dm1 d (is=1.0e-15)
.model dm2 d (is=8.0e-16 bv=52.8)
.model dm3 d (is=1.0e-16)
.model dm4 d (is=1.0e-9)
ends lf156
```

\* lf156 model courtesy of Linear Technology Corp.

# ELH0101/883/8508901/2YX

## Power Operational Amplifier

ELH0101 Macromodel — Contd.

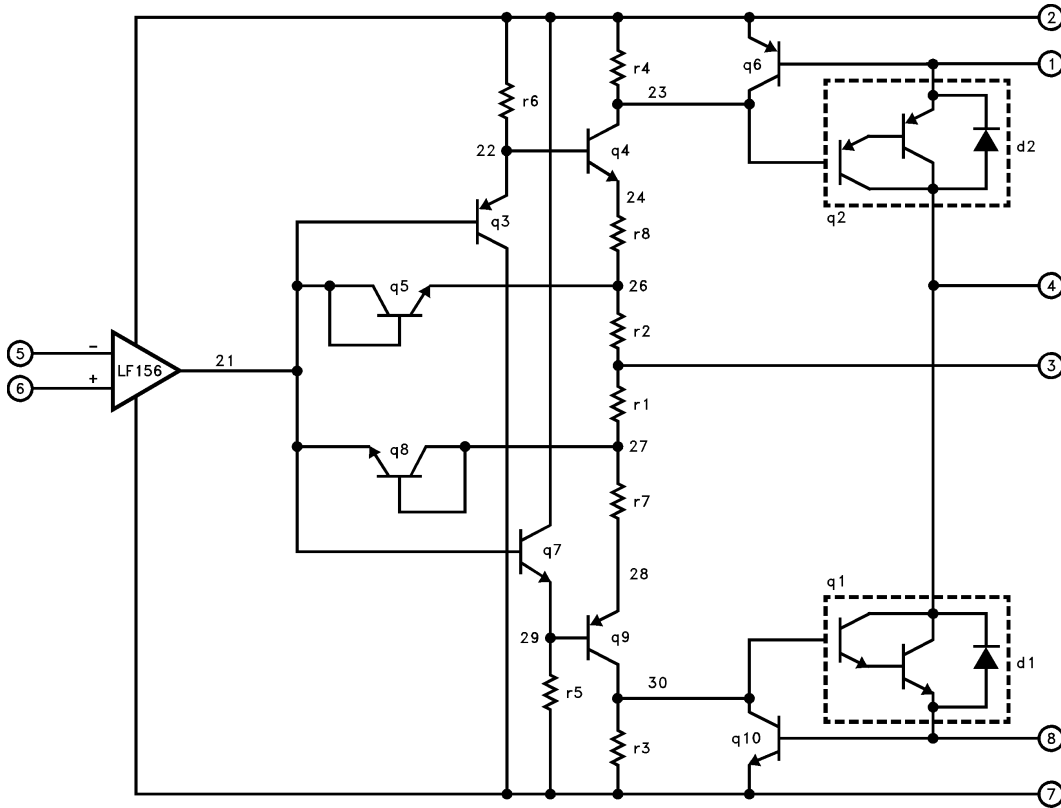

0101-20

**General Disclaimer**

Specifications contained in this data sheet are in effect as of the publication date shown. Elantec, Inc. reserves the right to make changes in the circuitry or specifications contained herein at any time without notice. Elantec, Inc. assumes no responsibility for the use of any circuits described herein and makes no representations that they are free from patent infringement.



**Elantec, Inc.**  
 1996 Tarob Court  
 Milpitas, CA 95035  
 Telephone: (408) 945-1323  
 (800) 333-6314  
 Fax: (408) 945-9305  
 European Office: 44-71-482-4596

**WARNING — Life Support Policy**

Elantec, Inc. products are not authorized for and should not be used within Life Support Systems without the specific written consent of Elantec, Inc. Life Support systems are equipment intended to support or sustain life and whose failure to perform when properly used in accordance with instructions provided can be reasonably expected to result in significant personal injury or death. Users contemplating application of Elantec, Inc. products in Life Support Systems are requested to contact Elantec, Inc. factory headquarters to establish suitable terms & conditions for these applications. Elantec, Inc.'s warranty is limited to replacement of defective components and does not cover injury to persons or property or other consequential damages.