

ELM97xxxxA VOLTAGE DETECTOR

■ GENERAL DESCRIPTION

ELM 97xxxxA Series is a CMOS voltage detector IC for battery-operated portable devices. It consists of a very low-power-consumption reference voltage source, a comparator, an output driver, a hysteresis circuit, and detection voltage setting resistors. Output logic is positive, therefore output level is low when VDD is lower than detection voltage.

It can be used as a reset controller in microcomputer-based systems. And it can be widely applied to the devices, such as battery checkers, switching circuit of back-up power source, power failure detectors, etc.

Two output styles are available, N-ch opendrain and CMOS output.

It is available in SOT-89 and SOT-23.

■ FEATURES

- Low power operation : TYP. 1.0 μ A (VDD = 1.5V)
- Low voltage operation : Reset operation assured at 0.8V
- High accuracy of detection voltage : $\pm 2.5\%$
- Low temperature coefficient : TYP. -300ppm/ $^{\circ}$ C (Detection voltage < 2.0V)
: TYP. -100ppm/ $^{\circ}$ C (Detection voltage $\geq 2.0V$)
- Very small package : SOT-89, SOT-23

■ APPLICATION

- Reset for microcomputer
- Battery checker
- Power failure detector
- Switching of back-up power source

■ PIN CONFIGURATION

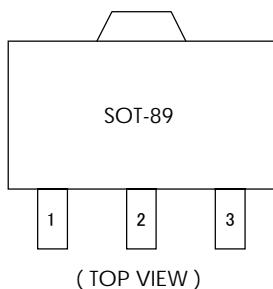

Pin No.	Pin Name
1	OUT
2	VDD
3	VSS

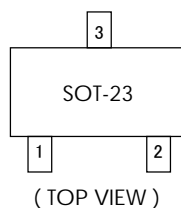

Pin No.	Pin Name
1	OUT
2	VSS
3	VDD

VOLTAGE DETECTOR ELM97xxxxA

■ SELECTION GUIDE

Symbol		
a, b	Detection Voltage	Ex 09 : VDET _N = 0.9V 27 : VDET _N = 2.7V 45 : VDET _N = 4.5V
c	Output Form	C : CMOS Output N : N-ch Opendrain Output
d	Package	A : SOT-89 B : SOT-23
e	Product Version	A : A Version

ELM97 x x x x A
 ↑ ↑ ↑ ↑ ↑
 a b c d e

■ SERIES

Model	Detection Voltage	Output Form	Package	Model	Detection Voltage	Output Form	Package
ELM9709NBA-S(N)	0.9V	N-ch	SOT-23	ELM9727CAA-S(N)	2.7V	CMOS	SOT-89
ELM9710NBA-S(N)	1.0V	N-ch	SOT-23	ELM9730CAA-S(N)	3.0V	CMOS	SOT-89
ELM9711NBA-S(N)	1.1V	N-ch	SOT-23	ELM9732CAA-S(N)	3.2V	CMOS	SOT-89
ELM9722CAA-S(N)	2.2V	CMOS	SOT-89	ELM9734CAA-S(N)	3.4V	CMOS	SOT-89
ELM9724CAA-S(N)	2.4V	CMOS	SOT-89	ELM9745CAA-S(N)	4.5V	CMOS	SOT-89
ELM9725CAA-S(N)	2.5V	CMOS	SOT-89	ELM9748CAA-S(N)	4.8V	CMOS	SOT-89

S type : Standard, N type : Reverse

* Available 0.9V~5.0V detection voltage for N-ch output and 2.0V~5.0V detection voltage for CMOS output at 0.1V step as semi-custom-made IC.

VOLTAGE DETECTOR ELM97xxxxA

MARKING

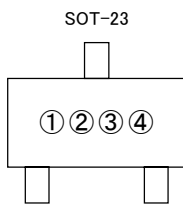
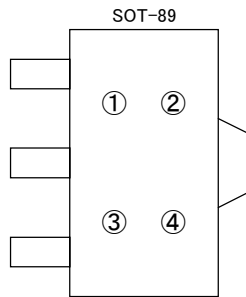

Rule 1

①: Represents the integer digit of the detection voltage

Symbol	Detection Voltage	Symbol	Detection Voltage
A	0.*V (N-ch)	P	2.*V (CMOS)
B	1.*V (N-ch)	R	3.*V (CMOS)
C	2.*V (N-ch)	S	4.*V (CMOS)
D	3.*V (N-ch)	T	5.*V (CMOS)
E	4.*V (N-ch)		
F	5.*V (N-ch)		

②: Represents the decimal digit of the detection voltage

Symbol	Detection Voltage	Symbol	Detection Voltage
0	*.0V	5	*.5V
1	*.1V	6	*.6V
2	*.2V	7	*.7V
3	*.3V	8	*.8V
4	*.4V	9	*.9V

③: Represents the assembly lot number
A ~ Z repeated (I,O,X excepted)

④: Represents the assembly lot number
0 ~ 9 repeated

Rule 2

①: Represents the ELM97xxxxA series
ELM97xxxxA series = A

②: Represents the integer digit of the detection voltage

Symbol	Detection Voltage	Symbol	Detection Voltage
0	0.*V (N-ch)	Y	2.*V (CMOS)
1	1.*V (N-ch)	W	3.*V (CMOS)
2	2.*V (N-ch)	U	4.*V (CMOS)
3	3.*V (N-ch)	V	5.*V (CMOS)
4	4.*V (N-ch)		
5	5.*V (N-ch)		

③: Represents the decimal digit of the detection voltage

Symbol	Detection Voltage	Symbol	Detection Voltage
0	*.0V	5	*.5V
1	*.1V	6	*.6V
2	*.2V	7	*.7V
3	*.3V	8	*.8V
4	*.4V	9	*.9V

④: Represents the assembly lot number
0 ~ 9, A ~ Z repeated (I,O,X excepted)

*Remarks --- ELM97xxxxA series have two kind of mraking rules each package.

VOLTAGE DETECTOR ELM97xxxxA

■ BLOCK DIAGRAM

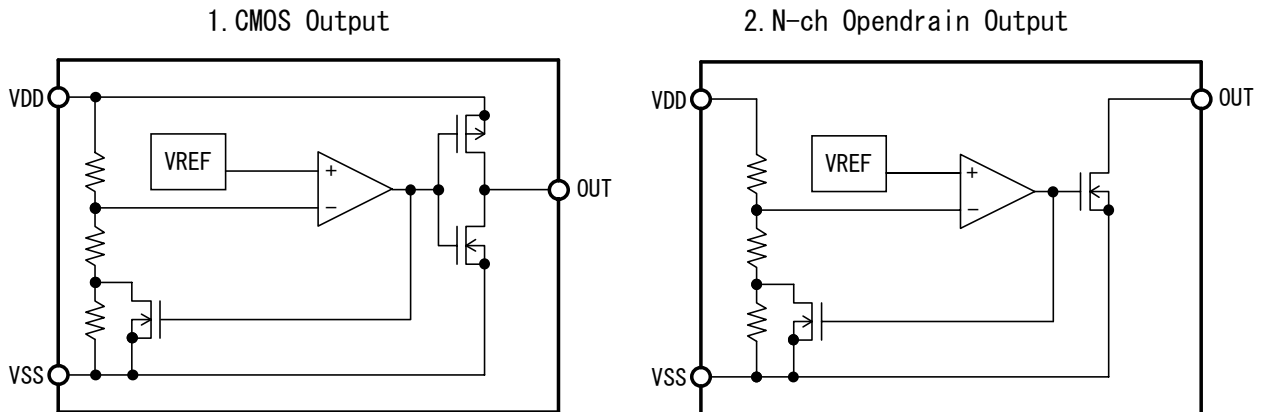

■ TIMING CHART

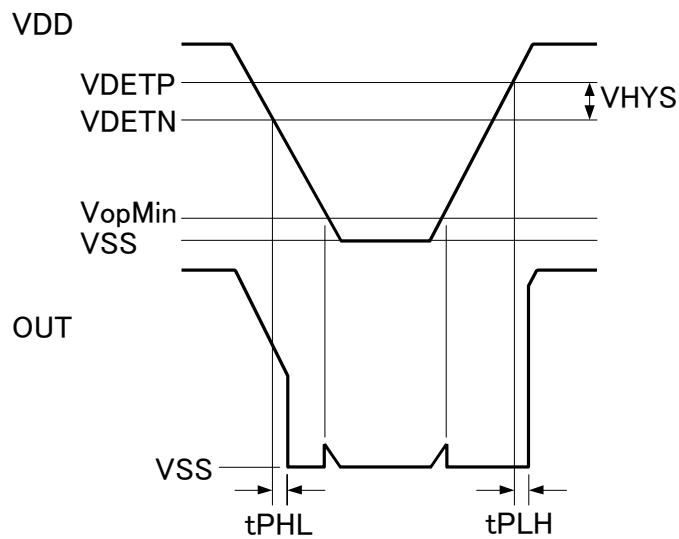

■ MAXIMUM ABSOLUTE RATINGS

(VSS=0V)				
Parameter	Symbol	Limits	Units	
Power Supply Voltage	VDD	10	V	
Output Voltage	VOUT	CMOS	VSS-0.3~VDD+0.3	V
		N-ch	VSS-0.3~+10	
Output Current	IOUT	50	mA	
Power Dissipation	Pd	SOT-89	300	mW
		SOT-23	200	
Operating Temperature	Top	-30~+80	°C	
Storage Temperature	Tstg	-40~+125		

VOLTAGE DETECTOR ELM97xxxxA

■ ELECTRICAL CHARACTERISTICS

ELM9709NBA

(Top=25°C)

Parameter	Symbol	Conditions	Min.	Typ.	Max.	Units	Remarks
Detection Voltage	VDET _N		0.878	0.900	0.922	V	2
Hysteresis width	VHYS		VDET _N × 0.02	-	VDET _N × 0.08	V	2
Current Consumption	ISS	VDD=1.5V	-	1.0	3.0	μA	1
Operating Voltage	VDD		0.8	-	6.0	V	2
Output Current	IOUT _N	VDD=0.8V, VDS=0.5V	0.02	0.1	-	mA	3
Delay Time	tPHL			2.0		mS	5
Temperature Characteristics of VDET _N	$\frac{\Delta VDET_N}{\Delta Top}$	Top=-30~+80°C	-	-0.27	-	mV/°C	-

Remarks) Test circuit No.

ELM9710NBA

(Top=25°C)

Parameter	Symbol	Conditions	Min.	Typ.	Max.	Units	Remarks
Detection Voltage	VDET _N		0.975	1.000	1.025	V	2
Hysteresis width	VHYS		VDET _N × 0.02	-	VDET _N × 0.08	V	2
Current Consumption	ISS	VDD=1.5V	-	1.0	3.0	μA	1
Operating Voltage	VDD		0.8	-	6.0	V	2
Output Current	IOUT _N	VDD=0.8V, VDS=0.5V	0.02	0.1	-	mA	3
Delay Time	tPHL			2.0		mS	5
Temperature Characteristic of VDET _N	$\frac{\Delta VDET_N}{\Delta Top}$	Top=-30~+80°C	-	-0.30	-	mV/°C	-

Remarks) Test circuit No.

ELM9711NBA

(Top=25°C)

Parameter	Symbol	Conditions	Min.	Typ.	Max.	Units	Remarks
Detection Voltage	VDET _N		1.073	1.100	1.127	V	2
Hysteresis width	VHYS		VDET _N × 0.02	-	VDET _N × 0.08	V	2
Current Consumption	ISS	VDD=1.5V	-	1.0	3.0	μA	1
Operating Voltage	VDD		0.8	-	6.0	V	2
Output Current	IOUT _N	VDD=0.8V, VDS=0.5V	0.02	0.1	-	mA	3
Delay Time	tPHL			2.0		mS	5
Temperature Characteristic of VDET _N	$\frac{\Delta VDET_N}{\Delta Top}$	Top=-30~+80°C	-	-0.33	-	mV/°C	-

Remarks) Test circuit No.

VOLTAGE DETECTOR ELM97xxxxA

ELM9722CAA

(Top=25°C)

Parameter	Symbol	Conditions	Min.	Typ.	Max.	Units	Remarks
Detection Voltage	VDET _N		2.145	2.200	2.255	V	2
Hysteresis width	VHYS		VDET _N ×0.02	-	VDET _N ×0.08	V	2
Current Consumption	ISS	VDD=3.0V	-	1.5	4.5	μA	1
Operating Voltage	VDD		0.8	-	6.0	V	2
Output Current	IOUT _N	VDD=1.5V, VDS=0.5V	1.0	2.0	-	mA	3
	IOUT _P	VDD=4.5V, VDS=2.1V	0.5	1.5	-	mA	4
Delay Time	tPHL			0.1		mS	5
Temperature Characteristic of VDET _N	$\frac{\Delta VDET_N}{\Delta T_{op}}$	T _{op} =-30~+80°C	-	-0.22	-	mV/°C	-

Remarks) Test circuit No.

ELM9724CAA

(Top=25°C)

Parameter	Symbol	Conditions	Min.	Typ.	Max.	Units	Remarks
Detection Voltage	VDET _N		2.340	2.400	2.460	V	2
Hysteresis width	VHYS		VDET _N ×0.02	-	VDET _N ×0.08	V	2
Current Consumption	ISS	VDD=3.0V	-	1.5	4.5	μA	1
Operating Voltage	VDD		0.8	-	6.0	V	2
Output Current	IOUT _N	VDD=1.5V, VDS=0.5V	1.0	2.0	-	mA	3
	IOUT _P	VDD=4.5V, VDS=2.1V	0.5	1.5	-	mA	4
Delay Time	tPHL			0.1		mS	5
Temperature Characteristic of VDET _N	$\frac{\Delta VDET_N}{\Delta T_{op}}$	T _{op} =-30~+80°C	-	-0.24	-	mV/°C	-

Remarks) Test circuit No.

ELM9725CAA

(Top=25°C)

Parameter	Symbol	Conditions	Min.	Typ.	Max.	Units	Remarks
Detection Voltage	VDET _N		2.438	2.500	2.562	V	2
Hysteresis width	VHYS		VDET _N ×0.02	-	VDET _N ×0.08	V	2
Current Consumption	ISS	VDD=3.0V	-	1.5	4.5	μA	1
Operating Voltage	VDD		0.8	-	6.0	V	2
Output Current	IOUT _N	VDD=1.5V, VDS=0.5V	1.0	2.0	-	mA	3
	IOUT _P	VDD=4.5V, VDS=2.1V	0.5	1.5	-	mA	4
Delay Time	tPHL			0.1		mS	5
Temperature Characteristic of VDET _N	$\frac{\Delta VDET_N}{\Delta T_{op}}$	T _{op} =-30~+80°C	-	-0.25	-	mV/°C	-

Remarks) Test circuit No.

VOLTAGE DETECTOR ELM97xxxxA

ELM9727CAA

(Top=25°C)

Parameter	Symbol	Conditions	Min.	Typ.	Max.	Units	Remarks
Detection Voltage	VDET _N		2.633	2.700	2.767	V	2
Hysteresis width	VHYS		VDET _N ×0.02	-	VDET _N ×0.08	V	2
Current Consumption	ISS	VDD=4.5V	-	1.5	4.5	μA	1
Operating Voltage	VDD		0.8	-	6.0	V	2
Output Current	IOUT _N	VDD=1.5V, VDS=0.5V	1.0	2.0	-	mA	3
	IOUT _P	VDD=4.5V, VDS=2.1V	0.5	1.5	-	mA	4
Delay Time	tPHL			0.1		mS	5
Temperature Characteristic of VDET _N	$\frac{\Delta VDET_N}{\Delta T_{top}}$	Top=-30~+80°C	-	-0.27	-	mV/°C	-

Remarks) Test circuit No.

ELM9730CAA

(Top=25°C)

Parameter	Symbol	Conditions	Min.	Typ.	Max.	Units	Remarks
Detection Voltage	VDET _N		2.925	3.000	3.075	V	2
Hysteresis width	VHYS		VDET _N ×0.02	-	VDET _N ×0.08	V	2
Current Consumption	ISS	VDD=4.5V	-	1.5	4.5	μA	1
Operating Voltage	VDD		0.8	-	6.0	V	2
Output Current	IOUT _N	VDD=1.5V, VDS=0.5V	1.0	2.0	-	mA	3
	IOUT _P	VDD=4.5V, VDS=2.1V	0.5	1.5	-	mA	4
Delay Time	tPHL			0.1		mS	5
Temperature Characteristic of VDET _N	$\frac{\Delta VDET_N}{\Delta T_{top}}$	Top=-30~+80°C	-	-0.30	-	mV/°C	-

Remarks) Test circuit No.

ELM9732CAA

(Top=25°C)

Parameter	Symbol	Conditions	Min.	Typ.	Max.	Units	Remarks
Detection Voltage	VDET _N		3.120	3.200	3.280	V	2
Hysteresis width	VHYS		VDET _N ×0.02	-	VDET _N ×0.08	V	2
Current Consumption	ISS	VDD=4.5V	-	1.5	4.5	μA	1
Operating Voltage	VDD		0.8	-	6.0	V	2
Output Current	IOUT _N	VDD=1.5V, VDS=0.5V	1.0	2.0	-	mA	3
	IOUT _P	VDD=4.5V, VDS=2.1V	0.5	1.5	-	mA	4
Delay Time	tPHL			0.1		mS	5
Temperature Characteristic of VDET _N	$\frac{\Delta VDET_N}{\Delta T_{top}}$	Top=-30~+80°C	-	-0.32	-	mV/°C	-

Remarks) Test circuit No.

VOLTAGE DETECTOR ELM97xxxxA

ELM9734CAA

(Top=25°C)

Parameter	Symbol	Conditions	Min.	Typ.	Max.	Units	Remarks
Detection Voltage	VDET _N		3.315	3.400	3.485	V	2
Hysteresis width	VHYS		VDET _N ×0.02	-	VDET _N ×0.08	V	2
Current Consumption	ISS	VDD=4.5V	-	1.5	4.5	μA	1
Operating Voltage	VDD		0.8	-	6.0	V	2
Output Current	IOUT _N	VDD=1.5V, VDS=0.5V	1.0	2.0	-	mA	3
	IOUT _P	VDD=4.5V, VDS=2.1V	0.5	1.5	-	mA	4
Delay Time	tPHL			0.1		mS	5
Temperature Characteristic of VDET _N	$\frac{\Delta VDET_N}{\Delta T_{top}}$	T _{op} =-30~+80°C	-	-0.34	-	mV/°C	-

Remarks) Test circuit No.

ELM9745CAA

(Top=25°C)

Parameter	Symbol	Conditions	Min.	Typ.	Max.	Units	Remarks
Detection Voltage	VDET _N		4.388	4.500	4.612	V	2
Hysteresis width	VHYS		VDET _N ×0.02	-	VDET _N ×0.08	V	2
Current Consumption	ISS	VDD=6.0V	-	1.5	4.5	μA	1
Operating Voltage	VDD		0.8	-	6.0	V	2
Output Current	IOUT _N	VDD=1.5V, VDS=0.5V	1.0	2.0	-	mA	3
	IOUT _P	VDD=6.0V, VDS=2.1V	0.5	2.0	-	mA	4
Delay Time	tPHL			0.1		mS	5
Temperature Characteristic of VDET _N	$\frac{\Delta VDET_N}{\Delta T_{top}}$	T _{op} =-30~+80°C	-	-0.45	-	mV/°C	-

Remarks) Test circuit No.

ELM9748CAA

(Top=25°C)

Parameter	Symbol	Conditions	Min.	Typ.	Max.	Units	Remarks
Detection Voltage	VDET _N		4.680	4.800	4.920	V	2
Hysteresis width	VHYS		VDET _N ×0.02	-	VDET _N ×0.08	V	2
Current Consumption	ISS	VDD=6.0V	-	1.5	4.5	μA	1
Operating Voltage	VDD		0.8	-	6.0	V	2
Output Current	IOUT _N	VDD=1.5V, VDS=0.5V	1.0	2.0	-	mA	3
	IOUT _P	VDD=6.0V, VDS=2.1V	0.5	2.0	-	mA	4
Delay Time	tPHL			0.1		mS	5
Temperature Characteristic of VDET _N	$\frac{\Delta VDET_N}{\Delta T_{top}}$	T _{op} =-30~+80°C	-	-0.48	-	mV/°C	-

Remarks) Test circuit No.

VOLTAGE DETECTOR ELM97xxxxA

TYPICAL CHARACTERISTICS

● ELM9711NxA

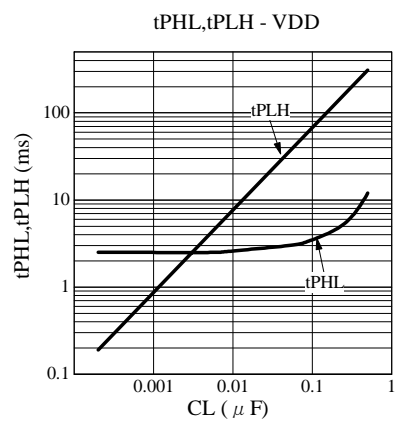
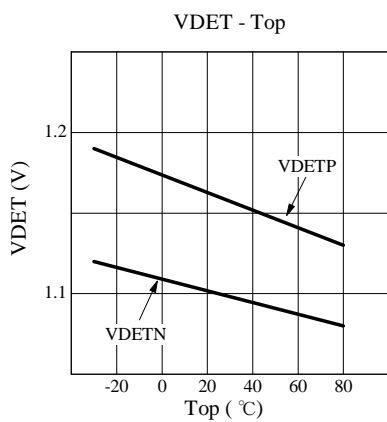
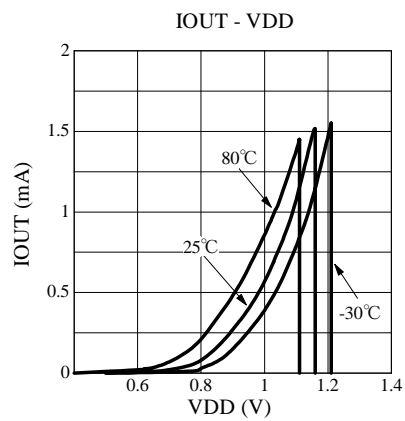
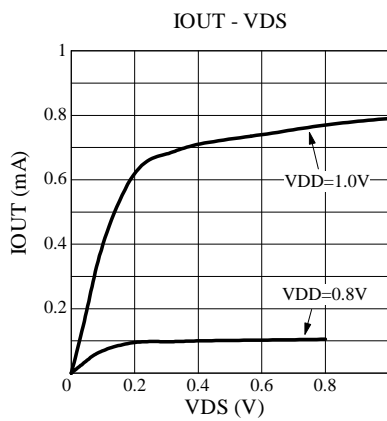
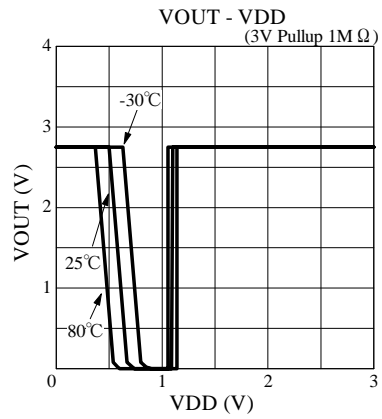
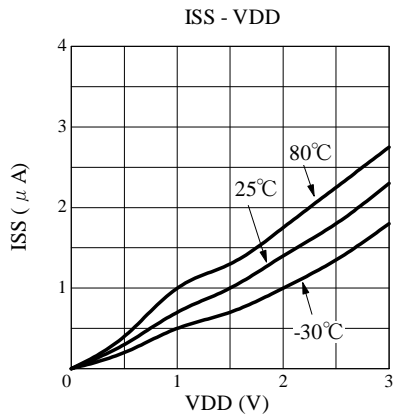

VOLTAGE DETECTOR ELM97xxxxA

■ TEST CIRCUITS

1. Current Consumption

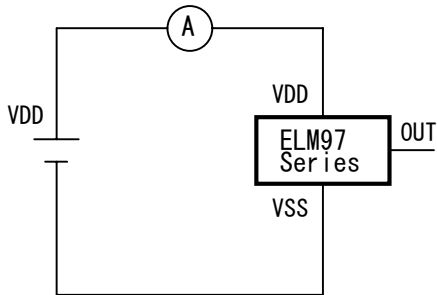

2. Detection Voltage

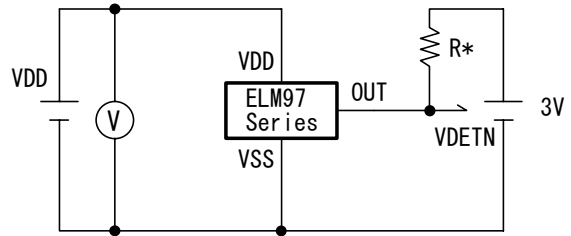

* $R=1M \Omega$

3. Output Current (N-ch)

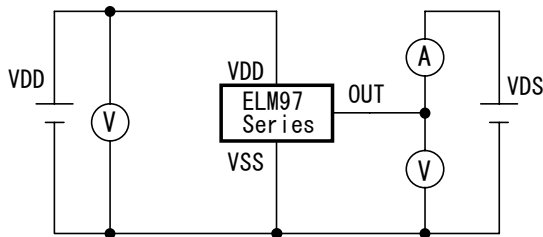

4. Output Current (P-ch)

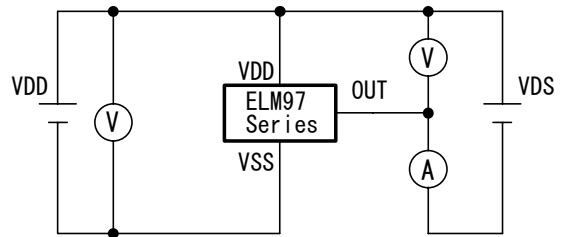

5. Delay Time

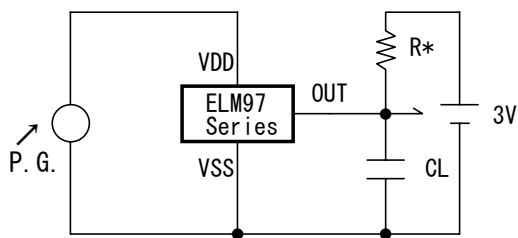

* $R=1M \Omega$
 R is unnecessary for CMOS output products.

Input Pulse

