

ELM1085DG Bipolar 3A LDO Voltage regulator

■ General description

ELM1085DG is positive and bipolar LDO three terminal voltage regulator with 3A output current capability. This series includes thermal shutdown protection and short circuit current limiter. ELM1085 series is only available in adjustable version.

■ Features

- Output voltage range (adj.) : 1.27V to 5.55V
- Line regulation : Typ.0.5%
- Load regulation : Typ.0.5%
- LDO voltage : 1.3V typical at up to 3A
- Package : TO-252

■ Application

- SCSI terminator
- Linear regulator
- Battery chargers
- Micro-controller

■ Maximum absolute ratings

Parameter	Symbol	Limit	Unit
Power supply voltage	Vcc	7	V
Power dissipation	Pd	Internally limited	W
Thermal resistance junction to case	Rθjc	5	°C/W
Thermal resistance junction to ambient	Rθja	70	°C/W
Operating junction temperature	Top	0 to +125	°C
Storage temperature	Tstg	-40 to +150	°C
Lead temperature(soldering 10s.)	Tlead	260	°C

■ Selection guide

ELM1085DG-S

Symbol		
a	Package	D: TO-252
b	Product version	G
c	Taping direction	S: Refer to PKG file

ELM1085 D G - S
 ↑ ↑ ↑
 a b c

* Taping direction is one way.

■ Pin configuration

TO-252(TOP VIEW)

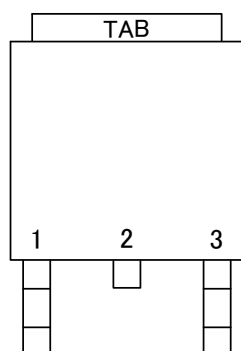

Pin No.	Pin name
1	ADJ/GND
2/TAB	VOUT
3	VIN

ELM1085DG Bipolar 3A LDO Voltage regulator

■ Typical application

$$V_{out} = V_{ref} (1 + R2/R1) + I_{adj} \times R2$$

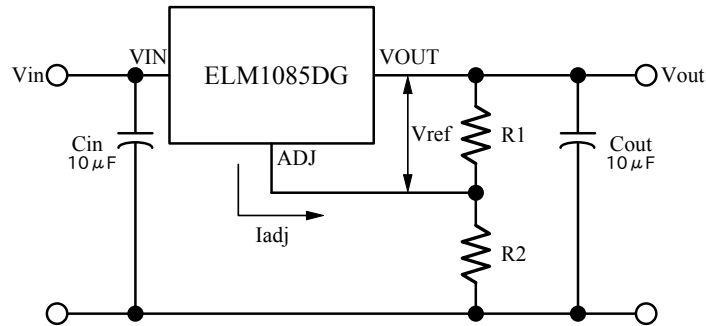

- * Cin needed if device is far from filter capacitors.
- * Cout required for stability.
- * We recommend to use Min. 10µF tantalum condenser.

■ Electrical characteristics

Top=25°C

Parameter	Symbol	Condition	Min.	Typ.	Max.	Unit
Reference voltage	Vref	Iout=10mA, Vin=5V	1.23	1.25	1.27	V
Line regulation	$\Delta V_{out}/\Delta V_{in}$	Iout=10mA, Vin=(Vout+1.5V) to 7V		0.5	2.0	%
Load regulation	$\Delta V_{out}/\Delta I_{out}$	Iout=10mA to 3A, Vin-Vout=3V		0.5	2.5	%
Dropout voltage	Vdif	Iout=3A, $\Delta V_{ref}=1\%$		1.30	1.45	V
Current limit	Ilim	Vin-Vout=2V	4	5		A
Min.load current	I _l (min)	1.5V ≤ (Vin-Vout) ≤ 5.75V		10		mA
Adjust Pin current	Iadj			55	100	µA
RMS output noise	Vn			Vout × 0.003%		mV
Ripple rejection ratio	RR	f=120Hz, Vin=5V, Iout=3A, Cout=22µF	60	72		dB

■ Marking

TO-252

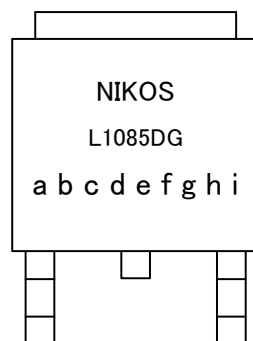

- L : LDO
- 1085 : Product No.code
- D : PKG type (TO-252)
- G : Pb-Free package mark
- a to i : Production code

ELM1085DG Bipolar 3A LDO Voltage regulator

■ Typical characteristics

Dropout Voltage vs. Output Current

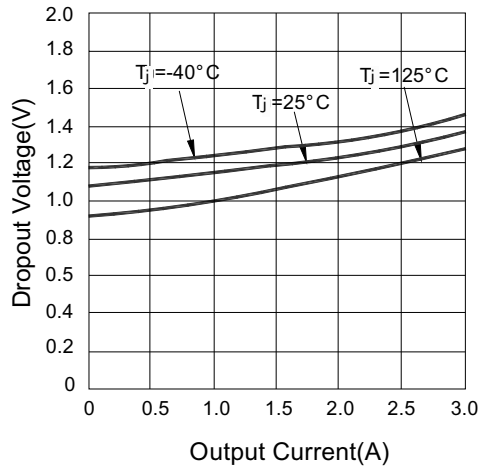

Short-Circuit Current vs. Temperature

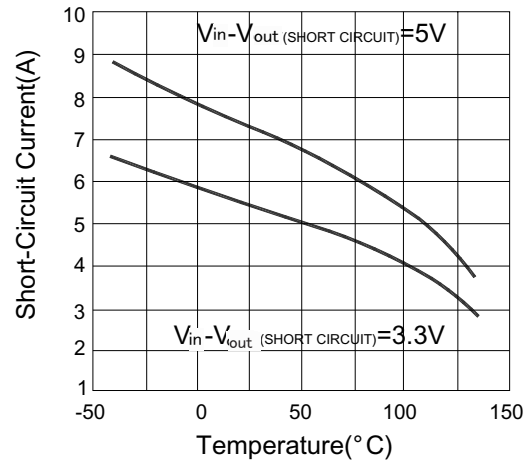

Percent Change in Output Voltage vs. Temperature

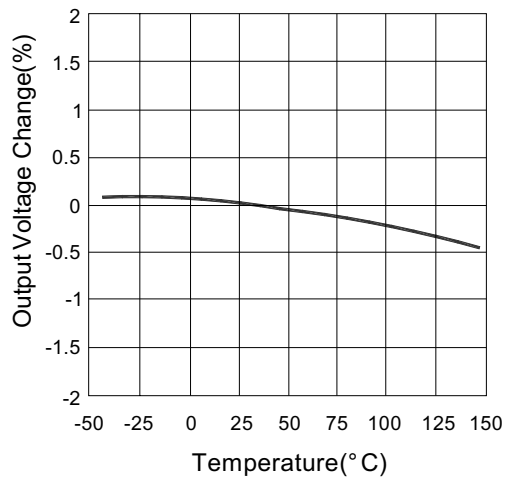

Adjust Pin Current vs. Temperature

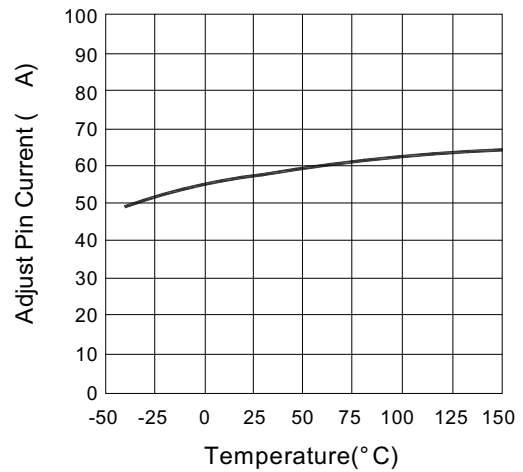

Ripple Rejection vs. Frequency

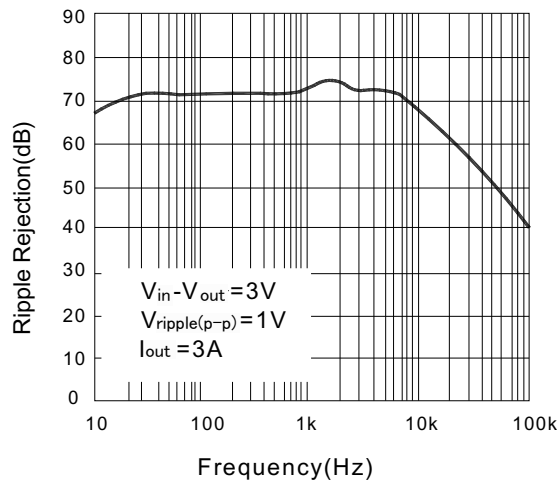

Maximum Power Dissipation*

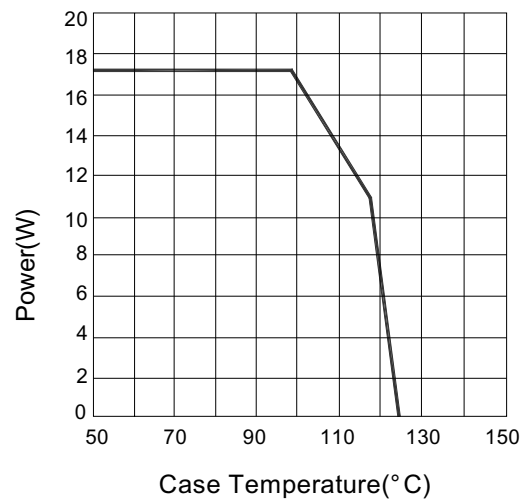

*as Limited by Maximum Junction Temperature