

EuroMag Series PCB Mount Terminal Blocks

EM2507 Series Euro-Mag Terminal Blocks 7.50 Centers; Modular

SPECIFICATIONS

Rating: 16A, 300V

Center Spacing: 0.295" (7.50mm)

Wire Range: #14-22 AWG

Housing Material: UL rated 94V0 Thermoplastic

Contact Material: Brass Tin-Plated

Cage Clamp: Brass, Nickel-Plated

Screw Size: M2.6 Nickel-Plated Steel

Operating Temperature: 105°C (221°F) max., -40°C (-40°F) min.

Torque Rating: 5.0 lb-in.

Recommended PCB Hole Diameters: 0.055" (1.40mm)

Construction: Modular design features dovetails for interlocking to achieve longer lengths

Agency Information:  File E62622; CE Certified



EM250705

Dimensions - mm (in)

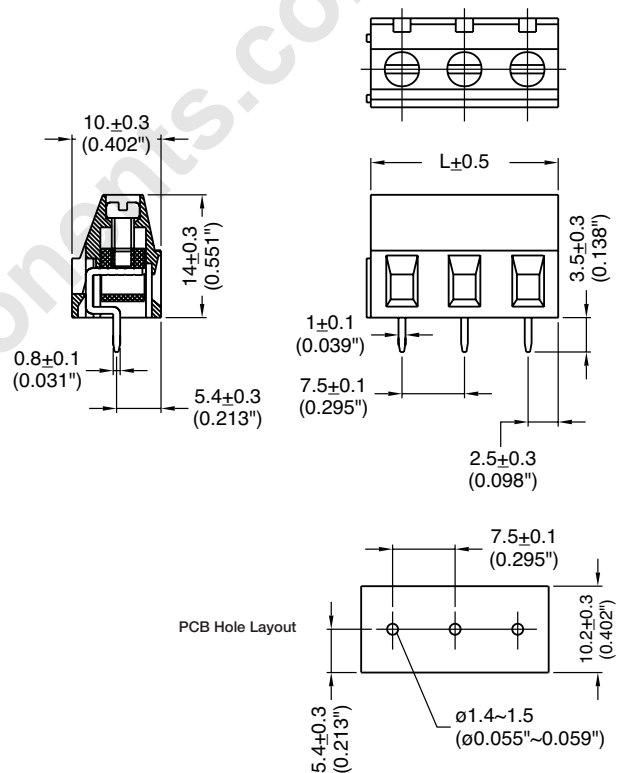

Poles	L (mm)	Poles	L (mm)
2	15.0	14	105.0
3	22.5	15	112.5
4	33.0	16	120.0
5	37.5	17	127.5
6	45.0	18	133.0
7	52.5	19	142.5
8	60.0	20	150.0
9	67.5	21	157.5
10	75.0	22	165.0
11	82.5	23	172.5
12	90.0	24	180.0
13	97.5		

To convert to inches, divide by 25.4

Part Numbering System

Series

of Poles

EM2507

02 to 24