

1.8A Sink/Source Bus Termination Regulator

General Description

The EM5045 performs ultra low drop voltage and fast response linear regulator specifically designed to provide termination voltage for DDR memory system. This device works with dual supplies, a control input for the control circuitry and a power input for providing current to output and designed to source/sink up to 1.8A output current. Output voltage is regulated to track the reference voltage within 20mV variation.

The other features include soft start, current limit protection, Power-On-Reset function, and over temperature protection. The EM5045 is available in PSOP8 package.

Ordering Information

Part Number	Package	Remark
EM5045GE	PSOP-8 Lead-Free	

Features

- Termination Voltage for DDRII/DDRIII Memory System
- Stable with Output Ceramic Capacitor
- Excellent Line Regulation
- Excellent Load Regulation
- Output Voltage is Adjustable
- 1.8A Output Source/Sink Current
- Bidirectional Current Limit Protection
- Over Temperature Protection
- RoHS Compliant and 100% Lead (Pb)-Free

Applications



- DDRII/DDRIII Memory Systems
- Notebook & Netbook
- Graphics Card & MB
- Low Voltage Logic Supplies
- SMPS Post Regulators
- Set Top Boxes , Digital TVS , Printers
- Active Termination Buses

Pin Configuration

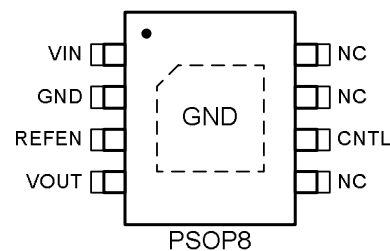

Typical Application Circuit

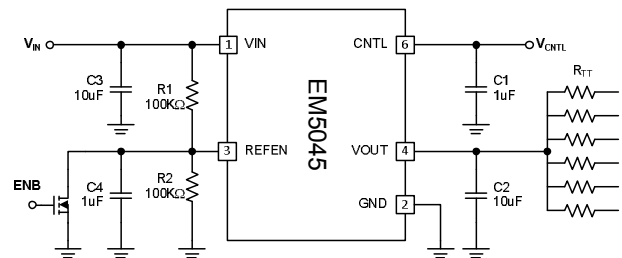

Pin Assignment

Pin Name	Pin No.	Pin Function
VIN	1	Input Voltage. This is the drain input to the power device that supplies current to the output pin. Minimum 10uF low ESR ceramic capacitor is recommended at this pin.
GND	2	Ground.
REFEN	3	Reference Voltage Input. This pin is the non-inverting input of the error amplifier. The output voltage is regulated to track the reference voltage input. Pulling the pin below 0.15V turns the regulator off.
VOUT	4	Output Voltage. VOUT is power output pin. Minimum 10uF low ESR ceramic capacitor is required at this pin for stabilizing VOUT voltage.
NC	5	No Connection.
CNTL	6	Supply Input for Control Circuit. CNTL provides supply voltage to the control circuitry and driver for the pass transistor. The driving capability of output current is proportioned to the V_{CNTL} .
NC	7	No Connection.
NC	8	No Connection.

Function Block Diagram

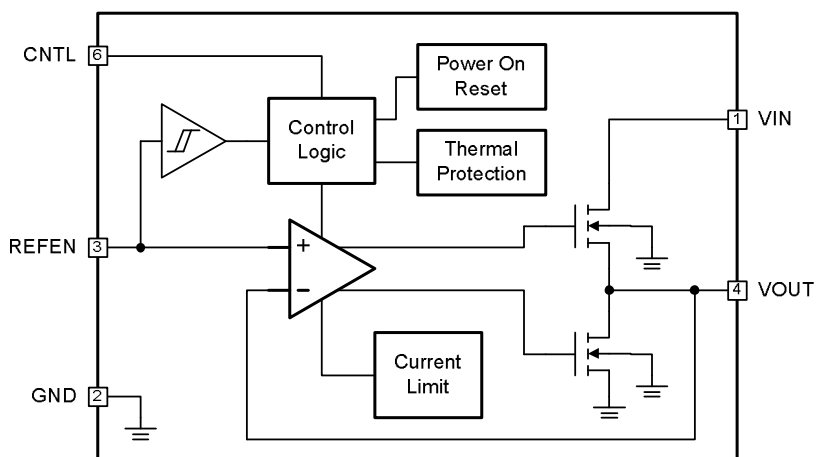

Absolute Maximum Ratings (Note1)

- V_{IN} ----- -0.3V to +6.0V
- V_{CNTL} ----- -0.3V to +6.0V
- Other Pins----- -0.3V to ($V_{CNTL}+0.3V$)
- Power Dissipation, $P_D @ T_A = 25^\circ C$, PSOP8 ----- 1.33W
- Package Thermal Resistance, θ_{JA} , PSOP8 (Note 2)----- 75°C/W
- Junction Temperature----- 150°C
- Lead Temperature (Soldering, 10 sec.)----- 260°C
- Storage Temperature ----- -65°C to 150°C
- ESD susceptibility (Note3)
 - HBM (Human Body Mode)----- 2KV
 - MM (Machine Mode)----- 200V

Recommended Operating Conditions (Note4)

- Control Voltage, V_{CNTL} ----- +4.5V to +5.5V
- Supply Input Voltage, V_{IN} ----- +1V to V_{CNTL}
- Junction Temperature ----- -40°C to 125°C
- Ambient Temperature ----- -40°C to 85°C

Electrical Characteristics

$V_{CNTL} = 5V$, $V_{IN} = 1.8V$, $V_{REFEN} = 0.9V$, $T_A = 25^\circ C$, unless otherwise specified

Parameter	Symbol	Test Conditions	Min	Typ	Max	Units
Supply Input Section						
Control Input Voltage	V_{CNTL}		4.5	-	5.5	V
POR Threshold	V_{PORTH}	V_{CNTL} rising	-	3.6	-	V
POR Hysteresis	V_{PORHYS}		-	0.2	-	V
CNTL Operation Current	I_{CNTL}	$I_{OUT}=0A$	-	0.7	2.5	mA
Shutdown Current	I_{SD}	$V_{REFEN}=0V$	-	50	90	uA
Output Voltage						
Output Offset Voltage	V_{OS}	$I_{OUT}=0A$	-20	-	20	mV
Load Regulation	ΔV_{LOAD}	$I_{OUT} = \pm 1.8A$	-20	-	20	mV
REFEN Shutdown						
Enable High Level	V_{EN}		0.4	-	-	V
Disable Low Level	V_{SD}		-	-	0.15	V
Protection						
OCP Threshold Level	I_{OCP}	Source / Sink	1.8	3.0	4.2	A
Output Short Circuit Current	I_{SC}	Source / Sink	-	1.5	-	A
Thermal Shutdown Temperature	T_{SD}	$V_{EN}=V_{IN}$, $I_{OUT}=0A$	-	160	-	°C
Thermal Shutdown Hysteresis	T_{SDHYS}	$V_{EN}=V_{IN}$, $I_{OUT}=0A$	-	30	-	°C

Note 1. Stresses listed as the above “Absolute Maximum Ratings” may cause permanent damage to the device. These are for stress ratings. Functional operation of the device at these or any other conditions beyond those indicated in the operational sections of the specifications is not implied. Exposure to absolute maximum rating conditions for extended periods may remain possibility to affect device reliability.

Note 2. θ_{JA} is measured in the natural convection at $T_A=25^\circ C$ on a 4-layers high effective thermal conductivity test board with minimum copper area of JEDEC 51-7 thermal measurement standard.

Note 3. Devices are ESD sensitive. Handling precaution is recommended.

Note 4. The device is not guaranteed to function outside its operating conditions.

Typical Operating Characteristics

$V_{CNTL}=5V$; $C_{IN}=C_{OUT}=10\mu F$

Power On from V_{IN}

$V_{IN}=1.8V$; $V_{OUT}=0.9V$; Load= 5Ω

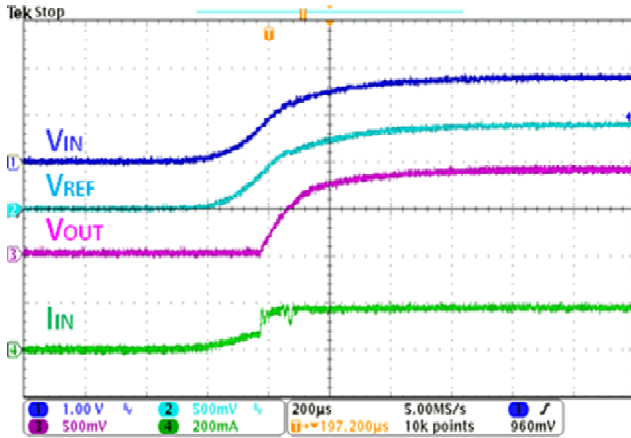

Power Off from V_{IN}

$V_{IN}=1.8V$; $V_{OUT}=0.9V$; Load= 5Ω

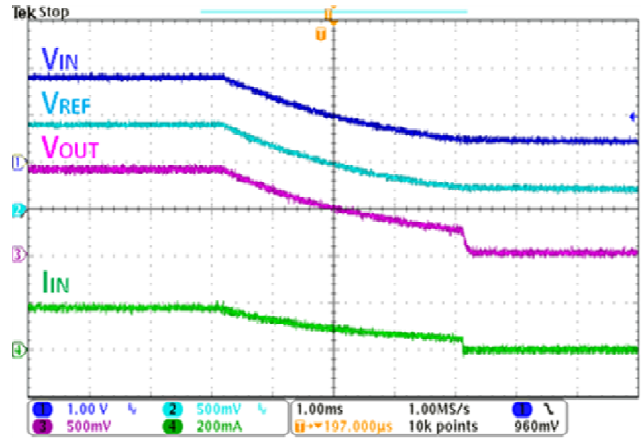

Power On from V_{CNTL}

$V_{IN}=1.8V$; $V_{OUT}=0.9V$; Load= 5Ω

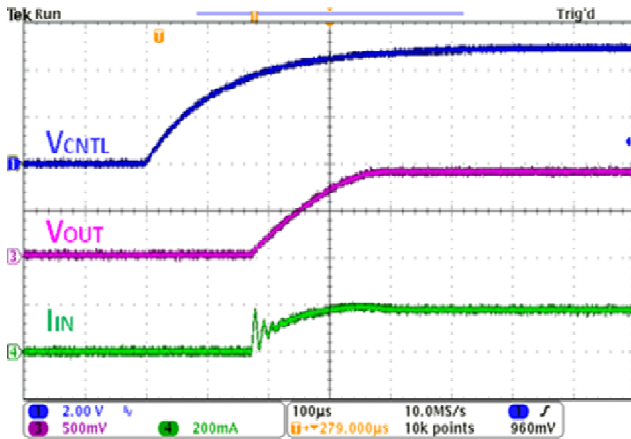

Power Off from V_{CNTL}

$V_{IN}=1.8V$; $V_{OUT}=0.9V$; Load= 5Ω

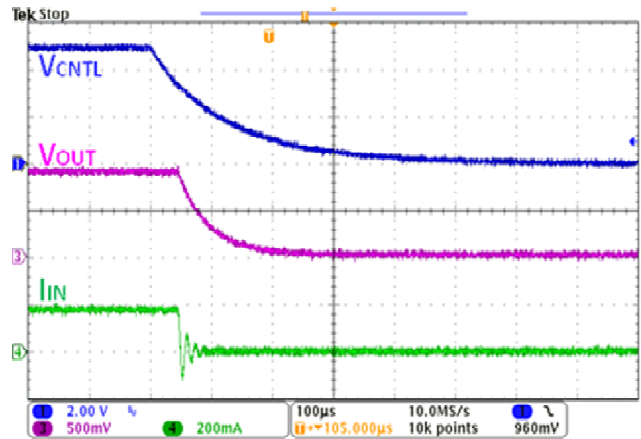

Load Transient Response

$V_{IN}=1.8V$; $V_{OUT}=0.9V$

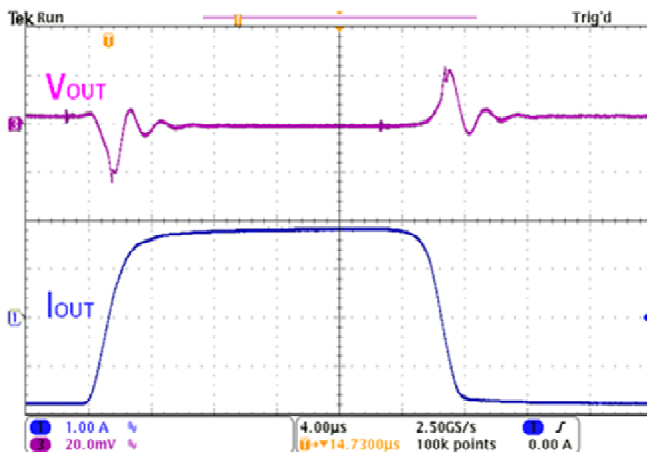

Load Transient Response

$V_{IN}=1.2V$; $V_{OUT}=0.6V$

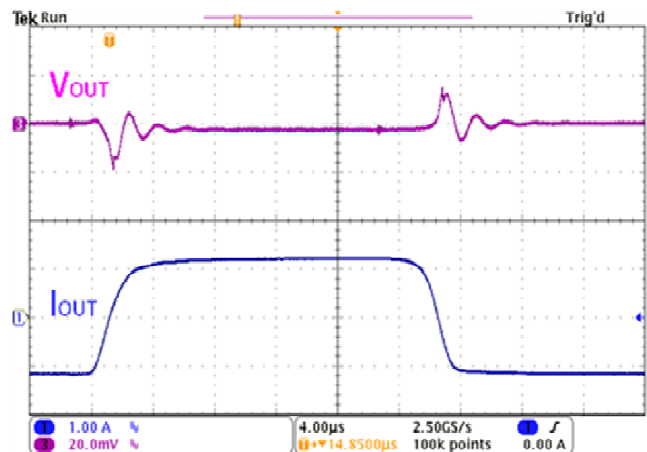

OCP/Source

$V_{IN}=1.8V$; $V_{OUT}=0.9V$

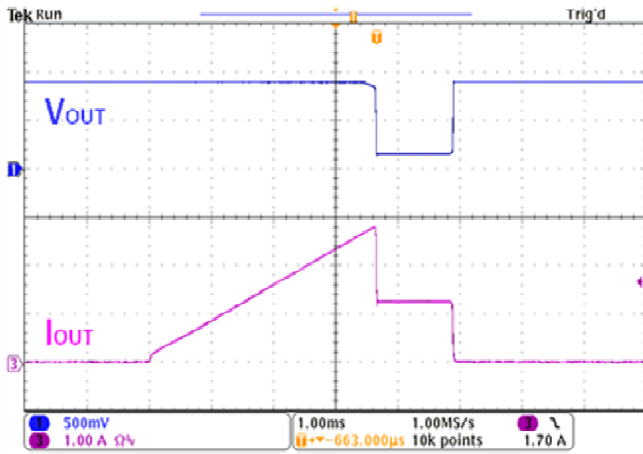

OCP/Sink

$V_{IN}=1.8V$; $V_{OUT}=0.9V$

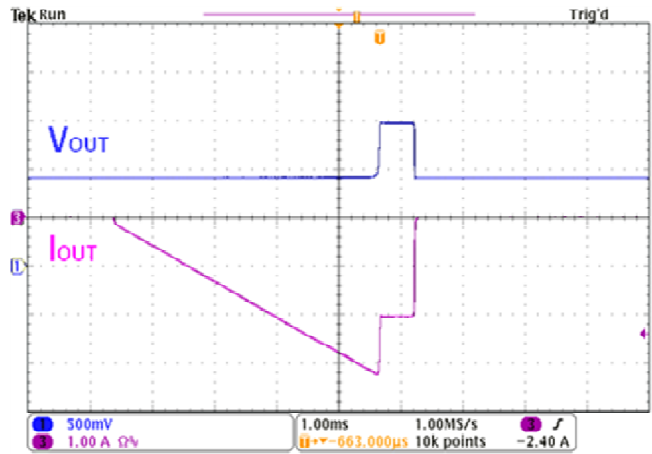

$V_{OUT}@0.9V$ vs. Temperature

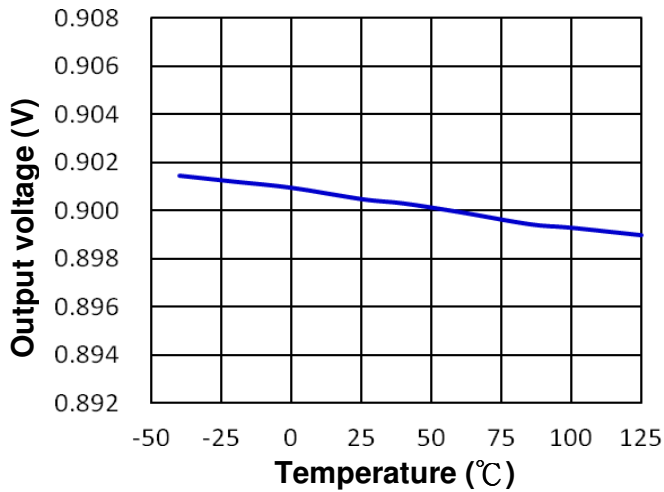

$V_{OUT}@0.6V$ vs. Temperature

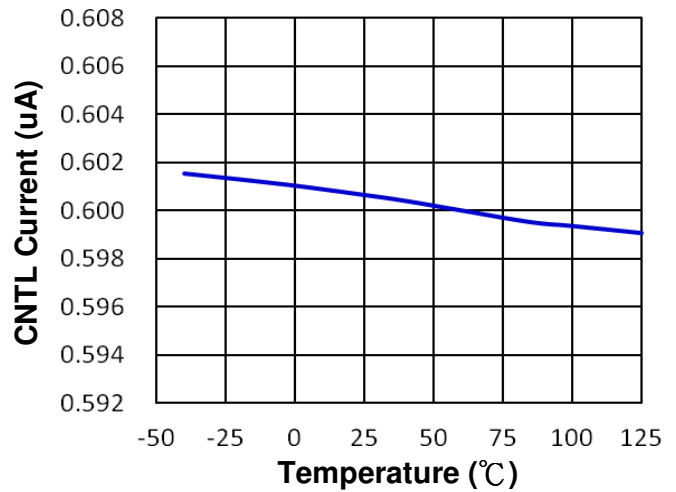

V_{REFEN} Threshold vs. Temperature

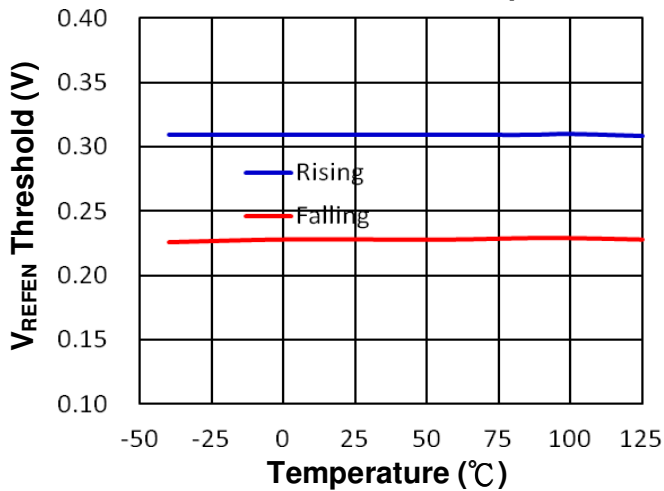

Quiescent Current vs. Temperature

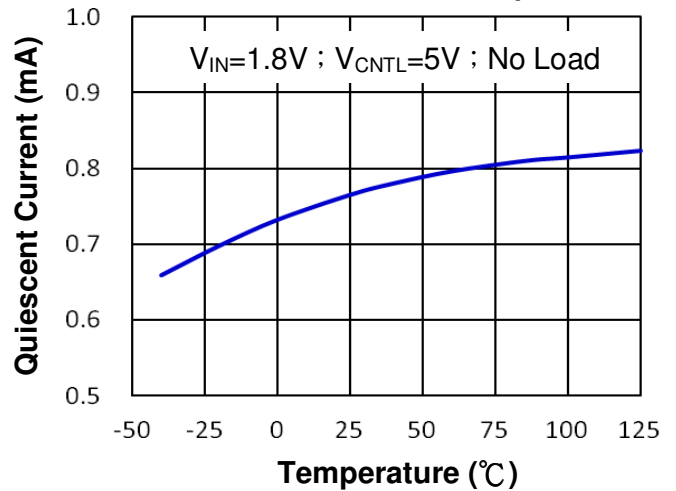



Source current limit vs. Temperature

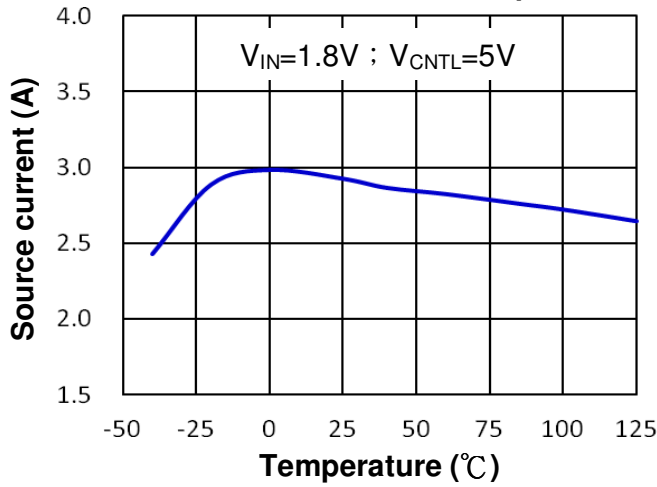

Source short circuit current vs. Temperature

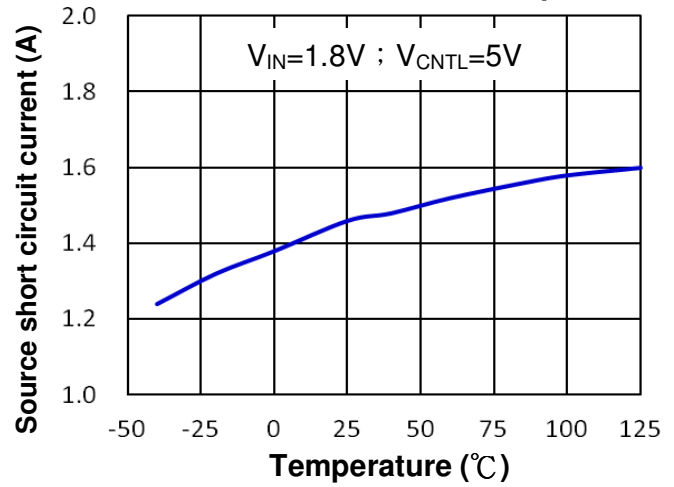

Sink current limit vs. Temperature

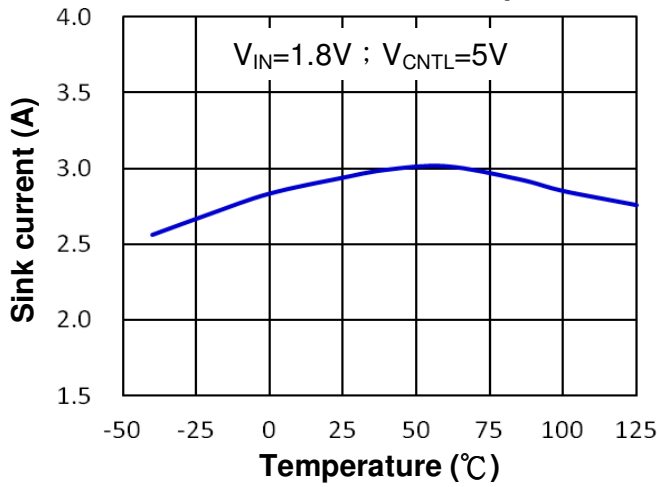

Sink short circuit current vs. Temperature

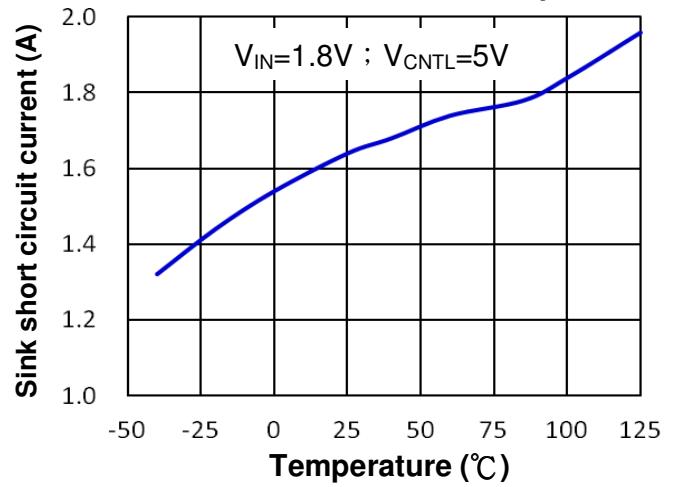

Shutdown current vs. Temperature

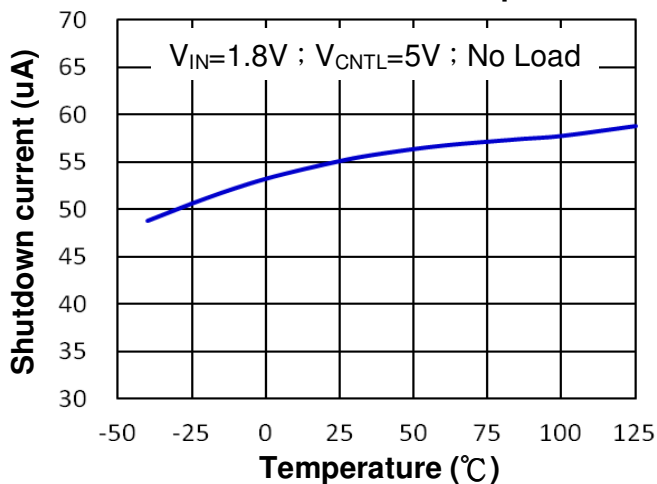

Functional Description

Reference Input

The output voltage is regulated to track the reference voltage at REFEN pin. The reference voltage can be obtained from power input by external voltage divider or from an independent voltage reference. Refer to typical application circuit, output voltage is calculated by the following equation,

$$V_{OUT} = V_{IN} \times R2 / (R1 + R2)$$

Shutdown Control Function

EM5045 is enabled if the voltage of the REFEN pin is greater than 0.4V. If the voltage of the REFEN pin is less than 0.15V, the IC will be disabled.

POR – Power ON Reset

To let EM5045 start to operation, CNTL voltage must be higher than its POR voltage even when REFEN voltage is pulled higher than enable high voltage. Typical POR voltage is 3.6V.

Over Current Limit Function

EM5045 features over current limiting function as well as output short circuit current fold back function. Typically, before the thermal protection is triggered, EM5045 can limit its output current to 3.0A. When output voltage is decreased, the limiting current level also decreases. When VOUT is short to GND, or VOUT voltage is zero, the output current level is limited to 1.5A, typically.

Input and Output Capacitor Selection

For CNTL pin, a 1uF ceramic capacitor is enough for bypass the supply of CNTL to GND. For VIN pin, 10uF or larger ceramic capacitor is required to provide bypass path in transient current demand. VOUT pin is also recommended to have 10uF or larger ceramic capacitor to be stable and reduce the VOUT voltage dip when fast loading transient is happened.

Power Dissipation

The maximum power depends on some conditions, including of thermal impedance, PCB layout, airflow, and so on. The maximum power dissipation can be calculated by the formula as below

$$P_{D(max)} = (T_{J(max)} - T_A) / \theta_{JA}$$

$T_{J(max)}$ is the maximum, junction temperature; θ_{JA} is the thermal impedance from junction to ambient. The thermal impedance θ_{JA} of exposed SOP-8 is package design and PCB design dependent. The thermal impedance can be reduced by increasing the copper area under the exposed pad of the SOP-8 package. So, to let the copper area as large as possible is helpful for the thermal performance of the exposed SOP-8 package.

For recommended specification of EM5045, the maximum junction temperature is 125 degree C. The θ_{JA} of exposed SOP-8 is 75°C/W on the standard JEDEC 51-7(4 layers, 2S2P, copper 2 oz) thermal test board. The maximum power dissipation (at 25°C ambient, on the minimum exposed pad layout) can be calculated as below:

$$P_{D(max \text{ at } 25^\circ\text{C})} = (125^\circ\text{C} - 25^\circ\text{C}) / (75^\circ\text{C/W}) = 1.33\text{W}$$

Marking Information

Device Name: EM5045GE for PSOP-8

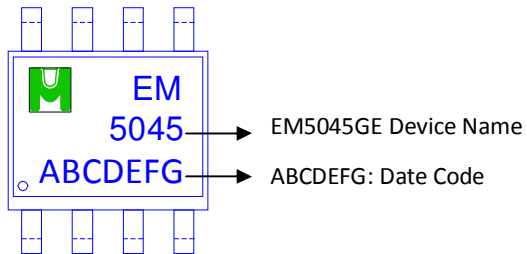

Outline Drawing

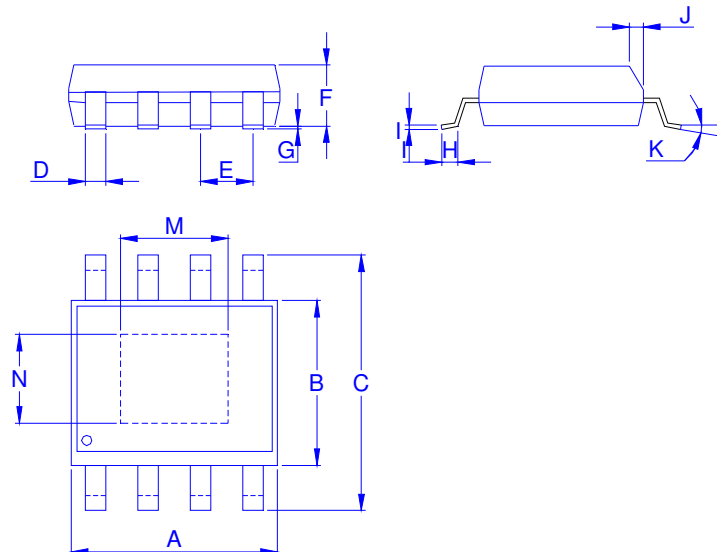

Dimension in mm

Dimension	A	B	C	D	E	F	G	H	I	J	K	M	N
Min.	4.70	3.70	5.80	0.33		1.20	0.08	0.40	0.19	0.25	0°	1.94	1.94
Typ.					1.27								
Max.	5.10	4.10	6.20	0.51		1.62	0.28	0.83	0.26	0.50	8°	2.49	2.49