



Ultra-low Resistance with Quick Rising Time Load Switch

General Description

The EM5201B is a small, ultra-low RON, single channel load switch with controlled turn on. The device contains an N-channel MOSFET that can operate over an input voltage range of 0.8V to 5V and can support a maximum continuous current of 4.5A.

The combination of ultra-low RON and high current capability of the device makes it ideal for driving processor rails with very tight voltage dropout tolerances.

The EM5201B is available in a small, space-saving SOT23-6 with integrated thermal pad allowing for high power dissipation.

Ordering Information

Part Number	Package	Remark
EM5201BJ-45	SOT23-6	20m ohm

Features

- VBIAS Voltage Range : 3V to 5.5V
- VIN Voltage Range : 0.8V to 5.5V
- Low Ron Internal NMOS: Ron=20m ohm at Vin=1.05V(VBIAS=3.3V to 5.5V)
- 4.5A Maximum Continuous Switch Current
- Low Quiescent Current (20uA at VBIAS=5V)
- Low Shutdown Current (1uA at VBIAS=5V)
- Quick Output Discharge
- SOT23-6 Package

Applications

- Notebook & Netbook & MB
- Desktops
- Tablet PC

Pin Configuration

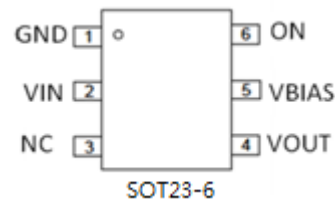

Typical Application Circuit

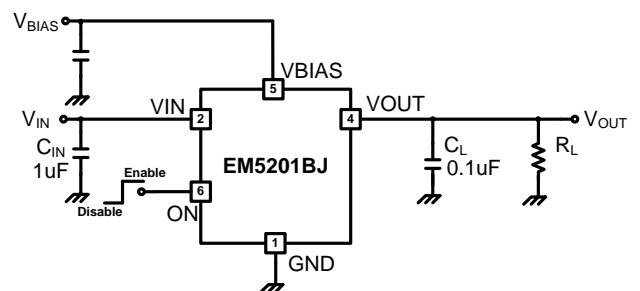

* $C_{IN} > 10 \times C_L$ is recommended.

Pin Assignment

Pin Name	Pin No.	Pin Function
VIN	2	Switch input. Place ceramic bypass capacitor(s) between this terminal and GND.
VBIAS	5	Bias voltage. Power supply to the device.
ON	6	Chip Enable Input
GND	1	GND
VOUT	4	Output Voltage.

Function Block Diagram

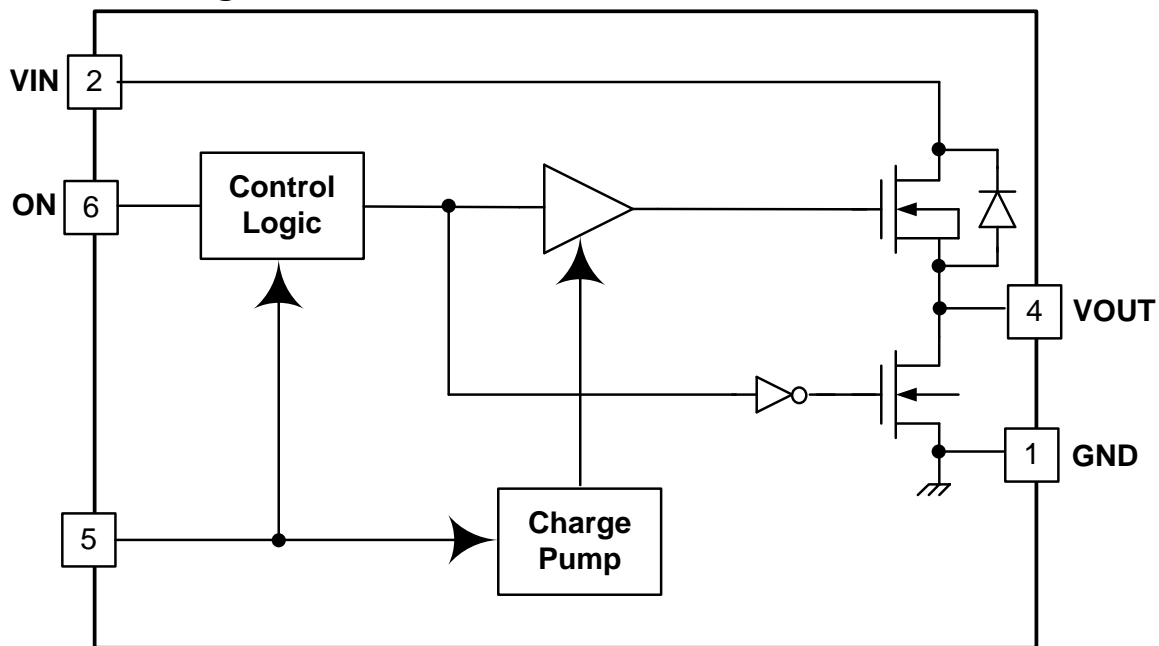

Absolute Maximum Ratings (Note1)

- V_{IN} ----- 0.8V to 5.5 V
- Other Pins ----- 5.5V
- Power Dissipation, PD @ $T_A = 25^{\circ}C$, SOT23-6 ----- 0.43 W
- Package Thermal Resistance, θ_{JA} , SOT23-6(Note 2) ----- $230^{\circ}C/W$
- Junction Temperature ----- $150^{\circ}C$
- Lead Temperature (Soldering, 10 sec.) ----- $260^{\circ}C$
- Storage Temperature ----- $-65^{\circ}C$ to $150^{\circ}C$
- ESD susceptibility (Note3)
 - HBM (Human Body Mode) ----- 2KV
 - MM (Machine Mode) ----- 200V
 - CDM (Charge Device Mode) ----- 1KV

Recommended Operating Conditions (Note4)

- Supply Input Voltage, V_{IN} ----- 0.8V to VBIAS
- Bias Input Voltage, VBIAS ----- 3V to 5.5V
- Junction Temperature ----- $-40^{\circ}C$ to $125^{\circ}C$
- Ambient Temperature ----- $-40^{\circ}C$ to $85^{\circ}C$

Electrical Characteristics

$V_{BIAS} = V_{ON} = 3V$ to 5.5V, $V_{IN} = V_{BIAS} - 2V$, $T_A = 25^\circ C$, unless otherwise specified

Parameter	Symbol	Test Conditions	Min	Typ	Max	Units
Power Supplies and Currents Section						
V_{BIAS} Supply Voltage	V_{BIAS}		3		5.5	V
V_{BIAS} quiescent current	I_{Q-BIAS}	$I_{OUT} = 0, V_{IN} = 3V$		20	40	μA
V_{BIAS} shutdown current	$I_{SD-BIAS}$	$V_{ON} = 0V ; V_{OUT} = 0V$		1	10	μA
V_{IN} shutdown current	I_{SD-IN}	$V_{ON} = 0V ; V_{OUT} = 0V$		1	10	μA
High-level input voltage	V_{ON-H}		1.2			V
Low-level input voltage	V_{ON-L}				0.6	V
ON pin leakage current	I_{ON}	$V_{ON} = 5.5V$			1	μA
Resistance Section						
ON-state Resistance	R_{ON}	$I_O = 1A,$ $V_{BIAS} = 3V$ to 5.5V $V_{IN} = V_{BIAS}, EM5201BJ-45$		20	35	$m\Omega$
Output Pull-down Resistance	R_{PD}	$V_{IN} = 5.0V, V_{ON} = 0V, I_{OUT} = 5mA$		250	300	Ω

- Note 1.** Stresses listed as the above “Absolute Maximum Ratings” may cause permanent damage to the device. These are for stress ratings. Functional operation of the device at these or any other conditions beyond those indicated in the operational sections of the specifications is not implied. Exposure to absolute maximum rating conditions for extended periods may remain possibility to affect device reliability.
- Note 2.** θ_{JA} is measured in the natural convection at $T_A = 25^\circ C$ on a low effective thermal conductivity test board (Single layout, 1S) of JEDEC 51-3 thermal measurement standard.
- Note 3.** Devices are ESD sensitive. Handling precaution is recommended.
- Note 4.** The device is not guaranteed to function outside its operating conditions.
- Note 5.** EMC will review datasheet by quarter, and update new version.

Switching Timing Diagrams

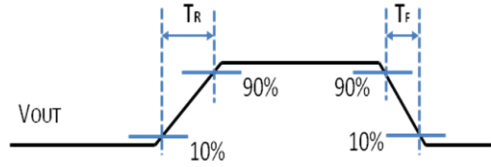
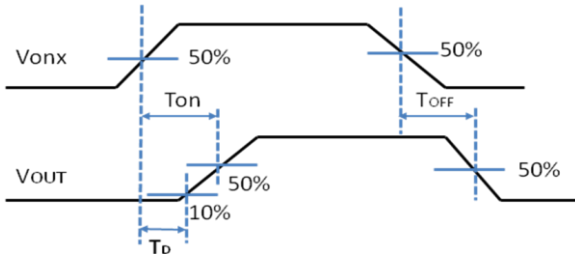

Switching characteristics

Parameter	Symbol	Test Conditions	Min	Typ	Max	Units
$V_{IN}=2.5V$; $V_{ON}=V_{BIAS}=5V$; $T_A=25^{\circ}C$						
Turn-on time	T_D+T_R	$R_L=10\Omega$; $C_L=0.1\mu F$	5	10	20	μS
Turn-off time	T_{OFF}		1	3.5	5	μS
Vout falling time	T_F		1	2	5	μS
$V_{IN}=1.05V$; $V_{ON}=V_{BIAS}=5V$; $T_A=25^{\circ}C$						
Turn-on time	T_D+T_R	$R_L=10\Omega$; $C_L=0.1\mu F$	3	7	12	μS
Turn-off time	T_{OFF}		1	3.5	5	μS
Vout falling time	T_F		1	2	5	μS
$V_{IN}=1.05V$; $V_{ON}=V_{BIAS}=3.3V$; $T_A=25^{\circ}C$						
Turn-on time	T_D+T_R	$R_L=10\Omega$; $C_L=0.1\mu F$	10	20	30	μS
Turn-off time	T_{OFF}		1	3.5	5	μS
Vout falling time	T_F		1	2	5	μS

Typical Operating Characteristics

CIN=1u, Co=0.1u, CL=10Ω, VIN=VBIAS-2V.

Von to Vo Ready, VIN=1.05V, VBIAS=5V.

CH1:VON, CH2:VIN, CH3:Vo

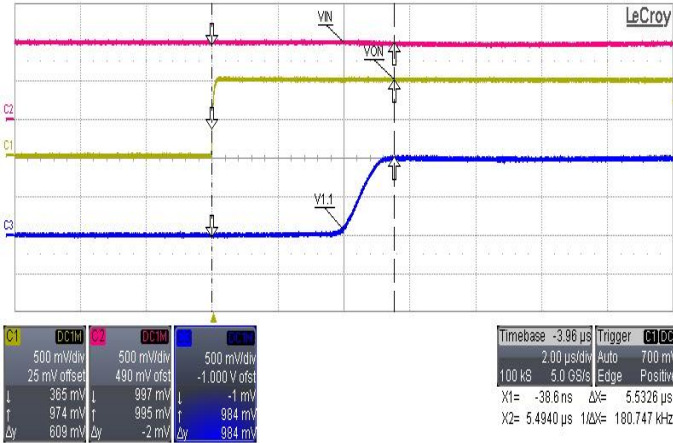

Von to Vo TD, VIN=1.05V, VBIAS=5V

CH1:VON, CH2:VIN, CH3:Vo

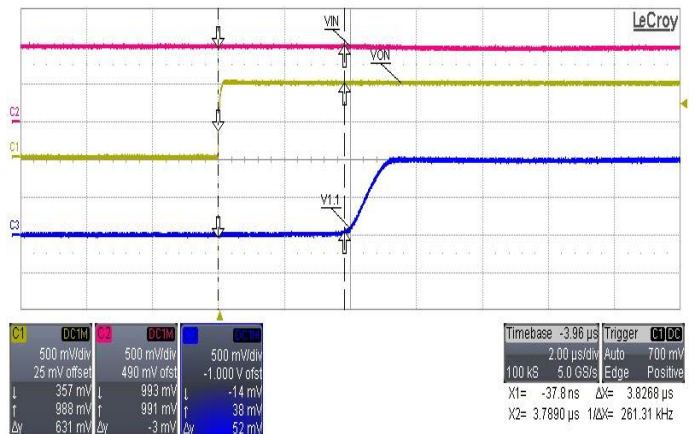

Rising time TR, VIN=1.05V, VBIAS=5V.

CH1:VON, CH2:VIN, CH3:Vo

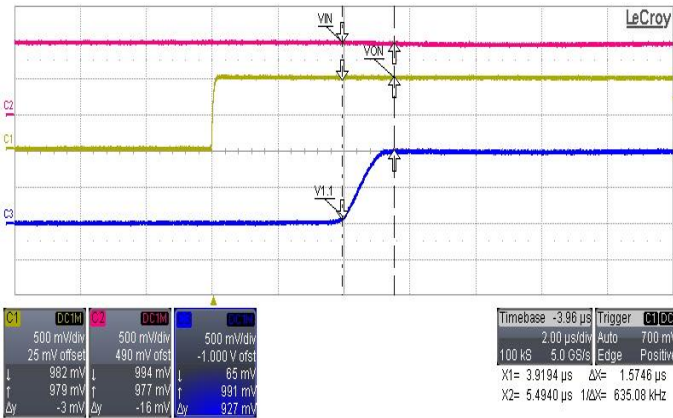

Turn off TOFF from VON, VIN=1.05V, VBIAS=5V

CH1:VIN, CH2:VON, CH3:Vo

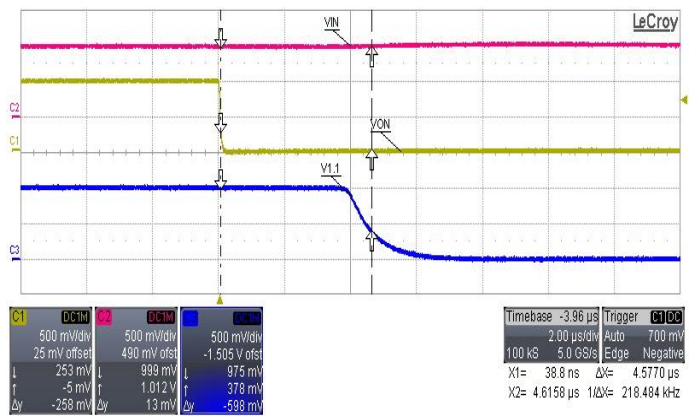

Turn off TF from VON, VIN=1.05V, VBIAS=5V

CH1:VIN, CH2:VON, CH3:Vo

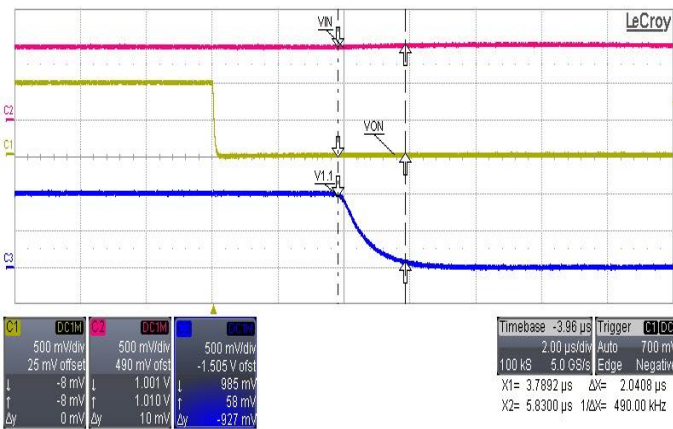

Von to Vo Ready, VIN=1.05V, VBIAS=3.3V.

CH1:VON, CH2:VIN, CH3:Vo

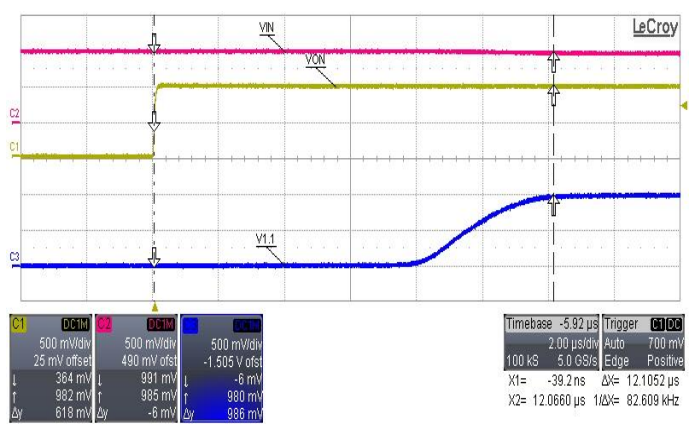

Von to Vo TD, VIN=1.05V, VBIAS=3.3V
CH1:VON, CH2:VIN, CH3:Vo

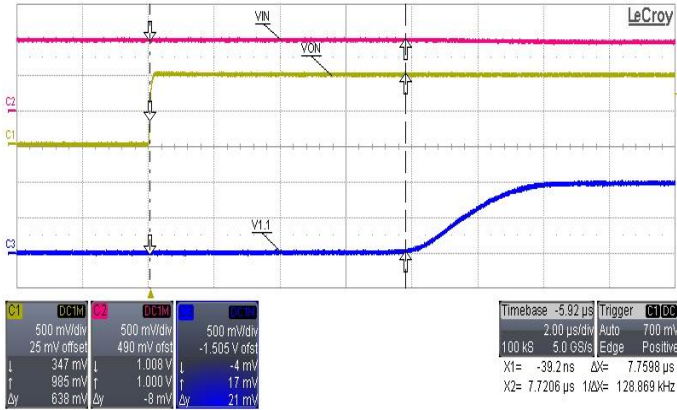

Rising time TR, VIN=1.05V, VBIAS=3.3V
CH1:VON, CH2:VIN, CH3:Vo

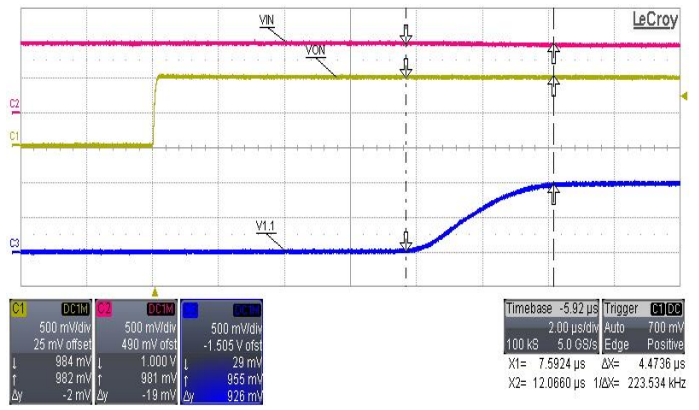

Turn off TOFF from VON, VIN=1.05V, VBIAS=3.3V
CH1:VIN, CH2:VON, CH3:Vo

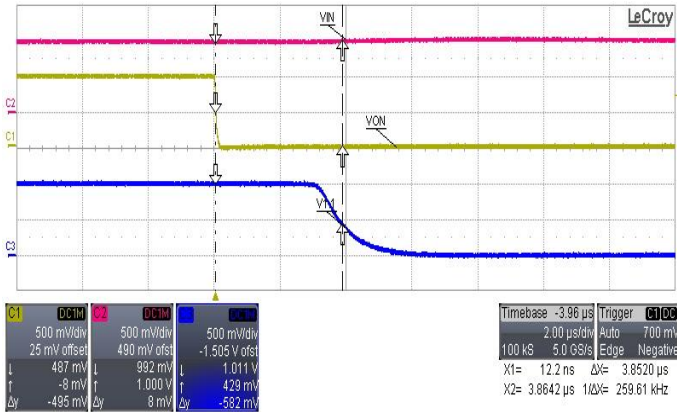

Turn off TF from VON, VIN=1.05V, VBIAS=3.3V
CH1:VIN, CH2:VON, CH3:Vo

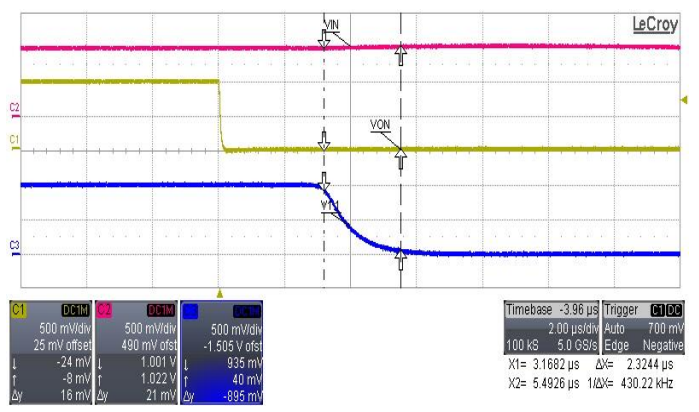

Von to Vo Ready, VIN=1.35V, VBIAS=5V
CH1:VON, CH2:VIN, CH3:Vo

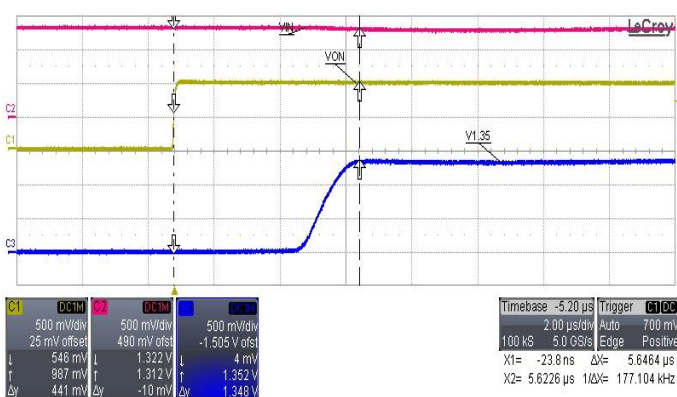

Von to Vo TD, VIN=1.35V, VBIAS=5V
CH1:VON, CH2:VIN, CH3:Vo

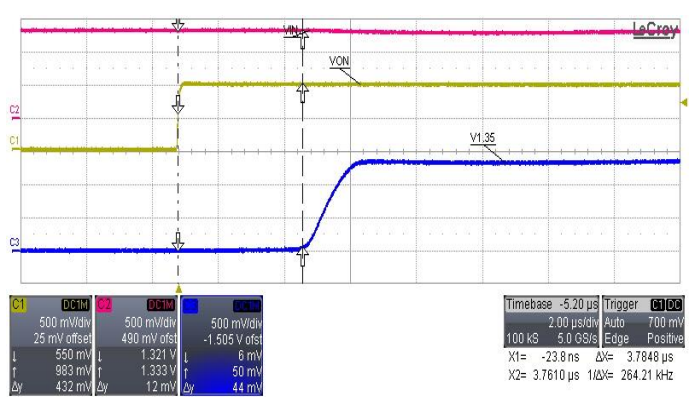

Rising time TR, VIN=1.35V, VBIAS=5V
CH1:VON, CH2:VIN, CH3:VO

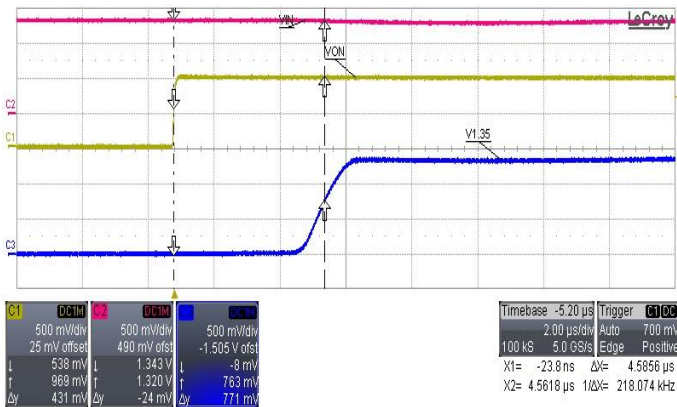

Turn off TOFF from VON, VIN=1.35V, VBIAS=5V
CH1:VIN, CH2:VON, CH3:VO

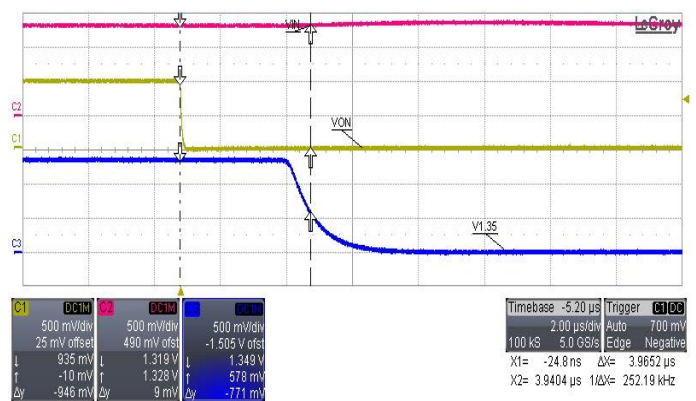

Turn off TF from VON, VIN=1.35V, VBIAS=5V
CH1:VIN, CH2:VON, CH3:VO

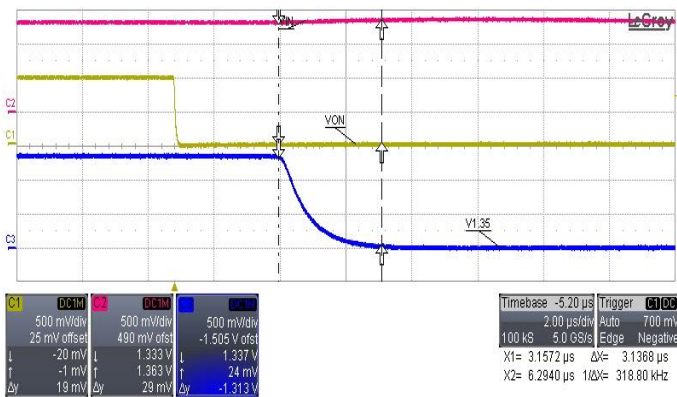

Von to Vo Ready, VIN=1.35V, VBIAS=3.3V
CH1:VON, CH2:VIN, CH3:Vo

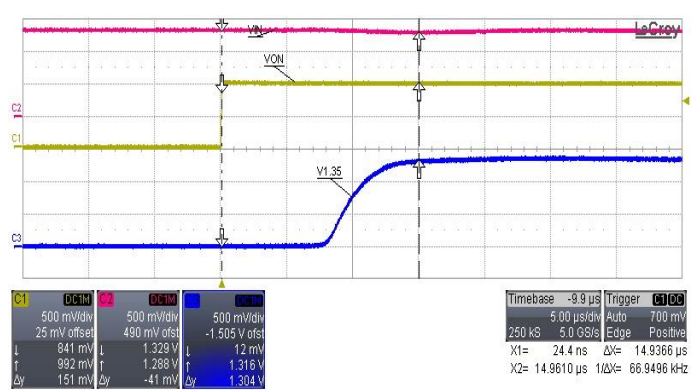

Von to Vo TD, VIN=1.35V, VBIAS=3.3V
CH1:VON, CH2:VIN, CH3:Vo

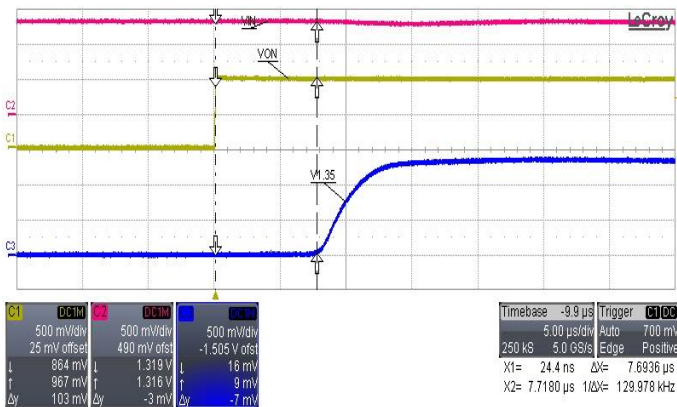

Rising time TR, VIN=1.35V, VBIAS=3.3V
CH1:VON, CH2:VIN, CH3:VO

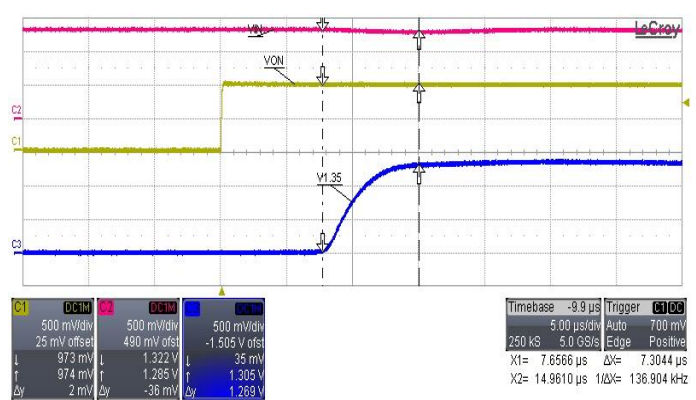

Turn off TOFF from VON, VIN=1.35V, VBIAS=3.3V
 CH1:VIN, CH2:VON, CH3:VO

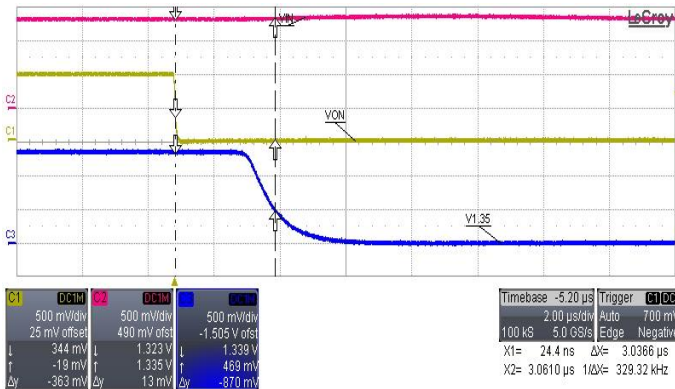

Turn off TF from VON, VIN=1.35V, VBIAS=3.3V
 CH1:VIN, CH2:VON, CH3:VO

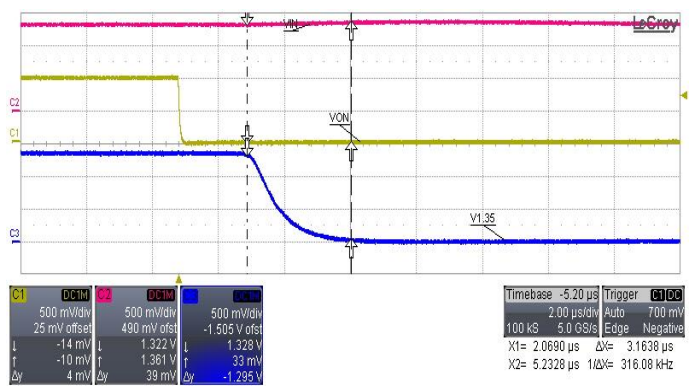

Von to Vo TD, VIN=2.5V, VBIAS=5V
 CH1:VON, CH2:VIN, CH3:Vo

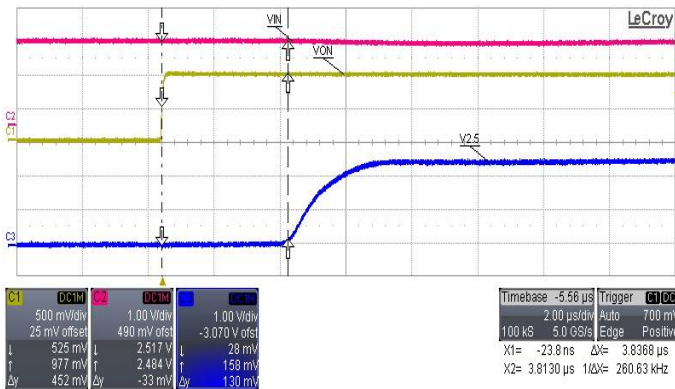

Rising time TR, VIN=2.5V, VBIAS=5V
 CH1:VON, CH2:VIN, CH3:Vo

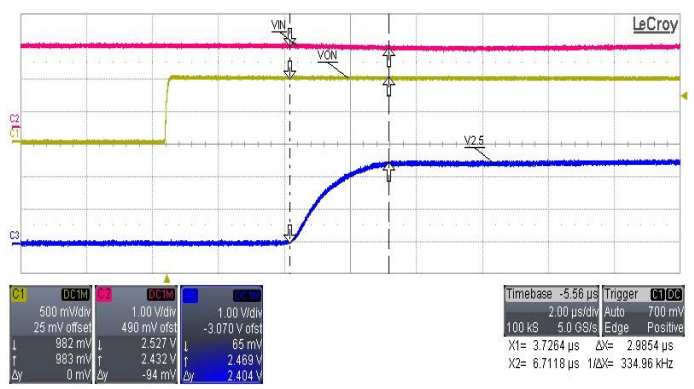

Von to Vo Ready, VIN=2.5V, VBIAS=5V
 CH1:VON, CH2:VIN, CH3:Vo

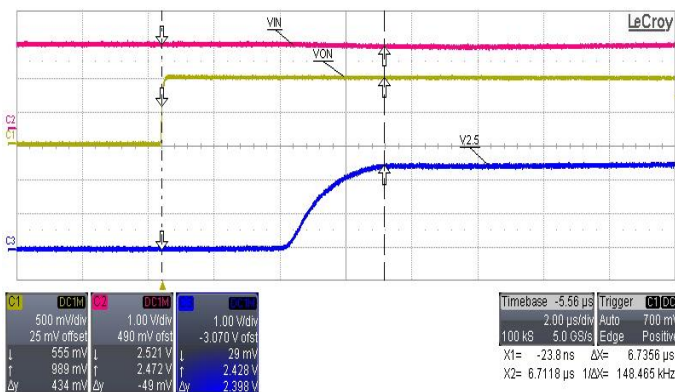

Von to Vo TOFF, VIN=2.5V, VBIAS=5V
 CH1:VON, CH2:VIN, CH3:Vo

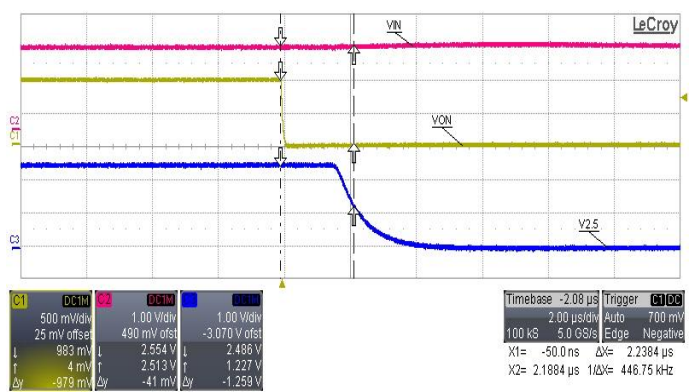

Von to Vo TF, VIN=2.5V, VBIAS=5V
 CH1:VON, CH2:VIN, CH3:Vo

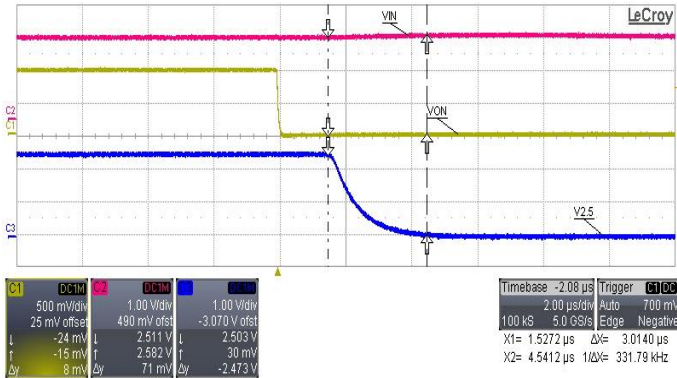

Turn off when no load
 CH1:VON, CH2:VIN, CH3:IN

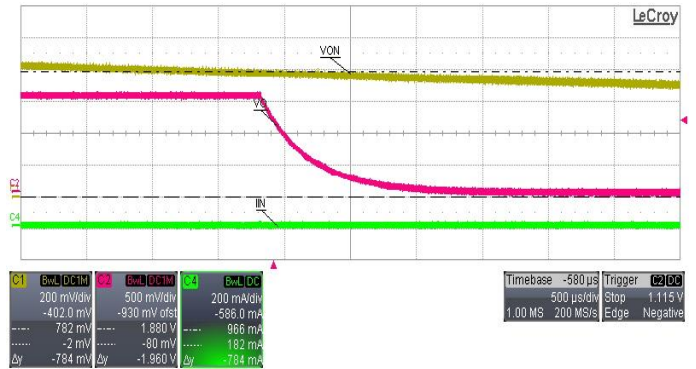

BIAS Supply Current VS. Temperature
 VIN=1V, VBIAS=3V to 5.5V

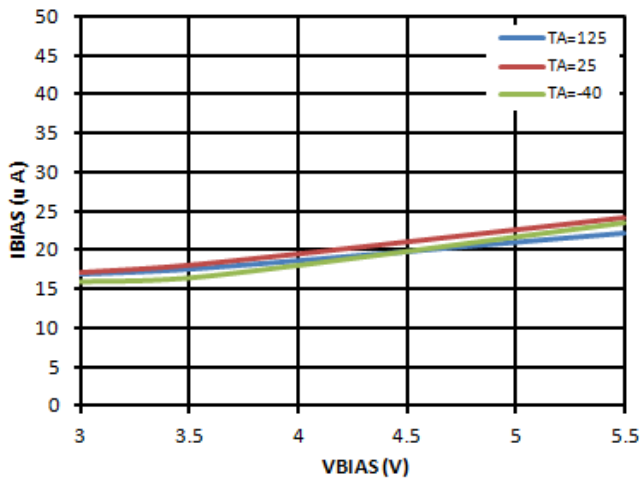

BIAS Shunt down Current VS. Temperature
 VIN=1V, VBIAS=3V to 5.5V

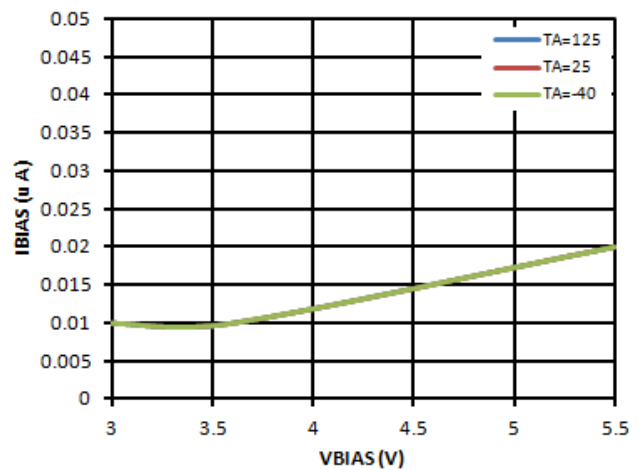

RPD Performance VS. Temperature
 VIN=1V, VBIAS=3V to 5.5V

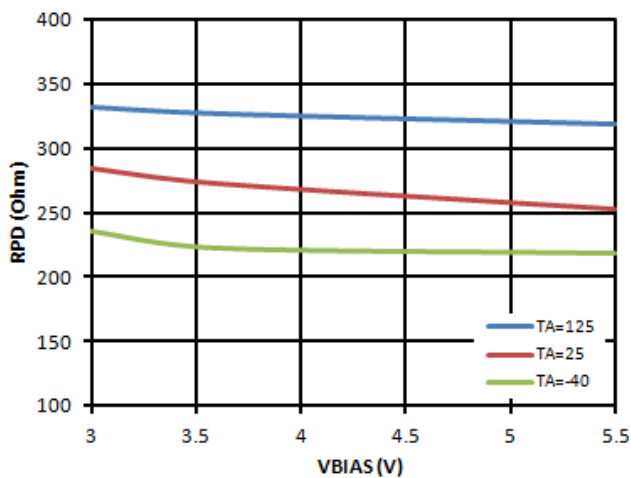

Output Rising Time VS. VIN VS. VBIAS
 VIN=0.8V to 3V, VBIAS=3V to 5.5V

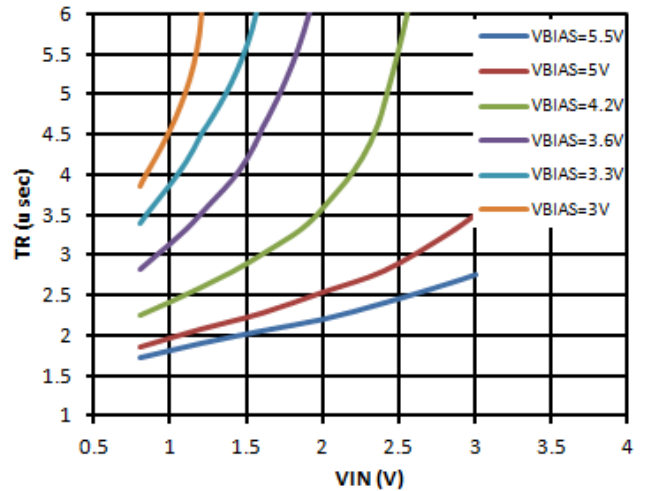

Functional Description

VIN and VBIAS Voltage Range

The MOSFET gate voltage in the EM5201B is driven by an internal charge pump. The output voltage of the charge pump is dependent on the voltage on VBIAS pin. Care must be taken to ensure a sufficient VBIAS is used to keep the desired output rising time when given the anticipated input voltage. For quickly output rising requirement that may be under 60usec, make sure $V_{IN} \leq (V_{BIAS} - 2V)$ is highly recommended. For example, in order to have $V_{IN}=3V$, VBIAS must be 5V. The Ron of EM5201BJ will still be keep constant if $V_{IN} > (V_{BIAS} - 2V)$ but it will exhibit slowly output rising time. See figure as below.

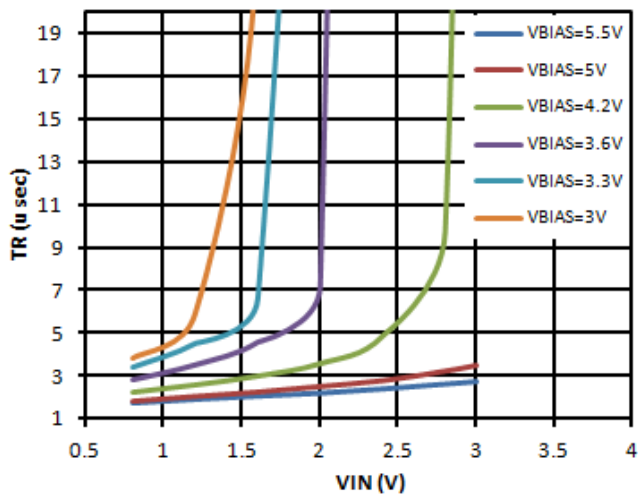

ON/OFF Control

EM5201B is enabled if the voltage of the Von pin is greater than logic high level and the VBIAS voltage has an adequate applied. If the voltage of the EN pin is less than logic low level, the device will be disabled.

Input Capacitor CIN

The EM5201B do not require an input capacitor. In order to limit the voltage drop on the input supply caused by transient inrush current, an input bypass capacitor is recommended. A 1uF ceramic capacitor should be placed as closed as possible to the VIN pin. Higher values capacitor can help to further reduce the

voltage drop.

Output Capacitor Co

Due to the integrated body diode in the NMOS switch, the CIN greater than Co is highly recommended. A CIN to Co ratio of 10 to 1 is recommended for minimizing VIN drop caused by inrush during startup. It also helps to prevent parasitic inductance forces Vo below GND when switching off. A 0.1uF ceramic capacitor should be placed as closed as possible to the Vo pin.

Thermal and Layout Consideration

EM5201B is designed to maintain a constant output load current. Due to physical limitations of the chip layout and assembly of the device the maximum switch current is 4.5A. All copper traces for the VIN and Vo pin should be widely and short to carry the maximum continuous current and obtain the best effect. The input and output capacitor should be close to the device as possible to minimize the parasitic trace inductances and prevents the voltage drop when load transient.

The maximum IC junction temperature should be restricted to 125°C under normal operating conditions. To calculate the maximum allowable dissipation, PD(MAX) for a given output current and ambient temperature, used the following equation:

$$P_{D(MAX)} = \frac{T_{J(MAX)} - T_A}{\theta_{JA}}$$

Where:

PD(MAX)=Maximum allowable power dissipation

TJ(MAX)=Maximum allowable junction temperature (125 °C for the EM5201B)

TA=Ambient Temperature of the device

θJA= Junction to air thermal impedance. This parameter is also dependent upon PCB layout.

Ordering & Marking Information

Device Name: EM5201BJ-45 for SOT23-6

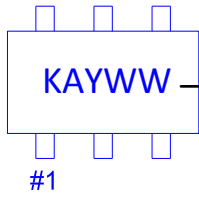

KA: Device Code, KA for EM5201BJ-45
 YWW: Date Code

Outline Drawing

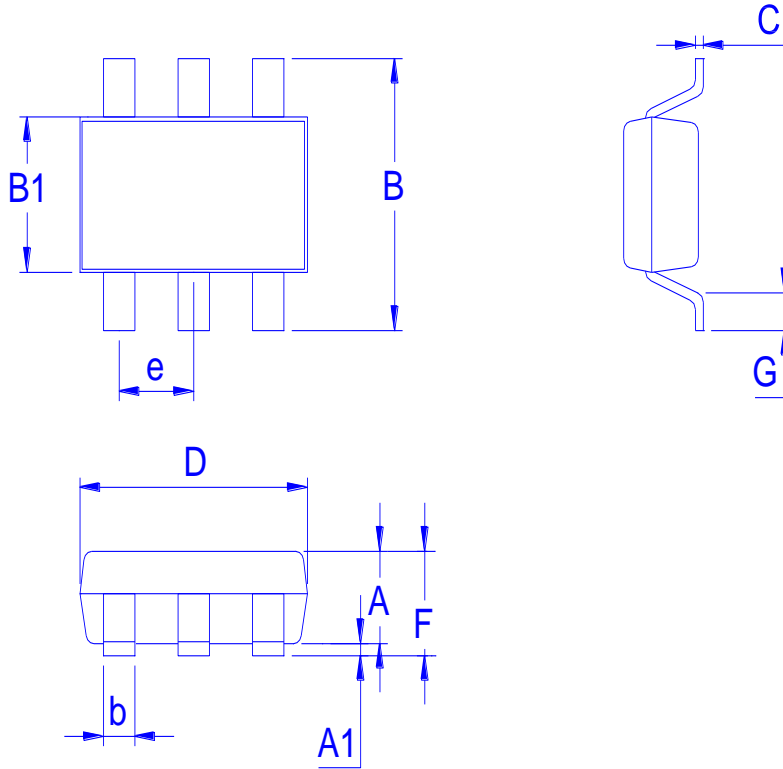

Dimension in mm

Dimension	A	A1	B	B1	b	C	D	e	F	G
Min.	0.90	0.00			0.30	0.08				0.30
Typ.	1.15		2.80	1.60			2.90	0.95		0.45
Max.	1.30	0.15			0.50	0.22			1.45	0.60

Recommended minimum pads

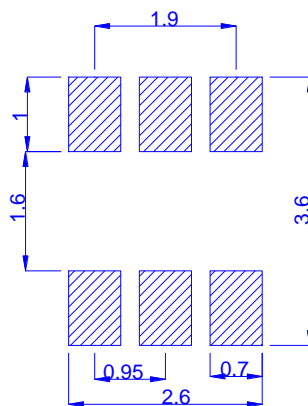



◆ Tape&Reel Information:3000pcs/Reel(Dimension in millimeter)

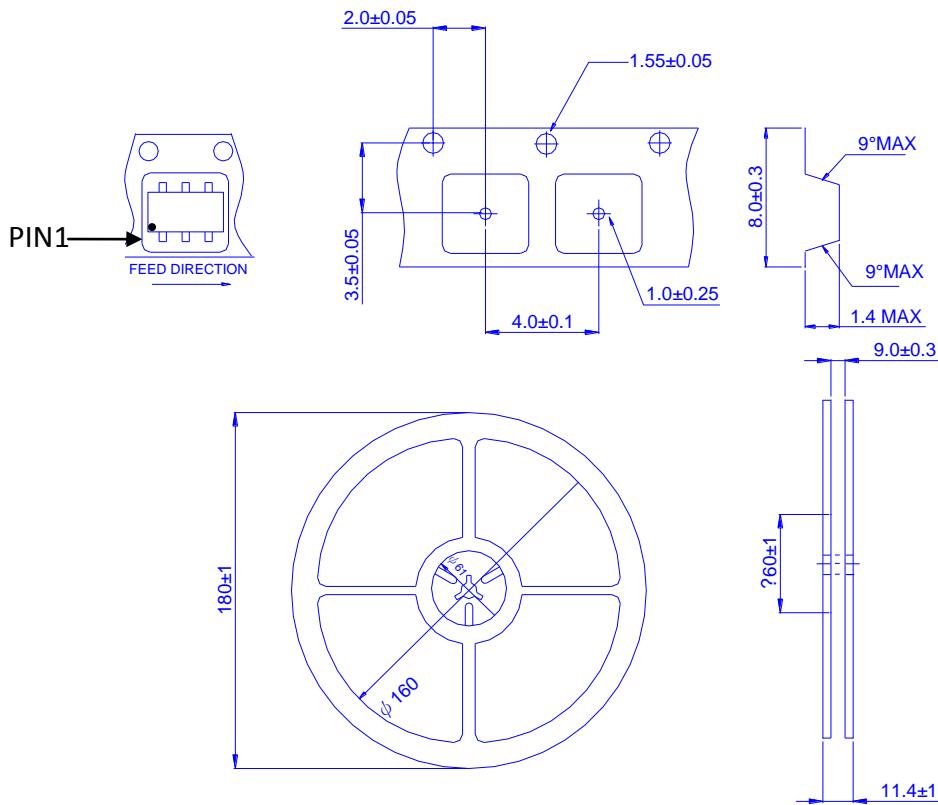

產品別	SOT23-6
Reel 尺寸	7"
編帶方式	<p>FEED DIRECTION</p>
50	50
50	50
裝箱數	
3K	3K
5 : 1	5 : 1
15K	15K
12 : 1	12 : 1
180K	180K