

EMC2DXV5T1G, EMC3DXV5T1G, EMC4DXV5T1G, EMC5DXV5T1G



ON Semiconductor®

<http://onsemi.com>

Dual Common Base-Collector Bias Resistor Transistors

NPN and PNP Silicon Surface Mount Transistors with Monolithic Bias Resistor Network

The BRT (Bias Resistor Transistor) contains a single transistor with a monolithic bias network consisting of two resistors; a series base resistor and a base-emitter resistor. These digital transistors are designed to replace a single device and its external resistor bias network. The BRT eliminates these individual components by integrating them into a single device. In the EMC2DXV5T1G series, two complementary BRT devices are housed in the SOT-553 package which is ideal for low power surface mount applications where board space is at a premium.

Features

- Simplifies Circuit Design
- Reduces Board Space
- Reduces Component Count
- NSV Prefix for Automotive and Other Applications Requiring Unique Site and Control Change Requirements; AEC-Q101 Qualified and PPAP Capable
- These are Pb-Free Devices

MAXIMUM RATINGS ($T_A = 25^\circ\text{C}$ unless otherwise noted, common for Q_1 and Q_2 , - minus sign for Q_1 (PNP) omitted)

Rating	Symbol	Value	Unit
Collector-Base Voltage	V_{CBO}	50	Vdc
Collector-Emitter Voltage	V_{CEO}	50	Vdc
Collector Current	I_C	100	mAdc

Stresses exceeding those listed in the Maximum Ratings table may damage the device. If any of these limits are exceeded, device functionality should not be assumed, damage may occur and reliability may be affected.

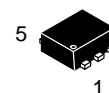
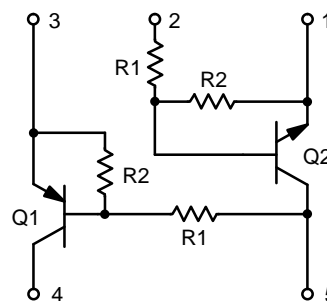

SOT-553
CASE 463B

MARKING DIAGRAM

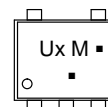

Ux = Specific Device Code
x = C, 3, E, or 5

M = Date Code

▪ = Pb-Free Package

(Note: Microdot may be in either location)

ORDERING INFORMATION

See detailed ordering and shipping information in the package dimensions section on page 2 of this data sheet.

EMC2DXV5T1G, EMC3DXV5T1G, EMC4DXV5T1G, EMC5DXV5T1G

THERMAL CHARACTERISTICS

Characteristic	Symbol	Max	Unit
ONE JUNCTION HEATED			
Total Device Dissipation $T_A = 25^\circ\text{C}$ Derate above 25°C	P_D	357 (Note 1) 2.9 (Note 1)	mW mW/ $^\circ\text{C}$
Thermal Resistance, Junction-to-Ambient	$R_{\theta JA}$	350 (Note 1)	$^\circ\text{C/W}$
BOTH JUNCTIONS HEATED			
Total Device Dissipation $T_A = 25^\circ\text{C}$ Derate above 25°C	P_D	500 (Note 1) 4.0 (Note 1)	mW mW/ $^\circ\text{C}$
Thermal Resistance, Junction-to-Ambient	$R_{\theta JA}$	250 (Note 1)	$^\circ\text{C/W}$
Junction and Storage Temperature	T_J, T_{stg}	-55 to +150	$^\circ\text{C}$

1. FR-4 @ Minimum Pad

DEVICE ORDERING INFORMATION, MARKING AND RESISTOR VALUES

Device	Marking	Transistor 1 – PNP		Transistor 2 – NPN		Package	Shipping†
		R1 (K)	R2 (K)	R1 (K)	R2 (K)		
EMC2DXV5T1G	UC	22	22	22	22	SOT-553 (Pb-Free)	4000 / Tape & Reel
NSVEMC2DXV5T1G*	UC	22	22	22	22		4000 / Tape & Reel
EMC3DXV5T1G	U3	10	10	10	10		4000 / Tape & Reel
EMC3DXV5T5G							8000 / Tape & Reel
EMC4DXV5T1G	UE	10	47	47	47		4000 / Tape & Reel
EMC5DXV5T1G	U5	4.7	10	47	47		4000 / Tape & Reel

†For information on tape and reel specifications, including part orientation and tape sizes, please refer to our Tape and Reel Packaging Specifications Brochure, BRD8011/D.

*NSV Prefix for Automotive and Other Applications Requiring Unique Site and Control Change Requirements; AEC-Q101 Qualified and PPAP Capable.

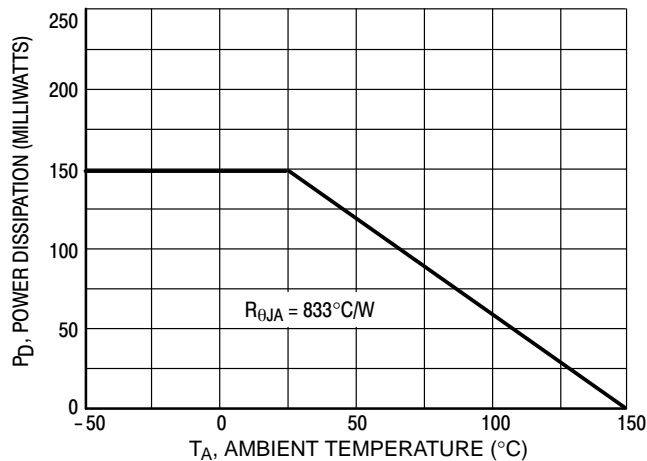

Figure 1. Derating Curve

EMC2DXV5T1G, EMC3DXV5T1G, EMC4DXV5T1G, EMC5DXV5T1G

ELECTRICAL CHARACTERISTICS (T_A = 25°C unless otherwise noted)

Characteristic	Symbol	Min	Typ	Max	Unit
Q1 TRANSISTOR: PNP OFF CHARACTERISTICS					
Collector-Base Cutoff Current (V _{CB} = 50 V, I _E = 0)	I _{CBO}	–	–	100	nAdc
Collector-Emitter Cutoff Current (V _{CB} = 50 V, I _B = 0)	I _{CEO}	–	–	500	nAdc
Emitter-Base Cutoff Current (V _{EB} = 6.0 V, I _C = 0)	I _{EBO}	–	–	0.2	mAdc
	EMC2DXV5T1G	–	–	0.5	
	EMC3DXV5T1G	–	–	0.2	
	EMC4DXV5T1G	–	–	1.0	
	EMC5DXV5T1G	–	–	–	

ON CHARACTERISTICS

Collector-Base Breakdown Voltage (I _C = 10 μA, I _E = 0)	V _{(BR)CBO}	50	–	–	Vdc
Collector-Emitter Breakdown Voltage (I _C = 2.0 mA, I _B = 0)	V _{(BR)CEO}	50	–	–	Vdc
DC Current Gain (V _{CE} = 10 V, I _C = 5.0 mA)	h _{FE}	60	100	–	
	EMC2DXV5T1G	35	60	–	
	EMC3DXV5T1G	80	140	–	
	EMC4DXV5T1G	20	35	–	
	EMC5DXV5T1G	–	–	–	
Collector-Emitter Saturation Voltage (I _C = 10 mA, I _B = 0.3 mA)	V _{CE(SAT)}	–	–	0.25	Vdc
Output Voltage (on) (V _{CC} = 5.0 V, V _B = 2.5 V, R _L = 1.0 kΩ)	V _{OL}	–	–	0.2	Vdc
Output Voltage (off) (V _{CC} = 5.0 V, V _B = 0.5 V, R _L = 1.0 kΩ)	V _{OH}	4.9	–	–	Vdc
Input Resistor	R1	15.4	22	28.6	kΩ
	EMC2DXV5T1G	7.0	10	13	
	EMC3DXV5T1G	3.3	4.7	6.1	
	EMC4DXV5T1G	–	–	–	
	EMC5DXV5T1G	–	–	–	
Resistor Ratio	R1/R2	0.8	1.0	1.2	
	EMC2DXV5T1G	0.8	1.0	1.2	
	EMC3DXV5T1G	0.17	0.21	0.25	
	EMC4DXV5T1G	0.38	0.47	0.56	
	EMC5DXV5T1G	–	–	–	

Q2 TRANSISTOR: NPN OFF CHARACTERISTICS

Collector-Base Cutoff Current (V _{CB} = 50 V, I _E = 0)	I _{CBO}	–	–	100	nAdc
Collector-Emitter Cutoff Current (V _{CB} = 50 V, I _B = 0)	I _{CEO}	–	–	500	nAdc
Emitter-Base Cutoff Current (V _{EB} = 6.0 V, I _C = 0)	I _{EBO}	–	–	0.2	mAdc
	EMC2DXV5T1G	–	–	0.5	
	EMC3DXV5T1G	–	–	0.1	
	EMC4DXV5T1G, EMC5DXV5T1G	–	–	–	

ON CHARACTERISTICS

Collector-Base Breakdown Voltage (I _C = 10 μA, I _E = 0)	V _{(BR)CBO}	50	–	–	Vdc
Collector-Emitter Breakdown Voltage (I _C = 2.0 mA, I _B = 0)	V _{(BR)CEO}	50	–	–	Vdc
DC Current Gain (V _{CE} = 10 V, I _C = 5.0 mA)	h _{FE}	60	100	–	
	EMC2DXV5T1G	35	60	–	
	EMC3DXV5T1G	80	140	–	
	EMC4DXV5T1G, EMC5DXV5T1G	–	–	–	
Collector-Emitter Saturation Voltage (I _C = 10 mA, I _B = 0.3 mA)	V _{CE(SAT)}	–	–	0.25	Vdc
Output Voltage (on) (V _{CC} = 5.0 V, V _B = 2.5 V, R _L = 1.0 kΩ)	V _{OL}	–	–	0.2	Vdc
Output Voltage (off) (V _{CC} = 5.0 V, V _B = 0.5 V, R _L = 1.0 kΩ)	V _{OH}	4.9	–	–	Vdc
Input Resistor	R1	15.4	22	28.6	kΩ
	EMC2DXV5T1G	7.0	10	13	
	EMC3DXV5T1G	33	47	61	
	EMC4DXV5T1G, EMC5DXV5T1G	–	–	–	
Resistor Ratio	R1/R2	0.8	1.0	1.2	
	EMC2DXV5T1G	0.8	1.0	1.2	
	EMC3DXV5T1G	0.8	1.0	1.2	
	EMC4DXV5T1G, EMC5DXV5T1G	0.8	1.0	1.2	

Product parametric performance is indicated in the Electrical Characteristics for the listed test conditions, unless otherwise noted. Product performance may not be indicated by the Electrical Characteristics if operated under different conditions.

EMC2DXV5T1G, EMC3DXV5T1G, EMC4DXV5T1G, EMC5DXV5T1G

TYPICAL ELECTRICAL CHARACTERISTICS – EMC2DXV5T1 PNP TRANSISTOR

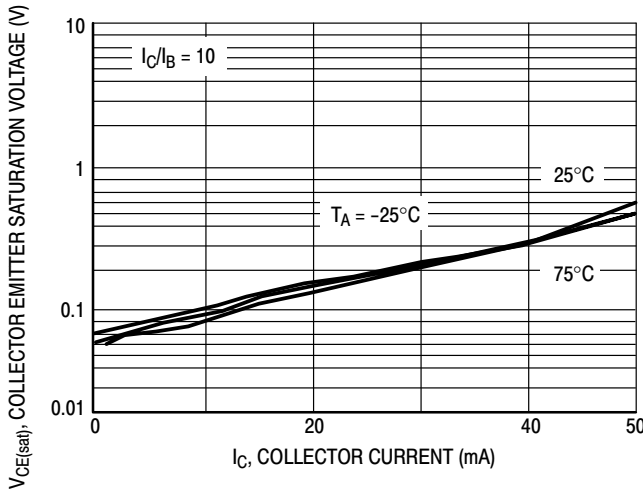

Figure 2. $V_{CE(sat)}$ versus I_C

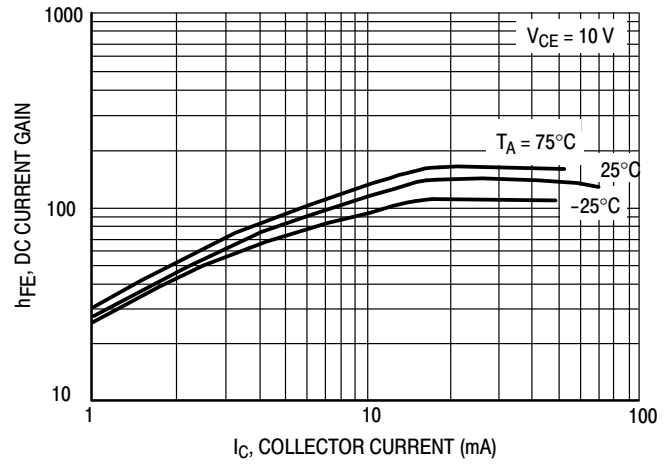

Figure 3. DC Current Gain

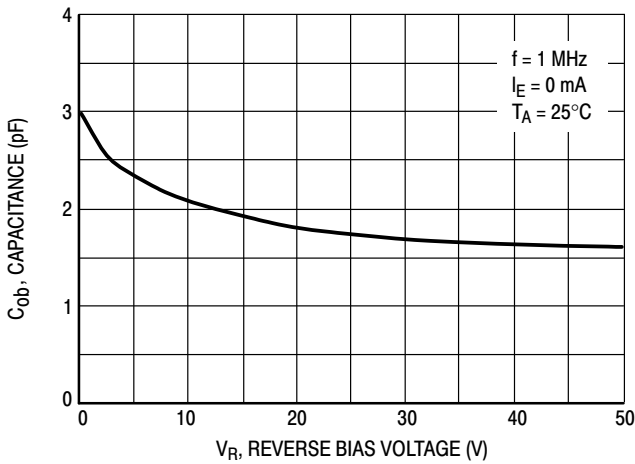

Figure 4. Output Capacitance

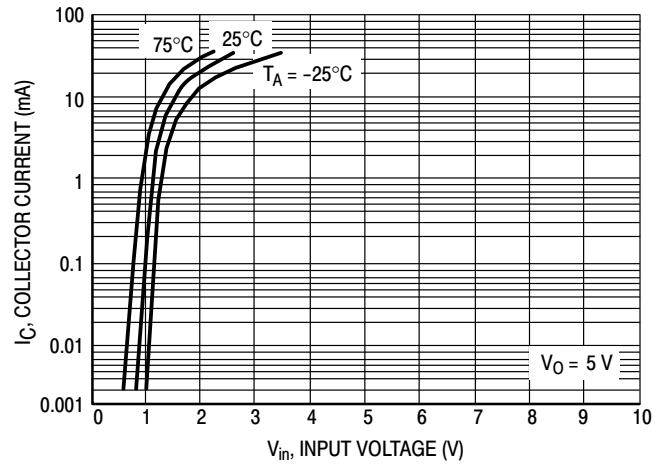

Figure 5. Output Current versus Input Voltage

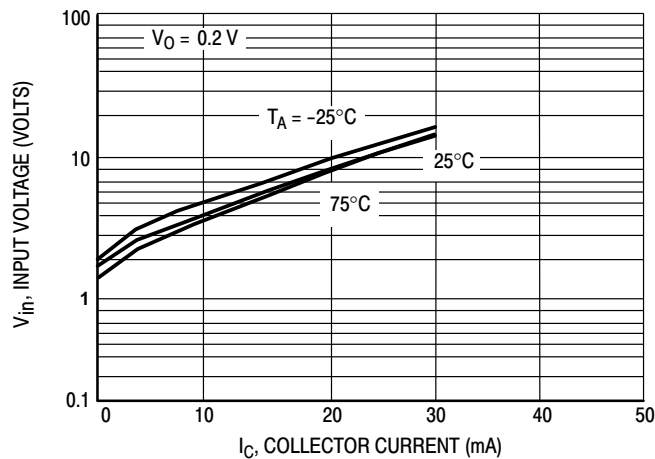

Figure 6. Input Voltage versus Output Current

EMC2DXV5T1G, EMC3DXV5T1G, EMC4DXV5T1G, EMC5DXV5T1G

TYPICAL ELECTRICAL CHARACTERISTICS – EMC2DXV5T1 NPN TRANSISTOR

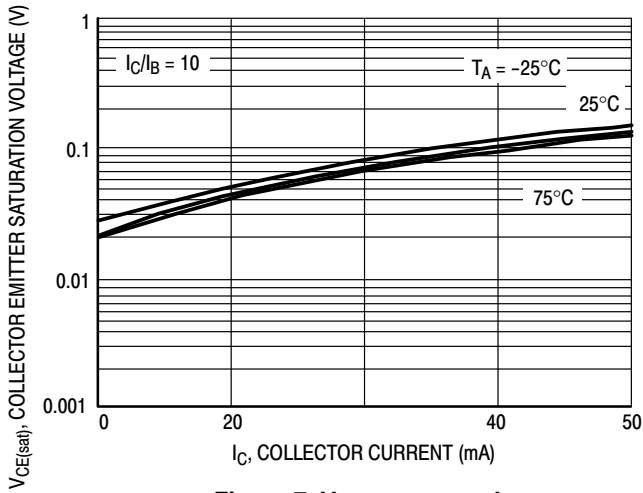

Figure 7. $V_{CE(sat)}$ versus I_C

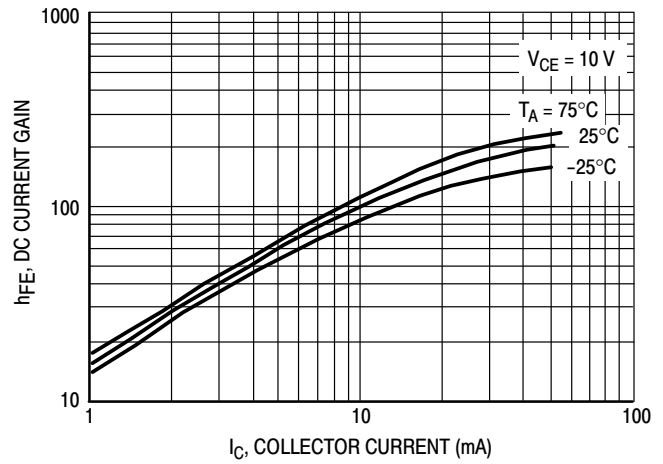

Figure 8. DC Current Gain

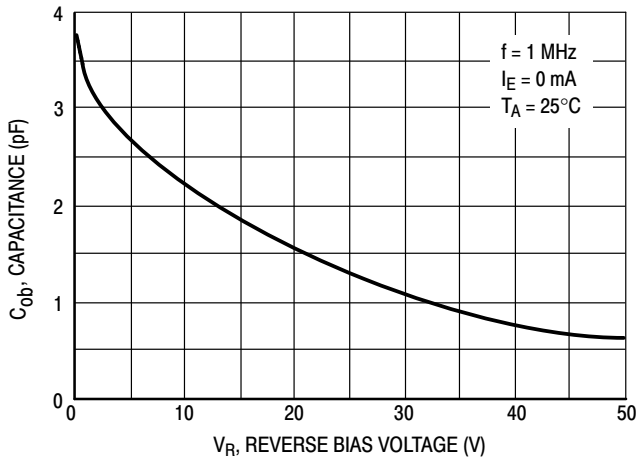

Figure 9. Output Capacitance

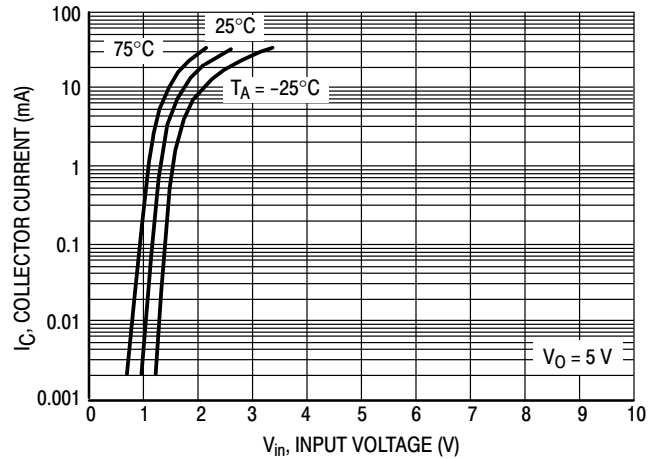

Figure 10. Output Current versus Input Voltage

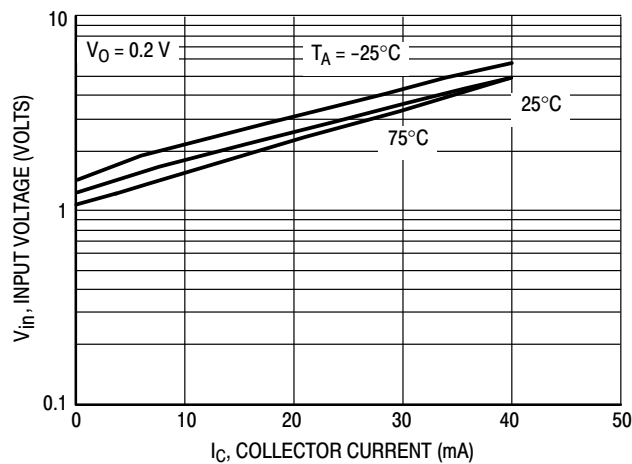

Figure 11. Input Voltage versus Output Current

EMC2DXV5T1G, EMC3DXV5T1G, EMC4DXV5T1G, EMC5DXV5T1G

TYPICAL ELECTRICAL CHARACTERISTICS – EMC3DXV5T1 PNP TRANSISTOR

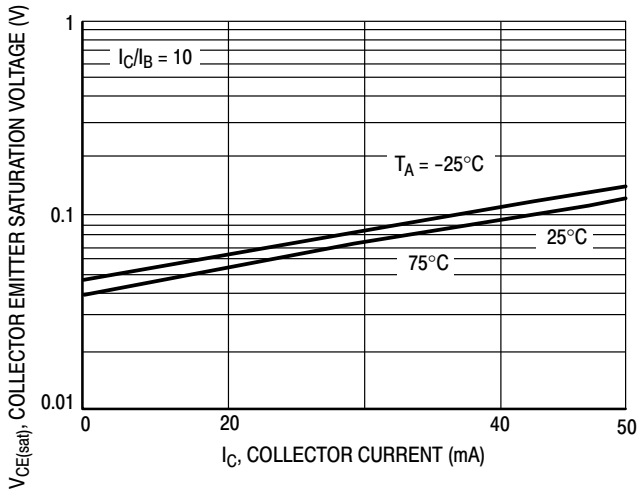

Figure 12. $V_{CE(sat)}$ versus I_C

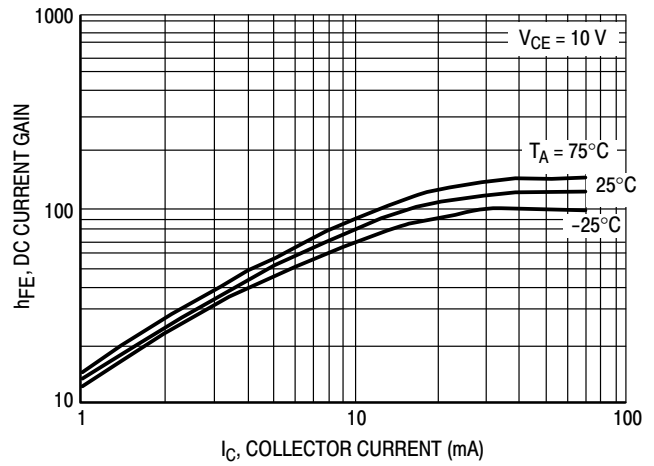

Figure 13. DC Current Gain

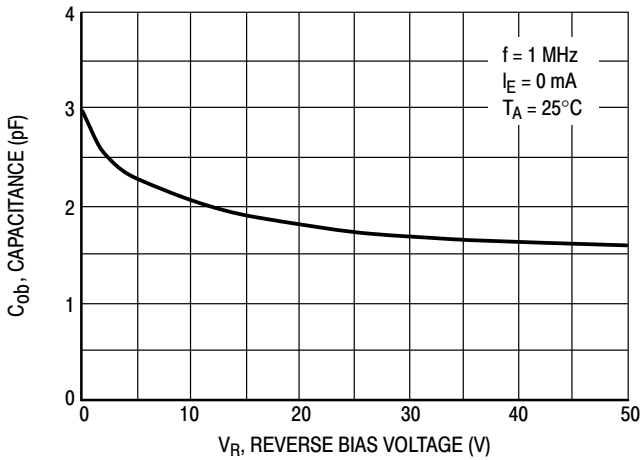

Figure 14. Output Capacitance

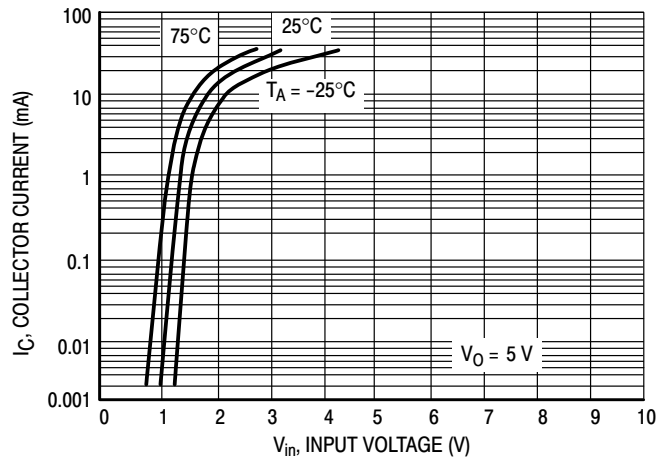

Figure 15. Output Current versus Input Voltage

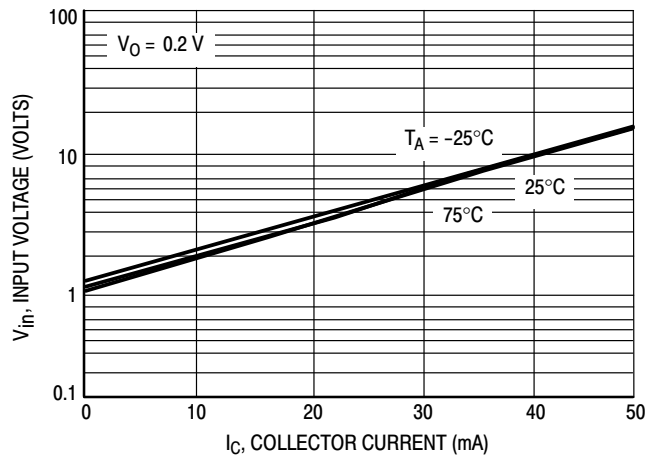

Figure 16. Input Voltage versus Output Current

EMC2DXV5T1G, EMC3DXV5T1G, EMC4DXV5T1G, EMC5DXV5T1G

TYPICAL ELECTRICAL CHARACTERISTICS – EMC3DXV5T1 NPN TRANSISTOR

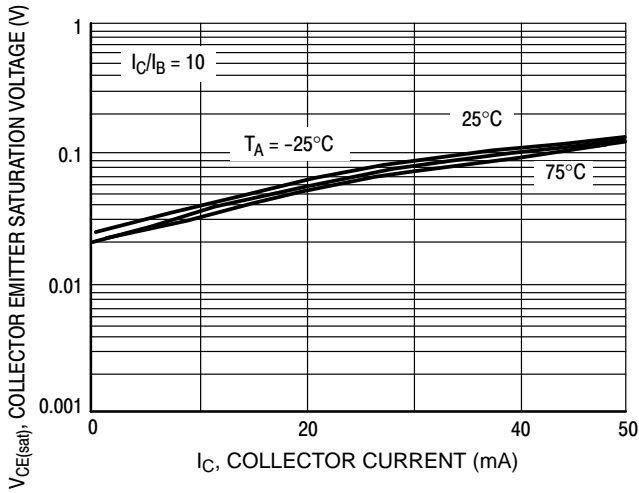

Figure 17. $V_{CE(sat)}$ versus I_C

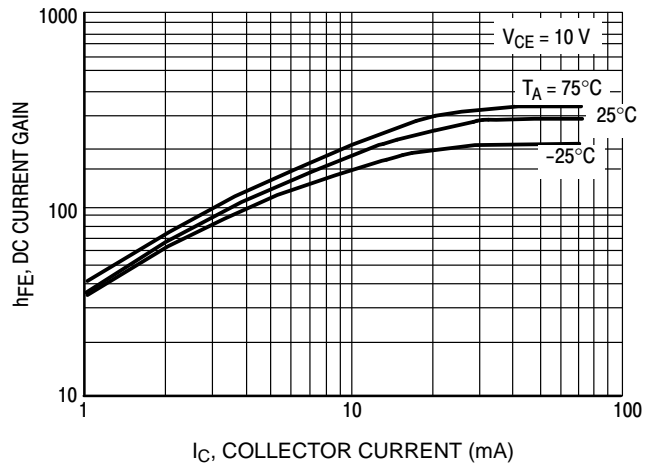

Figure 18. DC Current Gain

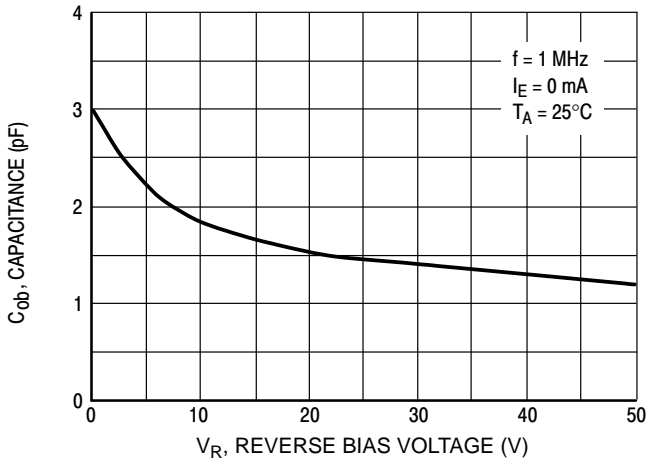

Figure 19. Output Capacitance

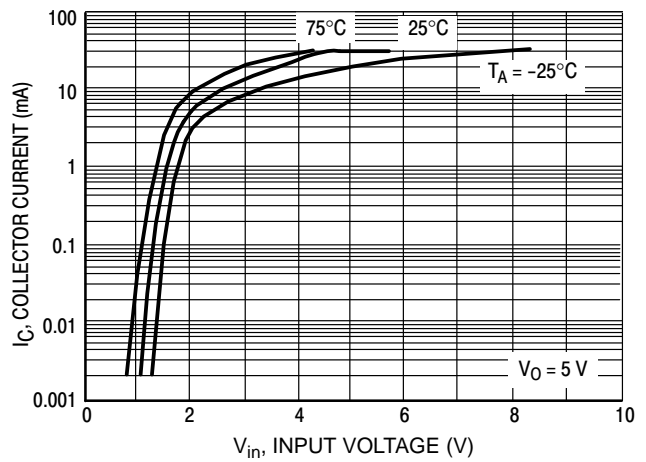

Figure 20. Output Current versus Input Voltage

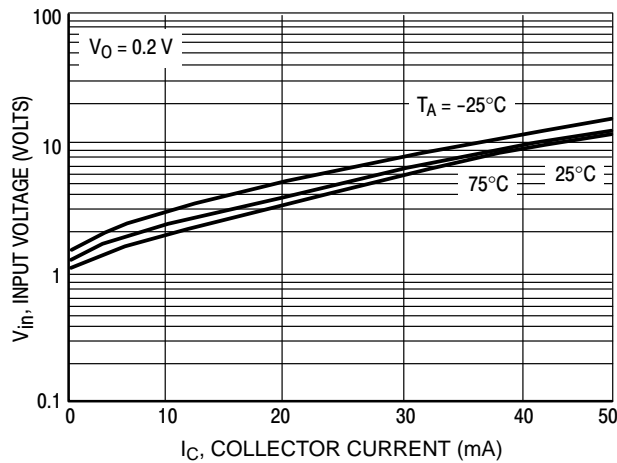

Figure 21. Input Voltage versus Output Current

EMC2DXV5T1G, EMC3DXV5T1G, EMC4DXV5T1G, EMC5DXV5T1G

TYPICAL ELECTRICAL CHARACTERISTICS – EMC4DXV5T1 PNP TRANSISTOR

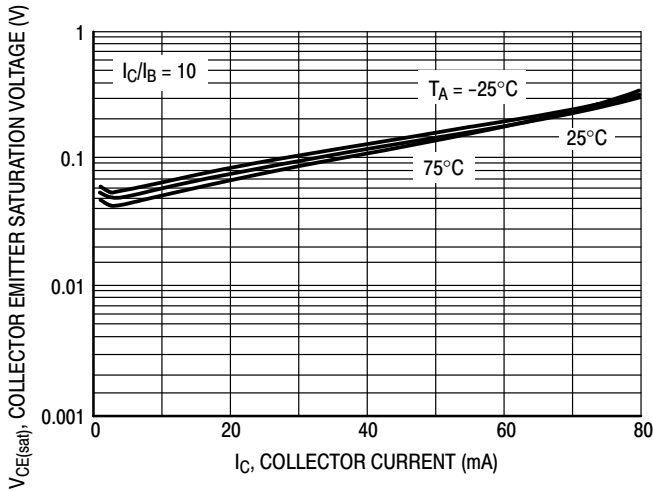

Figure 22. $V_{CE(sat)}$ versus I_C

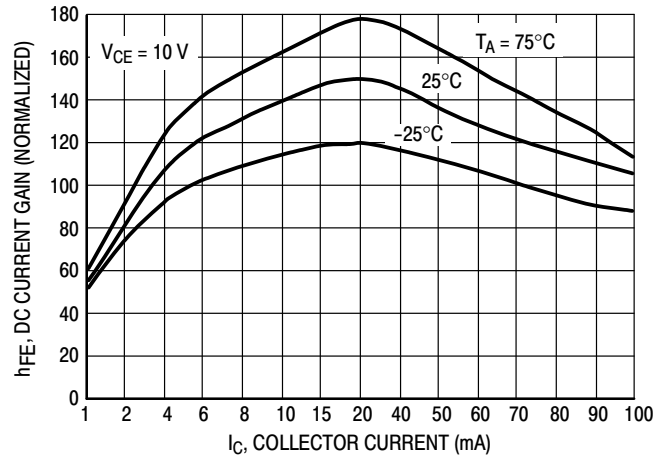

Figure 23. DC Current Gain

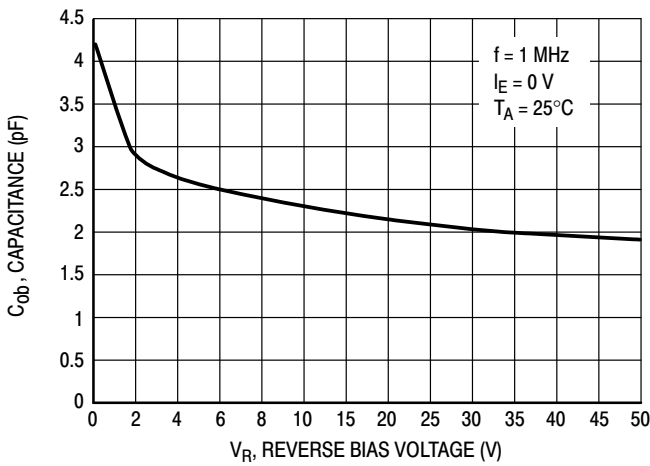

Figure 24. Output Capacitance

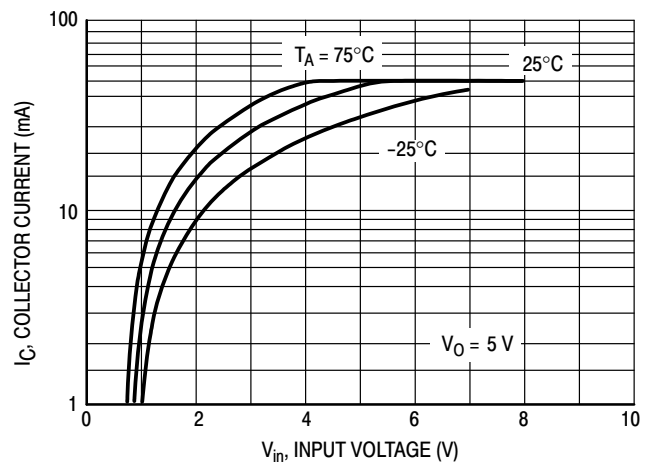

Figure 25. Output Current versus Input Voltage

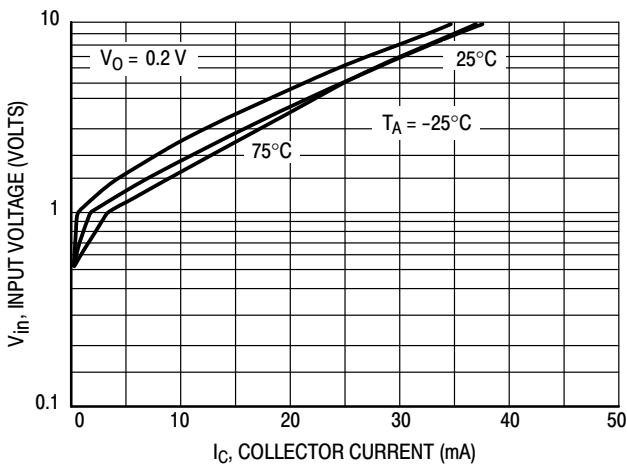

Figure 26. Input Voltage versus Output Current

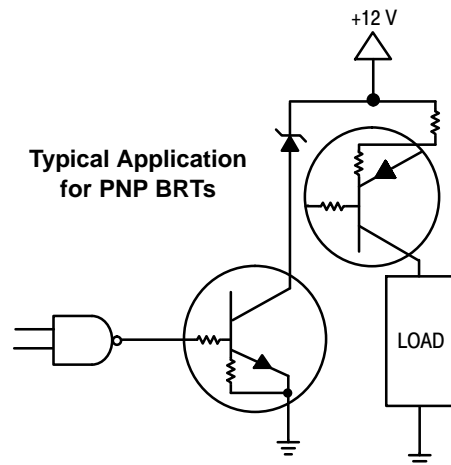

Figure 27. Inexpensive, Unregulated Current Source

EMC2DXV5T1G, EMC3DXV5T1G, EMC4DXV5T1G, EMC5DXV5T1G

TYPICAL ELECTRICAL CHARACTERISTICS – EMC5DXV5T1 PNP TRANSISTOR

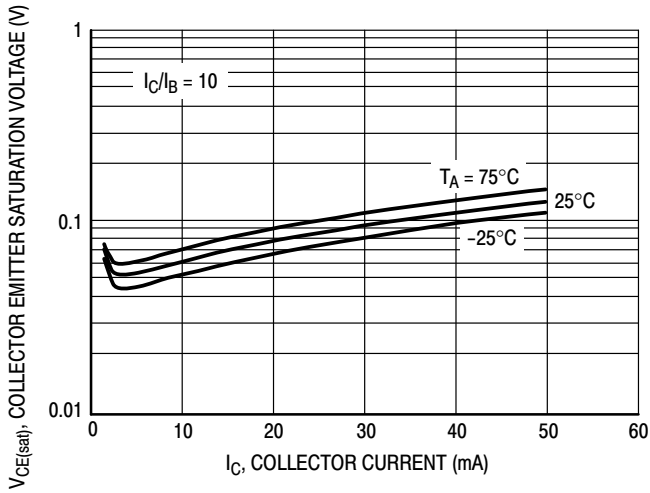

Figure 28. $V_{CE(sat)}$ versus I_C

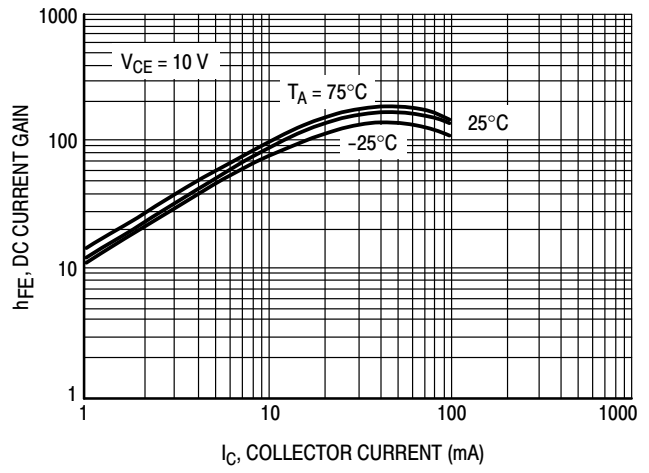

Figure 29. DC Current Gain

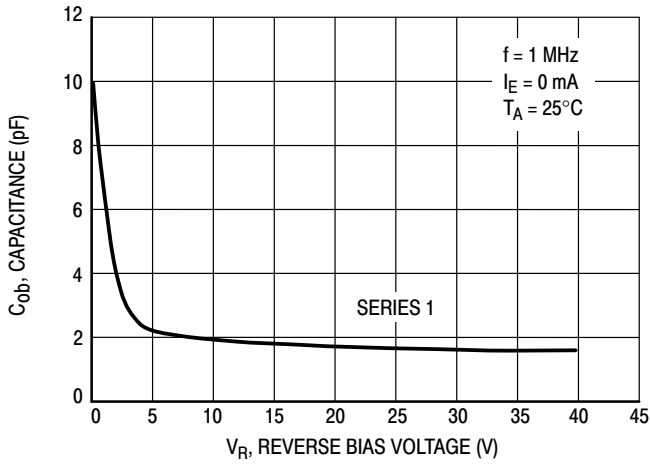

Figure 30. Output Capacitance

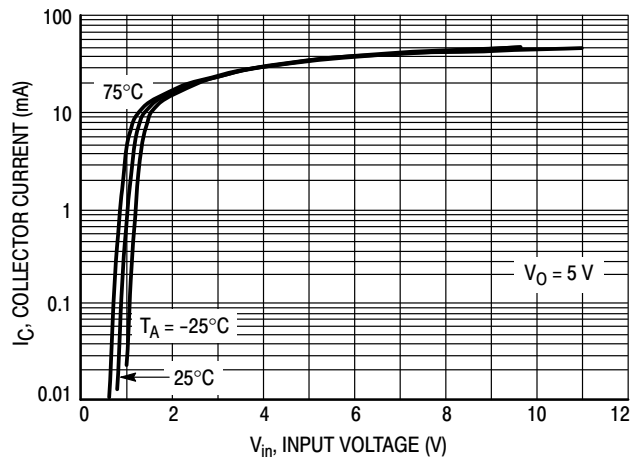

Figure 31. Output Current versus Input Voltage

EMC2DXV5T1G, EMC3DXV5T1G, EMC4DXV5T1G, EMC5DXV5T1G

TYPICAL ELECTRICAL CHARACTERISTICS – EMC4DXV5T1, EMC5DXV5T1 NPN TRANSISTOR

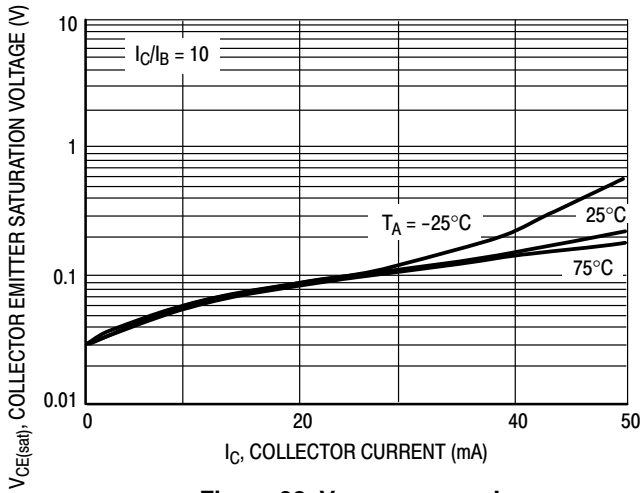

Figure 32. $V_{CE(sat)}$ versus I_C

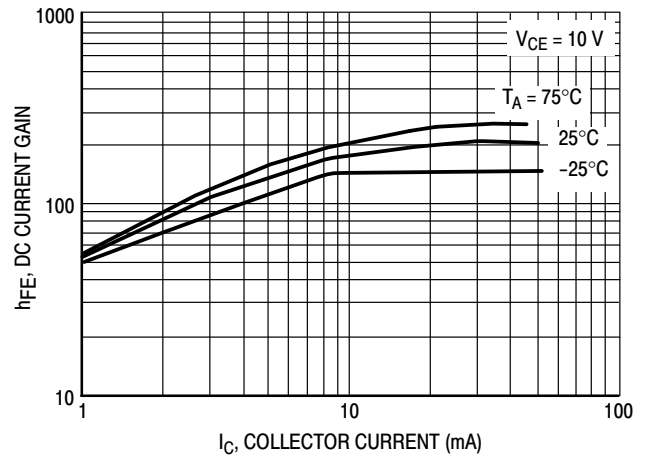

Figure 33. DC Current Gain

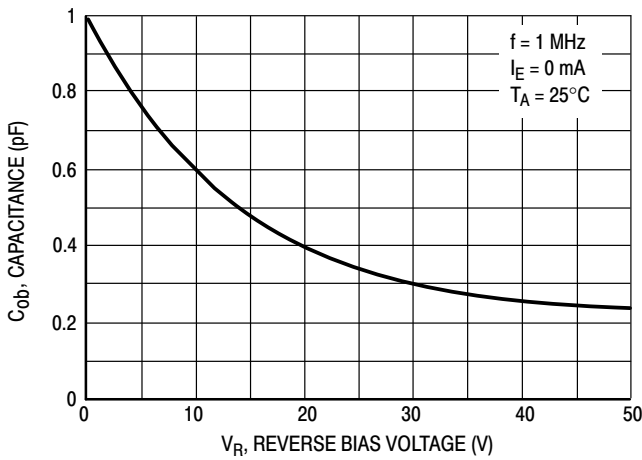

Figure 34. Output Capacitance

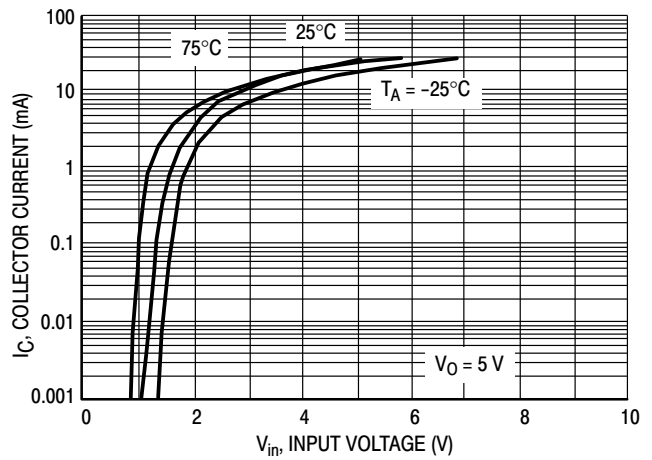

Figure 35. Output Current versus Input Voltage

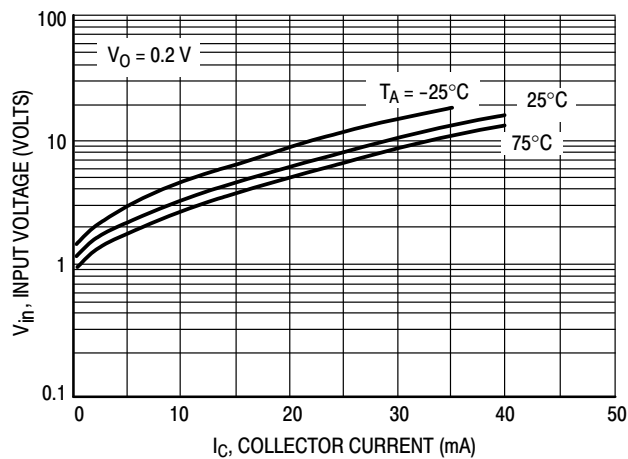
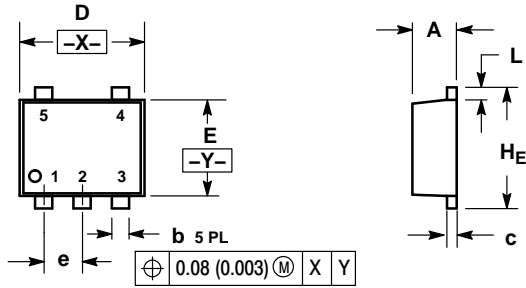

Figure 36. Input Voltage versus Output Current

EMC2DXV5T1G, EMC3DXV5T1G, EMC4DXV5T1G, EMC5DXV5T1G

PACKAGE DIMENSIONS

SOT-553, 5 LEAD CASE 463B ISSUE C



NOTES:

1. DIMENSIONING AND TOLERANCING PER ANSI Y14.5M, 1982.
2. CONTROLLING DIMENSION: MILLIMETERS
3. MAXIMUM LEAD THICKNESS INCLUDES LEAD FINISH THICKNESS. MINIMUM LEAD THICKNESS IS THE MINIMUM THICKNESS OF BASE MATERIAL.

DIM	MILLIMETERS			INCHES		
	MIN	NOM	MAX	MIN	NOM	MAX
A	0.50	0.55	0.60	0.020	0.022	0.024
b	0.17	0.22	0.27	0.007	0.009	0.011
c	0.08	0.13	0.18	0.003	0.005	0.007
D	1.55	1.60	1.65	0.061	0.063	0.065
E	1.15	1.20	1.25	0.045	0.047	0.049
e	0.50 BSC			0.020 BSC		
L	0.10	0.20	0.30	0.004	0.008	0.012
HE	1.55	1.60	1.65	0.061	0.063	0.065

RECOMMENDED SOLDERING FOOTPRINT*

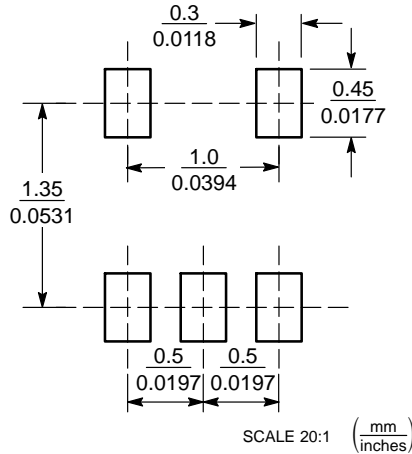

*For additional information on our Pb-Free strategy and soldering details, please download the ON Semiconductor Soldering and Mounting Techniques Reference Manual, SOLDERRM/D.

ON Semiconductor and are registered trademarks of Semiconductor Components Industries, LLC (SCILLC). SCILLC owns the rights to a number of patents, trademarks, copyrights, trade secrets, and other intellectual property. A listing of SCILLC's product/patent coverage may be accessed at www.onsemi.com/site/pdf/Patent-Marking.pdf. SCILLC reserves the right to make changes without further notice to any products herein. SCILLC makes no warranty, representation or guarantee regarding the suitability of its products for any particular purpose, nor does SCILLC assume any liability arising out of the application or use of any product or circuit, and specifically disclaims any and all liability, including without limitation special, consequential or incidental damages. "Typical" parameters which may be provided in SCILLC data sheets and/or specifications can and do vary in different applications and actual performance may vary over time. All operating parameters, including "Typicals" must be validated for each customer application by customer's technical experts. SCILLC does not convey any license under its patent rights nor the rights of others. SCILLC products are not designed, intended, or authorized for use as components in systems intended for surgical implant into the body, or other applications intended to support or sustain life, or for any other application in which the failure of the SCILLC product could create a situation where personal injury or death may occur. Should Buyer purchase or use SCILLC products for any such unintended or unauthorized application, Buyer shall indemnify and hold SCILLC and its officers, employees, subsidiaries, affiliates, and distributors harmless against all claims, costs, damages, and expenses, and reasonable attorney fees arising out of, directly or indirectly, any claim of personal injury or death associated with such unintended or unauthorized use, even if such claim alleges that SCILLC was negligent regarding the design or manufacture of the part. SCILLC is an Equal Opportunity/Affirmative Action Employer. This literature is subject to all applicable copyright laws and is not for resale in any manner.

PUBLICATION ORDERING INFORMATION

LITERATURE FULFILLMENT:
Literature Distribution Center for ON Semiconductor
P.O. Box 5163, Denver, Colorado 80217 USA
Phone: 303-675-2175 or 800-344-3860 Toll Free USA/Canada
Fax: 303-675-2176 or 800-344-3867 Toll Free USA/Canada
Email: orderlit@onsemi.com

N. American Technical Support: 800-282-9855 Toll Free
USA/Canada
Europe, Middle East and Africa Technical Support:
Phone: 421 33 790 2910
Japan Customer Focus Center
Phone: 81-3-5817-1050

ON Semiconductor Website: www.onsemi.com
Order Literature: <http://www.onsemi.com/orderlit>
For additional information, please contact your local Sales Representative