

## Regulated Switched Capacitor LED Current Source with Analog and PWM Brightness Control

### General Description

The EMD2794/EMD2795 is a 1.5x/1.0x charge pump that provides four regulated current sources. It accepts an input voltage range from 2.7V to 5.5V and maintains a constant current determined by an external resistor.

The EMD2794/EMD2795 delivers up to 80mA of load current to accommodate four White LEDs. The switching frequency is fixed at 1.2MHz to make noise filtering easier. Brightness control can be done by both linear and PWM techniques. Linear control is achieved by applying 0V to 3.0V to the BRGT pin to linearly vary the LED current. PWM technique is to apply a clock to the EN pin to having brightness varying with clock duty.

Shutdown is done by applying low (high for 2795) to the pin EN. The VIN current drops to less than 1.0uA in shutdown mode.

The EMD2794/EMD2795 is available in a TQFN-16 & FBP-16 3x3 package.

### Features

- Regulated current sources with  $\pm 0.5\%$  matching between any two outputs
- High efficiency 3/2 boost function
- Drives one to four white LEDs.
- 2.7V to 5.5V input range
- Up to 80mA output current
- Analog brightness control
- Active-low or high shutdown input ('94/95)
- Very small solution size and no inductor
- Shutdown Current  $< 1\mu\text{A}$
- 1.2MHz switching frequency
- Constant frequency generates predictable noise spectrum
- QFN16 3x3 package

### Applications

- White LED Display Backlights
- White LED Keypad Backlights
- 1-Cell Li-Ion battery-operated equipment including PDAs, hand-held PCs, cellular phones.

## Connection Diagram

## Order information

TQFN-16

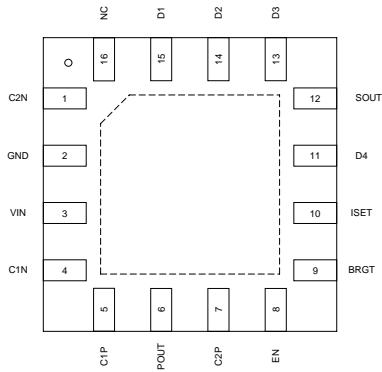

EMD2794-00HB16NRR / EMD2795-00HB16NRR

- 00 Voltage Option
- HB16 TQFN-16 Package
- N Green ; (RoHS & Halogen free)
- R Commercial Grade Temperature  
Rating: -40 to 85°C
- R Package in Tape & Reel

FBP-16

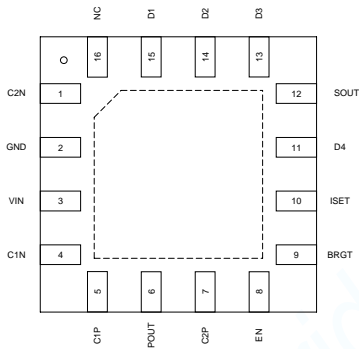

EMD2794-00BA16GRR / EMD2795-00BA16GRR

- 00 Voltage Option
- BA16 FBP-16 Package
- G RoHS( Pb free)
- R Commercial Grade Temperature  
Rating: -40 to 85°C
- R Package in Tape & Reel

*Elite MicroPower Inc. reserves the right to make changes to improve reliability or manufacturability without notice, and customers are advised to obtain the latest version of relevant information prior to placing orders.*

## Marking & Packing Information

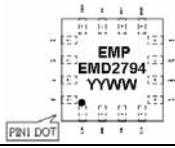
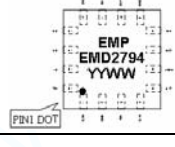
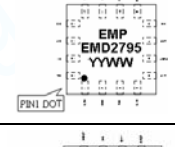
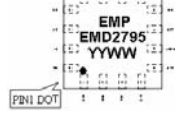
| Product ID | Package Type | Product ID        | Package Marking   | Transport Media      |
|------------|--------------|-------------------|---|----------------------|
| EMD2794    | TQFN-16      | EMD2794-00HB16NRR |    | 5K units Tape & Reel |
|            | FBP-16       | EMD2794-00BA16GRR |    |                      |
| EMD2795    | TQFN-16      | By Request        |   | 5K units Tape & Reel |
|            | FBP-16       | By Request        |  |                      |

YY: Year Code

WW: Weekly Code

*Elite MicroPower Inc. reserves the right to make changes to improve reliability or manufacturability without notice, and customers are advised to obtain the latest version of relevant information prior to placing orders.*

## Typical Applications

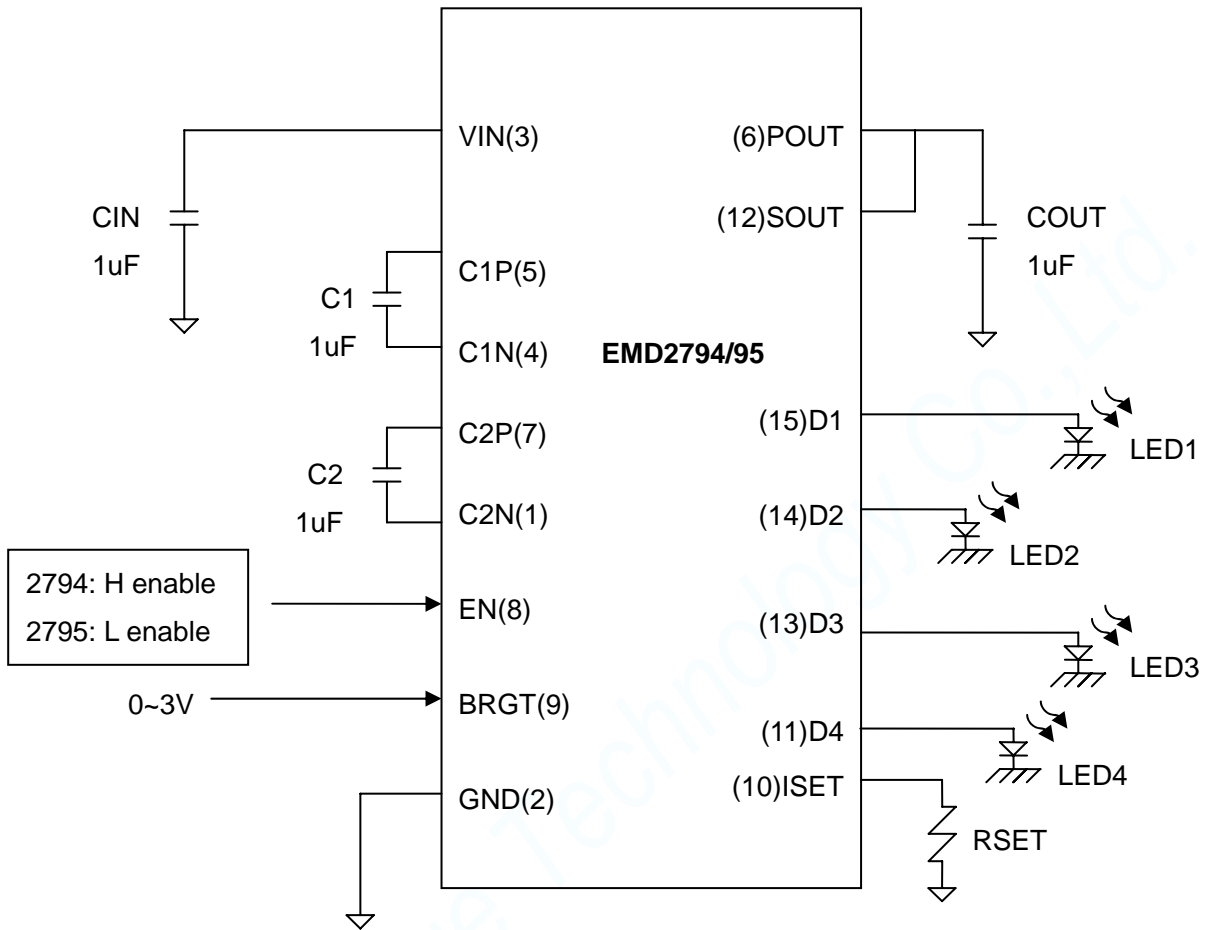

**Absolute Maximum Ratings** (Note 1)

|                                       |                                    |
|---------------------------------------|------------------------------------|
| $V_{IN}$                              | -0.5 to 6.2V                       |
| EN                                    | -0.5 to 6.2V                       |
| BRGT                                  | -0.5 to $\min[(V_{IN}+0.3), 6.2V]$ |
| Continuous Power Dissipation (Note 2) | Internally Limited                 |
| $T_{JMAX}$ (Note 2)                   | 135°C                              |
| Storage Temperature                   | -60°C to +150°C                    |
| Lead Temp. (Soldering, 5 sec.)        | 260°C                              |

## ESD Rating

|                  |      |
|------------------|------|
| Human Body Model | 2kV  |
| Machine Model    | 200V |

**Recommended Operating Conditions**

|                                |               |
|--------------------------------|---------------|
| $V_{IN}$                       | 2.7 to 5.5V   |
| Ambient Temperature ( $T_A$ )  | -30C to +85C  |
| Junction Temperature ( $T_J$ ) | -30C to +100C |

**Electrical Characteristics**

Limits in standard typeface are for  $T_J=25^\circ\text{C}$  and limits in **boldface type** apply over the full **Operating Junction Temperature Range** ( $-30^\circ\text{C} \leq T_J \leq +100^\circ\text{C}$ ). Unless otherwise specified,  $C_1=C_2=C_{IN}=C_{OUT}=1\mu\text{F}$ ,  $V_{IN}=3.6\text{V}$ , BRGT pin =0V;  $R_{SET}=124\Omega$ ; EMD2794:  $V_{EN}=V_{IN}$  (EMD2795:  $V_{EN}=0\text{V}$ ).

| Symbol        | Parameter                                | Conditions  | Min | Typ         | Max | Units            | Note |
|---------------|--|---|-----|-------------|-----|------------------|------|
| $I_{DX}$      | Available current                        | $3.0\text{V} \leq V_{IN} \leq 5.5\text{V}$<br>$V_{DX} \leq 3.8\text{V}$ , BRGT=50mV |     | 16.7        |     | mA               |      |
| $I_{D-MATCH}$ | Current Matching Between Any Two Outputs | $V_{DX}=3.6\text{V}$  |     | 0.5         |     | %                |      |
| $I_Q$         | Quiescent Supply Current                 | $3.0\text{V} \leq V_{IN} \leq 4.2\text{V}$ , Active, No Load,<br>$R_{SET}=OPEN$     |     | 3.2         |     | mA               |      |
| $I_{SD}$      | Shutdown Supply Current                  | $3.0\text{V} \leq V_{IN} \leq 5.5\text{V}$ , Shutdown                               |     |             | 1   | $\mu\text{A}$    |      |
| $I_{PULL-EN}$ | EN pull-high current (EMD2795)           |   |     | 3.2         |     | $\mu\text{A}$    |      |
| $V_{CP}$      | 1.5X to 1.0X Threshold                   |   |     | 4.75        |     | V                |      |
| $V_{CPH}$     | 1.0X to 1.5X Hysteresis                  |   |     | 300         |     | mV               |      |
| $V_{IH}$      | EN Input Logic High (EMD2794)            |   |     | 1.0         |     |                  |      |
|               | EN Input Logic High (EMD2795)            |   |     | $0.8V_{IN}$ |     |                  |      |
| $V_{IL}$      | EN Input Logic Low (EMD2794)             |   |     | 0.4         |     | V                |      |
|               | EN Input Logic Low (EMD2795)             |   |     | $0.2V_{IN}$ |     |                  |      |
| $R_{BRGT}$    | BRGT Input Resistance                    |   |     | 240         |     | $\text{k}\Omega$ |      |
| $f_{SW}$      | Switching Frequency                      | $3.0\text{V} \leq V_{IN} \leq 5.5\text{V}$  |     | 1.2         |     | MHz              |      |

**Note 1:** Absolute maximum ratings indicate limits beyond which damage to the device may occur. Electrical specifications do not apply when operating the device beyond its rated operating conditions.

**Note 2:** Internal thermal shutdown circuitry protects the device from permanent damage. Thermal shutdown engages at  $T_J=150^\circ\text{C}$  (typ.) and disengages at  $T_J=140^\circ\text{C}$  (typ.).

*Elite MicroPower Inc. reserves the right to make changes to improve reliability or manufacturability without notice, and customers are advised to obtain the latest version of relevant information prior to placing orders.*

## Pin Descriptions

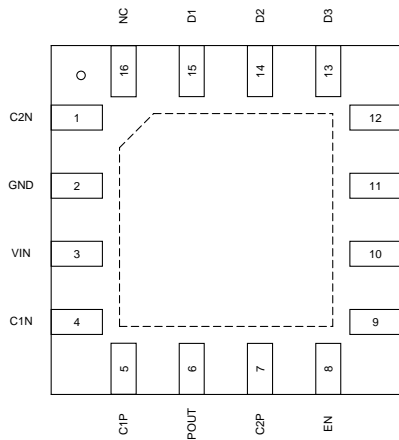

TQFN- 16 pin 3mm x 3mm, Top View

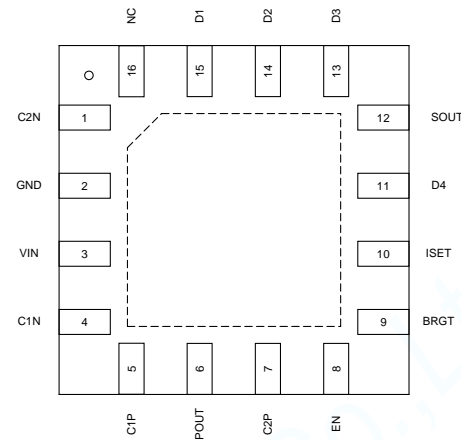

FBP-16 pin 3mm x 3mm, Top View

| Pin Name | Pin Order | Descriptions   |
|----------|-----------|--|
| C2N      | 1         | Negative terminal of C2  |
| GND      | 2         | Power supply ground input  |
| VIN      | 3         | Power supply voltage input   |
| C1N      | 4         | Negative terminal of C1  |
| C1P      | 5         | Positive terminal of C1  |
| POUT     | 6         | Charge pump output. Connect 1uF ceramic capacitor at this pin.   |
| C2P      | 7         | Positive terminal of C2  |
| EN       | 8         | The EMD2794 has an active-low shutdown pin (LOW = shutdown, HIGH = operating). The EMD2795 has an active-high shutdown pin (HIGH = shutdown, LOW = operating) that has a pull-up to $V_{IN}$ . |
| BRGT     | 9         | Variable voltage input controls output current   |
| ISET     | 10        | Current Sense Input. Connect 1% resistor to ground to set constant current through LED.  |
| D4       | 11        | Current source outputs. Connect directly to LED.   |
| SOUT     | 12        | Charge pump input. Connect directly to pin POUT. (Please refer to typical application.)  |
| D3       | 13        | Current source outputs. Connect directly to LED.   |
| D2       | 14        | Current source outputs. Connect directly to LED.   |
| D1       | 15        | Current source outputs. Connect directly to LED.   |
| NC       | 16        |  |
| EP       | EP        | Exposed paddle (bottom); connect to GND directly beneath package.  |

## Typical Performance Characteristics

Unless otherwise specified, C1=C2=CIN=COU, VIN=3.6V, BRGT=0V, RSET=124Ω

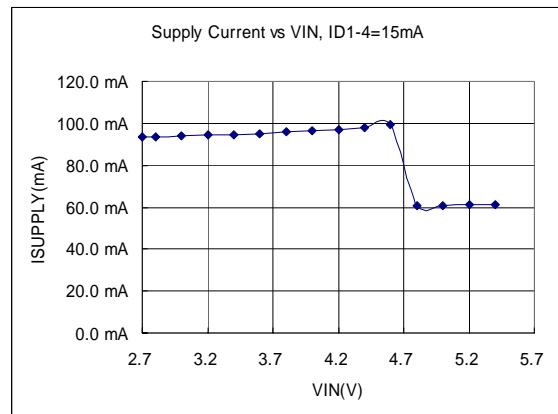
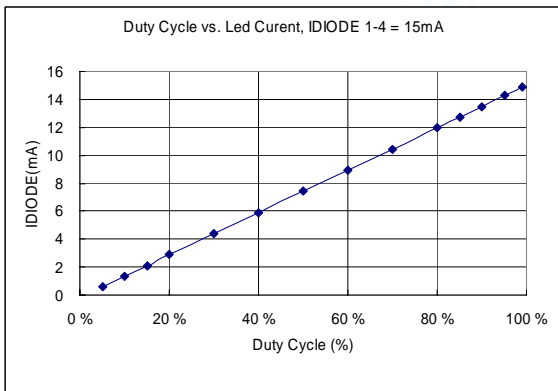
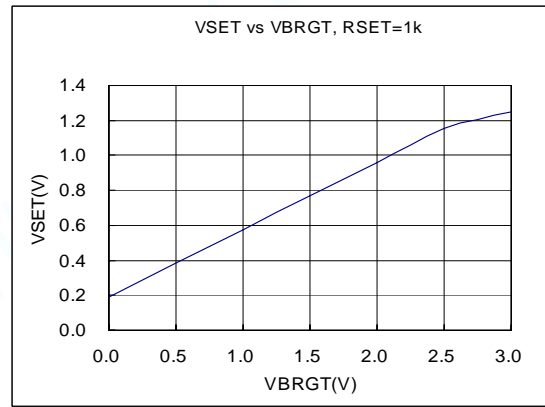
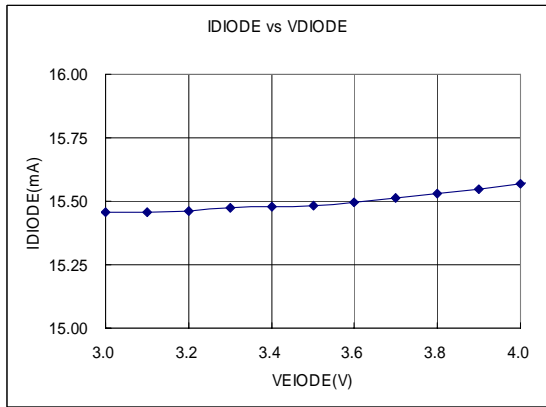
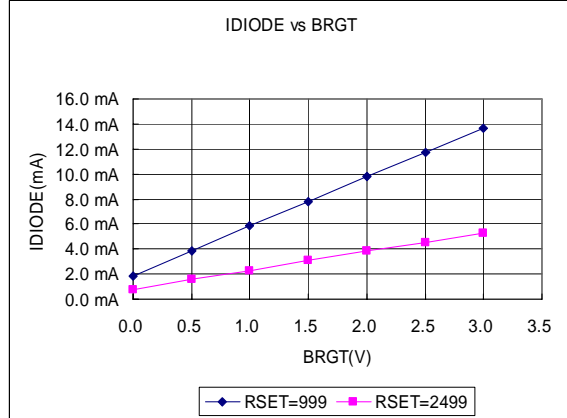
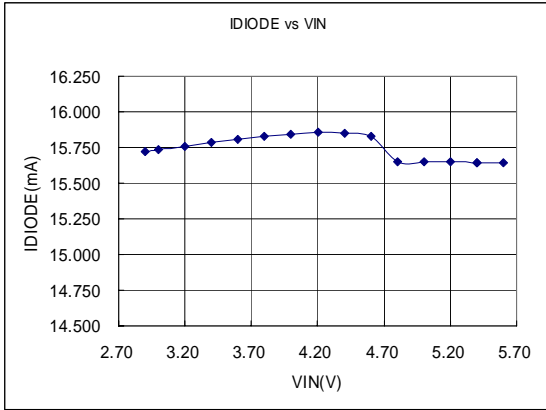

## Typical Performance Characteristics

Unless otherwise specified, C1=C2=CIN=COU, VIN=3.6V, BRGT=0V, RSET=124Ω

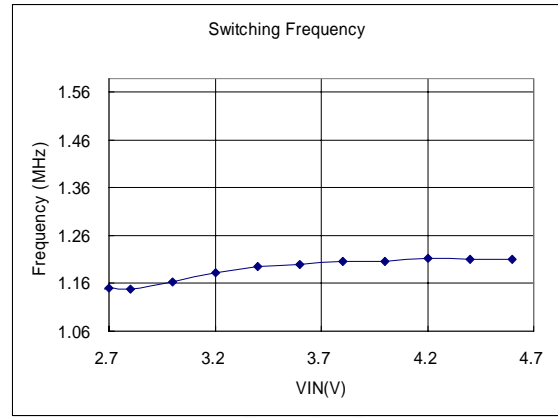
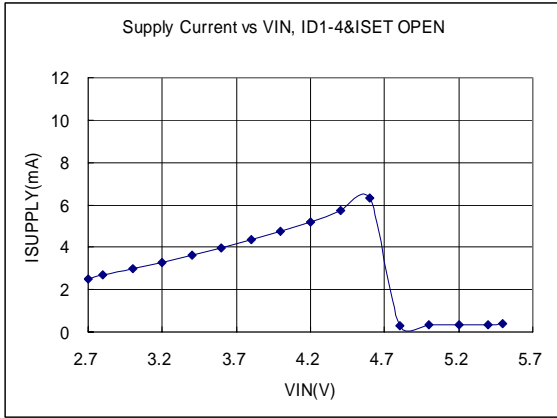



## Function Block Diagram

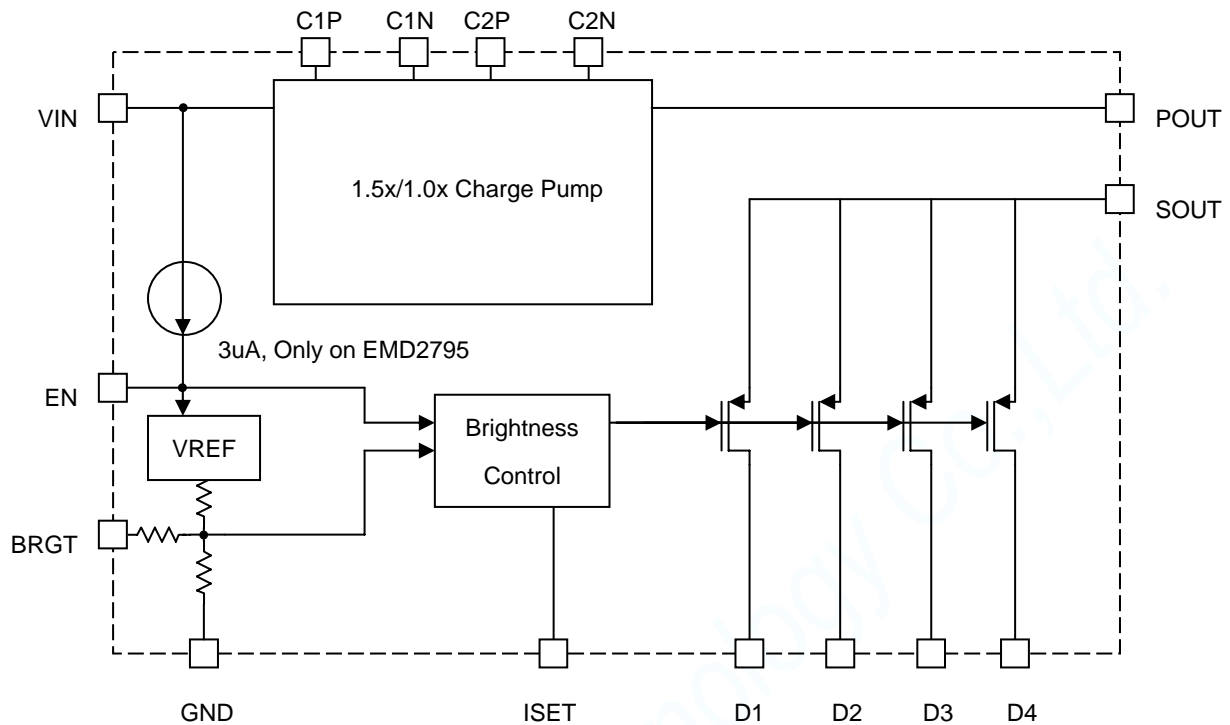

## Application Information

### CIRCUIT DESCRIPTION

The EMD2794/5 is a 1.5x/1.0x charge pump with four matched constant current outputs, each capable of driving up to 20mA. This device operates over the extended Li-Ion battery range from 2.7V to 5.5V. At input voltages below 4.75V (typ.), the charge-pump provides the needed voltage to drive high forward voltage drop LEDs by stepping up the POUT voltage 1.5 times the input voltage. The charge pump provides a voltage on POUT equal to the input voltage when the input voltage is at or above 4.75V (typ.). The EMD2794/5 can drive up to 80mA through any combination of LEDs connected to the constant current outputs D1-D4.

The EMD2794/5 uses a resistor connected to the ISET pin to set a reference current. This reference current is then multiplied 10 times to each constant current output.

The LED brightness can then be controlled by analog and/or digital methods. Applying an analog voltage in the

range of 0V to 3.0V to the Brightness pin (BRGT) adjusts the dimming profile of the LEDs. The digital technique uses a PWM (Pulse Width Modulation) signal applied to the Enable pin (EN).

### SOFT START

Soft start is implemented internally by ramping the reference voltage more slowly than the applied voltage. During soft start, the current through the LED outputs will ramp up in proportion to the rate that the reference voltage is being ramped up.

### SHUTDOWN MODE

The enable pin (EN) disables the device and reduces the quiescent current to below than 1uA. The EMD2795 has an active-low enable pin (HIGH = shutdown, LOW = operating). An internal pull-up is connected between EN and VIN of the EMD2795. This allows the use of open-drain logic control of the EMD2795 shutdown. The EMD2795 EN

*Elite MicroPower Inc. reserves the right to make changes to improve reliability or manufacturability without notice, and customers are advised to obtain the latest version of relevant information prior to placing orders.*

pin can also be driven with a rail-to-rail CMOS logic signal.

The EMD2794 has an active-high enable pin (LOW = shutdown, HIGH = operating). The EMD2794 EN pin can be driven with a low-voltage CMOS logic signal (1.5V logic, 1.8V logic, etc). There is no internal pull-up or pull-down on the EN pin of the EMD2794.

## CAPACITOR SELECTION

The EMD2794/5 requires 4 external capacitors for proper operation. Surface-mount multi-layer ceramic capacitors are recommended. These capacitors are small, inexpensive and have very low equivalent series resistance (ESR,  $\leq 15\text{m}\Omega$  typ.).

For most applications, ceramic capacitors with X7R or X5R temperature characteristic are preferred for use with the EMD2794/5. These capacitors have tight capacitance tolerance (as good as  $\pm 10\%$ ), hold their value over temperature (X7R:  $\pm 15\%$  over  $-55^\circ\text{C}$  to  $125^\circ\text{C}$ ; X5R:  $\pm 15\%$  over  $-55^\circ\text{C}$  to  $85^\circ\text{C}$ ), and typically have little voltage coefficient. Capacitors with Y5V or Z5U temperature characteristic are generally not recommended for use with the EMD2794/5.

## LED SELECTION

The EMD2794/5 is designed to drive LEDs with a forward voltage of about 3.0V to 4.0V. The typical and maximum diode forward voltage depends highly on the manufacturer and their technology. Forward current matching is assured over the LED process variations due to the constant current output of the EMD2794/5.

## I<sub>SET</sub> AND BRGT PINS

An external resistor, RSET, is connected to the ISET pin to set the current to be mirrored in each of the LED outputs. The internal current mirror sets each LED output current with a 10:1 ratio to the current through RSET. The current mirror circuitry matches the current through each LED to within

0.5%.

In addition to RSET, a voltage may be applied to the VBRGT pin to vary the LED current. By adjusting current with the Brightness pin (BRGT), the brightness of the LEDs can be smoothly varied. Applying a voltage on BRGT between 0 to 3 volts will linearly vary the LED current. An equation for approximating the LED current is:

$$I_{LED} = (0.188 + 0.385 * V_{BRGT}) / R_{SET} * 10 \text{ Amps}$$

## I<sub>LED</sub> CURRENT SELECTION PROCEDURES

The following procedures illustrate how to set and adjust output current levels. For constant brightness or analog brightness control, go to "Brightness control using BRGT". Otherwise refer to "Brightness control using PWM".

### Brightness Control Using PWM

1. Set the BRGT pin to 0V.
2. Determine the maximum desired ILED current. Use the ILED equation to calculate RSET by setting BRGT to 0V or use Table 1 to select a value for RSET when BRGT equals 0V.
3. Brightness control can be implemented by pulsing a signal at the EN pin. LED brightness is proportional to the duty cycle (D) of the PWM signal. For linear brightness control over the full duty cycle adjustment range, the PWM frequency (f) should be limited to accommodate the turn-on time (TON = 100 $\mu$ s) of the device.

$$D \times (1/f) > TON$$

$$f_{MAX} = D_{MIN} \div TON$$

If the PWM frequency is much less than 100Hz, flicker may be seen in the LEDs. For the EMD2794, zero duty cycle will turn off the LEDs and a 50% duty cycle will result in an average ILED being half of the programmed LED current. For example, if RSET is set to program 15mA, a 50% duty cycle will result in an average ILED of 7.5mA. For the EMD2795 however,

*Elite MicroPower Inc. reserves the right to make changes to improve reliability or manufacturability without notice, and customers are advised to obtain the latest version of relevant information prior to placing orders.*

100% duty cycle will turn off the LEDs and a 50% duty cycle will result in an average ILED being half the programmed LED current.

Table 1 R<sub>SET</sub> Values

| BRGT | LED Current |        |      |      |
|------|-------------|--------|------|------|
|      | 5mA         | 10mA   | 15mA | 20mA |
| 0.0V | 376Ω        | 188Ω   | 125Ω | 94Ω  |
| 0.5V | 761Ω        | 381Ω   | 254Ω | 190Ω |
| 1.0V | 1.15kΩ      | 573Ω   | 382Ω | 287Ω |
| 1.5V | 1.53kΩ      | 766Ω   | 510Ω | 383Ω |
| 2.0V | 1.92kΩ      | 958Ω   | 639Ω | 479Ω |
| 2.5V | 2.30kΩ      | 1.15kΩ | 767Ω | 575Ω |
| 3.0V | 2.69kΩ      | 1.34kΩ | 895Ω | 672Ω |

### Brightness Control Using BRGT

1. Choose the maximum ILED desired and determine the max voltage to be applied to the BRGT pin. For constant brightness, set BRGT to a fixed voltage between 0V to 3V.
2. Use the ILED equation above to calculate RSET.
3. Use Table 2 as a reference for the dimming profile of the LEDs, when BRGT ranges from 0V to 3V.

Table 2 LED Current

| BRGT | LED Current |        |        |        |
|------|-------------|--------|--------|--------|
|      | 2.67kΩ      | 1.33kΩ | 909Ω   | 665Ω   |
| 0.0V | 0.7mA       | 1.4mA  | 2.1mA  | 2.8mA  |
| 0.5V | 1.4mA       | 2.9mA  | 4.2mA  | 5.7mA  |
| 1.0V | 2.1mA       | 4.3mA  | 6.3mA  | 8.6mA  |
| 1.5V | 2.9mA       | 5.8mA  | 8.4mA  | 11.5mA |
| 2.0V | 3.6mA       | 7.2mA  | 10.5mA | 14.4mA |
| 2.5V | 4.3mA       | 8.7mA  | 12.7mA | 17.3mA |
| 3.0V | 5.0mA       | 10.1mA | 14.8mA | 20.2mA |

### CHARGE PUMP OUTPUT AND INPUT (P<sub>OUT</sub> AND S<sub>OUT</sub>)

The EMD2794/5 charge pump is an unregulated switched capacitor converter with a gain of 1.5. The voltage at the output of the pump (the POUT pin) is nominally 1.5 x VIN. This rail can be used to deliver additional current to other circuitry. Since POUT is unregulated, driving LEDs directly off POUT is usually practical only with a fixed input voltage. If the input voltage is not fixed (Li-Ion battery, for example), using a linear regulator between the POUT pin and the LEDs is recommended.

LED drivers use power supply from pin SOUT. To maintain normal operation of LED current output, connect pin SOUT directly to POUT on PCB.

### PARALLEL DX OUTPUTS FOR INCREASED CURRENT DRIVE

Outputs D1 through D4 may be connected together in any combination to drive higher currents through fewer LEDs. For example, outputs D1 and D2 can be connected together to drive one LED while D3 and D4 are connected together to drive a second LED.

### THERMAL PROTECTION

When the junction temperature exceeds 150°C (typ.), the EMD2794/5 internal thermal protection circuitry disables the part. This feature protects the device from damage due to excessive power dissipation. The device will recover and operate normally when the junction temperature falls below 140°C (typ.). It is important to have good thermal conduction with a proper layout to reduce thermal resistance.

## Package Description

### TQFN-16

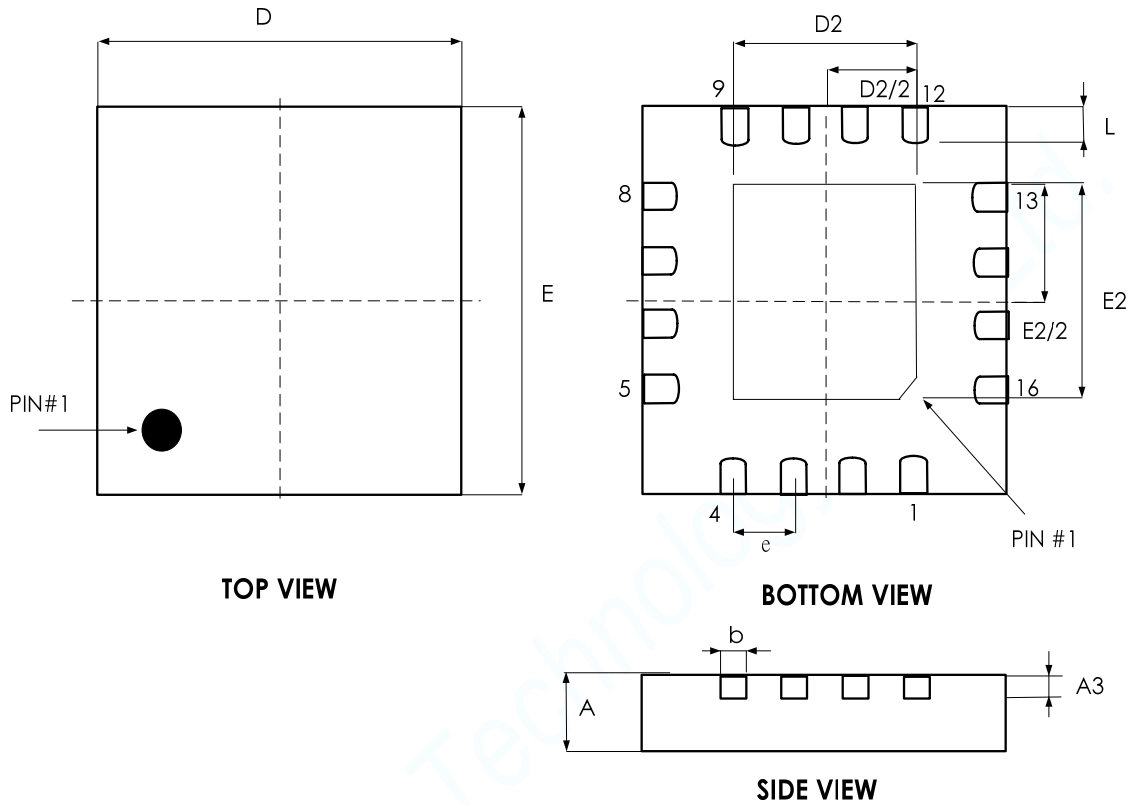

| SYMBOL | COMMON                |       |       |                 |        |        |
|--------|-----------------------|-------|-------|-----------------|--------|--------|
|        | DIMENSIONS MILLIMETER |       |       | DIMENSIONS INCH |        |        |
|        | MIN.                  | NOM.  | MAX.  | MIN.            | NOM.   | MAX.   |
| A      | 0.700                 | 0.750 | 0.800 | 0.027           | 0.029  | 0.031  |
| A3     | 0.195                 | 0.203 | 0.211 | 0.0077          | 0.0080 | 0.0083 |
| b      | 0.180                 | 0.230 | 0.300 | 0.007           | 0.009  | 0.012  |
| D      | 2.950                 | 3.000 | 3.050 | 0.116           | 0.118  | 0.120  |
| E      | 2.950                 | 3.000 | 3.050 | 0.116           | 0.118  | 0.120  |
| e      | 0.50 BSC              |       |       | 0.020 BSC       |        |        |
| L      | 0.350                 | 0.400 | 0.450 | 0.014           | 0.016  | 0.018  |
| D2     | 1.500                 | 1.625 | 1.750 | 0.059           | 0.064  | 0.069  |
| E2     | 1.500                 | 1.625 | 1.750 | 0.059           | 0.064  | 0.069  |

*Elite MicroPower Inc. reserves the right to make changes to improve reliability or manufacturability without notice, and customers are advised to obtain the latest version of relevant information prior to placing orders.*

## FBP-16

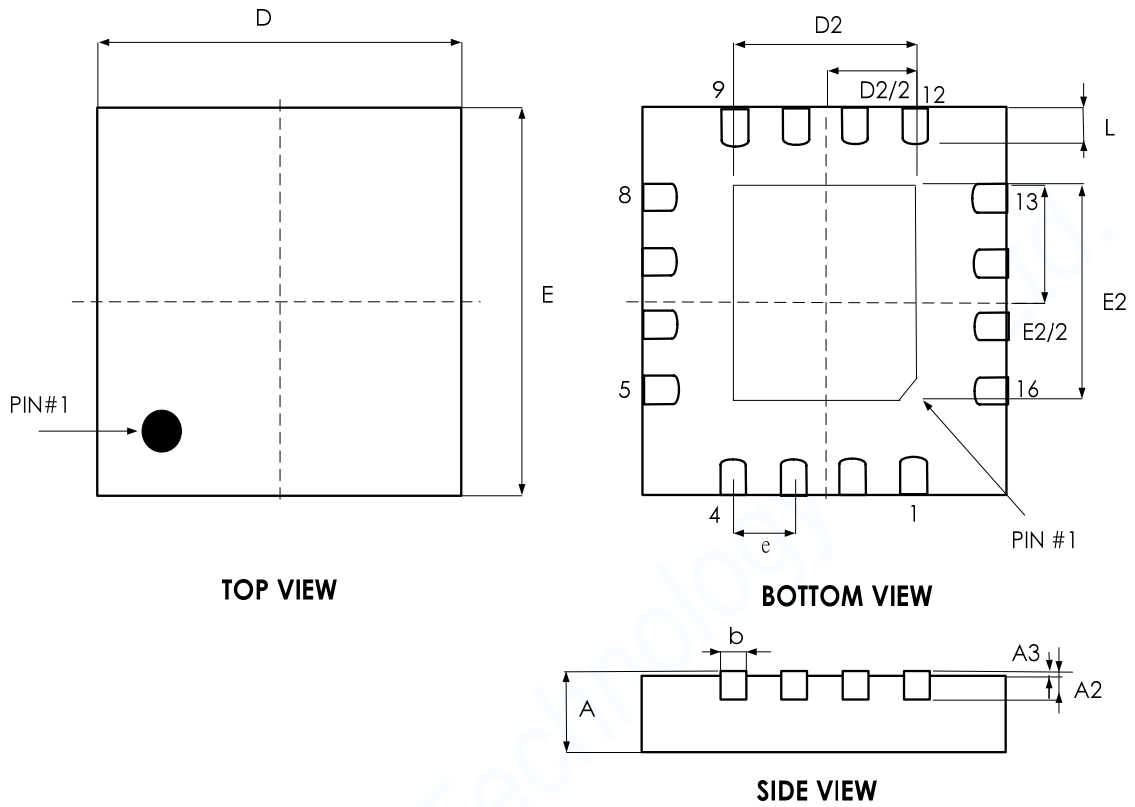

| SYMBOL | DIMENSIONS MILLIMETER |       |       |
|--------|-----------------------|-------|-------|
|        | MIN.                  | NOM.  | MAX.  |
| A      | 0.800                 | 0.850 | 0.900 |
| A2     | 0.153                 | 0.203 | 0.253 |
| A3     | 0.000                 | 0.025 | 0.050 |
| b      | 0.180                 | 0.230 | 0.300 |
| D      | 2.900                 | 3.000 | 3.100 |
| E      | 2.900                 | 3.000 | 3.100 |
| e      | 0.500 BSC             |       |       |
| L      | 0.300                 | 0.400 | 0.500 |
| D2     | 1.600                 | 1.700 | 1.800 |
| E2     | 1.600                 | 1.700 | 1.800 |

*Elite MicroPower Inc. reserves the right to make changes to improve reliability or manufacturability without notice, and customers are advised to obtain the latest version of relevant information prior to placing orders.*



Elite MicroPower Inc.

# Preliminary EMD2794/EMD2795

© Copyright 2005 All rights reserved.

No part of this document may be reproduced or duplicated in any form or by any means without the prior permission of EMP.

The contents contained in this document are believed to be accurate at the time of publication. EMP assumes no responsibility for any error in this document, and reserves the right to change the products or specification in this document without notice.

The information contained herein is presented only as a guide or examples for the application of our products. No responsibility is assumed by EMP for any infringement of patents, copyrights, or other intellectual property rights of third parties which may result from its use. No license, either express, implied or otherwise, is granted under any patents, copyrights or other intellectual property rights of EMP or others.

Any semiconductor devices may have inherently a certain rate of failure. To minimize risks associated with customer's application, adequate design and operating safeguards against injury, damage, or loss from such failure, should be provided by the customer when making application designs.

EMP's products are not authorized for use in critical applications such as, but not limited to, life support devices or system, where failure or abnormal operation may directly affect human lives or cause physical injury or property damage. If products described here are to be used for such kinds of application, purchaser must do its own quality assurance testing appropriate to such applications.

*Elite MicroPower Inc. reserves the right to make changes to improve reliability or manufacturability without notice, and customers are advised to obtain the latest version of relevant information prior to placing orders.*