

Fast Ultra High-PSRR, Low-Noise 300mA CMOS LDO in SOT-23 Package

General Description

The EMP8733 features ultra-high power supply rejection ratio, low output voltage noise, low dropout voltage, low quiescent current and fast transient response. It guarantees delivery of 300mA output current and supports preset output voltages ranging from 0.8V to 4.5V with 0.05V increment.

Based on its low quiescent current consumption, the EMP8733 is ideal for battery-powered applications. The high power supply rejection ratio of the EMP8733 holds well for low input voltages typically encountered in battery-operated systems. The regulator is stable with small ceramic capacitive loads (1 μ F typical). The EMP8733 is Available in miniature 3-pin SOT-23-3 package.

EMP products are Halogen free and RoHS compliant.

Features

- 300mA guaranteed output current
- 62dB typical PSRR at 1kHz
- 110 μ V RMS output voltage noise (10Hz to 100kHz)
- 290mV typical dropout at 300mA
- 57 μ A typical quiescent current
- Fast line and load transient response
- 2.2V to 5.5V input range
- Stable with small ceramic output capacitors
- Over temperature and over current protection
- \pm 2% output voltage tolerance

Applications

- Wireless handsets
- PCMCIA cards
- DSP core power
- Hand-held instruments
- Battery-powered systems
- Portable information appliances

Typical Application

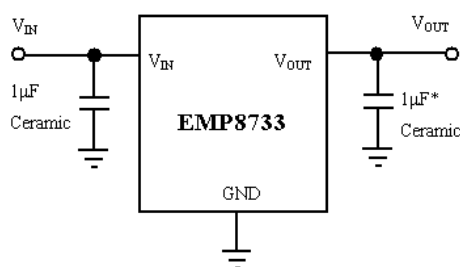

*Use 2.2 μ F for $V_{OUT} < 1.2\text{V}$

CONNECTION DIAGRAM SOT-23-3(TOP View)

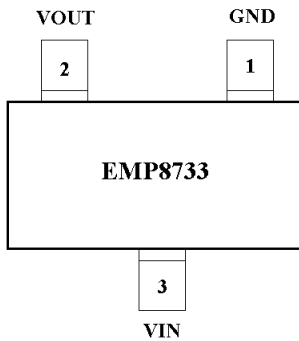

ORDER INFORMATION

EMP8733-XXVB03GRR

- XX Output voltag
- VB03 SOT-23-3 Package
- GRR RoHS & Halogen free
- Rating: -40 to 85°C
- Package in Tape & Reel

Pin Functions

Name	No.	Function
GND	1	Ground Pin.
VOUT	2	Output Voltage Feedback.
VIN	3	Supply Voltage Input. Require a minimum input capacitor of close to 1μF to ensure stability and sufficient decoupling from the ground pin.

Order, Mark & Packing Information

Vout	Marking	Product ID	Packing
1.2		EMP8733-12VB03GRR	3K units Tape & Reel
1.5		EMP8733-15VB03GRR	3K units Tape & Reel
1.8		EMP8733-18VB03GRR	3K units Tape & Reel
2.5		EMP8733-25VB03GRR	3K units Tape & Reel
2.8		EMP8733-28VB03GRR	3K units Tape & Reel
3.0		EMP8733-30VB03GRR	3K units Tape & Reel
3.3		EMP8733-33VB03GRR	3K units Tape & Reel

Functional Block Diagram

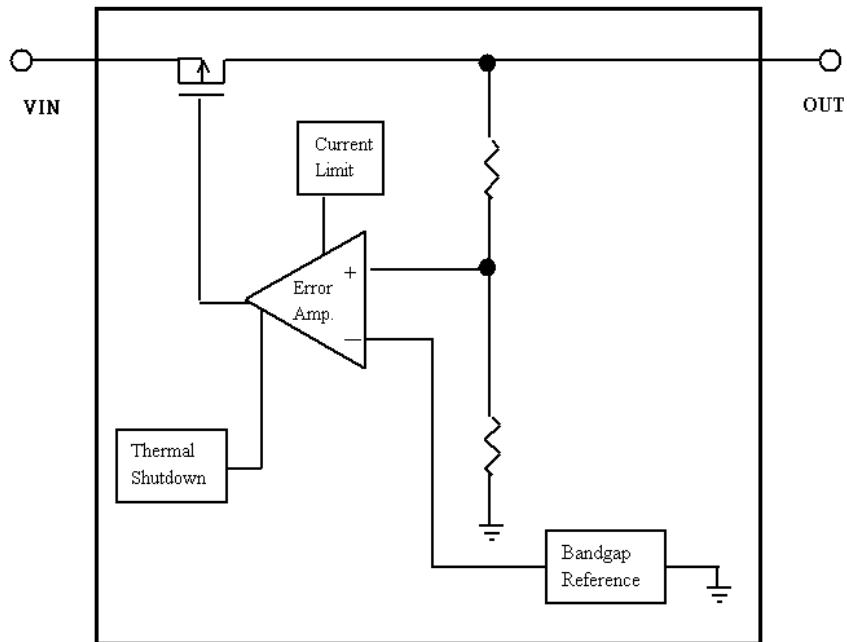

Absolute Maximum Ratings (Notes 1, 2)

V _{IN} , V _{OUT}	-0.3V to 6.5V	Thermal Resistance (θ _{JA})	
Storage Temperature Range	-65°C to 160°C	3-pin SOT-23-3	250°C/W
Junction Temperature (T _J)	150°C		
Lead Temperature (10 sec.)	240°C	Operating Ratings (Note 1, 2)	
ESD Rating		Temperature Range	-40°C to 85°C
Human Body Model	2kV	Supply Voltage	2.2V to 5.5V
MM	200V		

Electrical Characteristics

Unless otherwise specified, all limits guaranteed for V_{IN} = V_{OUT} + 1V (Note 3), C_{IN} = C_{OUT} = 2.2μF, T_A = 25°C. **Boldface** limits apply for the operating temperature extremes: -40°C and 85°C.

Symbol	Parameter	Conditions	Min	Typ	Max	Units
V _{IN}	Input Voltage		2.2		5.5	V
V _{OUT}	Output Voltage		0.8		4.5	V
ΔV _{OTL}	Output Voltage Tolerance	1mA ≤ I _{OUT} ≤ 300mA V _{OUT (NOM)} + 1V ≤ V _{IN} ≤ 5.5V (Note 3)	-2		+2	% of V _{OUT (NOM)}
I _{OUT}	Maximum Output Current	Average DC Current Rating	300			mA
I _{LIMIT}	Output Current Limit		300	450		mA
I _Q	Supply Current	I _{OUT} = 0mA		57		μA
		I _{OUT} = 300mA		130		
V _{DO}	Dropout Voltage (Note 4)	I _{OUT} = 100mA		90		mV
		I _{OUT} = 300mA		290		
ΔV _{OUT}	Line Regulation	I _{OUT} = 1mA, (V _{OUT} + 1V) ≤ V _{IN} ≤ 5.5V (Note 3)	-0.1	0.01	0.1	%/V
	Load Regulation	1mA ≤ I _{OUT} ≤ 300mA		0.0008		%/mA
e _n	Output Voltage Noise	V _{OUT} = 2.5V, I _{OUT} = 10mA, 10Hz ≤ f ≤ 100kHz		110		μV _{RMS}
T _{SD}	Thermal Shutdown Temperature			165		°C
	Thermal Shutdown Hysteresis			35		

Note 1: Absolute Maximum ratings indicate limits beyond which damage may occur. Electrical specifications do not apply when operating the device outside of its rated operating conditions.

Note 2: All voltages are with respect to the potential at the ground pin.

Note 3: Condition does not apply to input voltages below 2.2V since this is the minimum input operating voltage.

Note 4: Dropout voltage is measured by reducing V_{IN} until V_{OUT} drops 100mV from its nominal value at V_{IN} - V_{OUT} = 1V. Dropout voltage does not apply to the regulator versions with V_{OUT} less than 2.2V.

Typical Performance Characteristics

Unless otherwise specified, $V_{IN} = V_{OUT(NOM)} + 1V$, $C_{IN} = C_{OUT} = 1.0\mu F$, $T_A = 25^\circ C$.

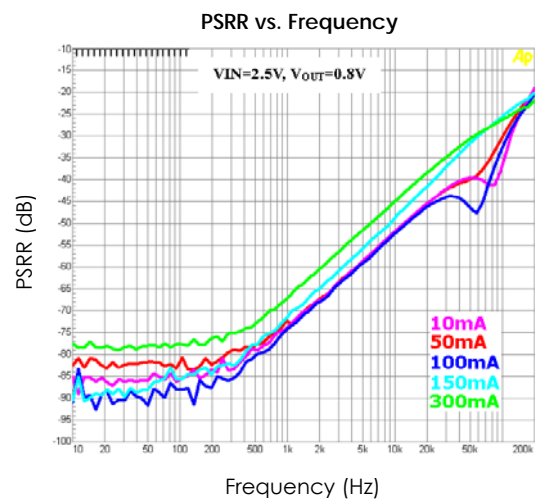
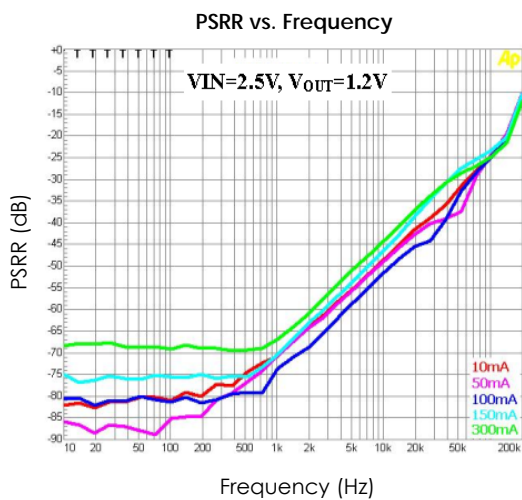
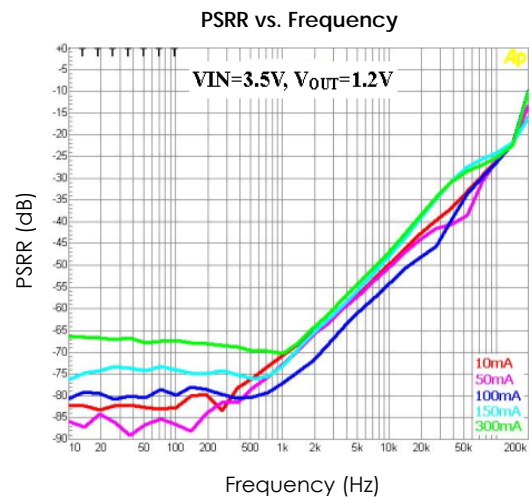
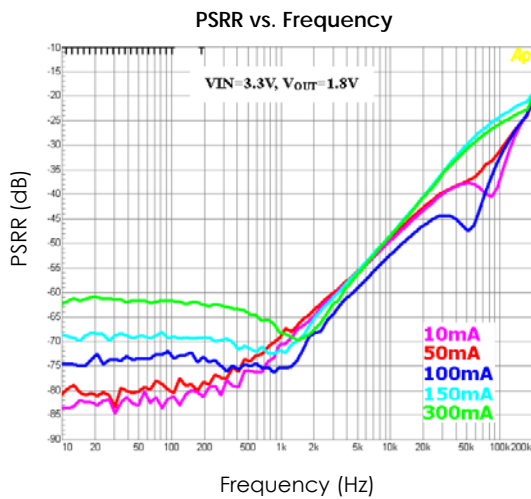
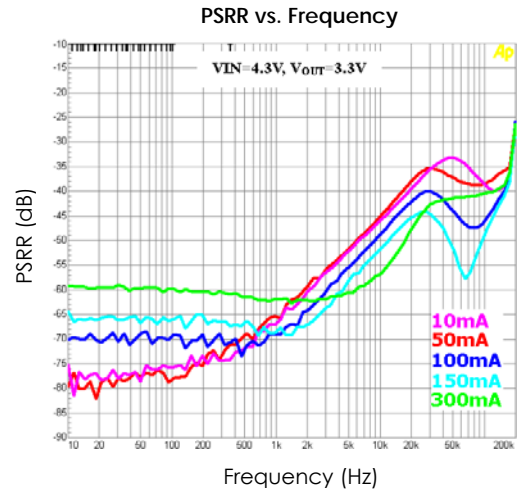
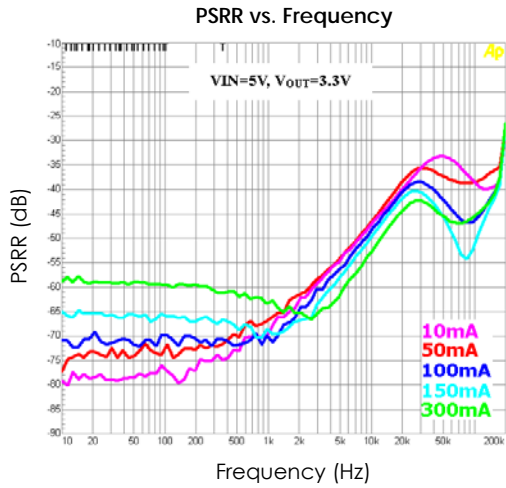

Typical Performance Characteristics

Unless otherwise specified, $V_{IN} = V_{OUT(NOM)} + 1V$, $C_{IN} = C_{OUT} = 2.2\mu F$, $T_A = 25^\circ C$. (Continued)

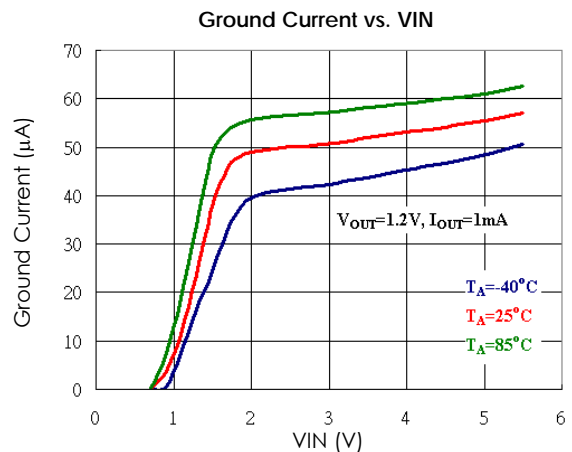
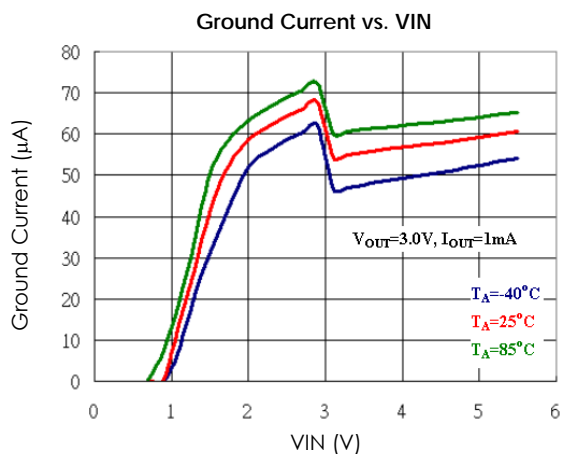
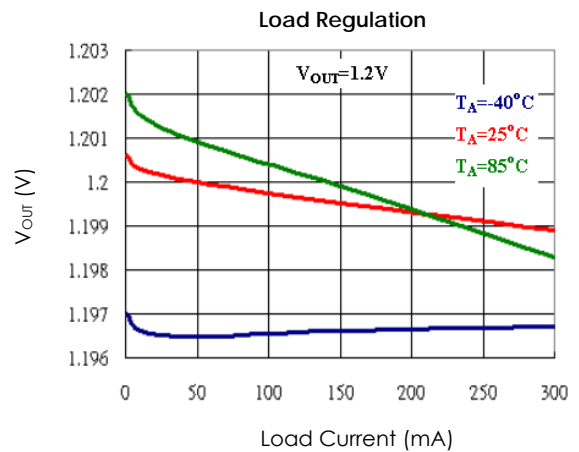
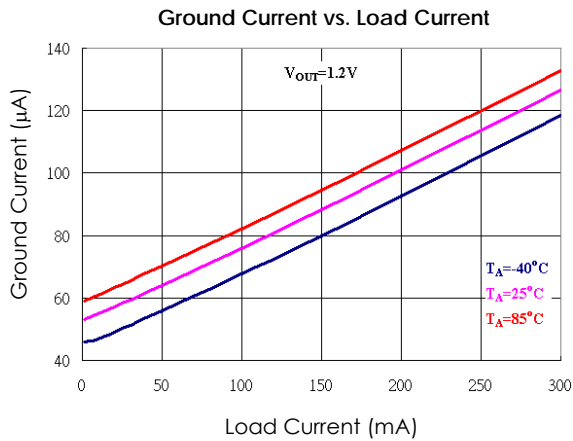
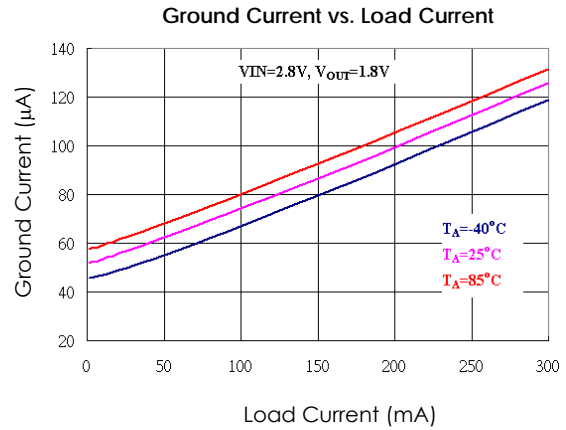
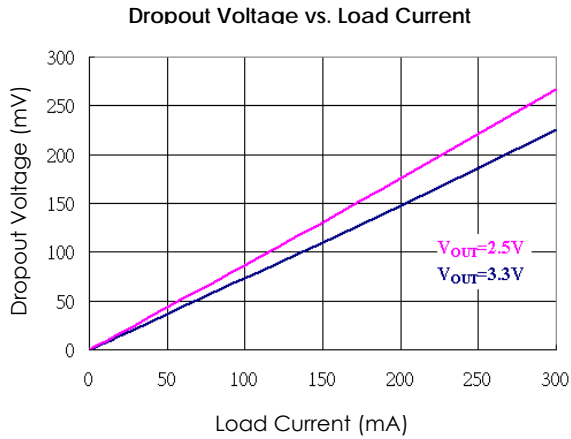

Typical Performance Characteristics

Unless otherwise specified, $V_{IN} = V_{OUT(NOM)} + 1V$, $C_{IN} = C_{OUT} = 2.2\mu F$, $T_A = 25^\circ C$. (Continued)

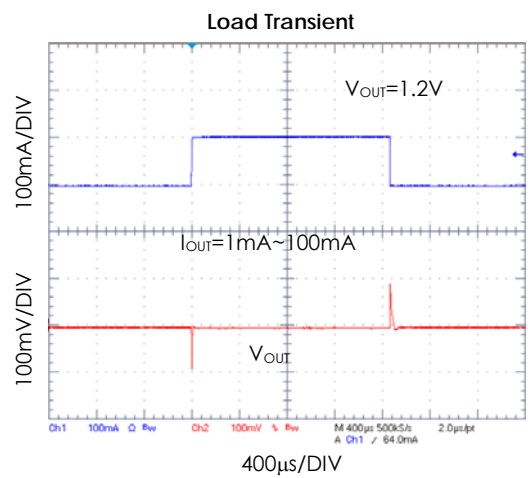
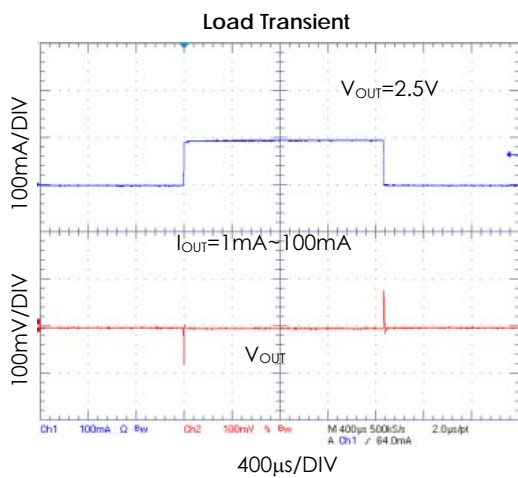
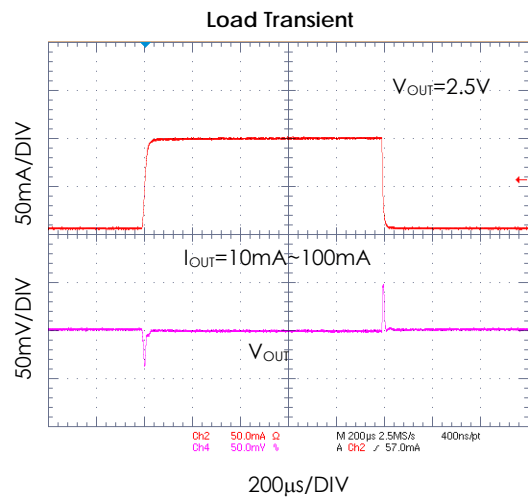
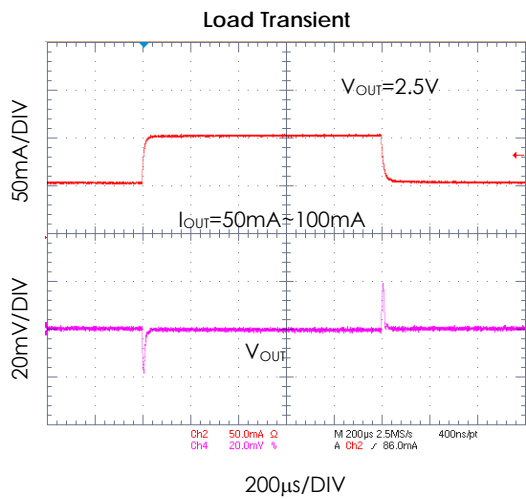
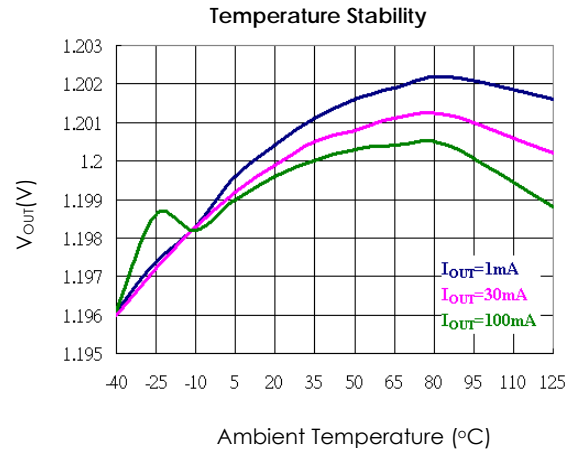
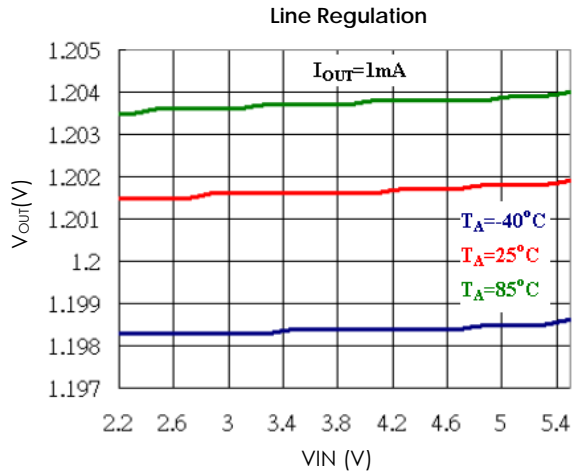

Typical Performance Characteristics

Unless otherwise specified, $V_{IN} = V_{OUT(NOM)} + 1V$, $C_{IN} = C_{OUT} = 2.2\mu F$, $T_A = 25^\circ C$. (Continued)

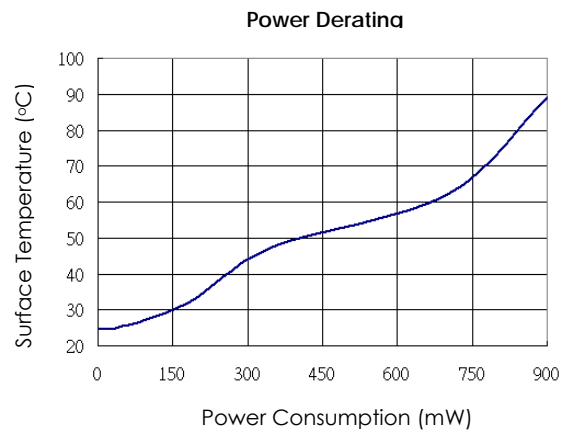
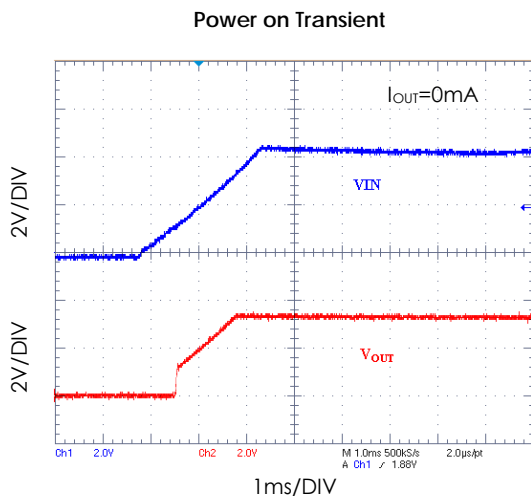
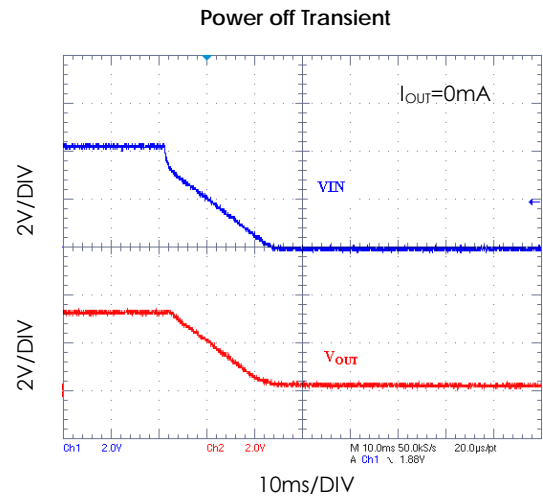
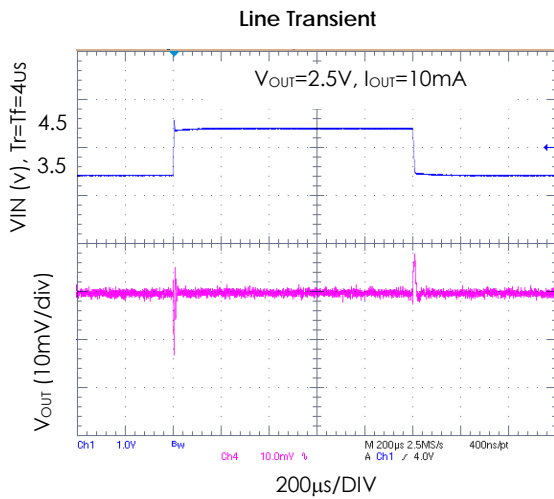
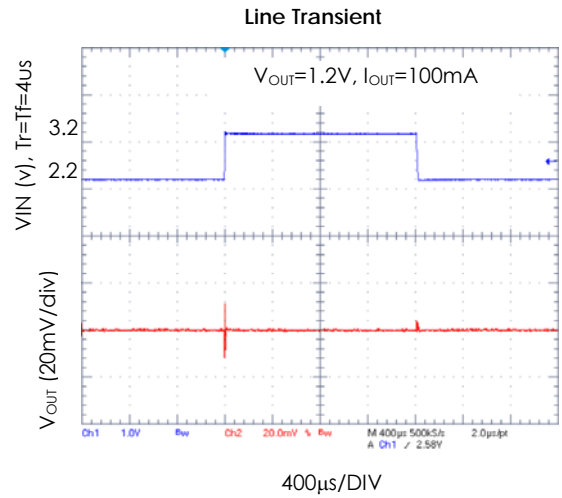
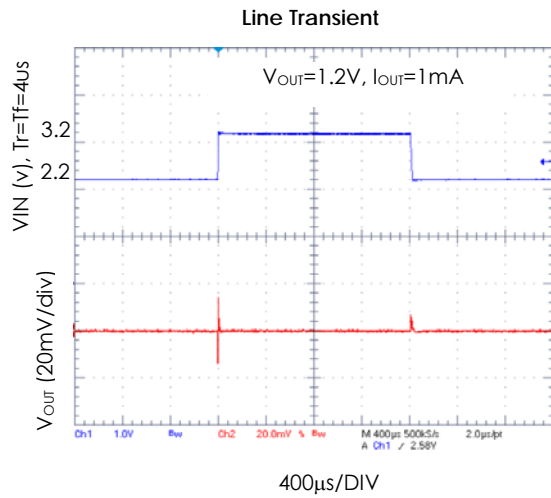

SOT-23-3

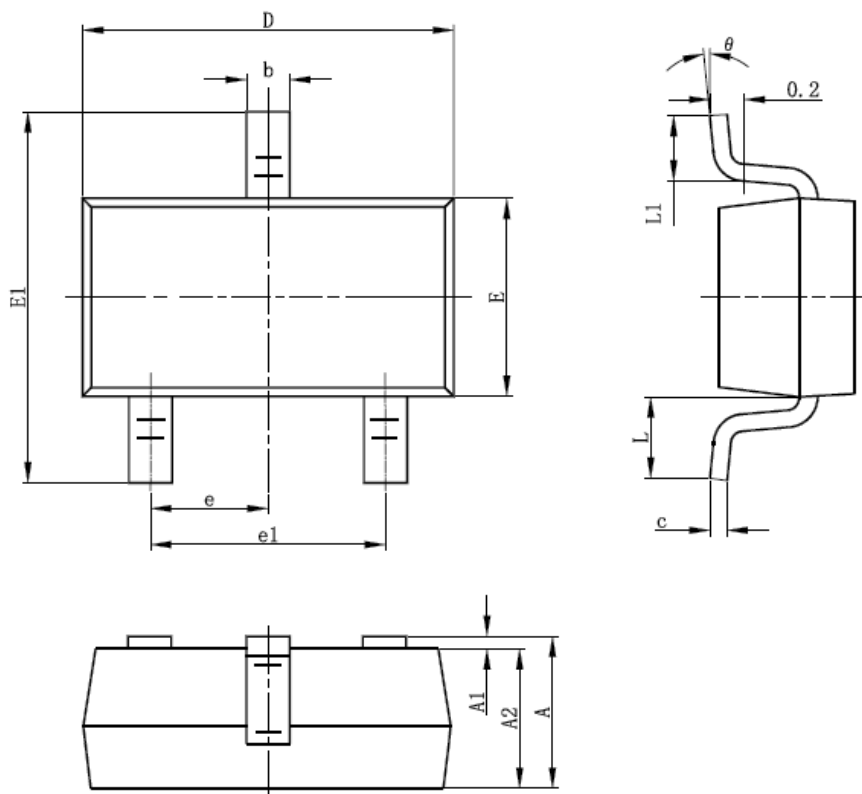

Symbol	Dimensions Millimeters		Dimensions Inches	
	Min	Max	Min	Max
A	1.000	1.400	0.039	0.055
A1	0.000	0.150	0.000	0.006
A2	0.900	1.250	0.035	0.049
b	0.250	0.500	0.010	0.020
c	0.080	0.220	0.003	0.009
D	2.750	3.050	0.108	0.120
E	1.500	1.700	0.059	0.067
E1	2.600	3.000	0.102	0.118
e	0.950TYP		0.037TYP	
e1	1.800	2.000	0.071	0.079
L	0.700REF		0.028REF	
L1	0.300	0.600	0.012	0.024
θ	0°	8°	0°	8°

Revision History

Revision	Date	Description
2.0	2009.04.03	1.Title 2.Ending 3.Order information 4.Add Revision History Form 5. Important Notice.
2.1	2009.12.17	General description→ Halogen free (page 1) GRR definition correction (page 2)
2.2	2010.09.10	Change package dimensions (page 9).

Important Notice

All rights reserved.

No part of this document may be reproduced or duplicated in any form or by any means without the prior permission of ESMT.

The contents contained in this document are believed to be accurate at the time of publication. ESMT assumes no responsibility for any error in this document, and reserves the right to change the products or specification in this document without notice.

The information contained herein is presented only as a guide or examples for the application of our products. No responsibility is assumed by ESMT for any infringement of patents, copyrights, or other intellectual property rights of third parties which may result from its use. No license, either express, implied or otherwise, is granted under any patents, copyrights or other intellectual property rights of ESMT or others.

Any semiconductor devices may have inherently a certain rate of failure. To minimize risks associated with customer's application, adequate design and operating safeguards against injury, damage, or loss from such failure, should be provided by the customer when making application designs.

ESMT's products are not authorized for use in critical applications such as, but not limited to, life support devices or system, where failure or abnormal operation may directly affect human lives or cause physical injury or property damage. If products described here are to be used for such kinds of application, purchaser must do its own quality assurance testing appropriate to such applications.