

Fast Ultra High-PSRR, Low-Noise, Low-Dropout, 150mA Micropower CMOS Linear Regulator

General Description

The EMP891X series is a family of CMOS linear regulators, which include EMP8915 and EMP8916, featuring ultra-high power supply rejection ratio, low output voltage noise, low dropout voltage, low quiescent current and fast transient response. EMP891X guarantees delivery of 150mA output current, and supports preset 1.2V, 1.3V, 1.5V, 1.8V, 2.5V, 2.8V, 2.85V output voltage versions.

Based on its low quiescent current consumption and its less than 1 μ A shutdown mode of logical operation, the EMP891X series are ideal for battery-powered applications. The ground current increases only slightly in dropout, further prolonging the battery life.

EMP891X series provide fast turn-on by using dedicated circuitry to pre-charge an optional external bypass capacitor. This bypass capacitor is used to reduce the output voltage noise without adversely affecting the load transient response. The high power supply rejection ratio of the EMP891X holds well for low input voltages typically encountered in battery-operated systems. The regulator is stable with small ceramic capacitive loads (2.2 μ F typical).

Additional features include regulation fault detection, bandgap voltage reference, constant current limiting and thermal overload protection. Available in miniature

SOT-25, SOT-26 and TDFN-6 packages, the EMP891X series are suitable for portable appliances.

EMP products is RoHS compliant.

Features

- Miniature SOT-25, SOT-26 and TDFN-6 packages
- 150mA guaranteed output current
- 75dB typical PSRR at 1kHz (60dB typical at 10KHz)
- 30 μ V RMS output voltage noise (10Hz to 100kHz)
- 65mV typical dropout at 150mA
- 106 μ A typical quiescent current
- Less than 1 μ A typical shutdown mode
- Fast line and load transient response
- 80 μ s typical fast turn-on time
- 2.5V to 5.5V input range
- Stable with small ceramic output capacitors
- Over temperature and over current protection
- \pm 2% output voltage tolerance
- \pm 1% output voltage tolerance for Vout 1.5V

Applications

- Wireless handsets
- PCMCIA cards
- DSP core power
- Hand-held instruments
- Battery-powered systems
- Portable information appliances

Connection Diagrams

TDFN-6(TOP VIEW)

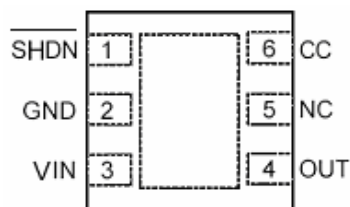

Note: Version also available for pin #1 as FAULT pin and pin #5 as SHDN pin

SOT-25(TOP VIEW)

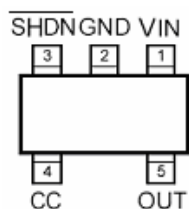

SOT-26(TOP VIEW)

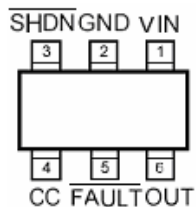

Order information

EMP8915-XXFE06GRR

XX	Operation Code
FE06	TDFN-6 Package
NRR	RoHS & Halogen free package
	Commercial Grade Temperature
	Rating: -40 to 85°C
	Package in Tape & Reel

EMP8915-XXVF05GRR

XX	Operation Code
VF05	SOT-25 Package
GRR	RoHS package
	Commercial Grade Temperature
	Rating: -40 to 85°C
	Package in Tape & Reel

EMP8916-XXVC06GRR

XX	Operation Code
VC06	SOT-26 Package
GRR	RoHS package
	Commercial Grade Temperature
	Rating: -40 to 85°C
	Package in Tape & Reel

Marking & Packing Information

No. of PIN	EN	CC	Fault	Package	Marking		Vout	Product ID
					new	Old (8935/8915)		
5	Y	Y	N	SOT-25		Date code; P621/P611	1.2	EMP8915-12VF05GRR
						Date code; ---/P612	1.3	EMP8915-13VF05GRR
						Date code; P624/P614	1.5	EMP8915-15VF05GRR
						Date code; P627/P617	1.8	EMP8915-18VF05GRR
						Date code; P62E/P61E	2.5	EMP8915-25VF05GRR
						Date code; P62H/P61H	2.8	EMP8915-28VF05GRR
						Date code; ---/P61N	2.85	EMP8915-2QVF05GRR
6	Y	Y	Y	SOT-26			1.2	EMP8916-12VC06GRR
							1.3	EMP8916-13VC06GRR
							1.5	EMP8916-15VC06GRR
							1.8	EMP8916-18VC06GRR
							2.5	EMP8916-25VC06GRR
							2.8	EMP8916-28VC06GRR
							2.85	EMP8916-2QVC06GRR
5	Y	Y	N	TDFN-6			1.2	By request
							1.3	By request
							1.5	By request
							1.8	By request
							2.5	By request
							2.8	By request
							2.85	By request

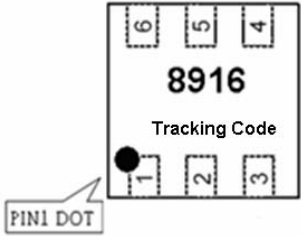
6	Y	Y	Y	TDFN-6		1.2	By request
						1.3	By request
						1.5	By request
						1.8	By request
						2.5	By request
						2.8	By request
						2.85	By request

Typical Application

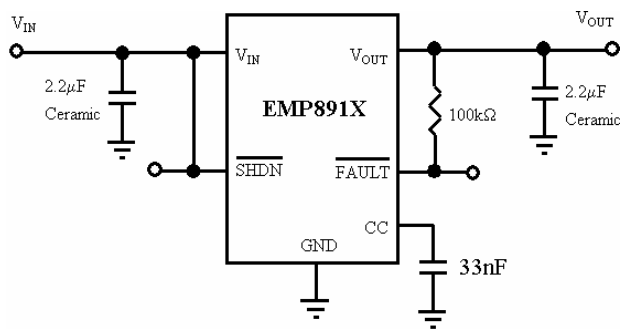

Pin Functions

Name	SOT-25	SOT-26	TDFN-6	Function
VOUT	5	6	4	Output Voltage Feedback.
VIN	1	1	3	Supply Voltage Input. Require a minimum input capacitor of close to 1 μ F to ensure stability and sufficient decoupling from the ground pin.
GND	2	2	2	Ground Pin.
NC			5 or N/A	No Connection
CC	4	4	6	Compensation Capacitor. Connect an optimum 33nF noise bypass capacitor between the CC and the ground pins to reduce noise in VOUT.
$\overline{\text{SHDN}}$	3	3	1 or 5	Shutdown Input. Set the regulator into the disable mode by pulling the $\overline{\text{SHDN}}$ pin low. To keep the regulator on during normal operation, connect the $\overline{\text{SHDN}}$ pin to VIN. The $\overline{\text{SHDN}}$ pin must not exceed VIN under all operating conditions.
$\overline{\text{FAULT}}$		5	N/A or 1	Fault Detection Output. The $\overline{\text{FAULT}}$ pin goes low when the voltage regulating function fails. Because the $\overline{\text{FAULT}}$ pin connects to the open-drain output of a NMOS transistor, a typical 100k Ω pull-up resistor is required to provide the necessary output voltage. The $\overline{\text{FAULT}}$ pin enters the high impedance state during shutdown and it should be connected to ground if unused.

Absolute Maximum Ratings (Notes 1, 2)

V_{IN} , V_{OUT} , $\overline{V_{SHDN}}$, V_{SET} , V_{CC} , $\overline{V_{FAULT}}$	-0.3V to 6.5V
Power Dissipation	(Note 3)
Storage Temperature Range	-65°C to 160°C
Junction Temperature (T _J)	150°C
Lead Temperature (10 sec.)	260°C
ESD Rating	
Human Body Model (Note 5)	2kV

Thermal Resistance (θJA)

TDFN-6	(Note 3)
SOT-25	250°C/W
SOT-26	250°C/W

Operating Ratings (Note 1, 2)

Temperature Range	-40°C to 85°C
Supply Voltage	2.5V to 5.5V

Electrical Characteristics

Unless otherwise specified, all limits guaranteed for $V_{IN} = V_{OUT} + 0.5V$ (Note 6), $\overline{V_{SHDN}} = V_{IN}$, $C_{IN} = C_{OUT} = 2.2\mu F$, $C_{CC} = 33nF$, $T_J = 25^\circ C$. **Boldface** limits apply for the operating temperature extremes: -40°C and 85°C.

Symbol	Parameter	Conditions	Min	Typ (Note 7)	Max	Units
V_{IN}	Input Voltage		2.5		5.5	V
ΔV_{OTL}	Output Voltage Tolerance	$100\mu A \leq I_{OUT} \leq 150mA$ $V_{IN} = V_{OUT(NOM)} + 0.5V$, (Note 6)	-2		+2	% of $V_{OUT(NOM)}$
	1.5V output Voltage Tolerance	$100\mu A \leq I_{OUT} \leq 150mA$ $V_{IN} = V_{OUT(NOM)} + 0.5V$, (Note 6)	-1		+1	% of $V_{OUT(NOM)}$
I_{OUT}	Maximum Output Current	Average DC Current Rating	150			mA
I_{LIMIT}	Output Current Limit		165	280		mA
I_Q	Supply Current	$I_{OUT} = 0mA$		106	210	μA
		$I_{OUT} = 150mA$		145		
	Shutdown Supply Current	$V_{OUT} = 0V$, $\overline{SHDN} = GND$		0.001		
V_{DO}	Dropout Voltage (Note 4), (Note 6)	$I_{OUT} = 1mA$		0.03		mV
		$I_{OUT} = 50mA$		22		
		$I_{OUT} = 150mA$		65		
PSRR	Power-supply rejection ratio $V_{IN}=3.5V$, $V_{OUT}=2.5V$ $I_{OUT}=50mA$	$f = 100Hz$		74		dB
		$f = 1kHz$		75		
		$f = 10kHz$		60		
		$f = 100kHz$		36		
ΔV_{OUT}	Line Regulation	$I_{OUT} = 1mA$, $(V_{OUT} + 0.5V) \leq V_{IN} \leq 5.5V$, (Note 7)		0.02		%/V
	Load Regulation	$100\mu A \leq I_{OUT} \leq 150mA$		0.0004		%/mA
e_n	Output Voltage Noise	$I_{OUT} = 10mA$, $10Hz \leq f \leq 100kHz$		30		μV_{RMS}
$\overline{V_{SHDN}}$	\overline{SHDN} Input Threshold	V_{IH} , $(V_{OUT} + 0.5V) \leq V_{IN} \leq 5.5V$ (Note 6)	1.2			V
		V_{IL} , $(V_{OUT} + 0.5V) \leq V_{IN} \leq 5.5V$ (Note 6)			0.4	
$\overline{I_{SHDN}}$	\overline{SHDN} Input Bias Current	$\overline{SHDN} = GND$ or V_{IN}		0.1	100	nA
$\overline{V_{FAULT}}$	\overline{FAULT} Detection Voltage	$V_{OUT} \geq 2.5V$, $I_{OUT} = 150mA$ (Note 8)		95		mV

	$\overline{\text{FAULT}}$ Output Low Voltage	$I_{\text{SINK}} = 2\text{mA}$		0.2		V
I_{FAULT}	$\overline{\text{FAULT}}$ Off-Leakage Current	$\overline{\text{FAULT}} = 3.6\text{V}, \text{SHDN} = 0\text{V}$		0.1	100	nA
T_{SD}	Thermal Shutdown Temperature			165		°C
	Thermal Shutdown Hysteresis			30		
T_{ON}	Turn-On Time	V_{OUT} at 95% of Final Value		80		µs

Note 1: Absolute Maximum ratings indicate limits beyond which damage may occur. Electrical specifications are not applicable when the device is operated outside of its rated operating conditions.

Note 2: All voltages are defined and measured with respect to the potential at the ground pin.

Note 3: Maximum Power dissipation for the device is calculated using the following equations:

$$P_D = \frac{T_{J(\text{MAX})} - T_A}{\theta_{JA}}$$

where $T_{J(\text{MAX})}$ is the maximum junction temperature, T_A is the ambient temperature, and θ_{JA} is the junction-to-ambient thermal resistance. E.g. for the SOT-25 package $\theta_{JA} = 250^\circ\text{C}/\text{W}$, $T_{J(\text{MAX})} = 150^\circ\text{C}$ and using $T_A = 25^\circ\text{C}$, the maximum power dissipation is found to be 500mW. The derating factor $(-1/\theta_{JA}) = -4\text{mW}/^\circ\text{C}$, thus below 25°C the power dissipation figure can be increased by 4mW per degree, and similarly decreased by this factor for temperatures above 25°C . The value of the θ_{JA} for the TDFN package is specifically dependent on the PCB trace area, trace material, and the number of layers and thermal vias.

Note 4: Dropout voltage is measured by reducing V_{IN} until V_{OUT} drops 100mV from its nominal value at $V_{\text{IN}} - V_{\text{OUT}} = 0.5\text{V}$. Dropout voltage does not apply to the regulator versions with V_{OUT} less than 2.5V.

Note 5: Human body model: 1.5kΩ in series with 100pF.

Note 6: Condition does not apply to input voltages below 2.5V since this is the minimum input operating voltage.

Note 7: Typical Values represent the most likely parametric norm.

Note 8: The $\overline{\text{FAULT}}$ detection voltage is specified for the input to output voltage differential at which the $\overline{\text{FAULT}}$ pin goes active low.

Functional Block Diagram

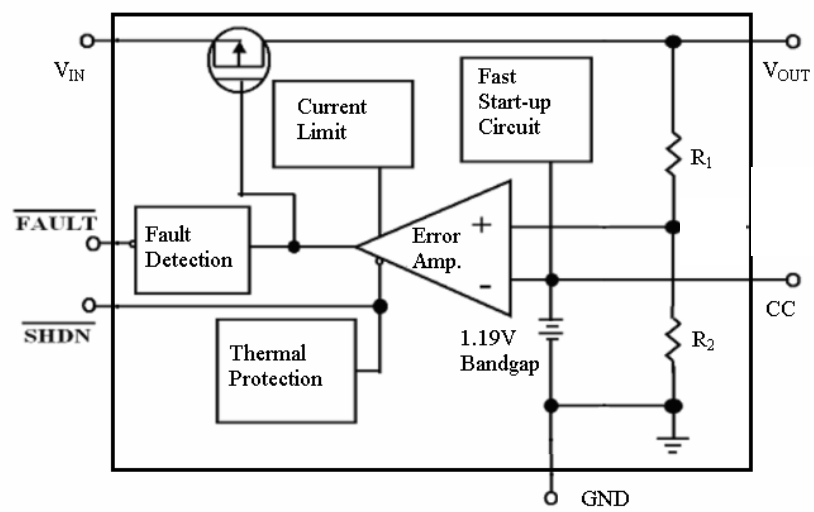
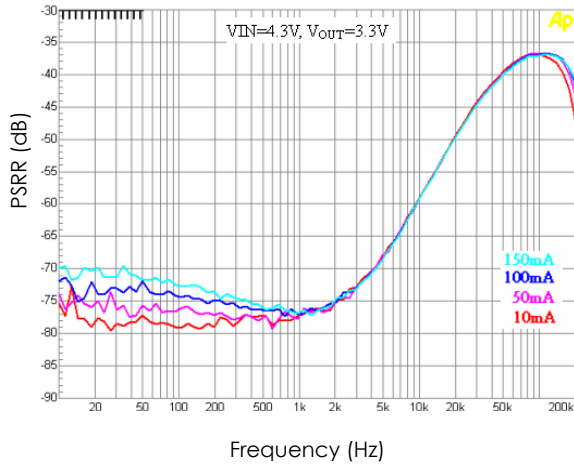

Fig.1. EMP891X Functional Block Diagram

Typical Performance Characteristics

Unless otherwise specified, $V_{IN} = V_{OUT(NOM)} + 0.2V$, $C_{IN} = C_{OUT} = 2.2\mu F$, $C_{CC} = 33nF$, $T_A = 25^\circ C$, $V_{SHDN} = V_{IN}$.

PSRR vs Frequency



PSRR vs Frequency

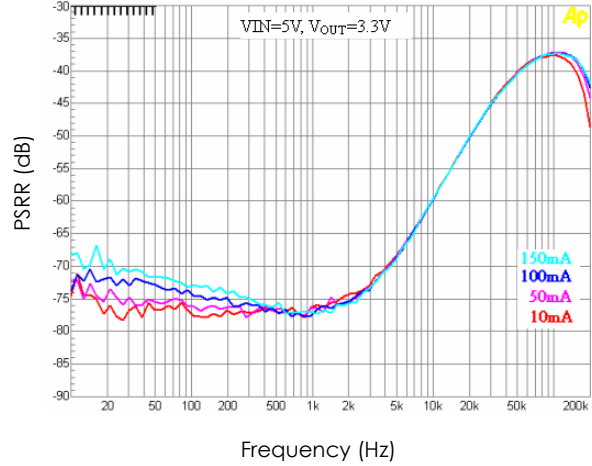

PSRR vs Frequency

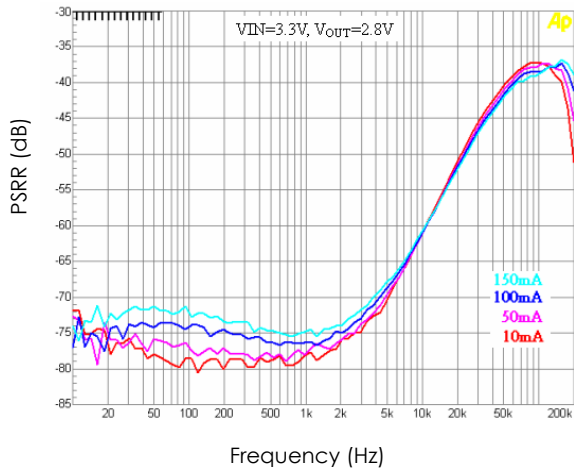

PSRR vs Frequency

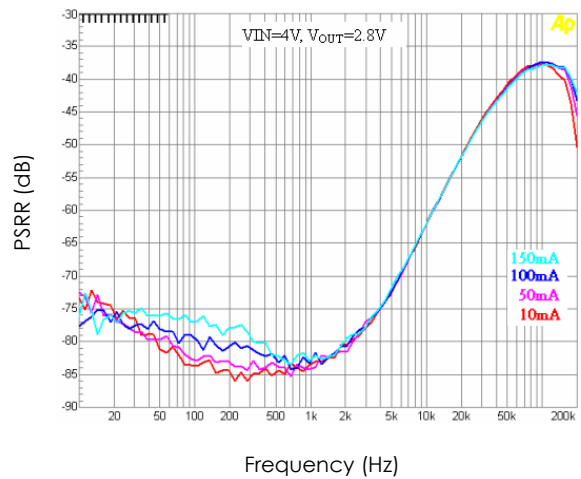

PSRR vs Frequency

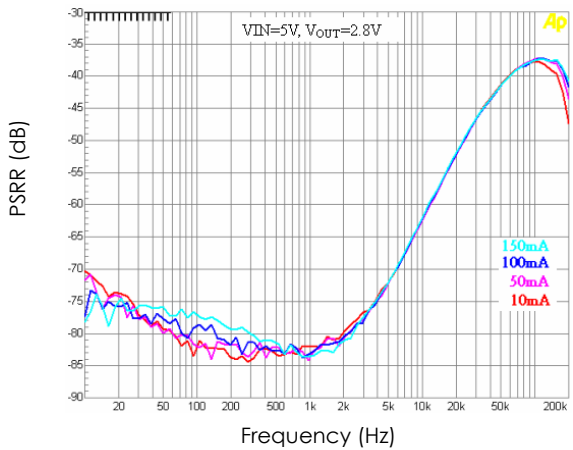

PSRR vs Frequency

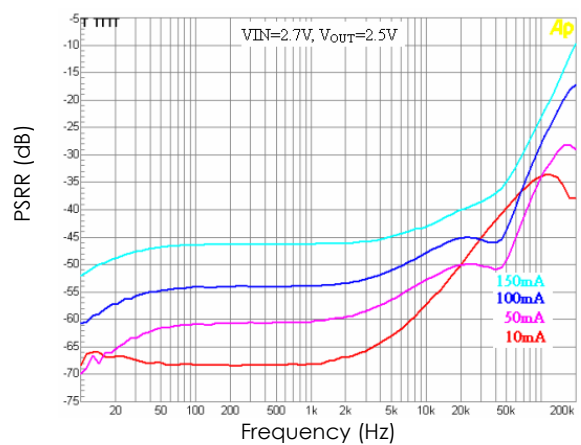

Typical Performance Characteristics Unless otherwise specified, $V_{IN} = V_{OUT(NOM)} + 0.2V$, $C_{IN} = C_{OUT} = 2.2\mu F$, $C_{CC} = 33nF$, $T_A = 25^\circ C$, $V_{SHDN} = V_{IN}$. (Continued)

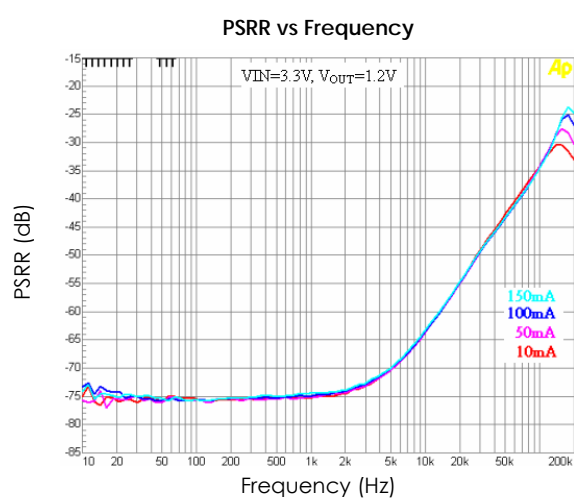
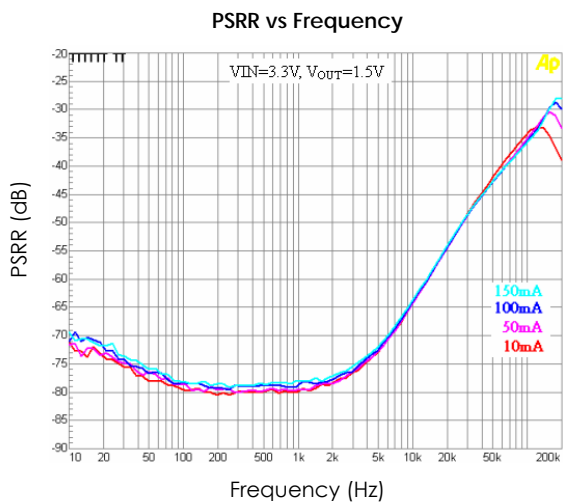
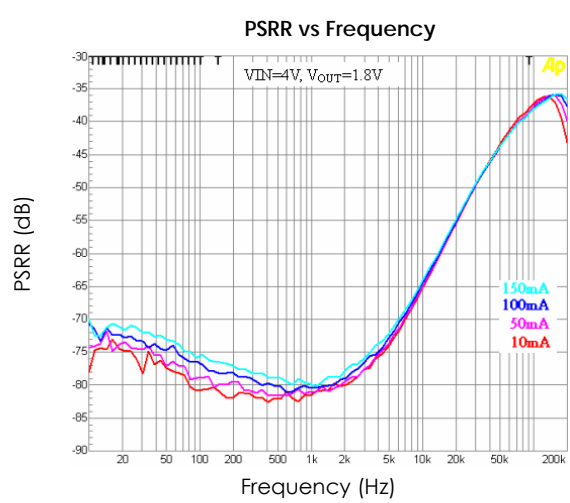
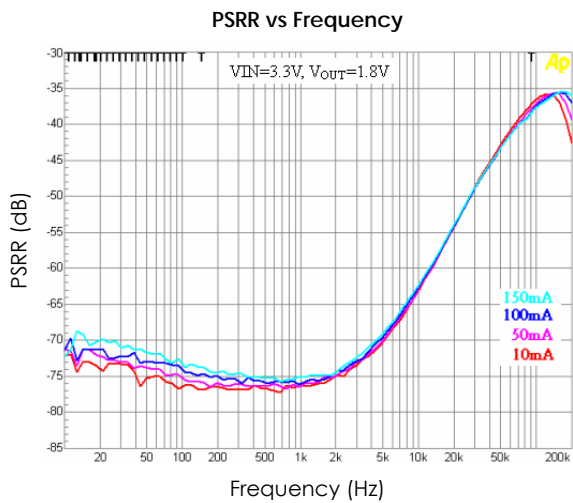
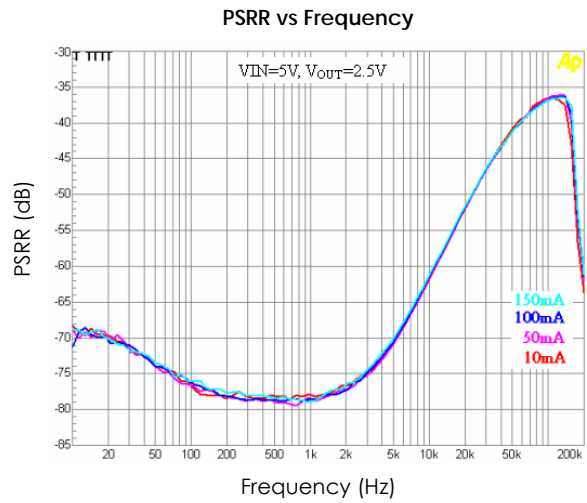
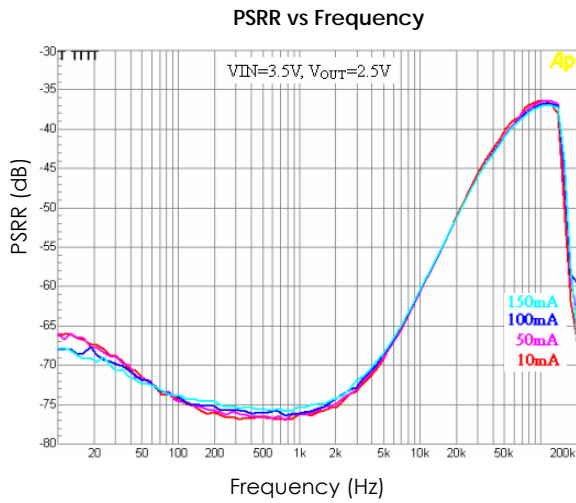

Typical Performance Characteristics Unless otherwise specified, $V_{IN} = V_{OUT(NOM)} + 0.2V$, $C_{IN} = C_{OUT} = 2.2\mu F$, $C_{CC} = 33nF$, $T_A = 25^\circ C$, $V_{SHDN} = V_{IN}$. (Continued)

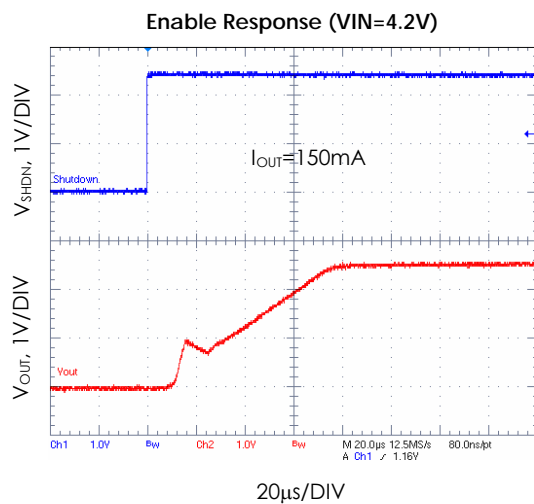
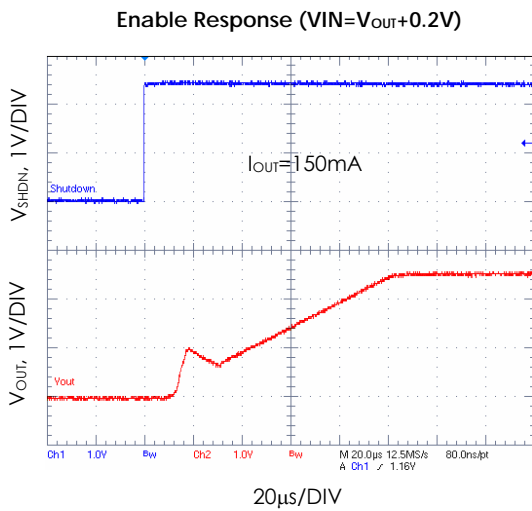
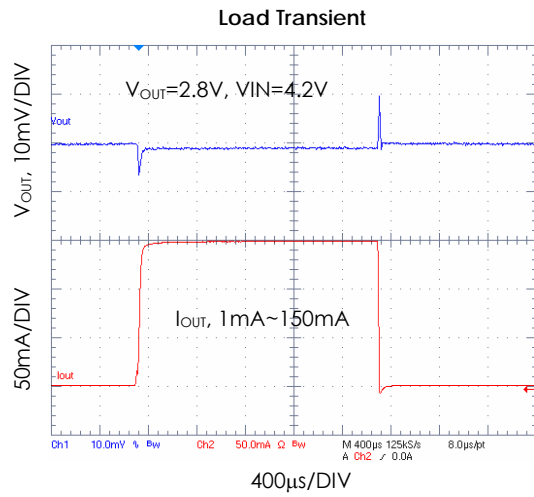
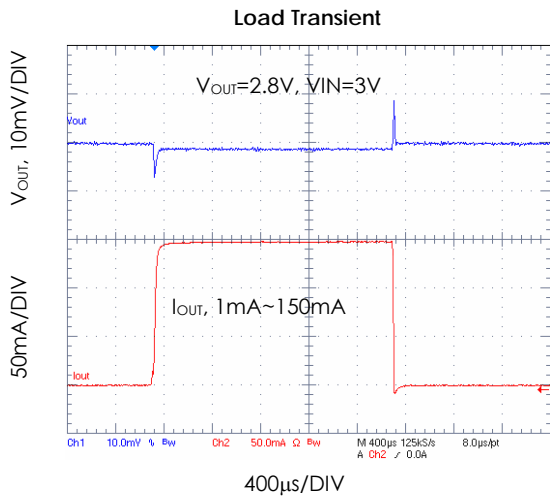
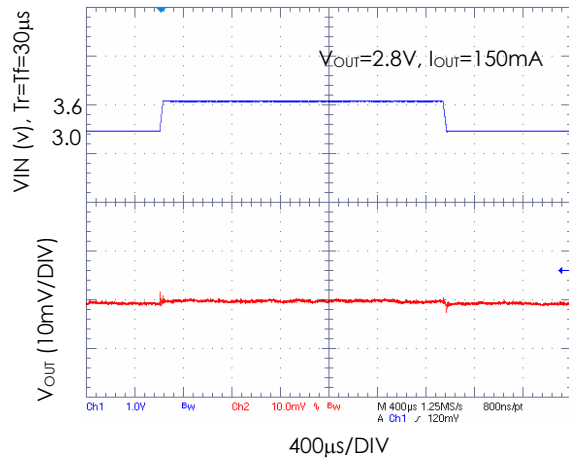
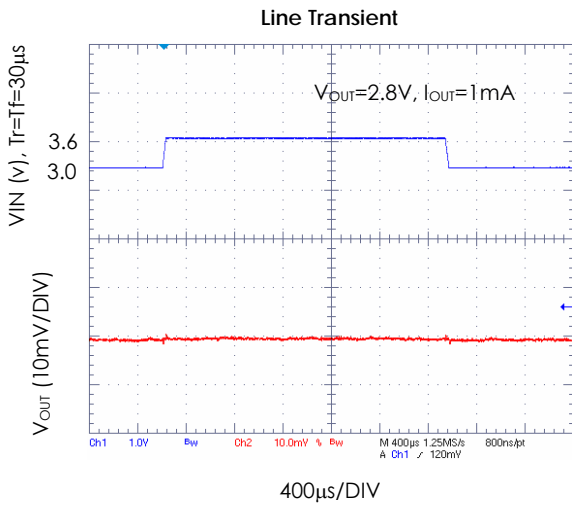

Line Transient

Typical Performance Characteristics Unless otherwise specified, $V_{IN} = V_{OUT(NOM)} + 0.2V$, $C_{IN} = C_{OUT} = 2.2\mu F$, $C_{CC} = 33nF$, $T_A = 25^\circ C$, $V_{SHDN} = V_{IN}$. (Continued)

Dropout Voltage vs. Load Current

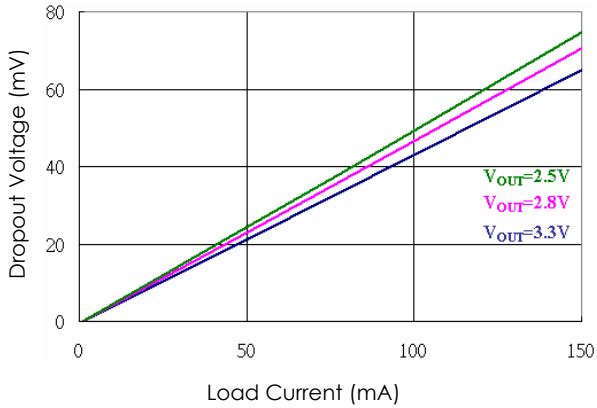

Fault Detect Threshold vs. Load Current

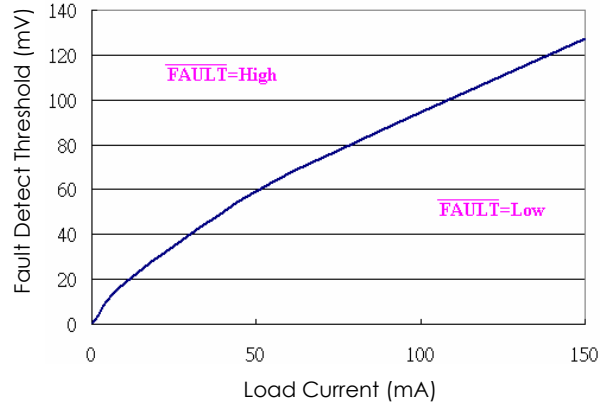

Supply Current vs. Input Voltage

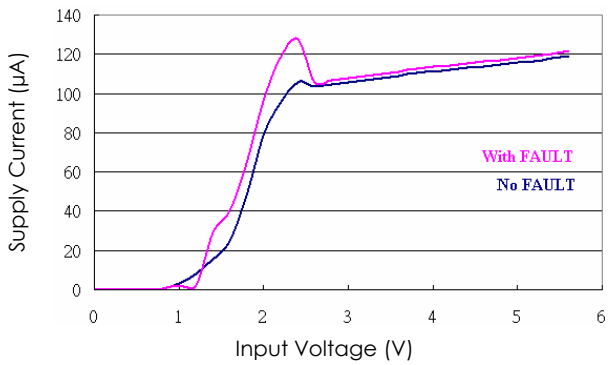

Supply Current vs. Load Current

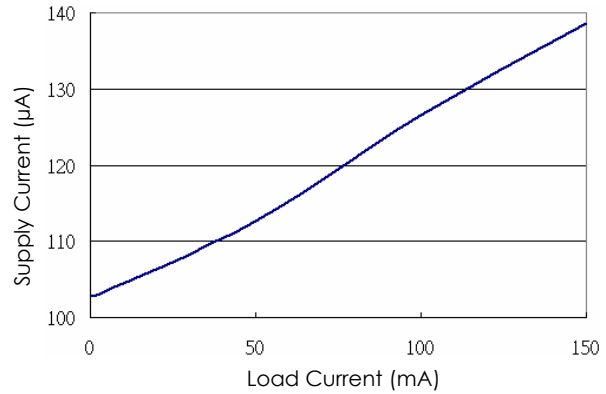

Power-Down Response

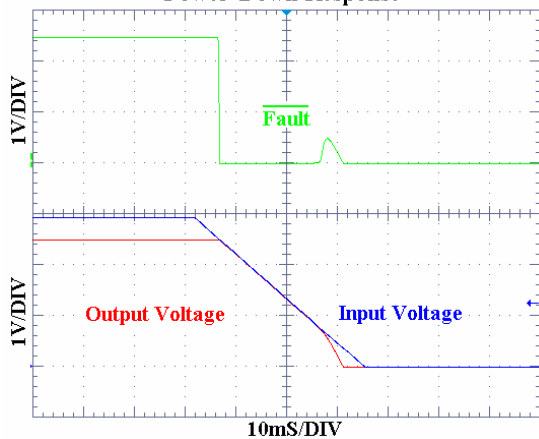

Power-Up Response

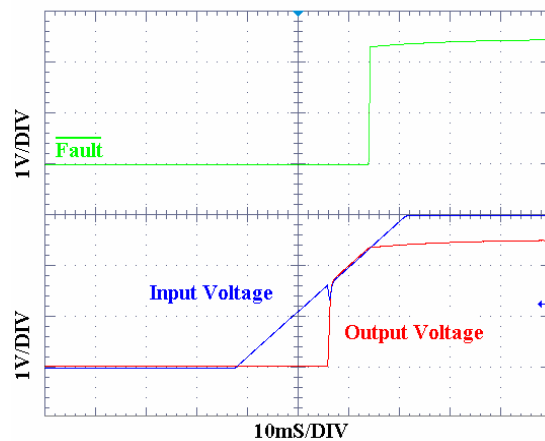

Typical Performance Characteristics Unless otherwise specified, $V_{IN} = V_{OUT(NOM)} + 0.2V$, $C_{IN} = C_{OUT} = 2.2\mu F$, $C_{CC} = 33nF$, $T_A = 25^\circ C$, $V_{SHDN} = V_{IN}$. (Continued)

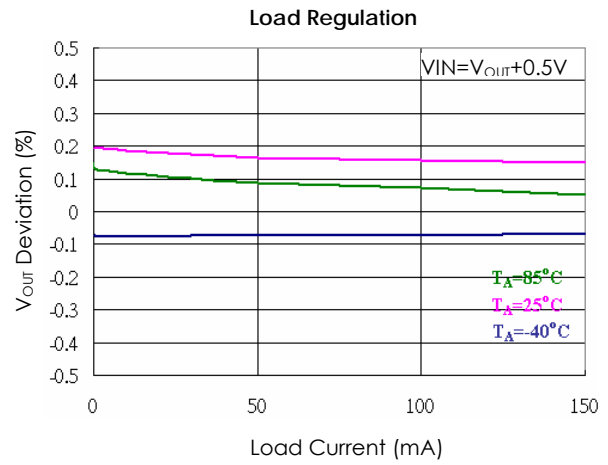
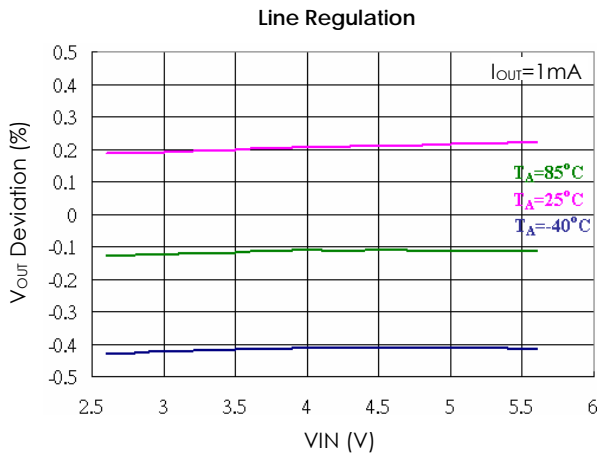

Application Information

General Description

Referring to Figure 1 of the Functional Block Diagram, the EMP891X is designed in such a way that a negative feedback control is used to perform the desired voltage regulating function. The negative feedback is formed by using feedback resistors (R1, R2) to sample the output voltage for the non-inverting input of the error amplifier, whose inverting input is set to the bandgap reference voltage. Due to its high open-loop gain, the error amplifier operates to ensure that the sampled output feedback voltage at its non-inverting input is virtually equal to the preset bandgap reference voltage. These feedback resistors can be either internal or external to the EMP891X, depending on whether a preset or an adjustable output voltage version is being used.

To control the amount of current reaching the output, the error amplifier compares the voltage difference at its inputs and produces an appropriate driving voltage to the P-channel MOS pass transistor. If there are changes in the output voltage due to load changes, the feedback resistors register such changes to the non-inverting input of the error amplifier. The error amplifier then adjusts its driving voltage to maintain virtual short between its two input nodes under all loading conditions. Hence, the regulation of the output voltage is achieved as a direct result of the error amplifier keeping its input voltages equal. This negative feedback control topology is further augmented by the shutdown, the fault detection, and the temperature and current protection circuitry.

Output Capacitor

To take advantage of the savings in cost and space as well as the superior filtering of high frequency noise, the EMP891X is specially designed for use with ceramic output capacitors of as low as 2.2 μ F. Capacitors of higher value or other types may be used, as long as its equivalent series resistance (ESR) is restricted to less than

0.5 Ω . The use of larger capacitors with smaller ESR values is desirable for applications involving large and fast input or output transients, as well as for situations where the application systems are not physically located immediately adjacent to the battery power source. Typical ceramic capacitors suitable for use with the EMP891X are X5R and X7R. The X5R and the X7R capacitors are able to maintain their capacitance values to within $\pm 20\%$ and $\pm 10\%$, respectively, as the temperature increases.

No-Load Stability

The EMP891X can maintain stable operation during no-load conditions, a required feature for some applications such as CMOS RAM keep-alive operations.

Input Capacitor

A minimum input capacitance of 1 μ F is required for EMP891X. The capacitor value may be increased without limit. Caution should be taken as the instability may result from long supply lead inductance coupling to the output through the gate capacitance of the pass transistor. This will establish a pseudo LCR network, and is likely to happen under high current conditions or near dropout. A 10 μ F tantalum input capacitor will dampen the parasitic LCR action thanks to its high ESR. However, cautions should be exercised to avoid regulator short-circuit damage when tantalum capacitors are used, for they are prone to fail in short-circuit operating conditions.

Compensation (Noise Bypass) Capacitor

To reduce the output voltage noise of the EMP891X, the bypass capacitor C_{CC} (33nF optimum) can be connected between pin CC and the ground. Because pin CC connects directly to the high impedance output of the bandgap reference circuit, the level of the DC leakage currents in the C_{CC} capacitors used will adversely reduce the regulator output voltage. This sets the DC leakage level as the key selection criterion of

Application Information (Continued)

the C_{CC} capacitor types for use with the EMP891X. NPO and COG ceramic capacitors typically offer very low leakage. Although the use of the C_{CC} capacitors does not affect the transient response, it does affect the turn-on time of the regulator. Tradeoff exists between output noise level and turn-on time when selecting the C_{CC} capacitor value.

Power Dissipation and Thermal Shutdown

Excessive power dissipation may cause thermal overload, and hence the increase of the IC junction temperature beyond a safe operating level. The EMP891X relies on dedicated thermal shutdown circuitry to limit its total power dissipation. An IC junction temperature T_J exceeding 165°C will trigger the thermal shutdown logic, turning off the P-channel MOS pass transistor. The pass transistor turns on again after the junction cools off by about 30°C.

When continuous thermal overload conditions persist, this thermal shutdown action then results in a pulsed waveform at the output of the regulator. The concept of thermal resistance θ_{JA} (°C/W) is often used to describe an IC junction's relative readiness in allowing its thermal energy to dissipate to its ambient air. An IC junction with a low thermal resistance is preferred because it is relatively effective in dissipating its thermal energy to its ambient, thus resulting in a relatively low and desirable junction temperature. The relationship between θ_{JA} and T_J is as follows:

$$T_J = \theta_{JA} (P_D) + T_A$$

T_A is the ambient temperature, and P_D is the power generated by the IC and can be written as:

$$P_D = I_{OUT} (V_{IN} - V_{OUT})$$

As the above equations indicate, it is desirable to work

with ICs whose θ_{JA} values are small such that T_J does not increase strongly with P_D . To avoid thermally overloading the EMP891X, refrain from exceeding the absolute maximum junction temperature rating of 150°C under continuous operating conditions. Overstressing the regulator with high loading currents and elevated input-to-output differential voltages can increase the IC die temperature significantly.

Fault Detection

In the event of the occurrence of various fault conditions that cause failure in the output voltage regulation, such as during thermal overload or current limit, the $\overline{\text{FAULT}}$ pin of the EMP891X becomes low. Because the $\overline{\text{FAULT}}$ pin connects to the open-drain output of a N-channel MOS transistor, a large pull-up resistor (100k Ω typical) is required to provide the necessary output voltage and yet without compromising the overall power consumption performance of the regulator. The $\overline{\text{FAULT}}$ pin also goes low when the input-to-output differential voltage becomes too small to sustain good load and line regulation at the output. This occurs typically during near dropout when the input-to-output differential voltage is less than 95mV for a load current of 150mA. The EMP891X detects near dropout conditions by comparing the differential voltage against a predefined differential threshold that is always slightly above the dropout voltage. This differential threshold is dynamical in the sense that it not only tracks the dropout voltage as the load current varies, but also scale linearly with the load current.

Shutdown

When the $\overline{\text{SHDN}}$ pin is low, the EMP891X enters the sleep mode. When this occurs, the pass transistor, the error amplifier, and the biasing circuits, including the bandgap reference, are turned off, thus reducing the

Application Information (Continued)

supply current to typically 1nA. Such a low supply

current makes the EMP891X an ideal device for battery-powered applications. The maximum guaranteed voltage at the $\overline{\text{SHDN}}$ pin for the sleep mode to take effect is 0.4V. A minimum guaranteed voltage of 1.2V at the $\overline{\text{SHDN}}$ pin activates the EMP891X. Direct connection of the $\overline{\text{SHDN}}$ pin to the V_{IN} to keep the regulator on is allowed for the EMP891X. The $\overline{\text{SHDN}}$ pin must not exceed the supply voltage V_{IN} under all conditions.

Fast Start-Up

Fast start-up time is one of the important factors for overall system efficiency improvement. The EMP891X has a fast start-up speed when using the optional noise bypass capacitor (C_{CC}). To shorten start-up time, the EMP891X internally supplies a 500 μA current to charge up the capacitor until it reaches about 95% of its final value.

Physical Dimensions

SOT-25

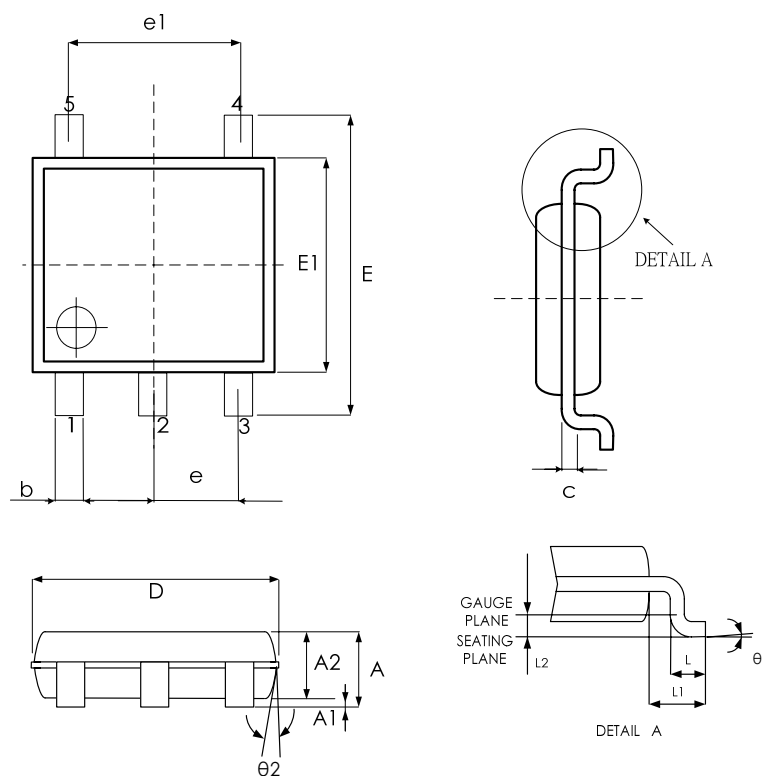

SYMBPLS	MIN.	NOM.	MAX.
A	1.05	1.20	1.35
A1	0.05	0.10	0.15
A2	1.00	1.10	1.20
b	0.30	—	0.50
c	0.08	—	0.20
D	2.80	2.90	3.00
E	2.60	2.80	3.00
E1	1.50	1.60	1.70
e	0.95 BSC		
e1	1.90 BSC		
L	0.30	0.45	0.55
L1	0.60 REF		
θ°	0	5	10
$\theta2^\circ$	6	8	10

UNIT: MM

SOT-26

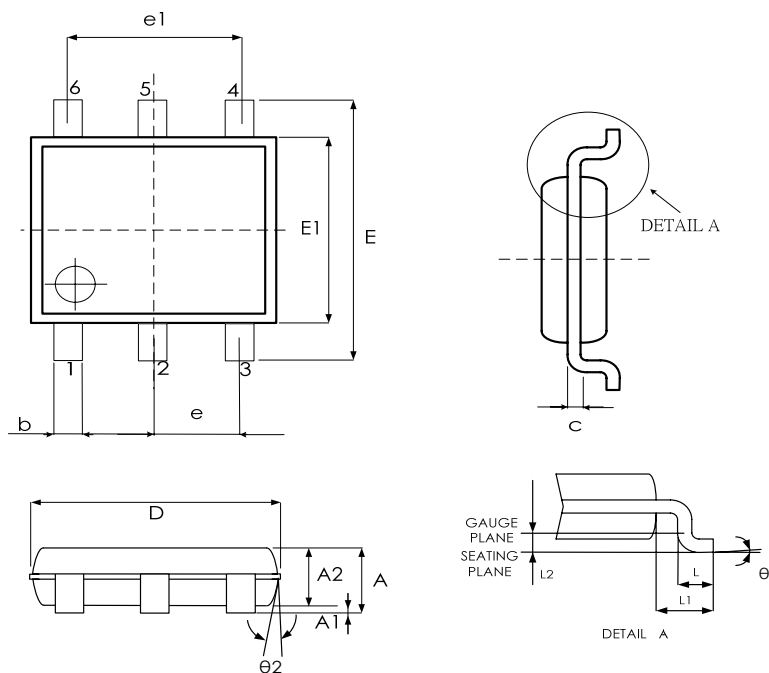

SYMBPLS	MIN.	NOM.	MAX.
A	—	—	1.45
A1	—	—	0.15
A2	0.9	1.15	1.3
b	0.3	—	0.5
c	0.08	—	0.22
D	2.90 BSC.		
E	2.80 BSC.		
E1	1.60 BSC.		
e	0.95 BSC		
e1	1.90 BSC		
L	0.3	0.45	0.6
L1	0.60 REF		
L2	0.25 REF		
θ°	0	4	8
$\theta2^\circ$	5	10	15

UNIT: MM

TDFN-6

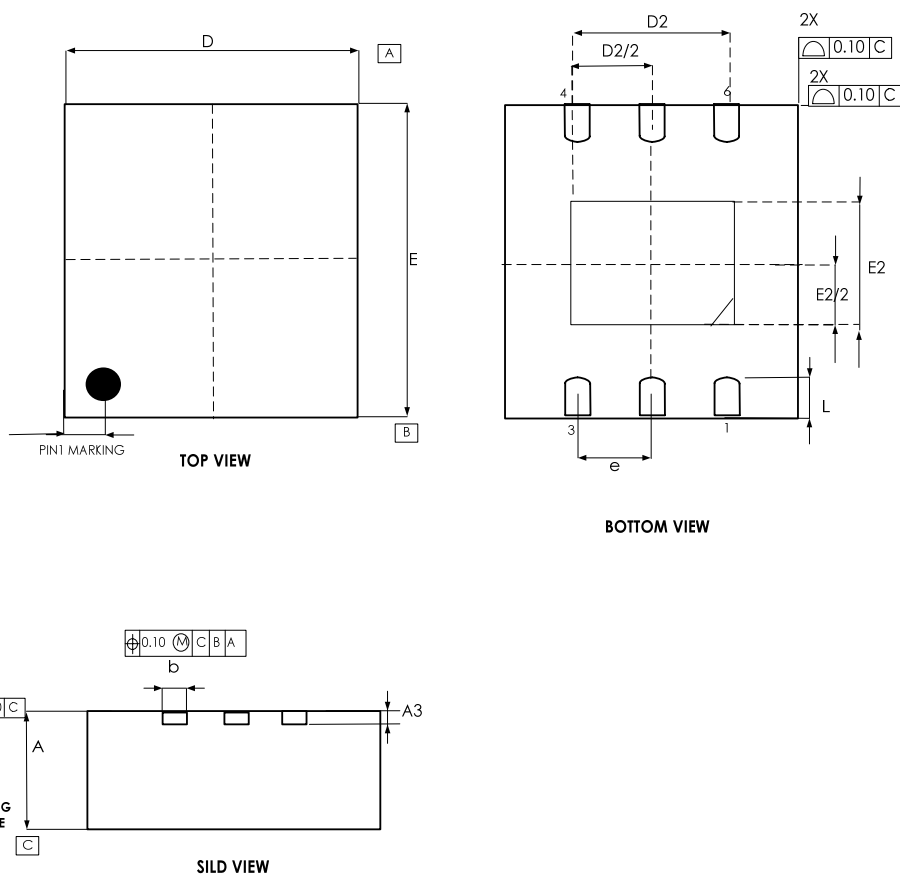

SYMBOL	COMMON					
	DIMENSIONS MILLIMETER			DIMENSIONS INCH		
	MIN.	NOM.	MAX.	MIN.	NOM.	MAX.
A	0.70	0.75	0.80	0.027	0.029	0.031
A3	0.200 REF			0.008 REF		
b	0.25	0.30	0.35	0.010	0.012	0.014
D	2.00 BSC			0.079 BSC		
D2	1.20	1.30	1.40	0.046	0.050	0.054
E	2.00 BSC			0.079 BSC		
E2	0.50	0.60	0.70	0.022	0.024	0.026
e	0.650 BSC			0.026 BSC		
L	0.25	0.30	0.35	0.009	0.011	0.013

Revision History

Revision	Date	Description
5.0	2009.03.24	EMP transferred from version 4.1

Important Notice

All rights reserved.

No part of this document may be reproduced or duplicated in any form or by any means without the prior permission of ESMT.

The contents contained in this document are believed to be accurate at the time of publication. ESMT assumes no responsibility for any error in this document, and reserves the right to change the products or specification in this document without notice.

The information contained herein is presented only as a guide or examples for the application of our products. No responsibility is assumed by ESMT for any infringement of patents, copyrights, or other intellectual property rights of third parties which may result from its use. No license, either express, implied or otherwise, is granted under any patents, copyrights or other intellectual property rights of ESMT or others.

Any semiconductor devices may have inherently a certain rate of failure. To minimize risks associated with customer's application, adequate design and operating safeguards against injury, damage, or loss from such failure, should be provided by the customer when making application designs.

ESMT's products are not authorized for use in critical applications such as, but not limited to, life support devices or system, where failure or abnormal operation may directly affect human lives or cause physical injury or property damage. If products described here are to be used for such kinds of application, purchaser must do its own quality assurance testing appropriate to such applications.