

# Emitter common (dual digital transistors)

## EMS1 / UMS1N / FMS1A

**●Features**

- 1) Two 2SA1037AK chips in a EMT or UMT or SMT package.
- 2) Mounting cost and area can be cut in half.

**●Structure**

Epitaxial planar type  
PNP silicon transistor

The following characteristics apply to both Tr1 and Tr2.

**●Equivalent circuit**

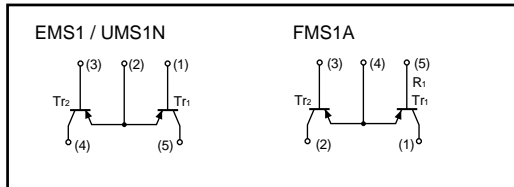

**●Absolute maximum ratings (Ta = 25°C)**

Parameter	Symbol	Limits	Unit
Collector-base voltage	$V_{CB0}$	-60	V
Collector-emitter voltage	$V_{CE0}$	-50	V
Emitter-base voltage	$V_{EB0}$	-6	V
Collector current	$I_c$	150	mA
Collector power dissipation	EMS1, UMS1N	150 (TOTAL)	mW *1
	FMS1A	300 (TOTAL)	
Junction temperature	$T_j$	150	°C
Storage temperature	$T_{stg}$	-55~+150	°C

\*1 120mW per element must not be exceeded.  
\*2 200mW per element must not be exceeded.

**●External dimensions (Units : mm)**

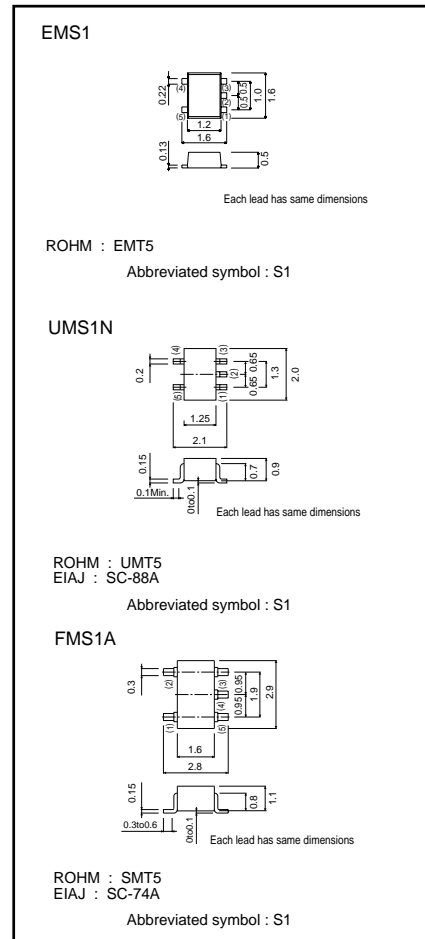

Transistors

●Electrical characteristics (Ta = 25°C)

Parameter	Symbol	Min.	Typ.	Max.	Unit	Conditions
Collector-base breakdown voltage	BV <sub>CB0</sub>	-60	-	-	V	I <sub>c</sub> =-50μA
Collector-emitter breakdown voltage	BV <sub>CE0</sub>	-50	-	-	V	I <sub>c</sub> =-1mA
Emitter-base breakdown voltage	BV <sub>EB0</sub>	-6	-	-	V	I <sub>e</sub> =-50μA
Collector cutoff current	I <sub>cBO</sub>	-	-	-0.1	μA	V <sub>CB</sub> =-60V
Emitter cutoff current	I <sub>eBO</sub>	-	-	-0.1	μA	V <sub>EB</sub> =-5V
Collector-emitter saturation voltage	V <sub>CE(sat)</sub>	-	-	-0.5	V	I <sub>c</sub> /I <sub>B</sub> =-50mA/-5mA
DC current transfer ratio	h <sub>FE</sub>	120	-	560	-	V <sub>CE</sub> =-6V, I <sub>c</sub> =-1mA
Transition frequency	f <sub>T</sub>	-	140	-	MHZ	V <sub>CE</sub> =-12V, I <sub>E</sub> =2mA, f=100MHZ
Output capacitance	C <sub>ob</sub>	-	3	4.5	PF	V <sub>CB</sub> =-12V, I <sub>E</sub> =0A, f=1MHZ

●Packaging specifications

Type	Package	Taping		
	Code	T2R	TR	T148
	Basic ordering unit (pieces)	8000	3000	3000
EMS1	○	—	—	—
UMS1N	—	○	—	—
FMS1A	—	—	—	○

●Electrical characteristic curves

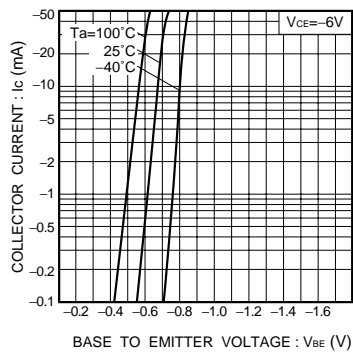

Fig.1 Grounded emitter propagation characteristics

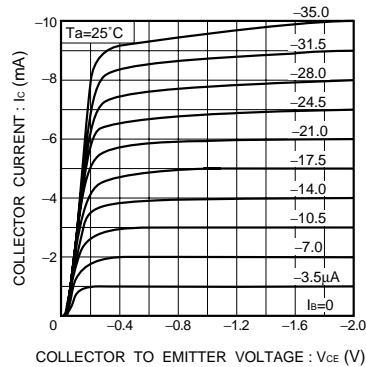

Fig.2 Grounded emitter output characteristics ( I )

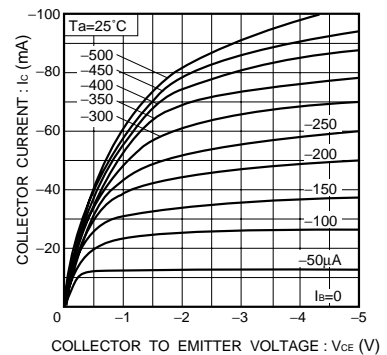

Fig.3 Grounded emitter output characteristics ( II )

Transistors

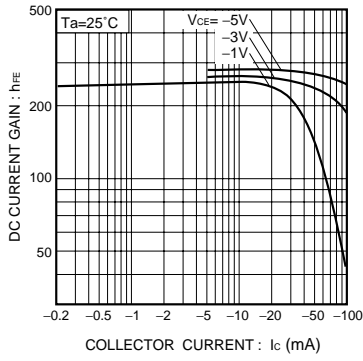

Fig.4 DC current gain vs. collector current ( I )

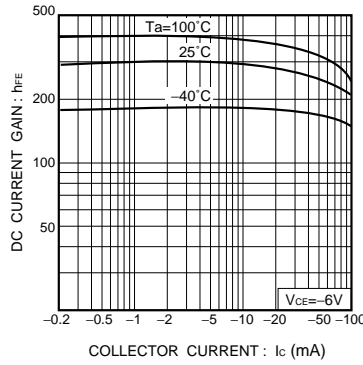

Fig.5 DC current gain vs. collector current ( II )

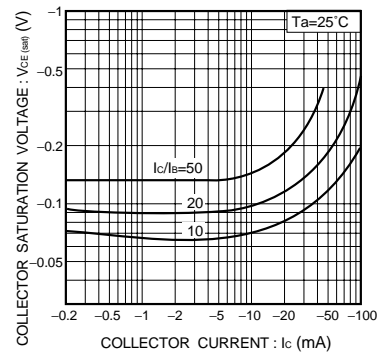

Fig.6 Collector-emitter saturation voltage vs. collector current ( I )

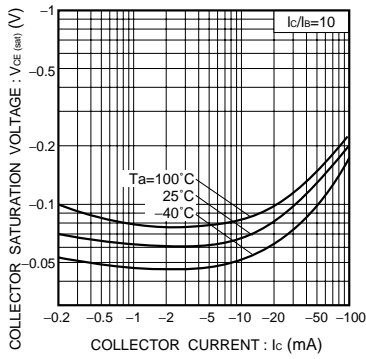

Fig.7 Collector-emitter saturation voltage vs. collector current ( II )

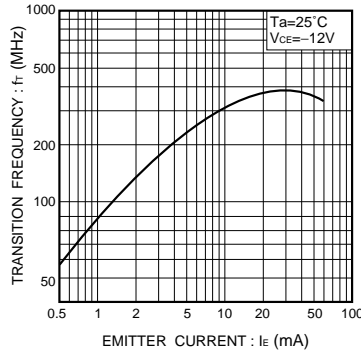

Fig.8 Gain bandwidth product vs. emitter current

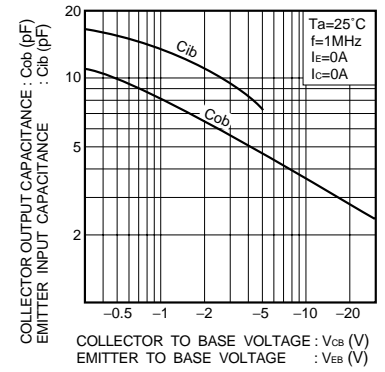

Fig.9 Collector output capacitance vs. collector-base voltage  
Emitter input capacitance vs. emitter-base voltage