

ELPAQ

ELPAQ

EMS256K8C

A division of ELMO Semiconductor Corp.

70 - 100ns**2Mb CMOS STATIC SRAM****FEATURES**

- High density SRAM module
- Organized as 262,144 x 8
- Access time 70 - 100ns
- Low power consumption
Standby: 25 μ W(typ.)
Operating: 200mW(typ.)
- Power supply voltage 5V \pm 10%
- TTL compatible inputs and outputs
- Fully static operation
- 32 pin DIP package
- JEDEC standard pinout
- MIL or commercial temperature range

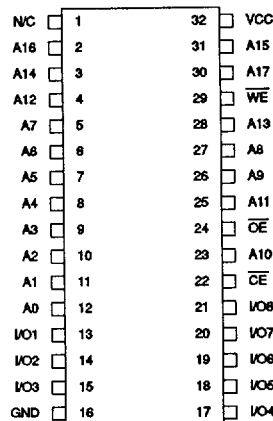
Pin Configuration**Pin Description**

A0 - A17	Address Inputs
I/O1 - I/O8	Data Inputs/Outputs
\overline{CE}	Chip Enable
\overline{OE}	Output Enable
\overline{WE}	Write Enable
VCC	Power Supply
GND	Ground

GENERAL DESCRIPTION

The ELPAQ EMS256Kx8C is a high performance 2Mb CMOS SRAM module organized as 262,144 bytes of 8 bits each, using two 1Mb SRAMs and a decoder. The EMS256Kx8C is packaged in a 32 lead 600 mil wide ceramic or plastic DIP package. The module is offered in a variety of temperature and speed combinations.

All inputs and outputs are TTL compatible and the module operates from a single 5V power supply. The EMS256Kx8C is a fully asynchronous SRAM and requires no clocks for operation. The module is also available in Low Power and Low Power with Data Retention versions for applications where low current and low stand-by voltages are required.

Writing data to the module is accomplished by bringing the chip enable (\overline{CE}) and write enable (\overline{WE}) inputs LOW. Data present on the eight I/O pins (I/O₁ - I/O₈) of the device is then written into the memory location specified by the address inputs (A₀ - A₁₆). Reading data from the device is accomplished by bringing chip enable (\overline{CE}) and (\overline{OE}) LOW while write enable remains inactive or HIGH. The data in the location specified by the address inputs will appear on the I/O pins.

www.DataSheet4U.com

www.DataSheet4U.com

ELPAQ

ELPAQ

EMS256K8C

A division of ELMO Semiconductor Corp.

70 - 100ns

BLOCK DIAGRAM

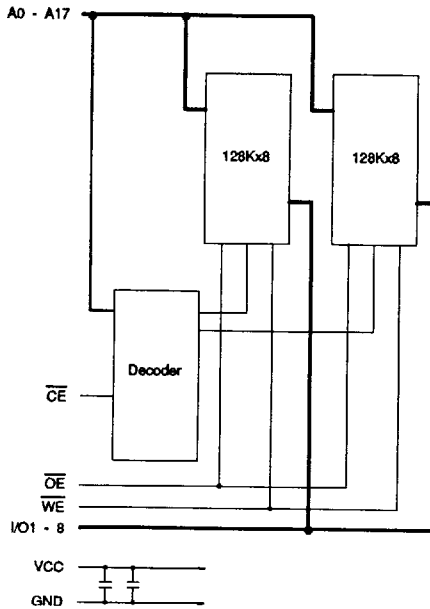

PACKAGE OUTLINE

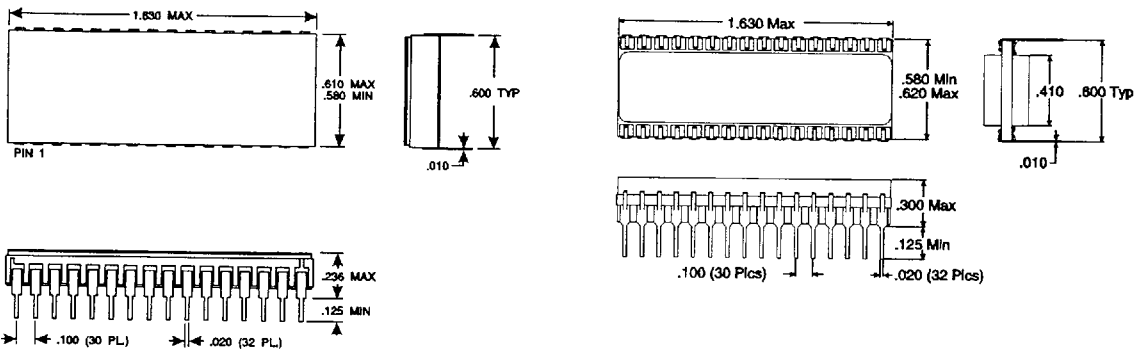

Package Type MO2, 32 Lead .600" Sidebrazed DIP

Package Type MO6, 32 Lead .600" Plastic DIP

ELPAQ

ELPAQ

EMS256K8C

A division of ELMO Semiconductor Corp.

70 - 100ns**ABSOLUTE MAXIMUM RATINGS****Storage Temperature**

Ceramic Packages	-65°C to +150°C
Plastic Packages	-55°C to +125°C

Voltage and Current

Supply Voltage	-0.5 to +7.0V
Input Voltage	-0.5 to Vcc+0.5V
Input/Output Voltage	-0.5 to Vcc+0.5V
Allowable Power Dissipation	1W

Soldering Temperature*Time 260°C * 10s

OPERATING RANGES**Operating Temperature**

Commercial	0°C to +70°C
Industrial	-40°C to +85°C
Military	-55°C to +125°C

Voltage and Current

Supply Voltage	4.5 to 5.5V
Input High Voltage	2.2 to Vcc+0.3V
Input Low Voltage	-0.3 to 0.8V

FUNCTIONAL TRUTH TABLE

\overline{CE}	\overline{OE}	\overline{WE}	Mode	I/O1 - 8	Vcc Current
H	X	X	Not Selected	High Z	ISB1, ISB2
L	H	H	Output Disable	High Z	ICC
L	L	H	Read	Data Out	ICC
L	X	L	Write	Data In	ICC

CAPACITANCE (Ta=25°C, f=1MHz)

Item	Symbol	Test Conditions	Min.	Typ.	Max.	Unit
Input Capacitance	CIN	VIN = 0V		15	25	pF
Input/Output Capacitance	CIO	VIO = 0V		20	25	pF

Note: This parameter is sample tested and not 100% tested.

ELPAQ

ELPAQ

EMS256K8C

A division of ELMO Semiconductor Corp.

70 - 100ns**DC CHARACTERISTICS (V_{CC}=5V±10%, T_a=T_{opr})**

Item	Symbol	Test Condition	Min.	Typ.	Max.	Unit
Input Leakage Current	IIL	V _{IN} =GND or V _{CC}	-10		10	μA
Output Leakage Current	IOL	V _{I/O} =GND or V _{CC} , \overline{CE} =V _{IH} O \overline{E} =V _{IH} or \overline{WE} =V _L	-10		10	μA
Average Operating Current	ICC	Min. Cycle, I _{out} =0mA		40	70	mA
Standby Current	ISB1	\overline{CE} ≥V _{CC} -0.2V, V _{IN} ≥V _{CC} -0.2V		0.005	1.5	mA
	ISB2	\overline{CE} =V _{IH} , V _{IN} =V _L or V _{IH}		2	5	mA
Output High Voltage	VOH	I _{OH} =-1.0mA	2.4			V
Output Low Voltage	VOL	I _{OL} =2.1mA			0.4	V

AC CHARACTERISTICS (V_{CC}=5V±10%, T_a=T_{opr})**AC Test Conditions**

Item	Condition
Input Pulse High Level	V _{IH} =3V
Input Pulse Low Level	V _L =0V
Input Pulse Rise Time	t _r =5ns
Input Pulse Fall Time	t _f =5ns
Input and Output Timing Level	1.5V
Output Load	Fig. 1

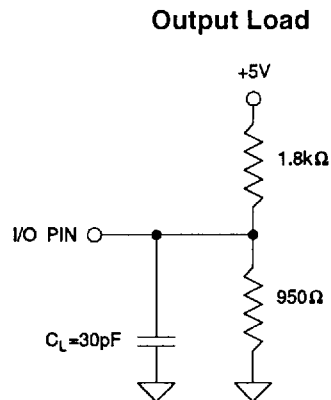

Fig. 1

ELPAQ

ELPAQ

EMS256K8C

A division of ELMO Semiconductor Corp.

70 - 100ns**Read Cycle**

Item	Symbol	-70		-85		-100		Unit
		Min.	Max.	Min.	Max.	Min.	Max.	
Read Cycle Time	TAVAV	70		85		100		ns
Address Access Time	TAVQV		70		85		100	ns
Chip Enable Access Time	TELQV		70		85		100	ns
Output Enable to Output Valid	TGLQV		40		45		50	ns
Chip Enable to Output in High Z	TEHQZ		30		30		35	ns
Chip Enable to Output in Low Z	TELQX	15		15		15		ns
Output Disable to Output in High Z	TGHQZ		25		25		35	ns
Output Enable to Output in Low Z	TGLQX	5		5		5		ns
Output Hold from Address Change	TAVQX	10		10			15	ns

Write Cycle

Item	Symbol	-70		-85		-100		Unit
		Min.	Max.	Min.	Max.	Min.	Max.	
Write Cycle Time	TAVAV	70		85		100		ns
Address Valid to End of Write	TAVWH	60		75		75		ns
Chip Enable to End of Write	TELWH	65		75		75		ns
	TWLEH	65		75		75		ns
Data to Write Time Overlap	TDVWH	30		30		40		ns
	TDVEH	30		30		40		ns
Data Hold Time from Write	TWHDX	0		0		0		ns
	TEHDX	0		0		0		ns
Write Pulse Width	TWLWH	50		60		70		ns
	TELEH	50		60		70		ns
Address Set-up Time	TAVWL	0		0		0		ns
	TAVEL	0		0		0		ns
Write Recovery Time	TWHAX	5		5		5		ns
	TEHAX	5		5		5		ns
Write to Output in High Z	TWLQZ		25		30		30	ns
Output Active from End of Write	TWHQX	5		5		10		ns

ELPAQ

ELPAQ

EMS256K8C

A division of ELMO Semiconductor Corp.

70 - 100ns

Timing Diagrams

Read Cycle Timing

Read Cycle 1: $\overline{CE}=\overline{OE}=\text{VIL}, \overline{WE}=\text{VIH}$

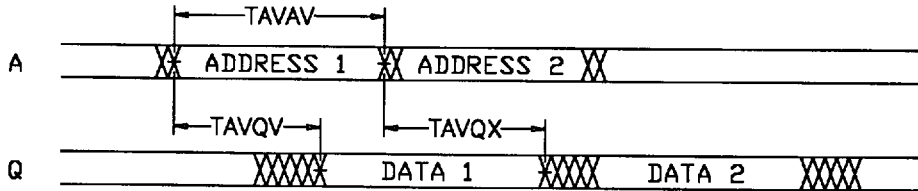

Read Cycle 2: $\overline{WE}=\text{VIH}$

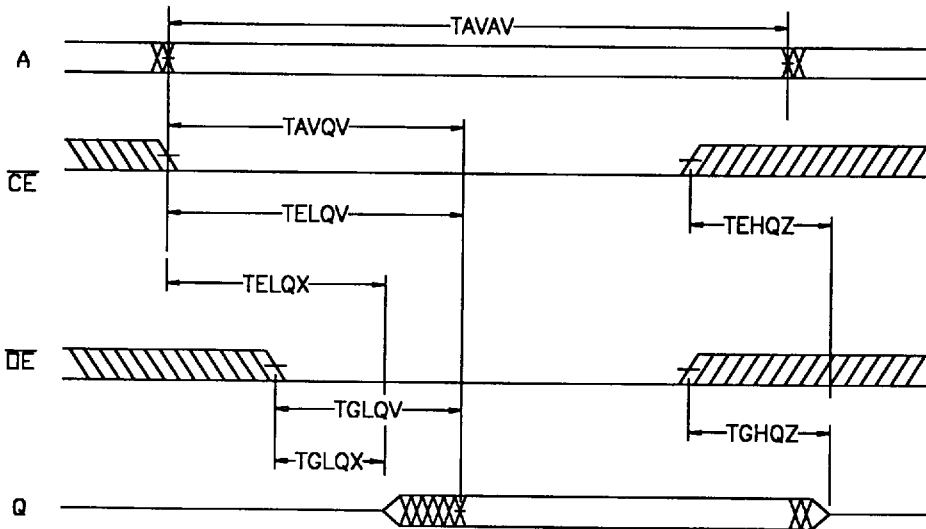

Write Cycle Timing

Write Cycle 1: \overline{WE} Control

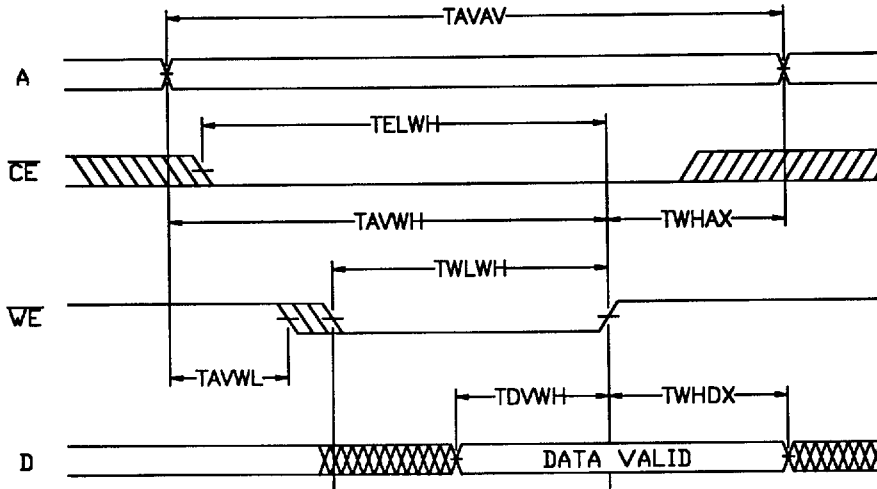

Write Cycle 2: \overline{CE} Control

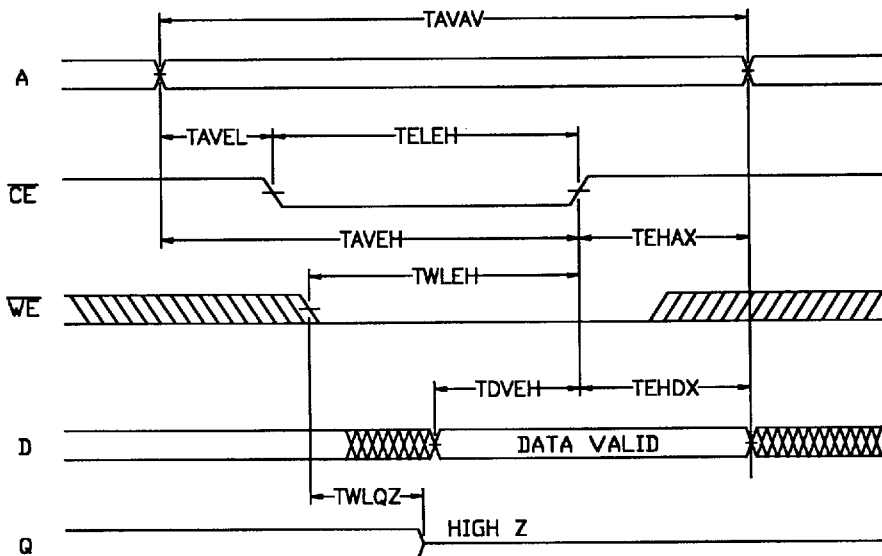

ELPAQ

ELPAQ

EMS256K8C

A division of ELMO Semiconductor Corp.

70 - 100ns

NOTES:

ORDERING INFORMATION

EMS256K8C

MO2

-70

C

Temperature Range

- C = Commercial (0 - 70°C)
- I = Industrial (-40 - +85°C)
- D = MIL Temp (-55 - +125°C)
- M = MIL Screen (-55 - +125°C)

Speed

- 70 = 70ns Access Time
- 85 = 85ns Access Time
- 100 = 100ns Access Time

Package

- MO2 = .600" 32 Lead Ceramic DIP
- MO6 = .600" 32 Lead Plastic DIP