

Ferranti

STROBOSCOPIC LIGHT SOURCE

A xenon filled cold cathode arc discharge tube designed for use in stroboscopic applications at frequencies up to 400 c/s. It emits a white light.

EN55

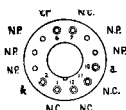

Underside View of base

PHYSICAL DETAILS.

Base	B12A (Duodecal).
Max. Seated Height	127 mm. (5 in.).
Max. Overall Length	140 mm. (5½ in.).
Max. Diameter (over base)	37 mm. (1½ in.).
Mounting Position	Any.

BASE CONNECTIONS.

Pin 1—No Connection.	Pin 7—No Connection.
Pin 2—Cathode.	Pin 8—No Pin.
Pin 3—No Pin.	Pin 9—No Pin.
Pin 4—No Pin.	Pin 10—Anode.
Pin 5—No Pin.	Pin 11—No Connection.
Pin 6—Trigger.	Pin 12—No Connection.

RATINGS.

(All maximum ratings are 'absolute').

Max. Anode Voltage (D.C. Static)	...	1000 volts.
Max. Anode Voltage (working)	...	900 volts.
Min. Anode Voltage (working)	...	700 volts.
*Max. Dissipation	...	20 watts.
Max. Discharge Capacitor	...	6 μ F.
†Min. Charging Resistor (12–150 c/s)	...	8 k Ω
	(150–400 c/s)	11 k Ω
Max. Operating Frequency	...	400 c/s.

CHARACTERISTICS.

‡*Trigger Voltage	2 to 4 kV.
§Typical Peak Luminous Intensity	140,000 Candelas.
§Typical Flash Duration at ½ peak	25 to 30 μ sec.

For Peak Luminous Intensity and Flash Duration for other operating conditions see graphs on Pages 4 and 5.

*See Notes on Operation—Page 6.

†For stroboscopic operation these resistors should be rated for 25W. dissipation.

‡Peak pulse voltage.

§ $V_a = 900$ C = 6 μ F.

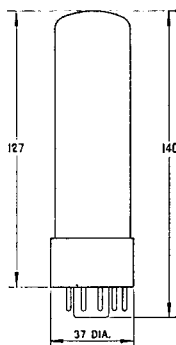

TYPICAL OPERATION.

For repetitive flashing operation the following circuits are suitable for use in conjunction with a variable frequency pulse generator to control the flash frequency.

For stroboscopic equipment the initiating controlled frequency pulse applied to the trigger of the EN10 or fed to the control grid of the EL81 in the circuits below may be derived from a multivibrator circuit (as described in the EN10 data sheet) or other hard valve pulse generator circuit.

- (1) For operation at frequencies from 5 to 250 c/s. The trigger pulse voltage may be satisfactorily derived from a trigger circuit using a 'NEOSTRON' type tube (EN10) as illustrated in Fig. 1. The controlled frequency pulse which is applied to the trigger electrode of the EN10 determines the flash frequency of the EN55. Further information on the operation of this circuit is contained in the EN10 data sheets.

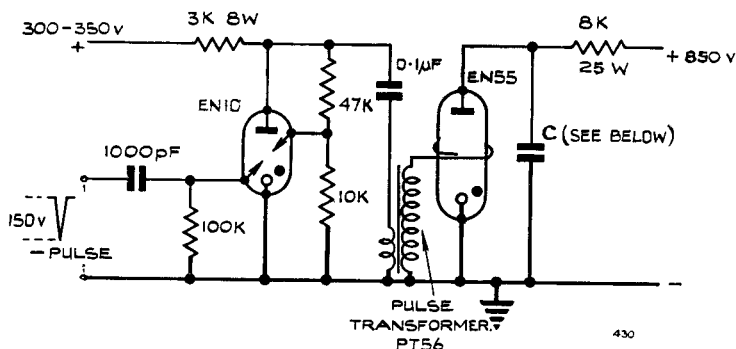

Fig. 1

Recommended values of C:—

5-25 c/s	3 μF.
25-50 c/s	1.5 μF.
50-150 c/s	0.75 μF.
150-250 c/s	0.5 μF.

- (2) For frequencies above 250 c/s it is desirable to use a hard valve trigger circuit. A suitable circuit is shown below (Fig. 2).

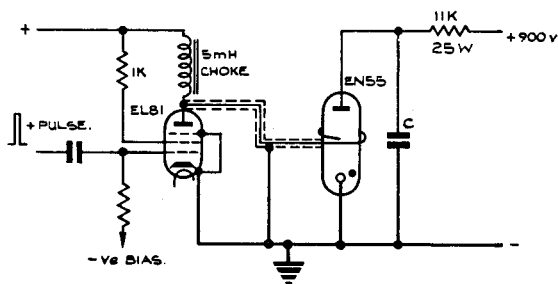

Fig. 2

Recommended values of C —

250-400 c/s	0.25 μF.
-------------	-----	-----	-----	-----	----------

A simple air cored or "ferrox" cored choke with an inductance of approximately 5 mH and adequate insulation will be suitable.

SPECTRAL CHARACTERISTICS

DISTRIBUTION OF LIGHT OUTPUT OVER THE VISIBLE SPECTRUM

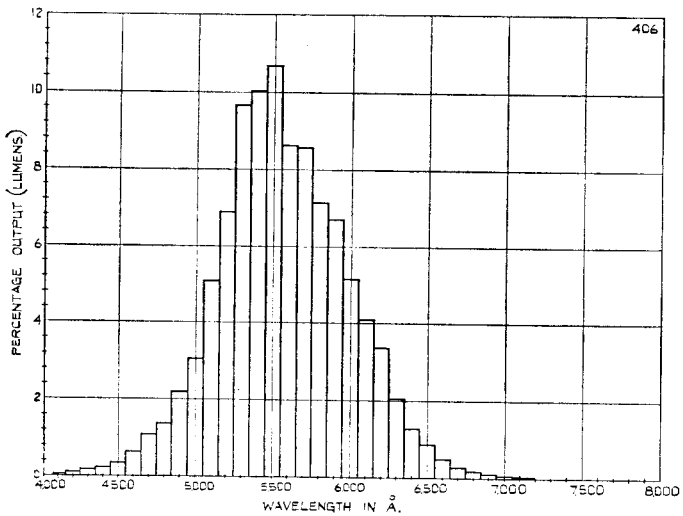

DISTRIBUTION OF RATE OF EMISSION OF ENERGY OVER THE VISIBLE SPECTRUM

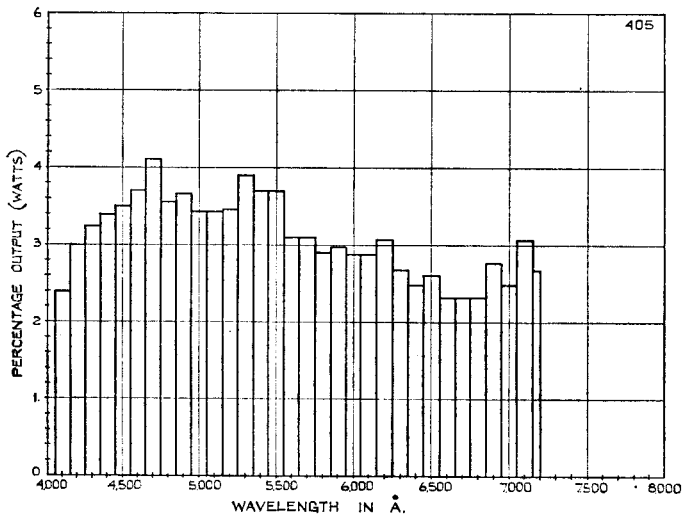

TYPICAL FLASH CHARACTERISTICS
at 50 flashes per sec.

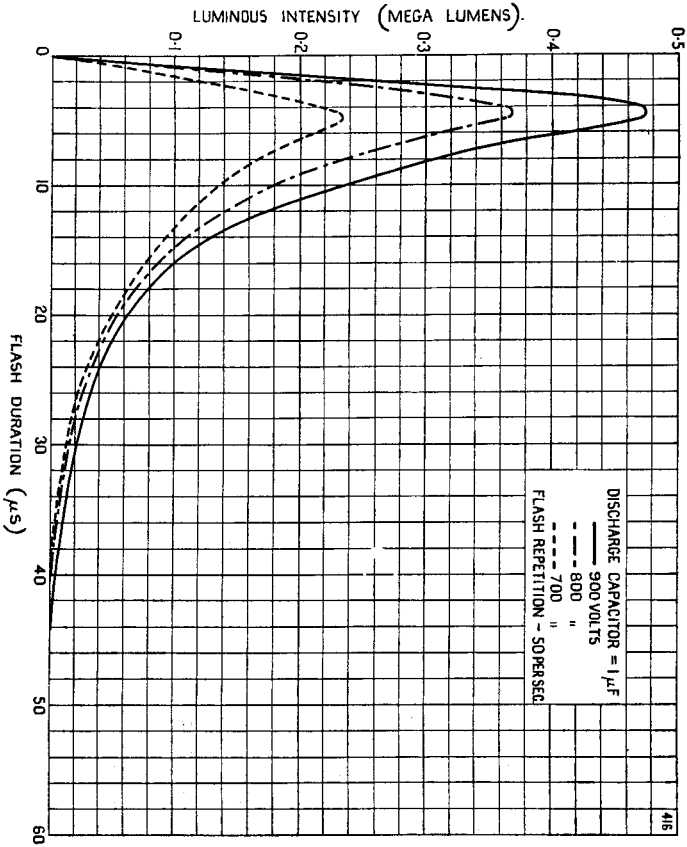

TYPICAL FLASH CHARACTERISTICS
Single Flash Operation

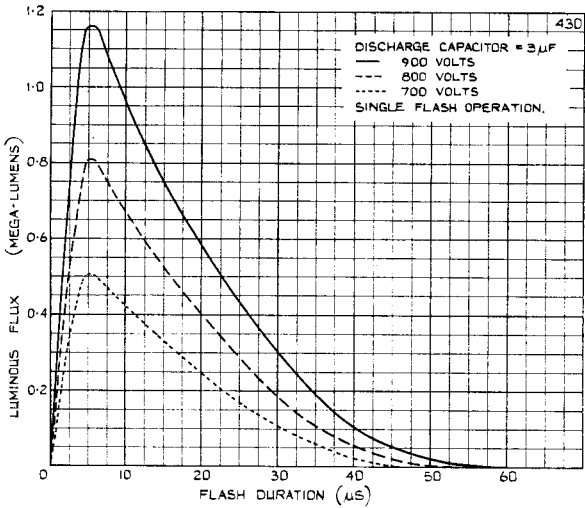
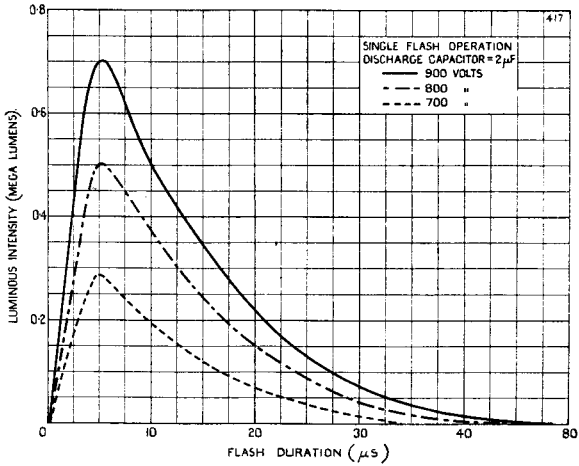

NOTES ON OPERATION.

Discharge Capacitor. Should be a good quality paper type with sufficient working voltage continuous rating preferably non-inductive and designed for high current pulse operation.

Discharge Energy. It is important to ensure that the energy dissipated in the tube does not exceed the maximum rating given on page 1. Over-running the tube even for very short periods may cause permanent damage, resulting in erratic operation particularly at the higher frequencies, and/or shortened life.

Trigger Voltage. The trigger voltage is the peak pulse voltage.

Connecting Leads. Because of the very high peak current of the discharge all the leads in the discharge path connecting the capacitor with anode and cathode should be of heavy gauge and as short as possible in order to ensure the maximum discharge energy.

Flash Duration. The duration of the light flash with a 4 μ F. capacitor charged to 800 volts is approximately 15-20 microseconds at $\frac{1}{3}$ of the peak luminous intensity. Higher energy discharges will lengthen the duration of the discharge and lower energy discharges are shorter. (See graphs on Pages 4 and 5).

WARNING. The use of high voltages and capacitances constitutes a hazard and care should be taken in operating or repairing any equipment incorporating these tubes.