



Micro Commercial Components
 21201 Itasca Street Chatsworth
 CA 91311
 Phone: (818) 701-4933
 Fax: (818) 701-4939

ER3AB THRU ER3JB

Features

- For Surface Mount Applications
- Extremely Low Thermal Resistance
- Easy Pick And Place
- High Temp Soldering: 250°C for 10 Seconds At Terminals\
- Super Fast Recovery Times For High Efficiency

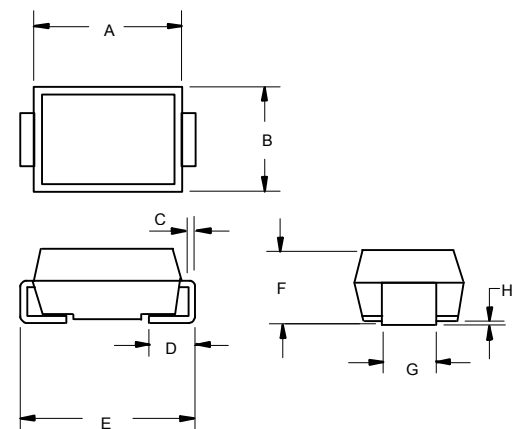
3 Amp Super Fast Recovery Silicon Rectifier 50 to 600 Volts

Maximum Ratings

- Operating Temperature: -50°C to +150°C
- Storage Temperature: -50°C to +150°C
- Maximum Thermal Resistance; 16°C/W Junction To Lead

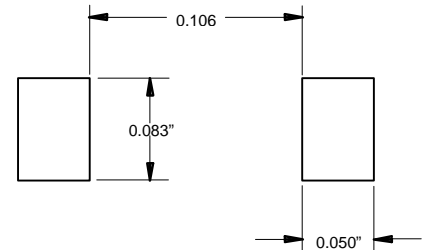
MCC Catalog Number	Device Marking	Maximum Recurrent Peak Reverse Voltage	Maximum RMS Voltage	Maximum DC Blocking Voltage
ER3AB	ER3AB	50V	35V	50V
ER3BB	ER3BB	100V	70V	100V
ER3CB	ER3CB	150V	105V	150V
ER3DB	ER3DB	200V	140V	200V
ER3GB	ER3GB	400V	280V	400V
ER3JB	ER3JB	600V	420V	600V

DO-214AA (SMBJ) (LEAD FRAME)



DIM	DIMENSIONS				NOTE
	INCHES		MM		
A	.160	.185	4.06	4.70	
B	.130	.155	3.30	3.94	
C	.006	.012	0.15	0.31	
D	.030	.060	0.76	1.52	
E	.200	.220	5.08	5.59	
F	.079	.103	2.01	2.62	
G	.075	.087	1.91	2.21	
H	.002	.008	0.05	0.203	

SUGGESTED SOLDER PAD LAYOUT



Electrical Characteristics @ 25°C Unless Otherwise Specified

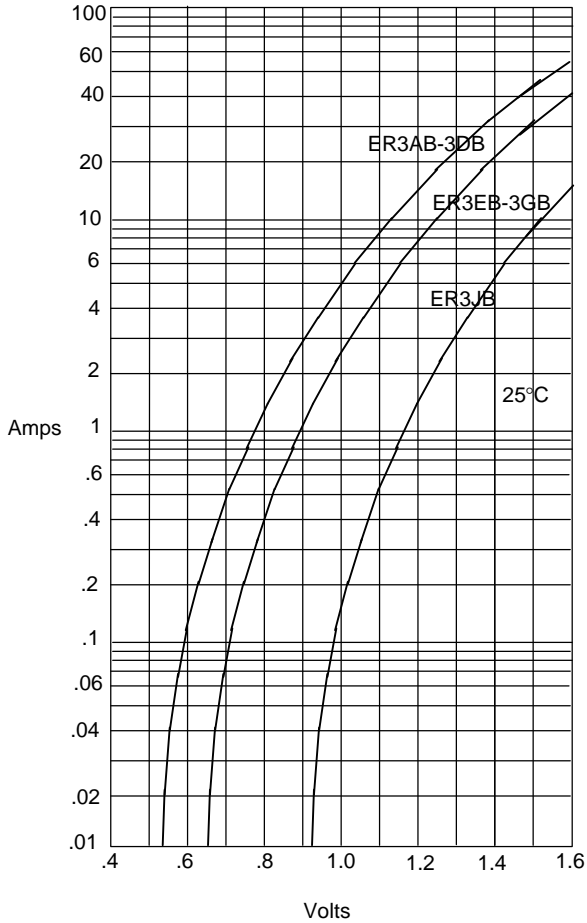
Average Forward Current	$I_{F(AV)}$	3.0A	$T_L = 75^\circ\text{C}$
Peak Forward Surge Current	I_{FSM}	100A	8.3ms, half sine
Maximum Instantaneous Forward Voltage ER3AB-3DB ER3GB ER3JB	V_F	.95V 1.25V 1.70V	$I_{FM} = 3.0A;$ $T_J = 25^\circ\text{C}$
Maximum DC Reverse Current At Rated DC Blocking Voltage	I_R	5 μA 200 μA	$T_J = 25^\circ\text{C}$ $T_J = 100^\circ\text{C}$
Maximum Reverse Recovery Time	T_{rr}	35ns	$I_F=0.5A, I_R=1.0A,$ $I_{rr}=0.25A$
Typical Junction Capacitance	C_J	45pF	Measured at 1.0MHz, $V_R=4.0V$

*Pulse test: Pulse width 300 μsec , Duty cycle 2%

ER3AB thru ER3JB

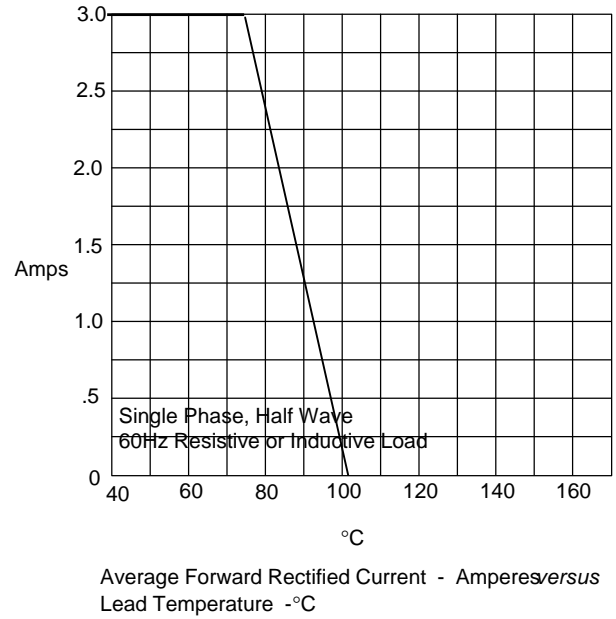


Figure 1
Typical Forward Characteristics



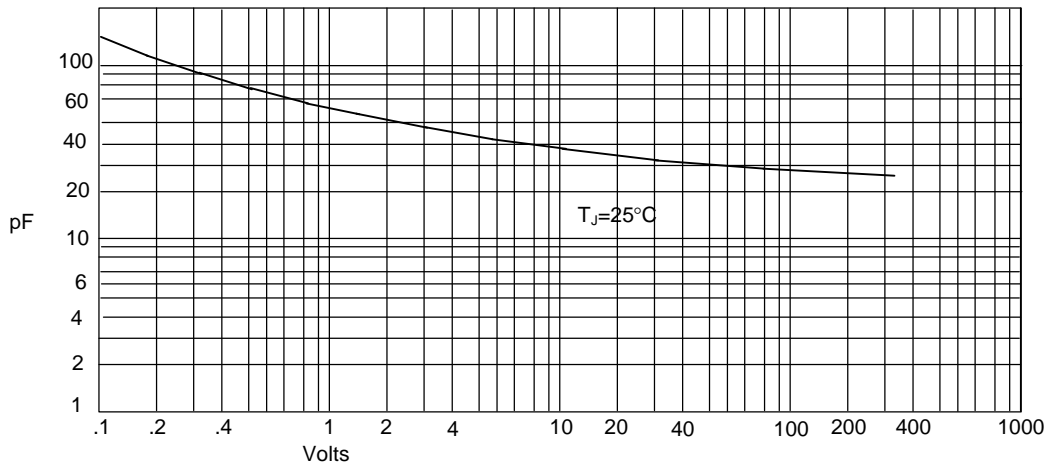
Instantaneous Forward Current - Amperes versus
Instantaneous Forward Voltage - Volts

Figure 2
Forward Derating Curve



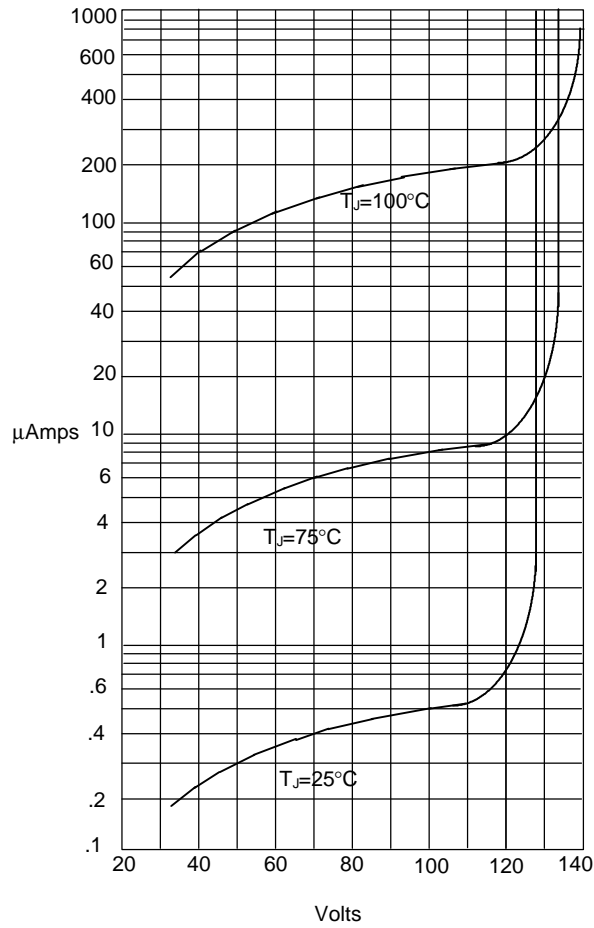
Average Forward Rectified Current - Amperes versus
Lead Temperature - °C

Figure 3
Junction Capacitance



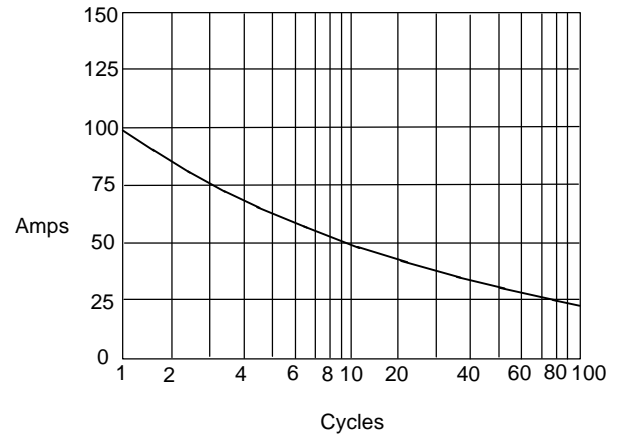
Junction Capacitance - pF versus
Reverse Voltage - Volts

Figure 4
Typical Reverse Characteristics



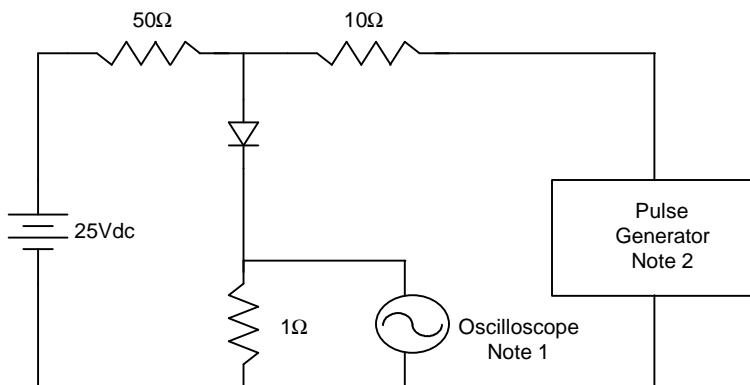
Instantaneous Reverse Leakage Current - MicroAmperes versus
Percent Of Rated Peak Reverse Voltage - Volts

Figure 5
Peak Forward Surge Current



Peak Forward Surge Current - Amperes versus
Number Of Cycles At 60Hz - Cycles

Figure 6
Reverse Recovery Time Characteristic And Test Circuit Diagram



- Notes:
1. Rise Time = 7ns max.
Input impedance = 1 megohm, 22pF
 2. Rise Time = 10ns max.
Source impedance = 50 ohms
 3. Resistors are non-inductive

