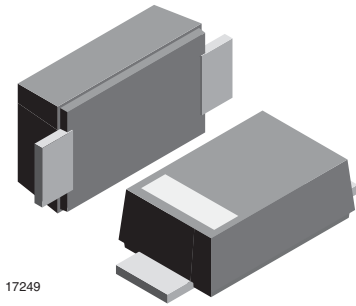


Ultrafast Rectifier Surface Mount



FEATURES

- For surface mounted applications
- Low profile package
- Ideal for automated placement
- Glass passivated pallet chip junction
- Meets MSL level 1, per J-STD-020, LF maximum peak of 260 °C
- Meets JESD 201 class 2 whisker test
- Wave and reflow solderable
- AEC-Q101 qualified
- Material categorization: for definitions of compliance please see www.vishay.com/doc?99912


RoHS
COMPLIANT

MECHANICAL DATA

Case: DO-219AB (SMF)

Polarity: band denotes cathode end

Weight: approx. 15 mg

Packaging codes / options:

GS18/10K per 13" reel (8 mm tape)

GS08/3K per 7" reel (8 mm tape)

Int. construction: single

PARTS TABLE			
PART	ORDERING CODE	MARKING	REMARKS
ES07B	ES07B-GS18 or ES07B-GS08	EB	Tape and reel
ES07D	ES07D-GS18 or ES07D-GS08	ED	Tape and reel

ABSOLUTE MAXIMUM RATINGS ($T_{amb} = 25\text{ }^{\circ}\text{C}$, unless otherwise specified)					
PARAMETER	TEST CONDITION	PART	SYMBOL	VALUE	UNIT
Maximum repetitive peak reverse voltage		ES07B	V_{RRM}	100	V
		ES07D	V_{RRM}	200	V
Maximum RMS voltage		ES07B	V_{RMS}	70	V
		ES07D	V_{RMS}	140	V
Maximum DC blocking voltage		ES07B	V_{DC}	100	V
		ES07D	V_{DC}	200	V
Maximum average forward rectified current	$T_{tp} = 109\text{ }^{\circ}\text{C}$		$I_{F(AV)}$	1.2	A
	$T_A = 65\text{ }^{\circ}\text{C}$ ⁽¹⁾		$I_{F(AV)}$	0.5	A
Peak forward surge current 8.3 ms single half sine-wave	$T_L = 25\text{ }^{\circ}\text{C}$		I_{FSM}	30	A

Note
⁽¹⁾ Mounted on epoxy glass PCB with 3 mm x 3 mm Cu pads ($\geq 40\text{ }\mu\text{m}$ thick)

THERMAL CHARACTERISTICS ($T_{amb} = 25\text{ }^{\circ}\text{C}$, unless otherwise specified)				
PARAMETER	TEST CONDITION	SYMBOL	VALUE	UNIT
Thermal resistance junction to ambient air ⁽¹⁾		R_{thJA}	180	K/W
Operating junction and storage temperature range		T_j, T_{stg}	-55 to 150	$^{\circ}\text{C}$

Note
⁽¹⁾ Mounted on epoxy glass PCB with 3 mm x 3 mm Cu pads ($\geq 40\text{ }\mu\text{m}$ thick)

ELECTRICAL CHARACTERISTICS ($T_{amb} = 25\text{ }^{\circ}\text{C}$, unless otherwise specified)							
PARAMETER	TEST CONDITION	PART	SYMBOL	MIN.	TYP.	MAX.	UNIT
Instantaneous forward voltage	$I_F = 1\text{ A}$ ⁽¹⁾	ES07B	V_F			0.98	V
		ES07D	V_F			0.98	V
Maximum DC reverse current at rated DC blocking voltage	$T_A = 25\text{ }^{\circ}\text{C}$	ES07B	I_R			10	μA
		ES07D	I_R			10	μA
	$T_A = 100\text{ }^{\circ}\text{C}$	ES07B	I_R			50	μA
		ES07D	I_R			50	μA
Reverse recovery time	$I_F = 0.5\text{ A}$, $I_R = 1\text{ A}$, $I_{rr} = 0.25\text{ A}$	ES07B	t_{rr}			25	ns
		ES07D	t_{rr}			25	ns
Typical capacitance	4 V, 1 MHz	ES07B	C_j		4		pF
		ES07D	C_j		4		pF

Note

(1) Pulse test: 300 μs pulse width, 1 % duty cycle

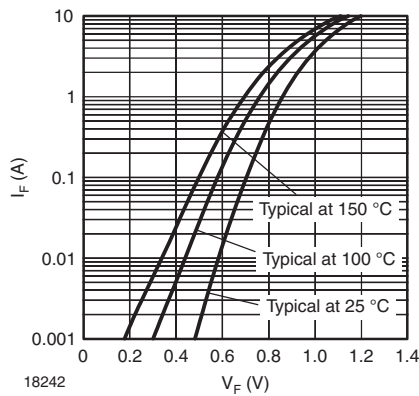
TYPICAL CHARACTERISTICS ($T_{amb} = 25\text{ }^{\circ}\text{C}$, unless otherwise specified)


Fig. 1 - Typical Forward Characteristics

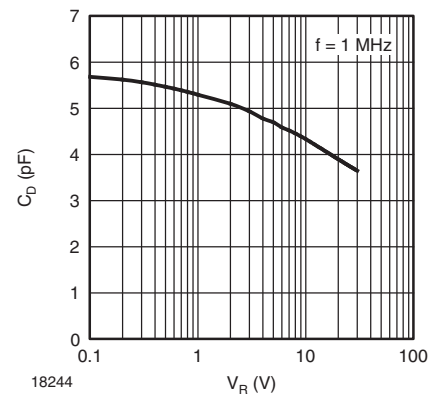


Fig. 3 - Typical Diode Capacitance vs. Reverse Voltage

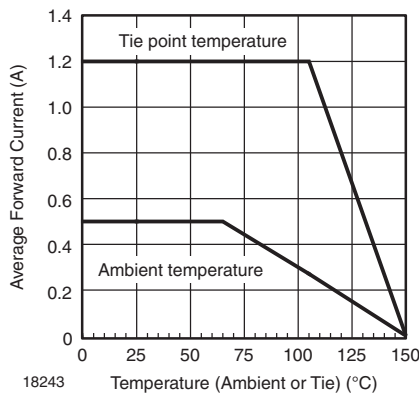


Fig. 2 - Forward Current Derating Curve

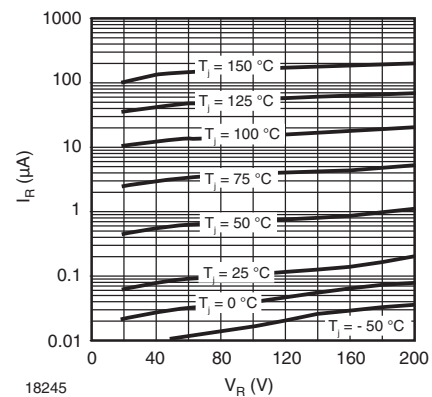
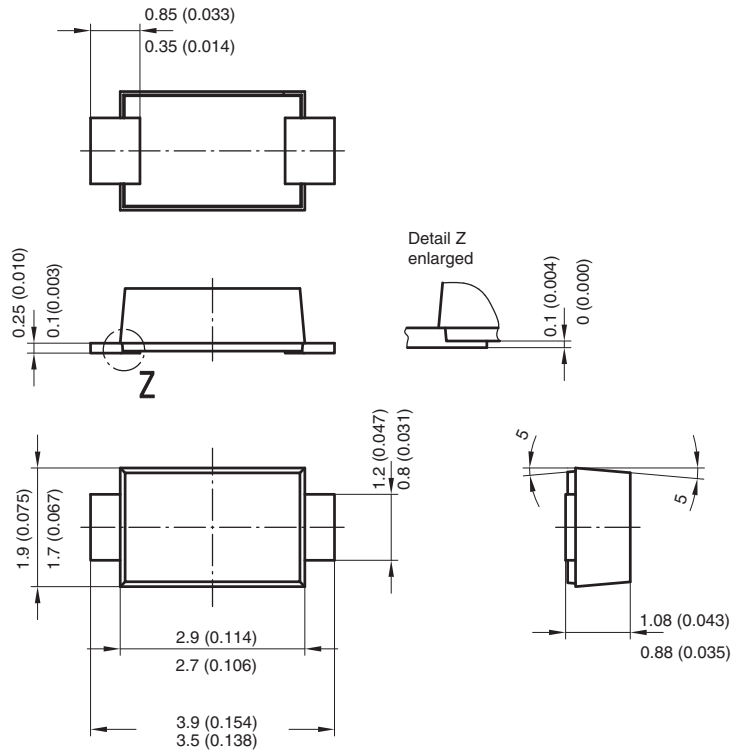


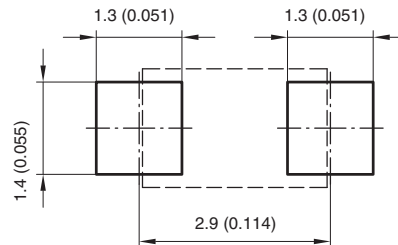
Fig. 4 - Typical Reverse Characteristics



PACKAGE DIMENSIONS in millimeters (inches): **DO-219AB (SMF)**



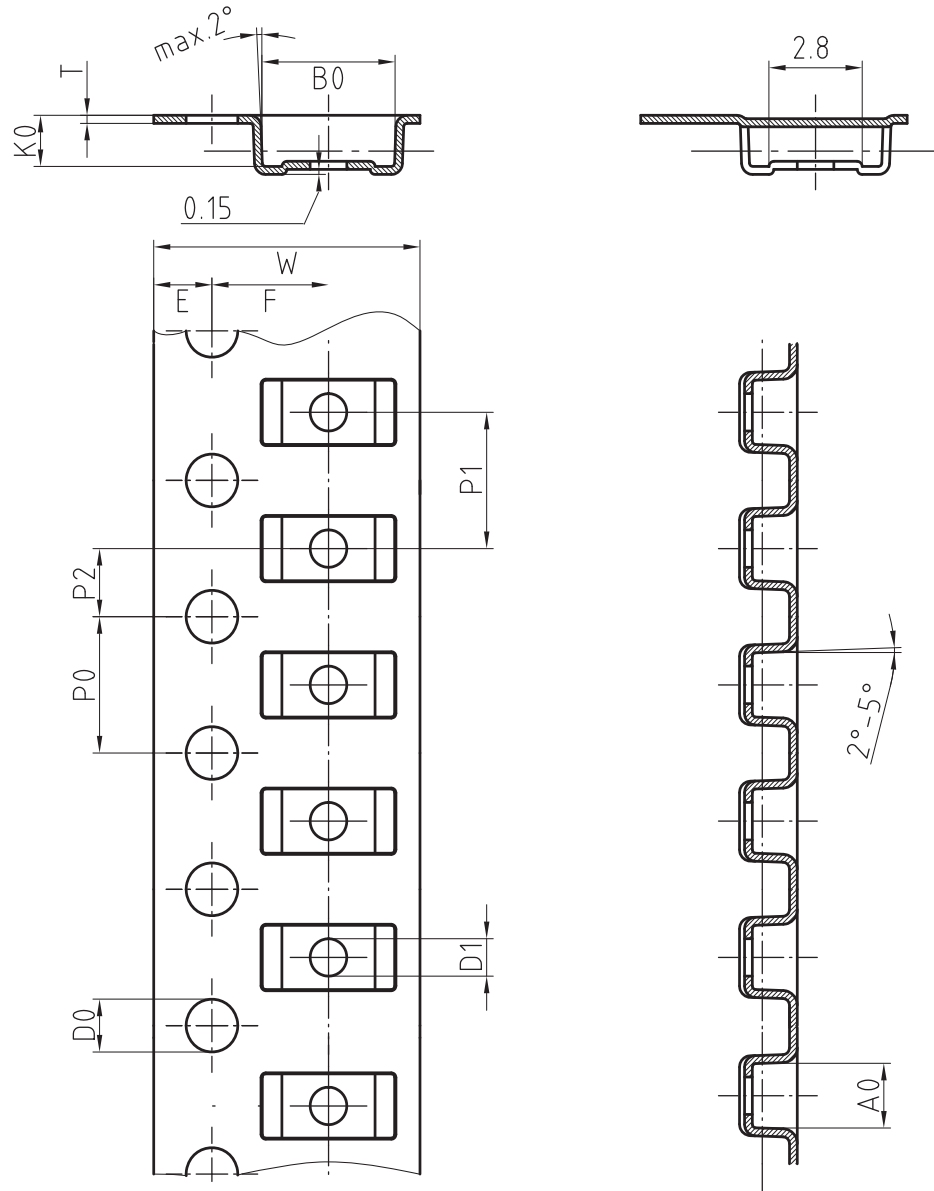
Foot print recommendation:



Created - Date: 15. February 2005
 Rev. 3 - Date: 13. March 2007
 Document no.:S8-V-3915.01-001 (4)
 17247



BLISTERTAPE DIMENSIONS in millimeters: **DO-219 AB (SMF)**



Mat:	A0	B0	K0	W	T	P0	P2	P1	D0	D1	E	F
PS	1.9	4.0	1.5	8.0	0.235	4.0	2.0	4.0	1.5	1	1.75	3.5

Document-No.: S8-V-3717.02-001 (3)

18513



Disclaimer

ALL PRODUCT, PRODUCT SPECIFICATIONS AND DATA ARE SUBJECT TO CHANGE WITHOUT NOTICE TO IMPROVE RELIABILITY, FUNCTION OR DESIGN OR OTHERWISE.

Vishay Intertechnology, Inc., its affiliates, agents, and employees, and all persons acting on its or their behalf (collectively, "Vishay"), disclaim any and all liability for any errors, inaccuracies or incompleteness contained in any datasheet or in any other disclosure relating to any product.

Vishay makes no warranty, representation or guarantee regarding the suitability of the products for any particular purpose or the continuing production of any product. To the maximum extent permitted by applicable law, Vishay disclaims (i) any and all liability arising out of the application or use of any product, (ii) any and all liability, including without limitation special, consequential or incidental damages, and (iii) any and all implied warranties, including warranties of fitness for particular purpose, non-infringement and merchantability.

Statements regarding the suitability of products for certain types of applications are based on Vishay's knowledge of typical requirements that are often placed on Vishay products in generic applications. Such statements are not binding statements about the suitability of products for a particular application. It is the customer's responsibility to validate that a particular product with the properties described in the product specification is suitable for use in a particular application. Parameters provided in datasheets and/or specifications may vary in different applications and performance may vary over time. All operating parameters, including typical parameters, must be validated for each customer application by the customer's technical experts. Product specifications do not expand or otherwise modify Vishay's terms and conditions of purchase, including but not limited to the warranty expressed therein.

Except as expressly indicated in writing, Vishay products are not designed for use in medical, life-saving, or life-sustaining applications or for any other application in which the failure of the Vishay product could result in personal injury or death. Customers using or selling Vishay products not expressly indicated for use in such applications do so at their own risk. Please contact authorized Vishay personnel to obtain written terms and conditions regarding products designed for such applications.

No license, express or implied, by estoppel or otherwise, to any intellectual property rights is granted by this document or by any conduct of Vishay. Product names and markings noted herein may be trademarks of their respective owners.

Material Category Policy

Vishay Intertechnology, Inc. hereby certifies that all its products that are identified as RoHS-Compliant fulfill the definitions and restrictions defined under Directive 2011/65/EU of The European Parliament and of the Council of June 8, 2011 on the restriction of the use of certain hazardous substances in electrical and electronic equipment (EEE) - recast, unless otherwise specified as non-compliant.

Please note that some Vishay documentation may still make reference to RoHS Directive 2002/95/EC. We confirm that all the products identified as being compliant to Directive 2002/95/EC conform to Directive 2011/65/EU.

Vishay Intertechnology, Inc. hereby certifies that all its products that are identified as Halogen-Free follow Halogen-Free requirements as per JEDEC JS709A standards. Please note that some Vishay documentation may still make reference to the IEC 61249-2-21 definition. We confirm that all the products identified as being compliant to IEC 61249-2-21 conform to JEDEC JS709A standards.