



ES3AB THRU ES3JB

SURFACE MOUNT SUPER FAST RECTIFIER

Reverse Voltage - 50 to 600 Volts Forward Current - 3.0 Ampere

FEATURES

- The plastic package carries Underwriters Laboratory Flammability Classification 94V-0
- For surface mounted applications
- Super fast switching for high efficiency
- Low reverse leakage
- Built-in strain relief, ideal for automated placement
- High forward surge current capability
- High temperature soldering guaranteed:
250°C/10 seconds at terminals

MECHANICAL DATA

Case: JEDEC DO-214AA molded plastic body

Terminals: Solder plated, solderable per MIL-STD-750, Method 2026

Polarity: Color band denotes cathode end

Mounting Position: Any

Weight: 0.005 ounce, 0.138 grams

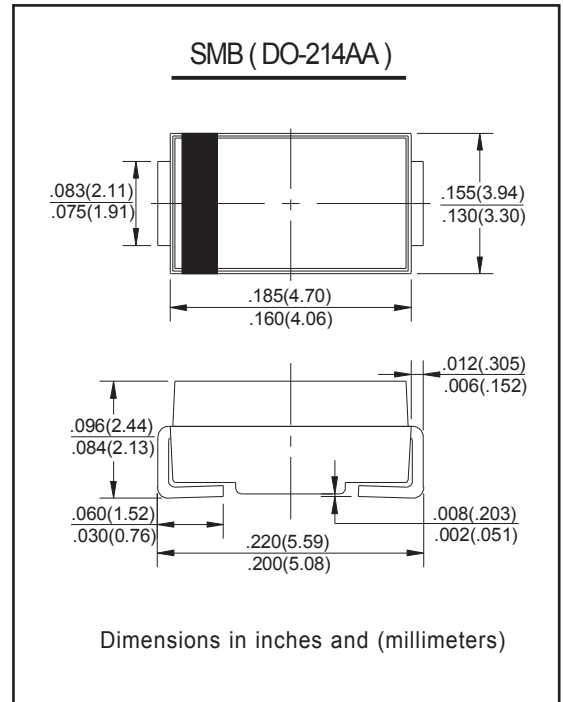

MAXIMUM RATINGS AND ELECTRICAL CHARACTERISTICS

Ratings at 25°C ambient temperature unless otherwise specified.
Single phase half-wave 60Hz, resistive or inductive load, for capacitive load current derate by 20%.

Characteristic	Symbol	ES3AB	ES3BB	ES3CB	ES3DB	ES3EB	ES3GB	ES3JB	Unit	
Peak Repetitive Reverse Voltage	V_{RRM}								V	
Working Peak Reverse Voltage	V_{RWM}	50	100	150	200	300	400	600		
DC Blocking Voltage	V_R									
RMS Reverse Voltage	$V_{R(RMS)}$	35	70	105	140	210	280	420	V	
Average Rectified Output Current @ $T_C = 100^\circ\text{C}$	I_o	3.0								A
Non-Repetitive Peak Forward Surge Current 8.3ms Single half sine-wave superimposed on rated load (JEDEC Method)	I_{FSM}	100								A
Forward Voltage @ $I_F = 3.0\text{A}$	V_{FM}	0.95				1.3		1.7	V	
Peak Reverse Current @ $T_A = 25^\circ\text{C}$ At Rated DC Blocking Voltage @ $T_A = 125^\circ\text{C}$	I_{RM}	10						500		μA
Reverse Recovery Time (Note 1)	t_{rr}	35								nS
Typical Junction Capacitance (Note 2)	C_j	45								pF
Operating and Storage Temperature Range	T_j, T_{STG}	-55 to +150								$^\circ\text{C}$

Note: 1. Measured with $I_F = 0.5\text{A}$, $I_R = 1.0\text{A}$, $IRR = 0.25\text{A}$.
2. Measured at 1.0 MHz and applied reverse voltage of 4.0V D.C.



ES3AB THRU ES3JB

RATINGS AND CHARACTERISTIC CURVES

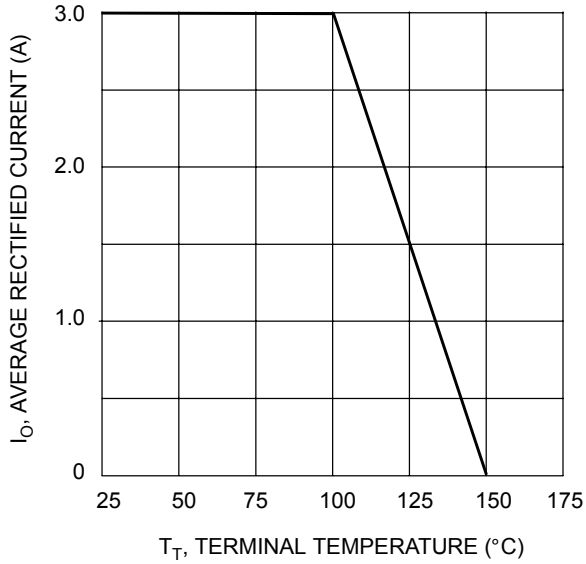

Fig. 1 Forward Current Derating Curve

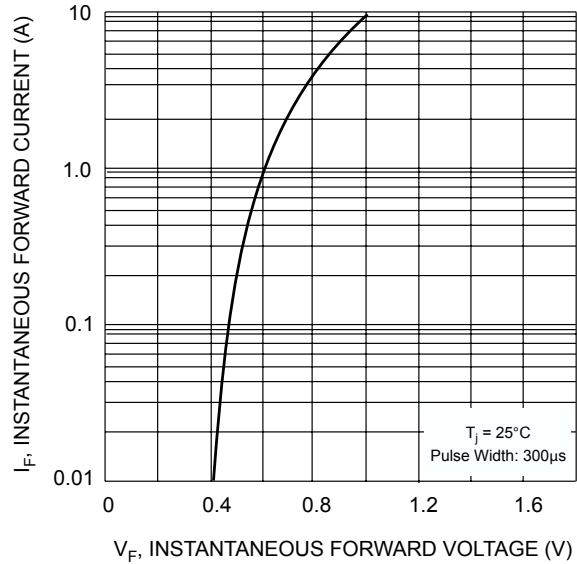

Fig. 2 Typical Forward Characteristics

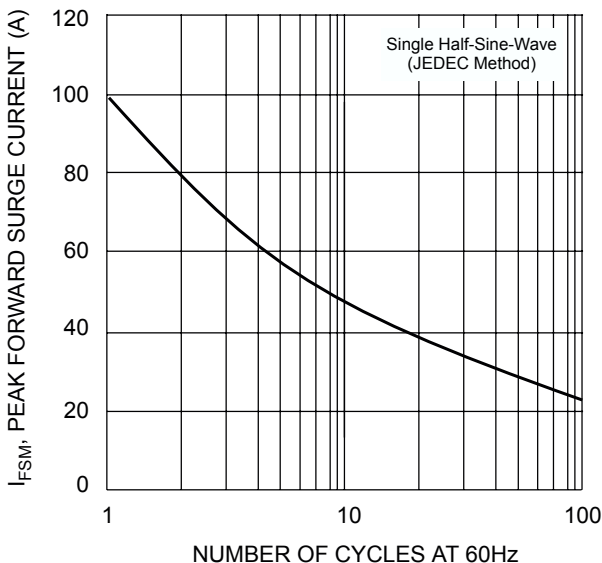

Fig. 3 Surge Current Derating Curve

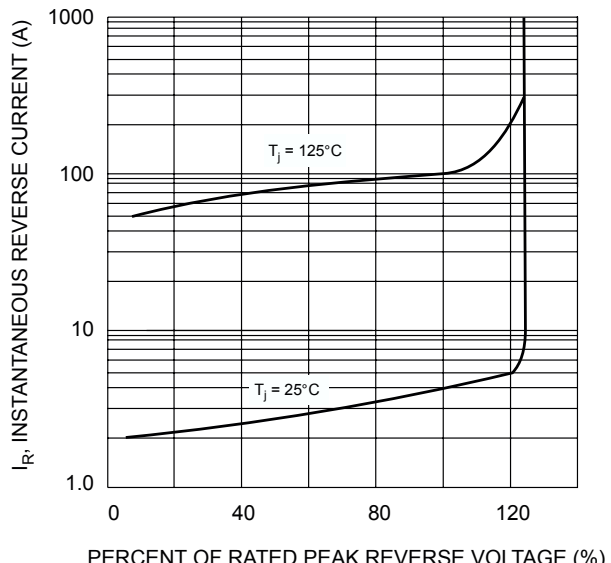
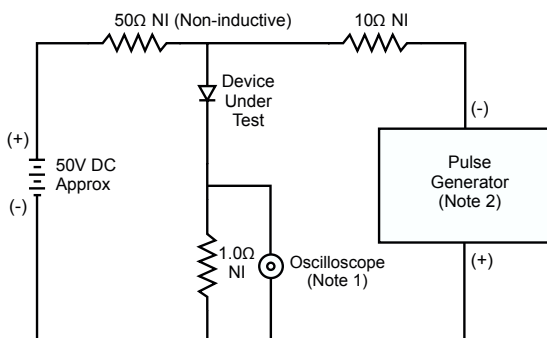

Fig. 4 Typical Reverse Characteristics



- Notes:
1. Rise Time = 7.0ns max. Input Impedance = 1.0M Ω , 22pF.
 2. Rise Time = 10ns max. Input Impedance = 50 Ω .

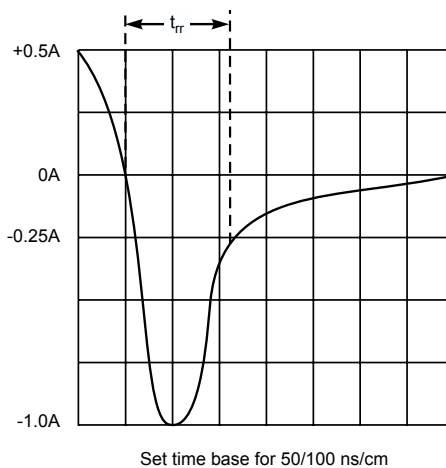

Fig. 5 Reverse Recovery Time Characteristic and Test Circuit