

# ESAD39M(C,N,D) (10A) (400V to 600V / 10A)

## FAST RECOVERY DIODE

### Features

- Insulated package by fully molding
- Super high speed switching
- Low VF in turn on
- High reliability

### Applications

- High speed power switching

### Maximum ratings and characteristics

- Absolute maximum ratings

Item	Symbol	Conditions	Rating		Unit
			-04	-06	
Repetitive peak reverse voltage	$V_{RRM}$		400	600	V
Non-repetitive peak reverse voltage	$V_{RSM}$		400	600	V
Isolating voltage	$V_{iso}$	Terminals-to-case, AC, 1min.	1500		V
Average output current	$I_o$	Square wave, duty=1/2, $T_c=85^\circ\text{C}$	10*		A
Surge current	$I_{FSM}$	Sine wave 10ms	50		A
Operating junction temperature	$T_j$		-40 to +150		$^\circ\text{C}$
Storage temperature	$T_{stg}$		-40 to +150		$^\circ\text{C}$

\* Average forward current of centertap full wave connection

- Electrical characteristics ( $T_a=25^\circ\text{C}$  Unless otherwise specified)

Item	Symbol	Conditions	Max.	Unit
Forward voltage drop	$V_{FM}$	$I_{FM}=4\text{A}$	2.5	V
Reverse current	$I_{RRM}$	$V_R=V_{RRM}$	100	$\mu\text{A}$
Reverse recovery time	$t_{rr}$	$I_F=0.1\text{A}$ , $I_R=0.2\text{A}$ , $I_{rec}=0.05\text{A}$	50	ns
Thermal resistance	$R_{th(j-c)}$	Junction to case	2.5	$^\circ\text{C/W}$

### Outline drawings, mm

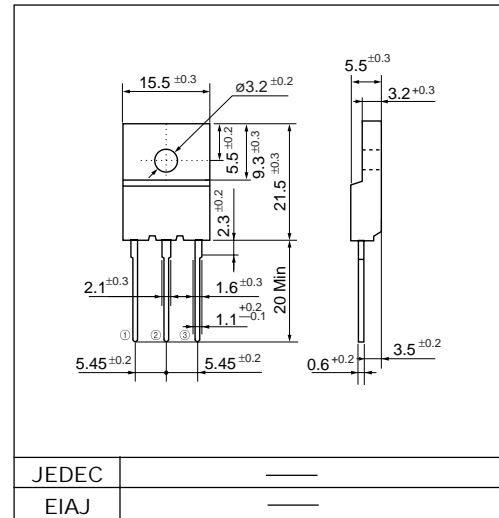

### Connection diagram

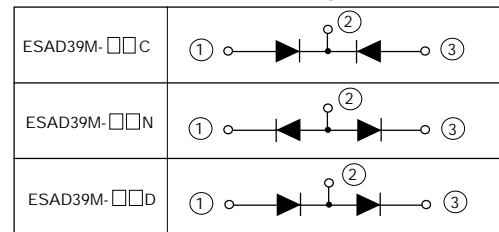

■ Characteristics

Forward characteristics

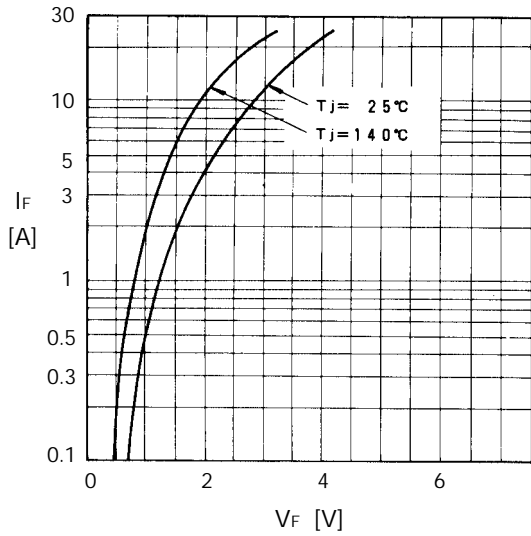

Reverse characteristics

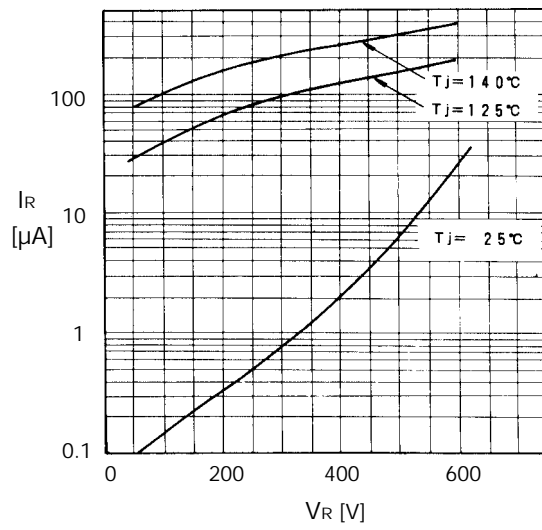

Forward power dissipation

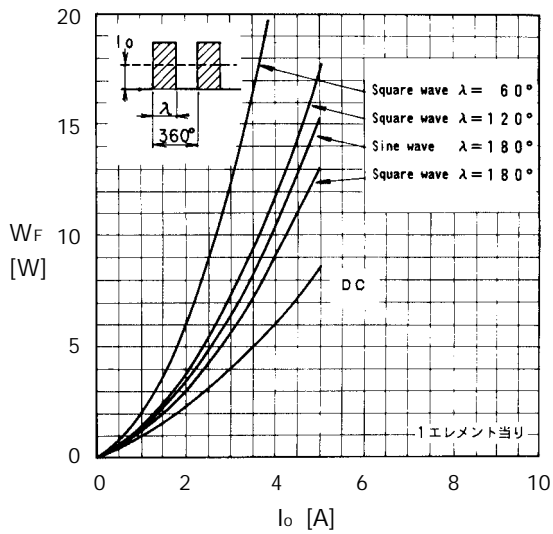

Output current-case temperature

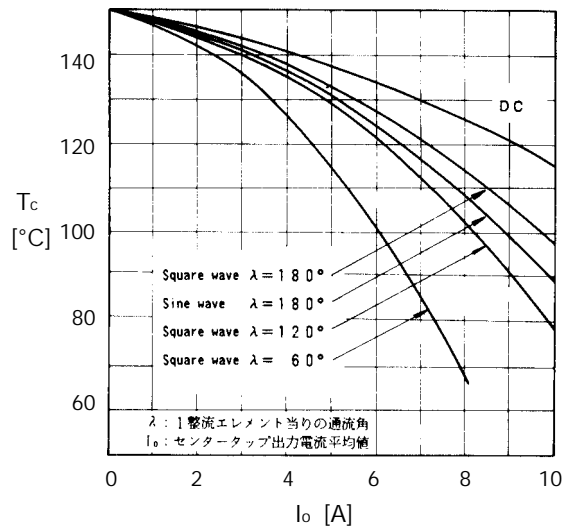

Junction capacitance characteristics

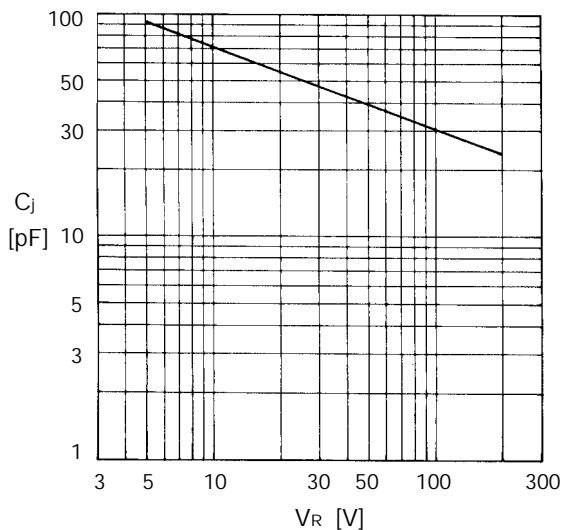

Surge capability

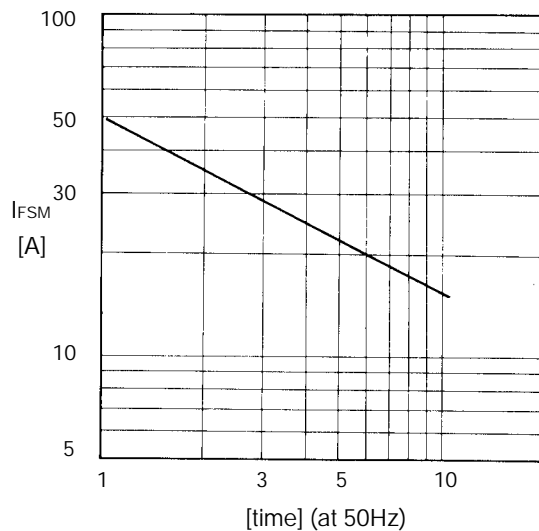

Transient thermal impedance

