



ESD0504/ESD0503

Low Capacitance TVS Array

General Description

ESD0504/ESD0503 are surge rated diode arrays designed to protect high speed data interfaces. This series has been specifically designed to protect sensitive components which are connected to data and transmission lines from overvoltage caused by ESD (electrostatic discharge), CDE (Cable Discharge Events), and EFT (electrical fast transients).

The unique design incorporates surge rated, low capacitance steering diodes and a TVS diode in a single package. During transient conditions, the steering diodes direct the transient to either the positive side of the power supply line or to ground. The internal TVS diode prevents over-voltage on the power line, protecting any downstream components. The low capacitance array configuration allows the user to protect four high-speed data or transmission lines. The low inductance construction minimizes voltage overshoot during high current surges.

Applications

- USB 2.0
- USB OTG
- Monitors and Flat Panel Displays
- Digital Visual Interface (DVI)
- High-Definition Multimedia Interface (HDMI)
- Gigabit Ethernet
- SIM Ports
- IEEE 1394 Firewire Ports

Features

- Array of surge rated diodes with internal TVS Diode
- Small package (2.4 x 2.2mm) saves board space
- Protects up to four I/O lines & power line
- Low capacitance (<3pF) for high-speed interfaces
- No insertion loss to 2.0GHz
- Low leakage current and clamping voltage
- Low operating voltage: 5.0V/3.3V
- Solid-state silicon-avalanche technology

IEC61000-4-2(ESD) 15kV(air), 8kV(Contact)

IEC61000-4-4(EFT) 40A(5/50ns)

IEC61000-4-5(Surge)24A(8/20us),Level2(Line-Ground)& Level 2(Line- Line)

Functional diagram



SOT23-6

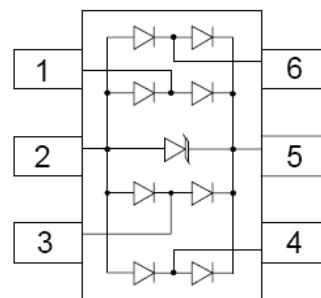

ESD0504/ESD0503

Absolute Ratings

Symbol	Parameter	Value	Units
P_{PK}	Peak Pulse Power ($t_p = 8/20\mu s$)	150	W
I_{PP}	Peak Pulse Current ($t_p = 8/20\mu s$)	6	A
T_J	Operating Temperature	-55 to +125	$^{\circ}C$
T_{stg}	Storage Temperature Range	-55 to +150	$^{\circ}C$

Electrical Characteristics

Part Numbers	V_{BR}			I_T	V_{RWM}	I_R	C
	Min.	Typ.	Max.				Typ. (Note1)
	V	V	V				pF
ESD0504	6.0	6.6	7.2	1	5	3	3
ESD0503	3.9	4.8	5.6	1	3.3	5	3

Note 1: I/O pins are pin 1, 3, 4, and 6

Typical Characteristics

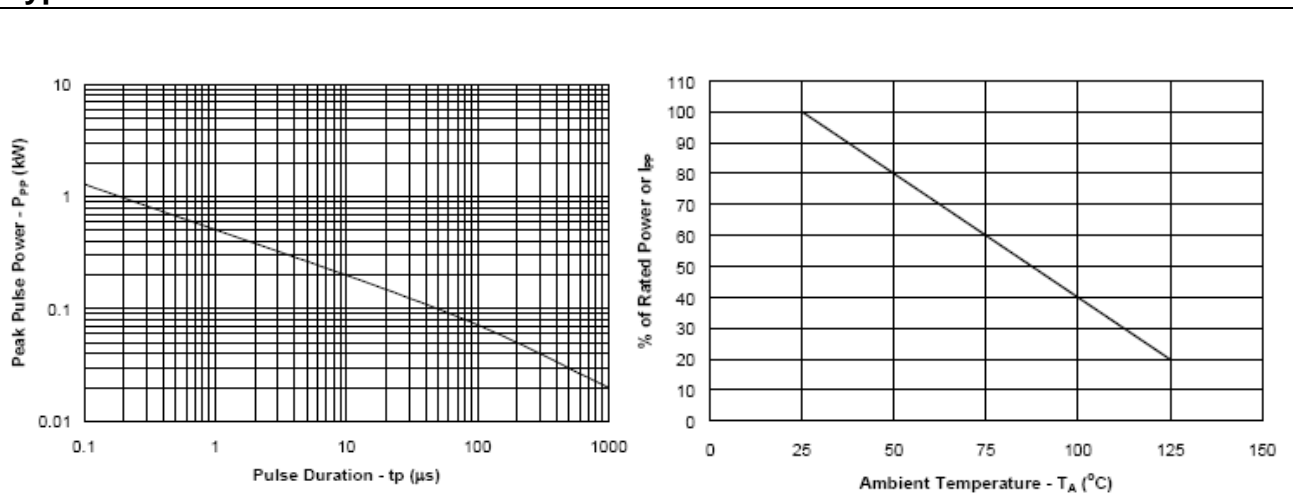

Fig1. Non-Repetitive Peak Pulse Power vs. Pulse Time

Fig2. Power Derating Curve

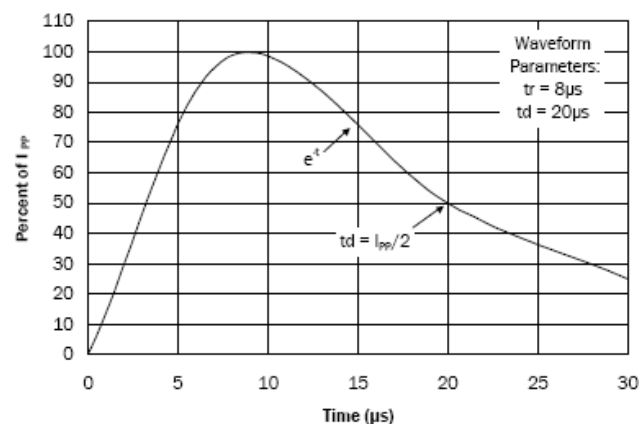

Fig3. Pulse Waveform

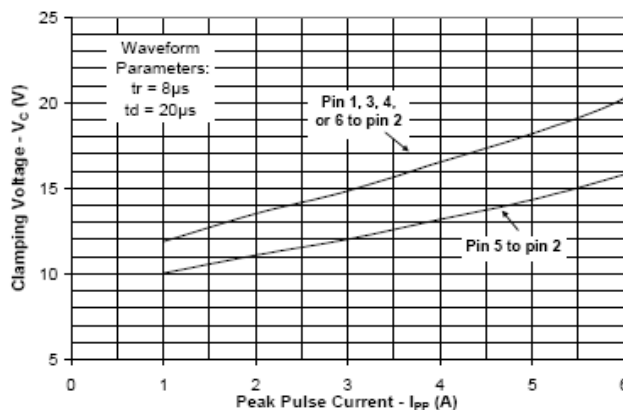

Fig4. Clamping Voltage vs. Peak Pulse Current

ESD0504/ESD0503

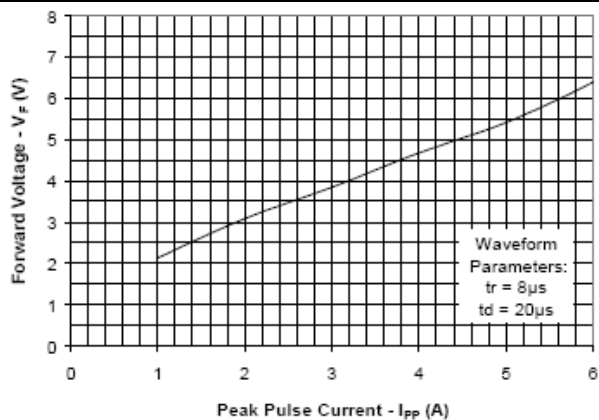

Fig5. Forward Voltage vs. peak Pulse Current

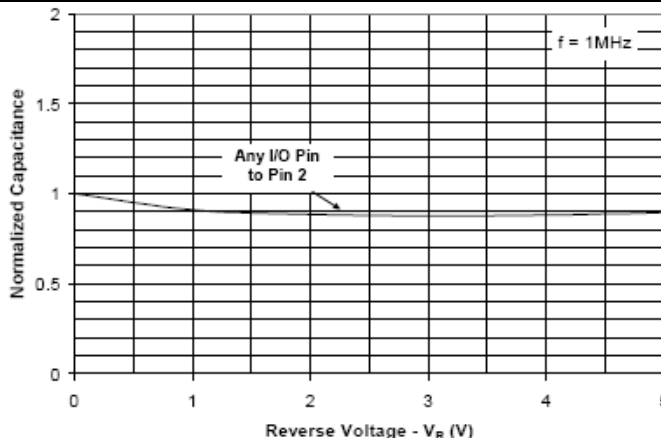
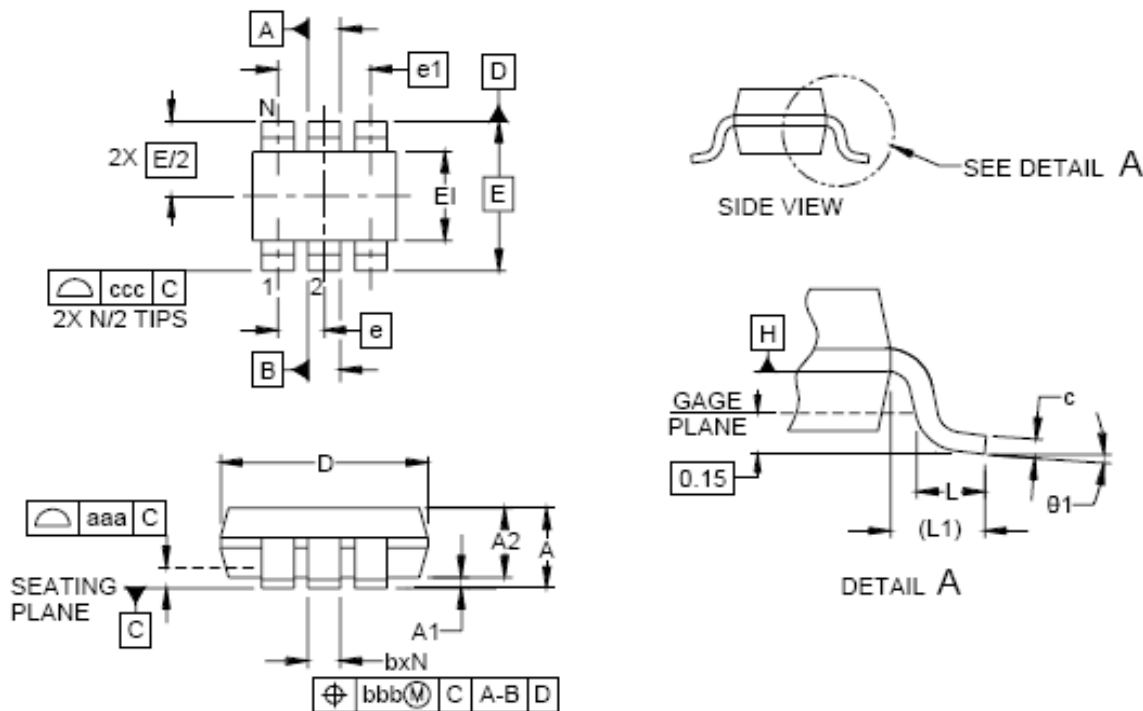

Fig6. Capacitance vs. Reverse Voltage (Normalized to 0V)

SOT23-6 Mechanical Data



NOTES:

1. CONTROLLING DIMENSIONS ARE IN MILLIMETERS(ANGLES IN DEGREES).
2. DATUMS -A- AND -B- TO BE DETERMINED AT DATUM PLANE -H-.
3. DIMENSIONS "E1" AND "D" DO NOT INCLUDE MOLD FLASH, PROTRUSIONS OR GATE BURRS.
4. REFERENCE JEDEC STD MO-203, VARIATION AB

ESD0504/ESD0503

DIMENSIONS						
DIM	INCHES			MILLIMETERS		
	MIN	NOM	MAX	MIN	NOM	MAX
A	-	-	.043	-	-	1.10
A1	.000	-	.004	.000	-	0.10
A2	.028	.035	.039	0.70	0.90	1.00
b	.006	-	.012	0.15	-	0.30
c	.003	-	.009	0.08	-	0.22
D	.075	.079	.083	1.90	2.00	2.10
E1	.045	.049	.053	1.15	1.25	1.35
E	.083 BSC			2.10 BSC		
e	.026 BSC			0.65 BSC		
e1	.051			1.30 BSC		
L	.010	.014	.018	0.26	0.36	0.46
L1	(.017)			(0.42)		
N	6			6		
θ1	0°	-	8°	0°	-	8°
aaa	.004			0.10		
bbb	.004			0.10		
ccc	.012			0.30		