

3.3V ESD Protection Diodes

Ultra Low Capacitance ESD Protection Diode for High Speed Data Line

ESDL1531

The ESDL1531 ESD protection diodes are designed to protect high speed data lines from ESD. Ultra-low capacitance and low ESD clamping voltage make this device an ideal solution for protecting voltage sensitive high speed data lines.

Features

- Low Capacitance (0.15 pF Typ, I/O to GND)
- Protection for the Following IEC Standards:
IEC 61000-4-2 (Level 4)
- Low ESD Clamping Voltage
- These Devices are Pb-Free, Halogen Free/BFR Free and are RoHS Compliant

Typical Applications

- USB 2.0/3.x
- Thunderbolt
- MHL 2.0
- eSATA

MAXIMUM RATINGS (T_J = 25°C unless otherwise noted)

Rating	Symbol	Value	Unit
Operating Junction Temperature Range	T _J	-55 to +150	°C
Storage Temperature Range	T _{stg}	-55 to +150	°C
Lead Solder Temperature – Maximum (10 Seconds)	T _L	260	°C
IEC 61000-4-2 Contact IEC 61000-4-2 Air	ESD	±30 ±30	kV kV

Stresses exceeding those listed in the Maximum Ratings table may damage the device. If any of these limits are exceeded, device functionality should not be assumed, damage may occur and reliability may be affected.

See Application Note AND8308/D for further description of survivability specs.

MARKING DIAGRAM



ESDL1531
X4DFN2 (01005)
CASE 718AA



J = Device Code
M = Date Code

PIN CONFIGURATION AND SCHEMATIC

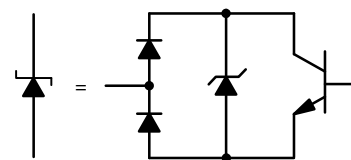
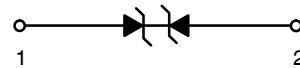

ORDERING INFORMATION

See detailed ordering and shipping information on page 5 of this data sheet.

ELECTRICAL CHARACTERISTICS

(T_A = 25°C unless otherwise noted)

Symbol	Parameter
V _{RWM}	Working Peak Voltage
I _R	Maximum Reverse Leakage Current @ V _{RWM}
V _{BR}	Breakdown Voltage @ I _T
I _T	Test Current
V _{HOLD}	Holding Reverse Voltage
I _{HOLD}	Holding Reverse Current
R _{DYN}	Dynamic Resistance
I _{PP}	Maximum Peak Pulse Current
V _C	Clamping Voltage @ I _{PP} V _C = V _{HOLD} + (I _{PP} * R _{DYN})

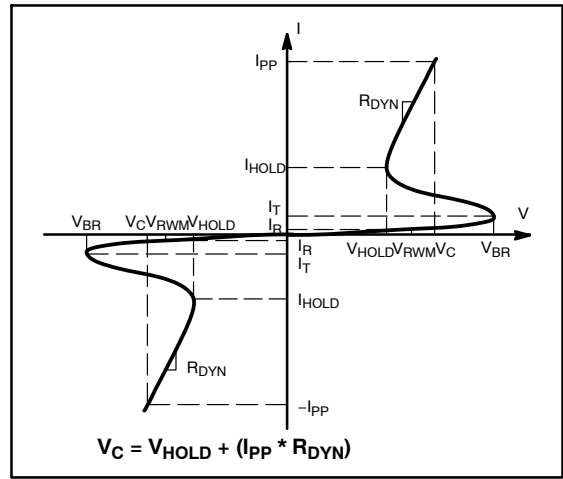

ELECTRICAL CHARACTERISTICS (T_A = 25°C unless otherwise specified)

Parameter	Symbol	Conditions	Min	Typ	Max	Unit
Reverse Working Voltage	V _{RWM}	I/O Pin to GND			3.3	V
Breakdown Voltage	V _{BR}	I _T = 1 mA, I/O Pin to GND	5.5		8.6	V
Reverse Leakage Current	I _R	V _{RWM} = 3.3 V, I/O Pin to GND			1.0	μA
Reverse Holding Voltage	V _{HOLD}	I/O Pin to GND		2.1		V
Holding Reverse Current	I _{HOLD}	I/O Pin to GND		17		mA
Clamping Voltage TLP (Note 1)	V _C	I _{PP} = 8 A } IEC 61000-4-2 Level 2 equivalent (±4 kV Contact, ±4 kV Air)		6.5		V
		I _{PP} = 16 A } IEC 61000-4-2 Level 2 equivalent (±8 kV Contact, ±15 kV Air)		10.2		
Reverse Peak Pulse Current	I _{PP}	IEC61000-4-5 (8/20 μs)	5.7	7.5		A
Clamping Voltage (8/20 μs)	V _C	I _{PP} = 5.7 A		5.6	6.5	V
Dynamic Resistance	R _{DYN}	I/O Pin to GND		0.46		Ω
Junction Capacitance	C _J	V _R = 0 V, f = 1 MHz		0.15	0.3	pF

Product parametric performance is indicated in the Electrical Characteristics for the listed test conditions, unless otherwise noted. Product performance may not be indicated by the Electrical Characteristics if operated under different conditions.

1. ANSI/ESD STM5.5.1 – Electrostatic Discharge Sensitivity Testing using Transmission Line Pulse (TLP) Model.

TLP conditions: Z₀ = 50 Ω, t_p = 100 ns, t_r = 1 ns, averaging window; t₁ = 70 ns to t₂ = 90 ns.

ESDL1531

TYPICAL CHARACTERISTICS

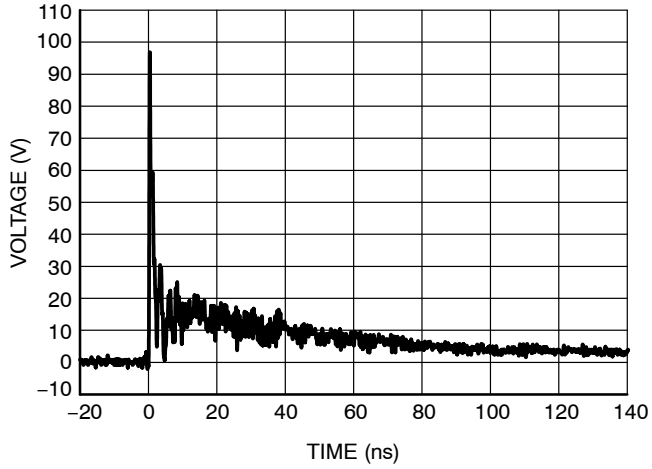

**Figure 1. ESD Clamping Voltage – Pin 1 to Pin 2
8 kV Contact per IEC61000-4-2**

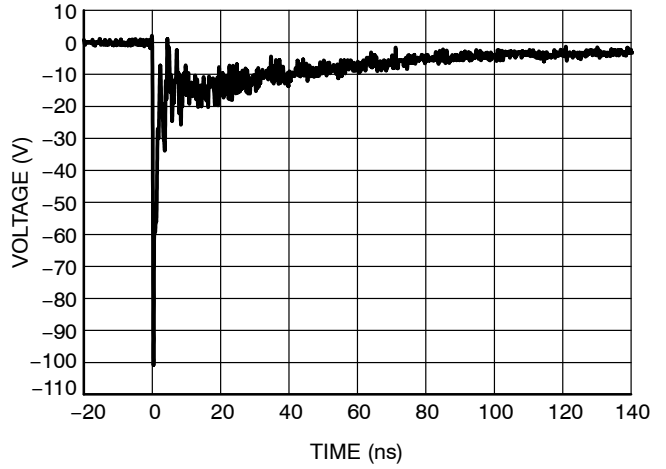

**Figure 2. ESD Clamping Voltage – Pin 2 to Pin 1
8 kV Contact per IEC61000-4-2**

TYPICAL CHARACTERISTICS

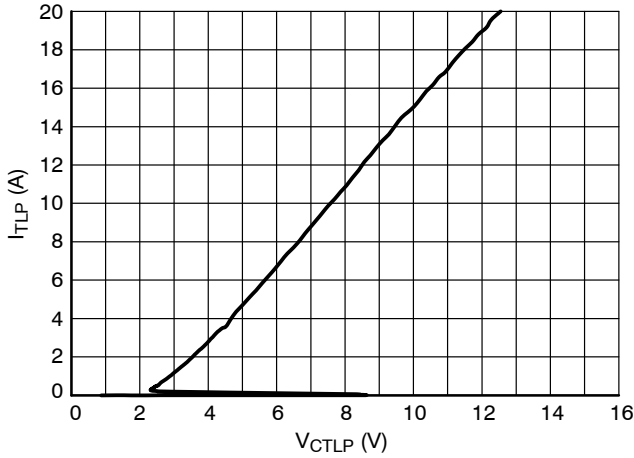

Figure 3. 100 ns TLP I-V Curve – Pin 1 to Pin 2

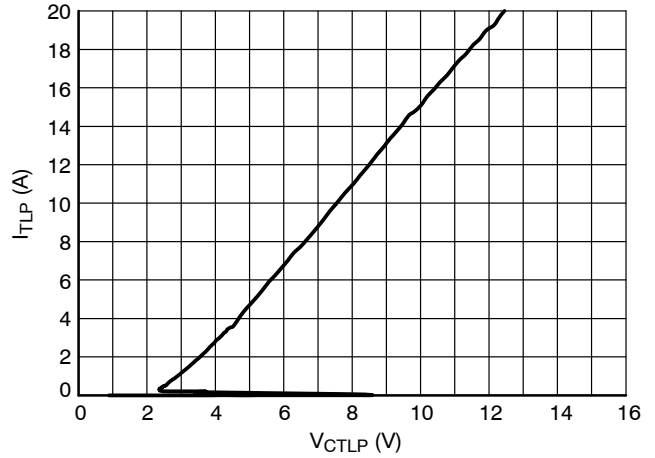

Figure 4. 100 ns TLP I-V Curve – Pin 2 to Pin 1

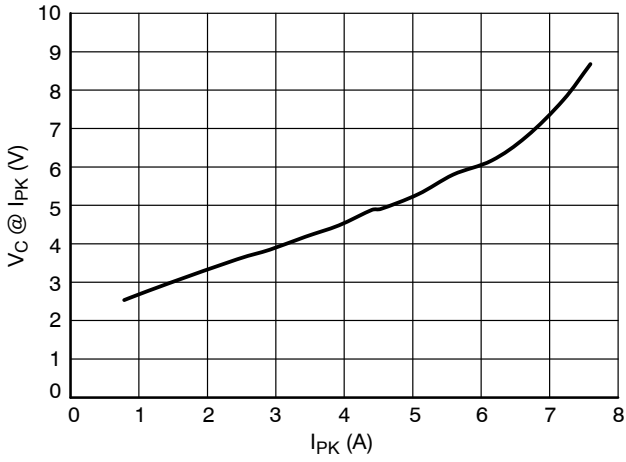

Figure 5. Clamping Voltage vs. Peak Pulse Current – Pin 1 to Pin 2 ($t_p = 8/20 \mu s$)

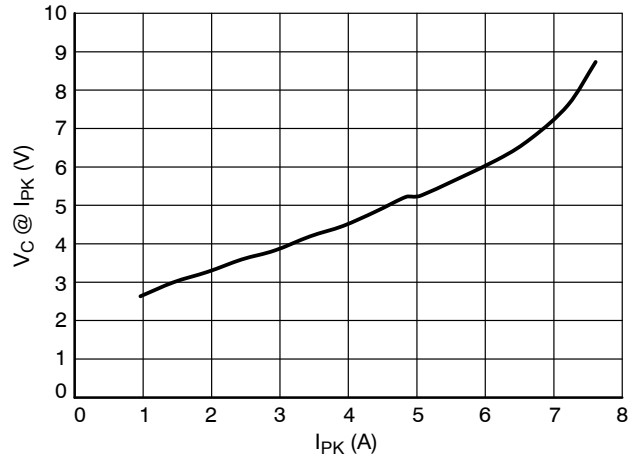

Figure 6. Clamping Voltage vs. Peak Pulse Current – Pin 2 to Pin 1 ($t_p = 8/20 \mu s$)

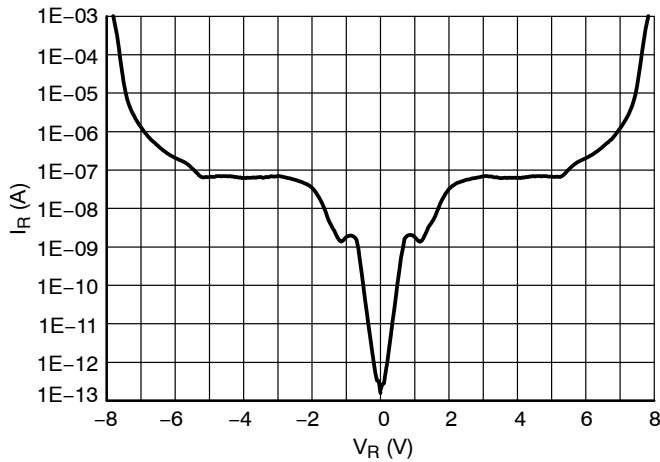

Figure 7. Reverse Leakage Current

ESDL1531

TYPICAL CHARACTERISTICS

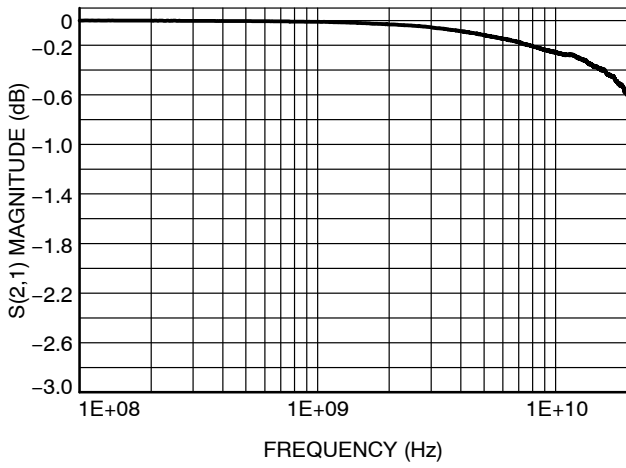

Figure 8. Insertion Loss

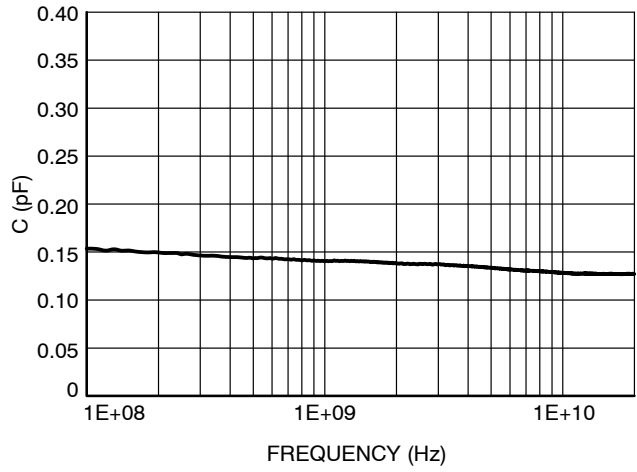

Figure 9. Capacitance Over Frequency

ORDERING INFORMATION

Device	Package	Shipping [†]
ESDL1531MX4T5G	X4DFN2 (Pb-Free)	10,000 / Tape & Reel

[†]For information on tape and reel specifications, including part orientation and tape sizes, please refer to our Tape and Reel Packaging Specifications Brochure, BRD8011/D.

IEC 61000-4-2 Spec.

Level	Test Voltage (kV)	First Peak Current (A)	Current at 30 ns (A)	Current at 60 ns (A)
1	2	7.5	4	2
2	4	15	8	4
3	6	22.5	12	6
4	8	30	16	8

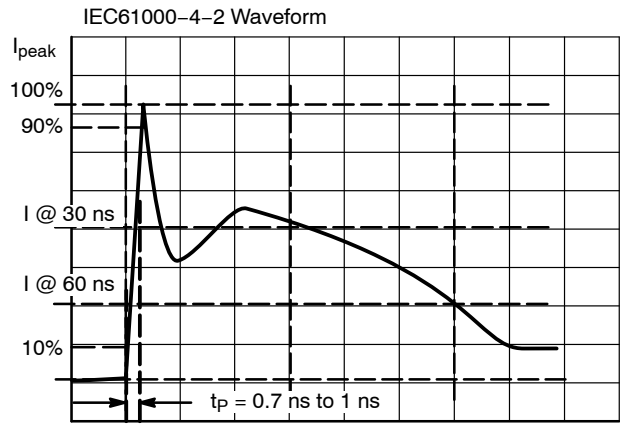

Figure 10. IEC61000-4-2 Spec

Transmission Line Pulse (TLP) Measurement

Transmission Line Pulse (TLP) provides current versus voltage (I-V) curves in which each data point is obtained from a 100 ns long rectangular pulse from a charged transmission line. A simplified schematic of a typical TLP system is shown in Figure 11. TLP I-V curves of ESD protection devices accurately demonstrate the product’s ESD capability because the 10s of amps current levels and under 100 ns time scale match those of an ESD event. This is illustrated in Figure 12 where an 8 kV IEC 61000-4-2 current waveform is compared with TLP current pulses at 8 A and 16 A. A TLP I-V curve shows the voltage at which the device turns on as well as how well the device clamps voltage over a range of current levels.

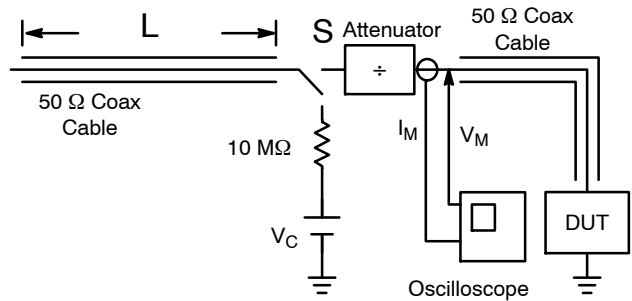

Figure 11. Simplified Schematic of a Typical TLP System

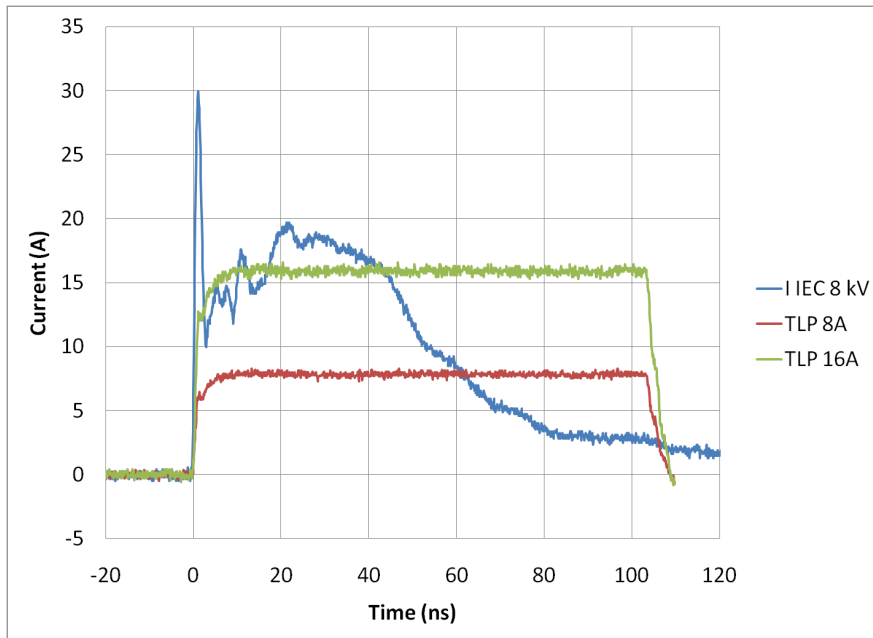

Figure 12. Comparison Between 8 kV IEC 61000-4-2 and 8 A and 16 A TLP Waveforms

MECHANICAL CASE OUTLINE

PACKAGE DIMENSIONS

ON Semiconductor®



SCALE 10:1

X4DFN2, 0.445x0.24, 0.27P
CASE 718AA
ISSUE A

DATE 21 MAR 2017

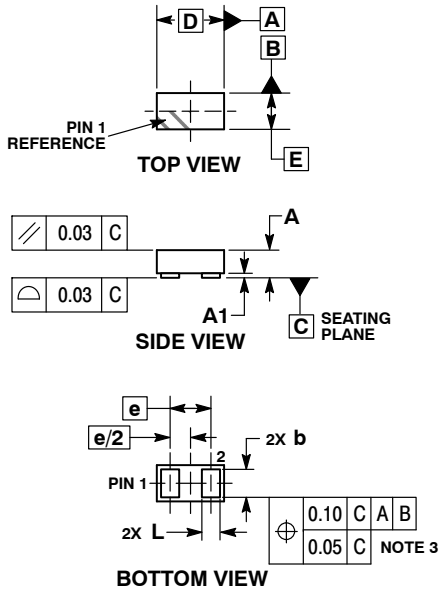

NOTES:

1. DIMENSIONING AND TOLERANCING PER ASME Y14.5M, 1994.
2. CONTROLLING DIMENSION: MILLIMETERS.
3. EXPOSED COPPER ALLOWED AS SHOWN.

DIM	MILLIMETERS		
	MIN	NOM	MAX
A	0.15	0.18	0.21
A1	---	---	0.03
b	0.170	0.185	0.200
D	0.415	0.445	0.475
E	0.210	0.240	0.270
e	0.270 BSC		
L	0.105	0.120	0.135

GENERIC MARKING DIAGRAMS*

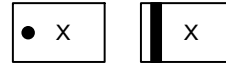

X = Specific Device Code

*This information is generic. Please refer to device data sheet for actual part marking. Some products may not follow the Generic Marking.

RECOMMENDED MOUNTING FOOTPRINT*

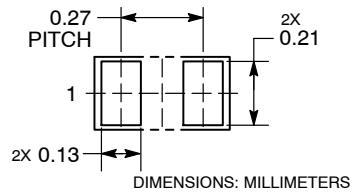

See Application Note AND8398/D for more mounting details
*For additional information on our Pb-Free strategy and soldering details, please download the ON Semiconductor Soldering and Mounting Techniques Reference Manual, SOLDERRM/D.

DOCUMENT NUMBER:	98AON29067G	Electronic versions are uncontrolled except when accessed directly from the Document Repository. Printed versions are uncontrolled except when stamped "CONTROLLED COPY" in red.
DESCRIPTION:	X4DFN2, 0.445X0.24, 0.27P	PAGE 1 OF 1

ON Semiconductor and are trademarks of Semiconductor Components Industries, LLC dba ON Semiconductor or its subsidiaries in the United States and/or other countries. ON Semiconductor reserves the right to make changes without further notice to any products herein. ON Semiconductor makes no warranty, representation or guarantee regarding the suitability of its products for any particular purpose, nor does ON Semiconductor assume any liability arising out of the application or use of any product or circuit, and specifically disclaims any and all liability, including without limitation special, consequential or incidental damages. ON Semiconductor does not convey any license under its patent rights nor the rights of others.

onsemi, **Onsemi**, and other names, marks, and brands are registered and/or common law trademarks of Semiconductor Components Industries, LLC dba "**onsemi**" or its affiliates and/or subsidiaries in the United States and/or other countries. **onsemi** owns the rights to a number of patents, trademarks, copyrights, trade secrets, and other intellectual property. A listing of **onsemi**'s product/patent coverage may be accessed at www.onsemi.com/site/pdf/Patent-Marking.pdf. **onsemi** reserves the right to make changes at any time to any products or information herein, without notice. The information herein is provided "as-is" and **onsemi** makes no warranty, representation or guarantee regarding the accuracy of the information, product features, availability, functionality, or suitability of its products for any particular purpose, nor does **onsemi** assume any liability arising out of the application or use of any product or circuit, and specifically disclaims any and all liability, including without limitation special, consequential or incidental damages. Buyer is responsible for its products and applications using **onsemi** products, including compliance with all laws, regulations and safety requirements or standards, regardless of any support or applications information provided by **onsemi**. "Typical" parameters which may be provided in **onsemi** data sheets and/or specifications can and do vary in different applications and actual performance may vary over time. All operating parameters, including "Typicals" must be validated for each customer application by customer's technical experts. **onsemi** does not convey any license under any of its intellectual property rights nor the rights of others. **onsemi** products are not designed, intended, or authorized for use as a critical component in life support systems or any FDA Class 3 medical devices or medical devices with a same or similar classification in a foreign jurisdiction or any devices intended for implantation in the human body. Should Buyer purchase or use **onsemi** products for any such unintended or unauthorized application, Buyer shall indemnify and hold **onsemi** and its officers, employees, subsidiaries, affiliates, and distributors harmless against all claims, costs, damages, and expenses, and reasonable attorney fees arising out of, directly or indirectly, any claim of personal injury or death associated with such unintended or unauthorized use, even if such claim alleges that **onsemi** was negligent regarding the design or manufacture of the part. **onsemi** is an Equal Opportunity/Affirmative Action Employer. This literature is subject to all applicable copyright laws and is not for resale in any manner.

ADDITIONAL INFORMATION

TECHNICAL PUBLICATIONS:

Technical Library: www.onsemi.com/design/resources/technical-documentation
onsemi Website: www.onsemi.com

ONLINE SUPPORT: www.onsemi.com/support

For additional information, please contact your local Sales Representative at www.onsemi.com/support/sales