

**Preliminary****ES/EMM5068VU****X-Band Power Amplifier MMIC****FEATURES**

- High Output Power: Pout=33.0dBm (typ.)
- High Linear Gain: GL=26.0dB (typ.)
- Broad Band: 9.5-13.3GHz
- Impedance Matched Zin/Zout=50Ω
- Small Hermetic Metal-Ceramic SMT Package(VU)

**DESCRIPTION**

The EMM5068VU is a MMIC amplifier that contains a three-stages amplifier, internally matched, for standard communications band in the 9.5 to 13.3GHz frequency range.

Eudyna Devices's stringent Quality Assurance Program assures the highest reliability and consistent performance.

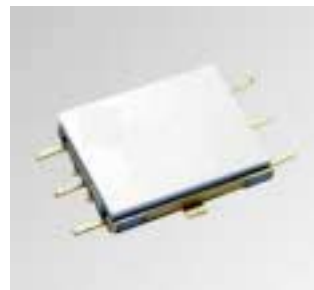
**ABSOLUTE MAXIMUM RATING**

Item	Symbol	Rating	Unit
Drain-Source Voltage	V <sub>DD</sub>	10	V
Gate-Source Voltage	V <sub>GG</sub>	-3	V
Input Power	P <sub>in</sub>	26	dBm
Channel Temperature	T <sub>ch</sub>	+175	°C
Storage Temperature	T <sub>stg</sub>	-55 to +125	°C

**RECOMMENDED OPERATING CONDITIONS**

Item	Symbol	Conditions	Unit
Drain-Source Voltage	V <sub>DD</sub>	6	V
Drain-Source Current	I <sub>DD</sub>	1300	mA
Input Power	P <sub>in</sub>	<=12	dBm
Operating Case Temperature	T <sub>op</sub>	-40 to +85	°C

**ELECTRICAL CHARACTERISTICS (Case Temperature Ta=25°C)**

Item	Symbol	Test Conditions	Limits			Unit
			Min.	Typ.	Max.	
Frequency Range	f	V <sub>DD</sub> =6V	9.5	-	13.3	GHz
Output Power at 1dB G.C.P.	P <sub>1dB</sub>	I <sub>DD</sub> =1300mA Z <sub>s</sub> =Z <sub>i</sub> =50ohm	31 <sup>*1</sup> 28 <sup>*2</sup>	33 <sup>*1</sup> 30 <sup>*2</sup>	-	dBm
Power Gain at 1dB G.C.P.	G <sub>1dB</sub>	*1:f=9.5~11.7GHz *2:f=11.7~13.3GHz	22 <sup>*1</sup> 20 <sup>*2</sup>	25 <sup>*1</sup> 23 <sup>*2</sup>	-	dB
Power-added Efficiency at 1dB G.C.P.	η <sub>add</sub>		-	21 <sup>*1</sup> 13 <sup>*2</sup>	-	%
Third Order Intermodulation*	IM <sub>3</sub>	*3:Δf=10MHz ,	-37 <sup>*3</sup>	-40 <sup>*3</sup>	-	dBc
Drain Current at 1dB G.C.P.	I <sub>DD</sub>	2-Tone Test, P <sub>out</sub> =20dBm S.C.L.	-	1700 <sup>*1</sup> 1500 <sup>*2</sup>	2400 <sup>*1</sup> 2400 <sup>*2</sup>	mA
Input Return Loss (at Pin=-20dBm)	RL <sub>in</sub>		-	-8	-	dB
Output Return Loss (at Pin=-20dBm)	RL <sub>out</sub>		-	-8	-	dB

G.C.P.:Gain Compression Point, S.C.L.:Single Carrier Level

ESD	Class 0	~ 199V
-----	---------	--------

Note : Based on EIAJ ED-4701 C-111A(C=100pF, R=1.5kΩ)

CASE STYLE	VU
------------	----

# ES/EMM5068VU

*Preliminary*

## X-Band Power Amplifier MMIC

OUTPUT POWER vs. FREQUENCY

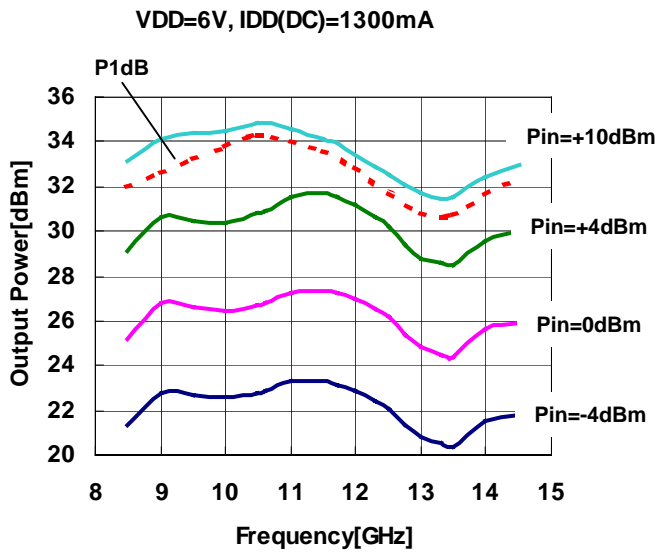

OUTPUT POWER , DRAIN CURRENT vs. INPUT POWER

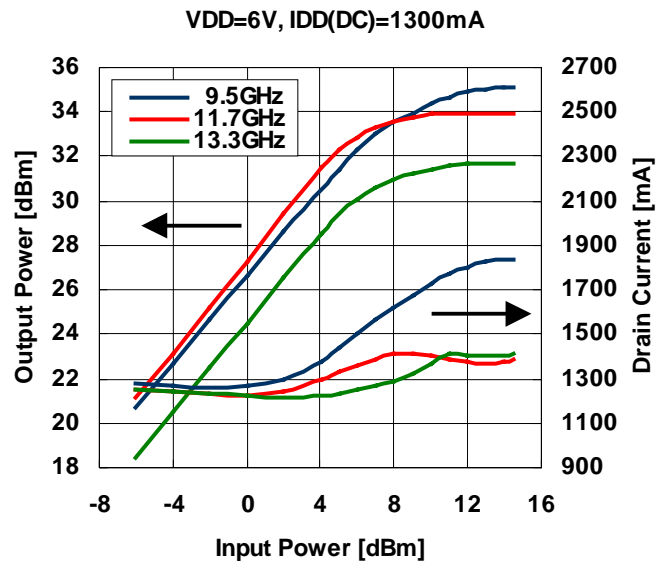

POWER ADDED EFFICIENCY vs FREQUENCY

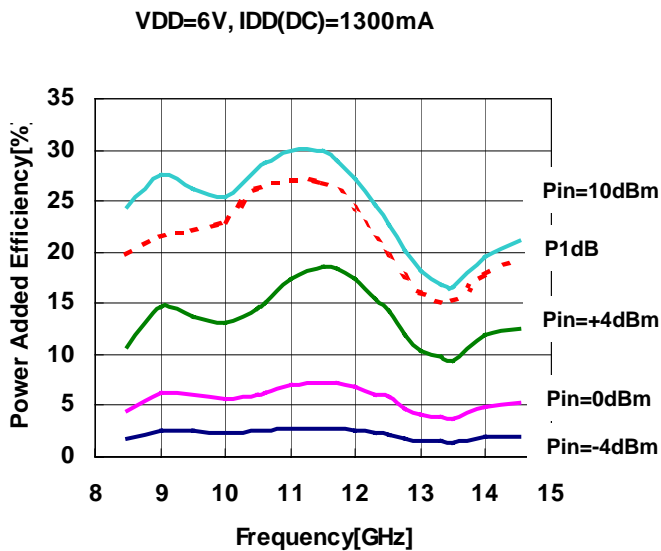

**Eudyna**

**Preliminary**

# ES/EMM5068VU

## X-Band Power Amplifier MMIC

**IMD vs. FREQUENCY**

VDD=6V, IDD(DC)=1300mA, Pout=20dBm S.C.L.

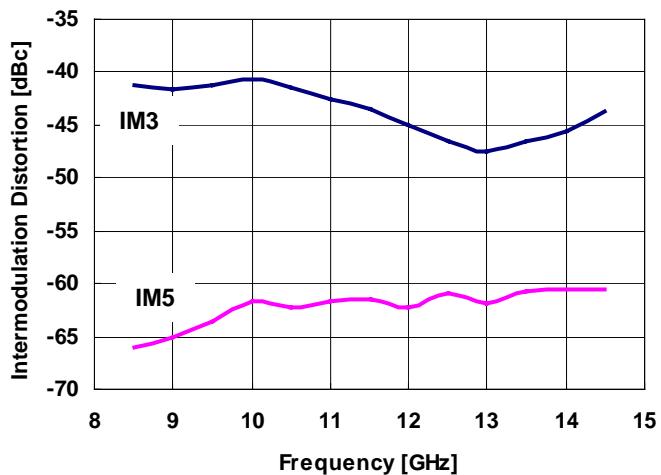

**IMD vs OUTPUT POWER**

VDD=6V, IDD(DC)=1300mA

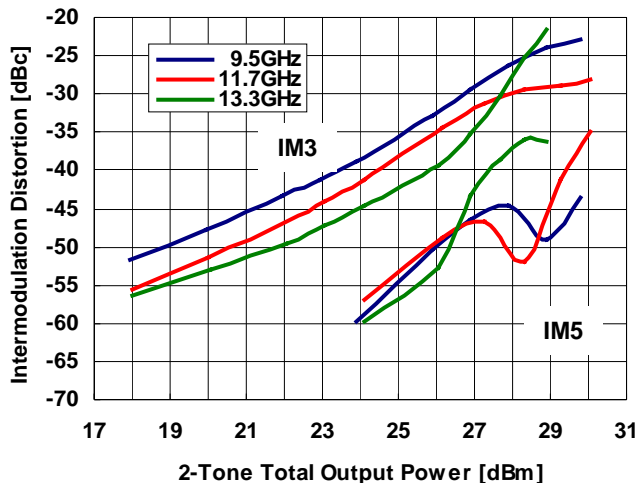

**Eudyna**

# ES/EMM5068VU

## X-Band Power Amplifier MMIC

Preliminary

OUTPUT POWER, DRAIN CURRENT vs. INPUT POWER by Drain Voltage

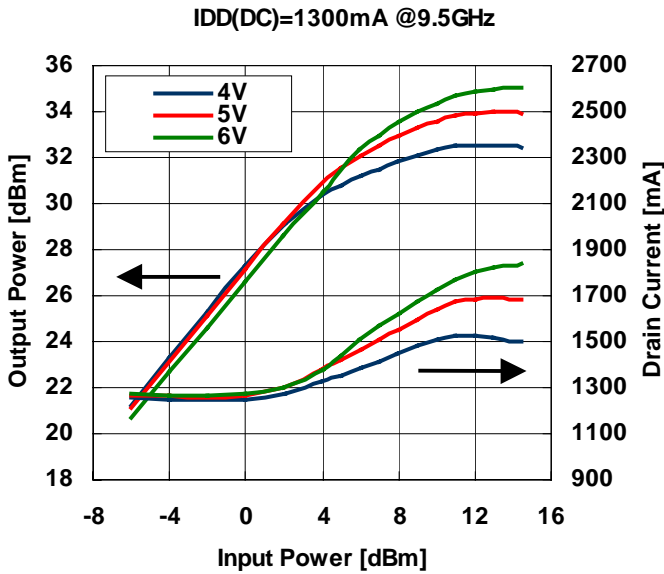

OUTPUT POWER, DRAIN CURRENT vs. INPUT POWER by Drain Voltage

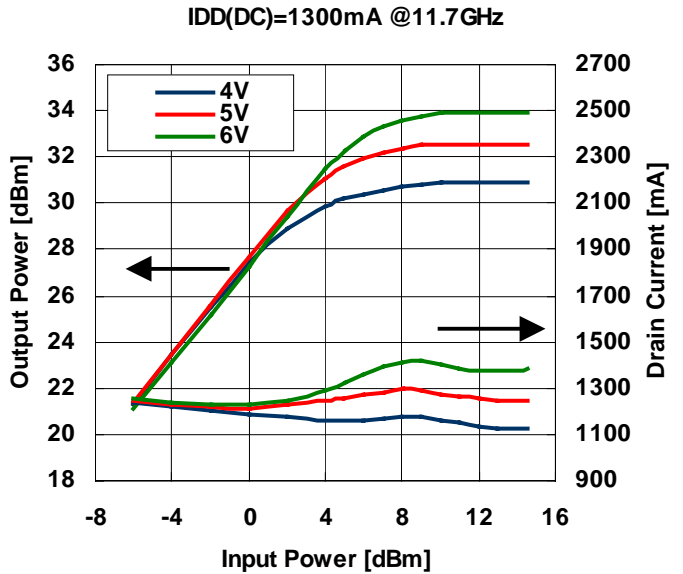

OUTPUT POWER, DRAIN CURRENT vs. INPUT POWER by Drain Voltage

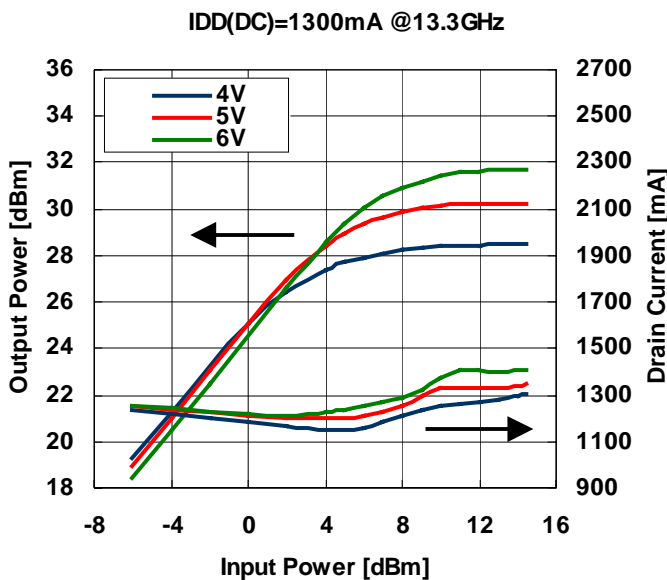

OUTPUT POWER, GAIN vs. DRAIN VOLTAGE

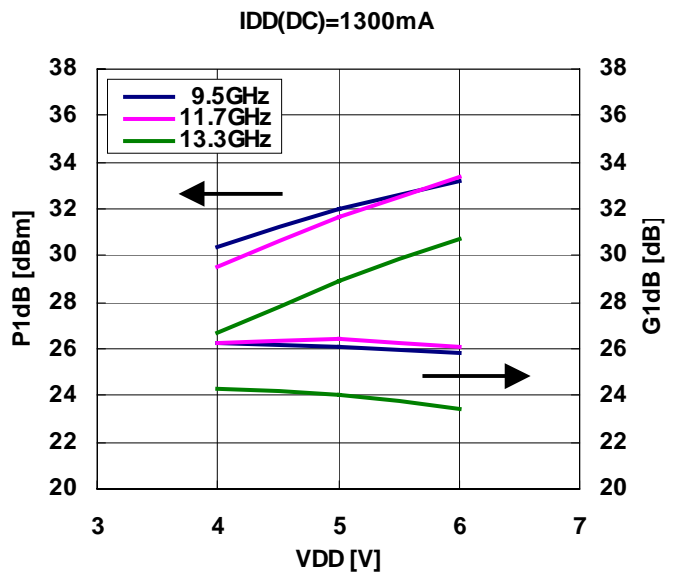

**Preliminary**

# ES/EMM5068VU

## X-Band Power Amplifier MMIC

**OUTPUT POWER, DRAIN CURRENT vs. INPUT POWER by Drain Current**

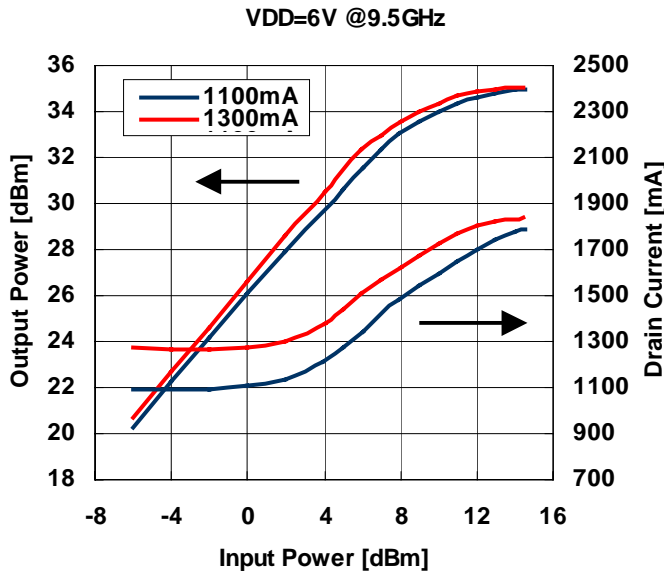

**OUTPUT POWER, DRAIN CURRENT vs. INPUT POWER by Drain Current**

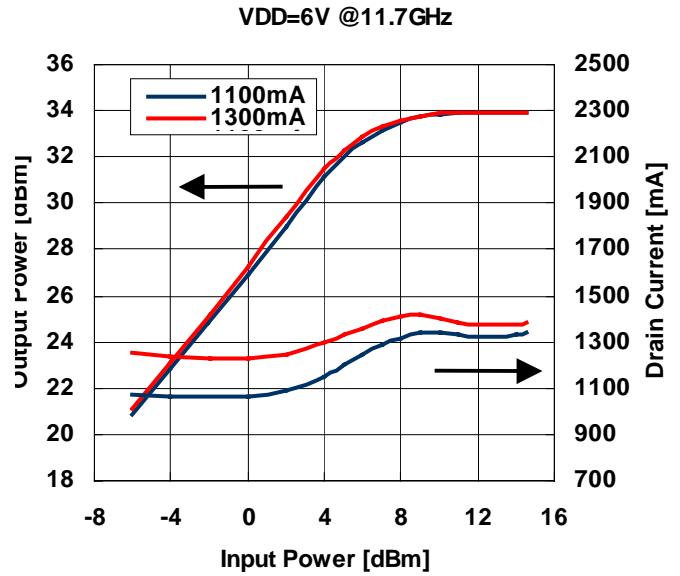

**OUTPUT POWER, DRAIN CURRENT vs. INPUT POWER by Drain Current**

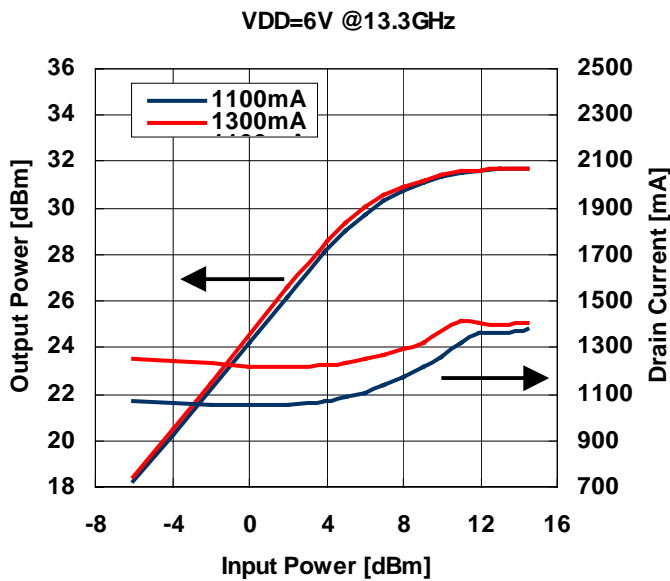

**OUTPUT POWER, GAIN vs. Drain Current**

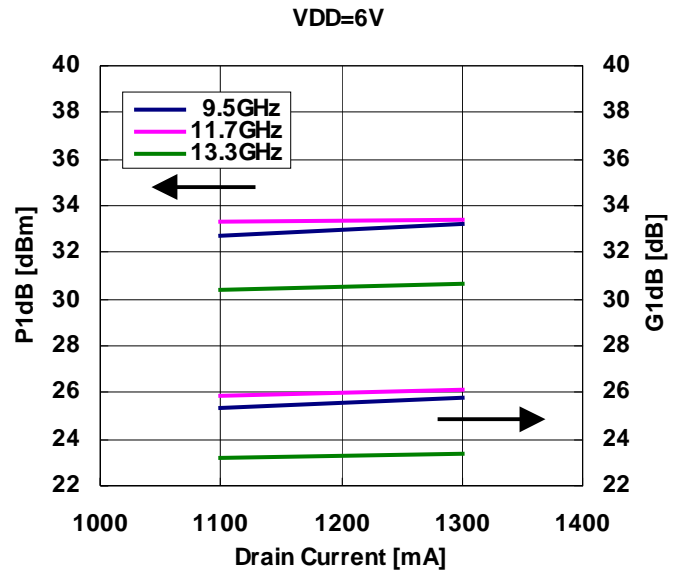

**Eudyna**

# ES/EMM5068VU

## X-Band Power Amplifier MMIC

*Preliminary*

IMD PERFORMANCE vs OUTPUT POWER  
by Drain Voltage

IDD(DC)=1300mA @9.5GHz

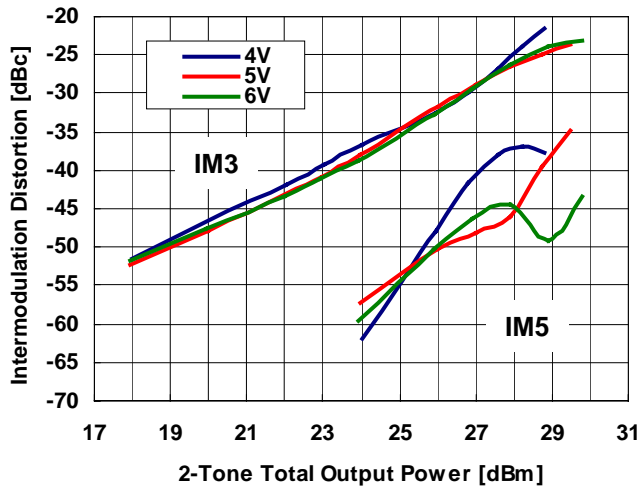

IMD PERFORMANCE vs OUTPUT POWER  
by Drain Voltage

IDD(DC)=1300mA @11.7GHz

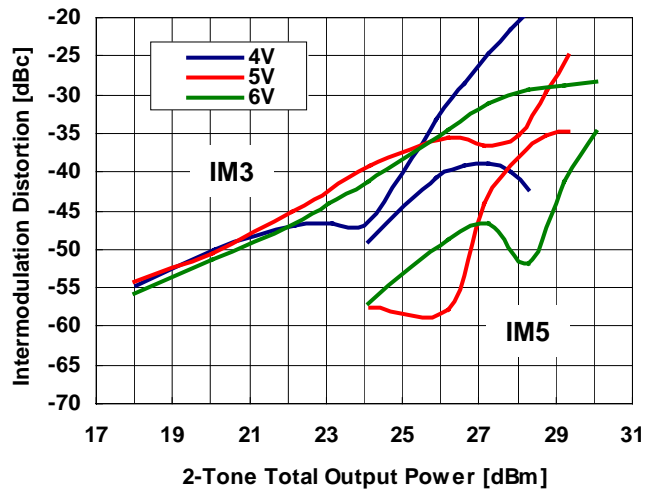

IMD PERFORMANCE vs OUTPUT POWER  
by Drain Voltage

IDD(DC)=1300mA @13.3GHz

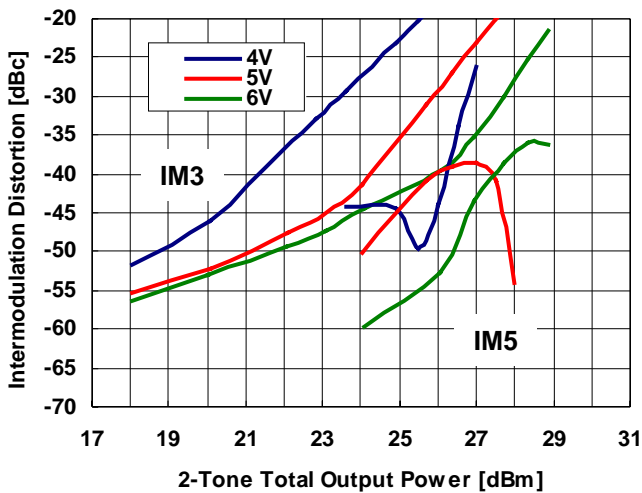

**Eudyna**

**Preliminary**

# ES/EMM5068VU

## X-Band Power Amplifier MMIC

**IMD PERFORMANCE vs OUTPUT POWER  
by Drain Current**

VDD=6V @9.5GHz

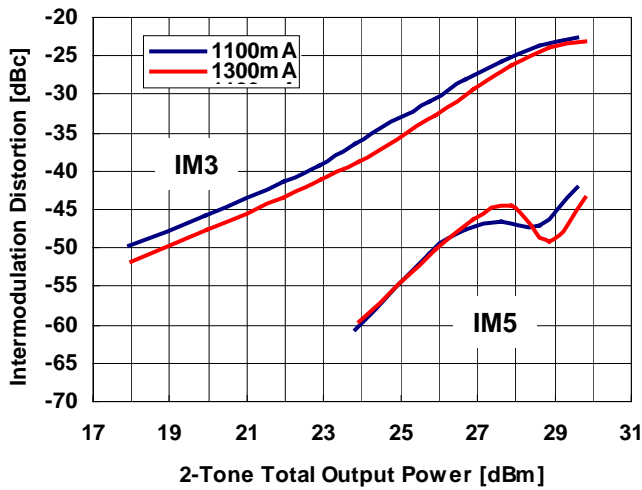

**IMD PERFORMANCE vs OUTPUT POWER  
by Drain Current**

VDD=6V @11.7GHz

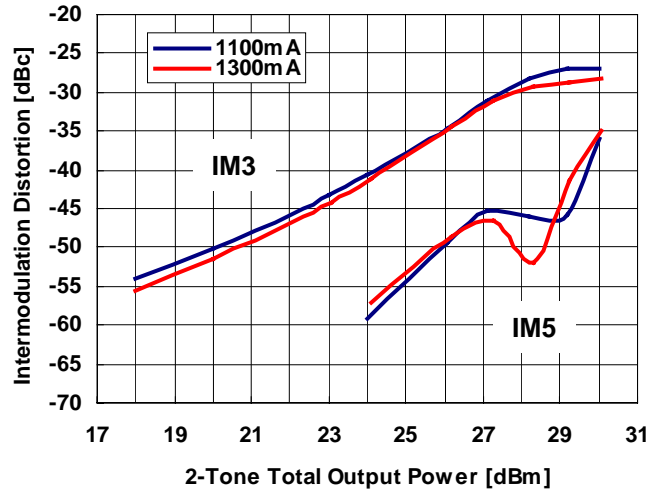

**IMD PERFORMANCE vs OUTPUT POWER  
by Drain Current**

VDD=6V @13.3GHz

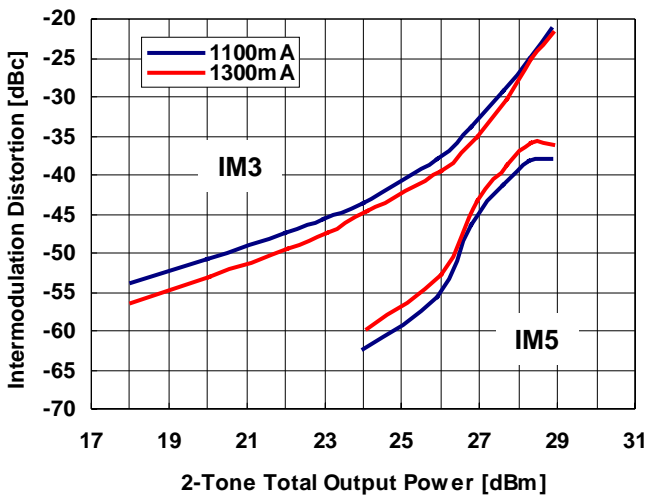

**Eudyna**

# ES/EMM5068VU

Preliminary

X-Band Power Amplifier MMIC

OUTPUT POWER, GAIN vs. TEMPERATURE

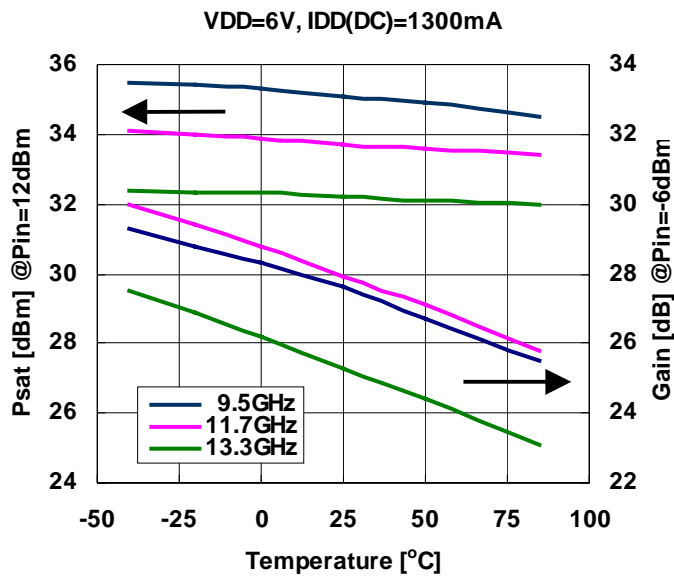



**Preliminary**

# ES/EMM5068VU

X-Band Power Amplifier MMIC

■ S-PARAMETER

VDD=6V, IDD(DC)=1300mA

Input/Output Return Loss vs. Frequency  
VDD=6V, IDD=1300mA

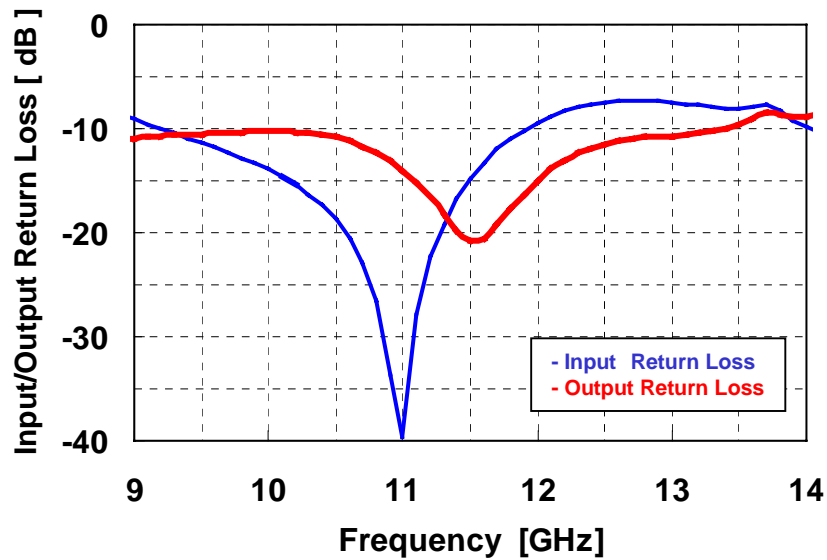

Small Signal Gain vs. Frequency  
VDD=6V, IDD=1300mA

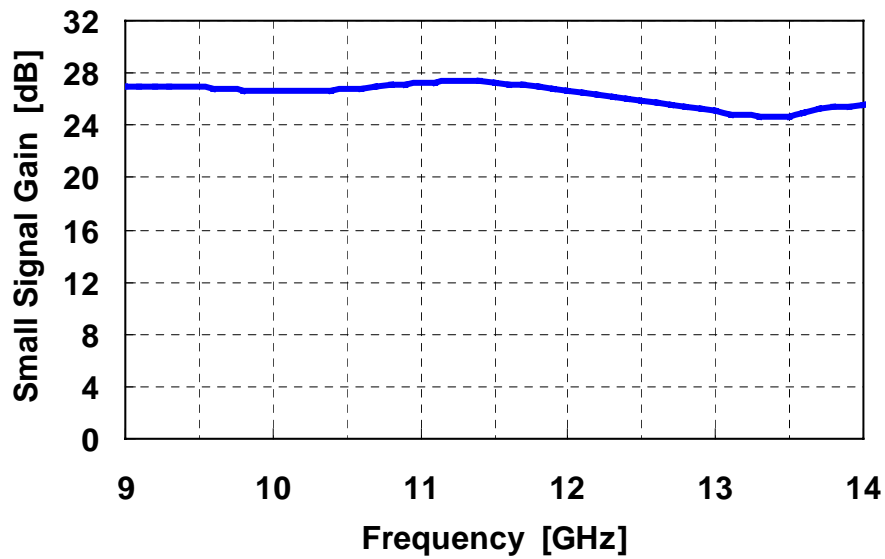

**Eudyna**

**ES/EMM5068VU****Preliminary****X-Band Power Amplifier MMIC****■ S-PARAMETER**

VDD=6V, IDD(DC)=1300mA

Frequency [GHz]	S11		S21		S12		S22	
	MAG	ANG	MAG	ANG	MAG	ANG	MAG	ANG
9.3	0.299	-75.9	22.375	-37.1	0.001	-159.0	0.293	-24.1
9.4	0.286	-79.8	22.230	-51.7	0.001	-171.2	0.296	-29.0
9.5	0.272	-83.1	22.101	-66.1	0.001	-166.0	0.297	-33.3
9.6	0.258	-86.8	21.906	-80.0	0.001	-174.2	0.300	-37.5
9.7	0.243	-90.2	21.784	-93.7	0.000	-174.7	0.304	-40.9
9.8	0.229	-93.7	21.610	-107.1	0.001	-162.9	0.305	-44.2
9.9	0.217	-97.2	21.473	-120.1	0.001	-166.4	0.307	-47.4
10.0	0.203	-99.4	21.385	-133.1	0.001	-170.5	0.308	-50.2
10.1	0.186	-102.3	21.328	-145.8	0.000	179.6	0.307	-52.9
10.2	0.171	-105.8	21.373	-158.5	0.000	-177.1	0.305	-55.8
10.3	0.153	-108.6	21.461	-171.0	0.001	-154.3	0.301	-58.2
10.4	0.136	-111.9	21.575	176.5	0.001	-145.5	0.294	-61.0
10.5	0.117	-113.8	21.702	163.9	0.001	-153.6	0.287	-63.4
10.6	0.094	-115.0	21.904	151.3	0.001	-152.2	0.276	-65.7
10.7	0.071	-118.0	22.113	138.4	0.001	-143.1	0.261	-67.9
10.8	0.047	-119.8	22.540	125.6	0.001	-144.8	0.243	-70.1
10.9	0.021	-112.0	22.708	112.4	0.001	-139.4	0.224	-71.4
11.0	0.010	6.6	22.883	99.4	0.001	-142.2	0.200	-72.3
11.1	0.040	30.3	23.161	85.7	0.001	-143.1	0.174	-72.2
11.2	0.076	31.8	23.333	72.0	0.001	-131.6	0.148	-69.8
11.3	0.110	30.0	23.299	58.4	0.001	-134.6	0.123	-63.9
11.4	0.146	26.0	23.283	44.8	0.001	-136.1	0.102	-53.2
11.5	0.181	21.2	23.129	30.9	0.001	-143.5	0.092	-36.7
11.6	0.216	16.4	22.757	17.3	0.001	-147.5	0.093	-18.2
11.7	0.251	12.0	22.587	3.7	0.001	-143.9	0.109	-4.8
11.8	0.282	8.4	22.307	-9.8	0.001	-136.8	0.131	4.1
11.9	0.307	4.0	21.801	-23.0	0.001	-144.0	0.154	8.5
12.0	0.337	-0.2	21.387	-36.2	0.001	-130.5	0.179	10.1
12.1	0.359	-4.4	21.113	-49.4	0.001	-141.1	0.202	10.5
12.2	0.385	-8.6	20.670	-62.4	0.001	-131.9	0.223	9.5
12.3	0.403	-12.0	20.338	-75.0	0.001	-133.6	0.240	8.5
12.4	0.414	-16.4	20.065	-88.1	0.001	-120.0	0.255	6.8
12.5	0.426	-20.5	19.624	-101.1	0.001	-121.0	0.267	4.9
12.6	0.433	-24.3	19.288	-114.4	0.001	-117.6	0.276	3.2
12.7	0.436	-28.3	19.027	-127.2	0.001	-119.3	0.282	1.4
12.8	0.436	-31.4	18.654	-140.1	0.002	-111.7	0.287	0.1
12.9	0.429	-34.4	18.195	-152.8	0.002	-112.5	0.290	-1.2
13.0	0.421	-37.5	17.858	-165.5	0.002	-113.4	0.292	-2.3
13.1	0.415	-39.8	17.512	-178.2	0.002	-117.5	0.297	-2.8
13.2	0.408	-41.9	17.274	169.3	0.002	-123.3	0.300	-3.6
13.3	0.402	-43.8	17.111	157.4	0.003	-126.9	0.309	-4.3
13.4	0.398	-45.3	17.108	144.9	0.003	-131.6	0.319	-5.4
13.5	0.394	-47.3	17.181	132.6	0.004	-132.3	0.334	-6.8

**Eudyna**

**Preliminary**

**ES/EMM5068VU**

**X-Band Power Amplifier MMIC**

**ΔTch vs. DRAIN VOLTAGE**  
 (Reference Data)  
 IDD(DC)=1300mA

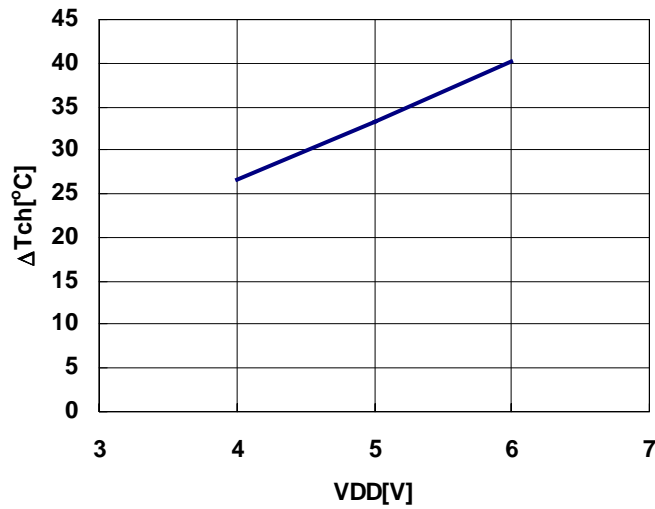

Note : ΔTch : Channel Temperature Rise from PCB surface

**MTTF vs. Tch**

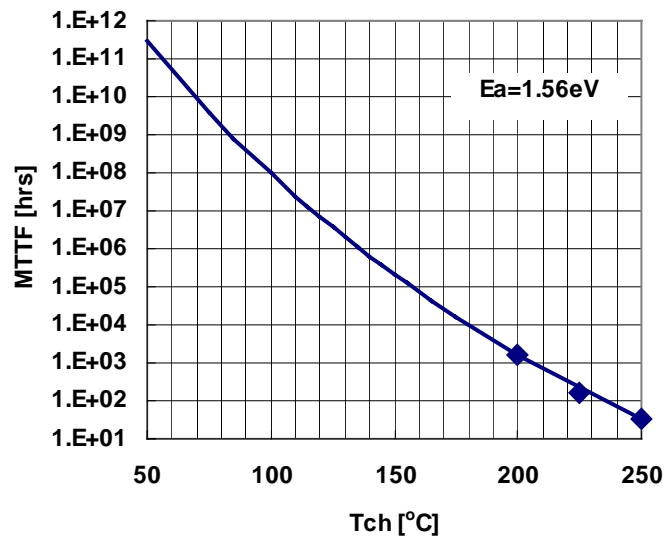

**Eudyna**

# ES/EMM5068VU

**Preliminary**

## X-Band Power Amplifier MMIC

### ■ Block diagram

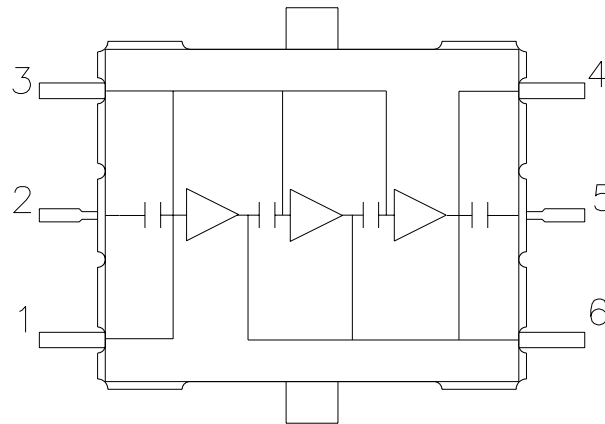

#### PIN ASSIGNMENT

- 1 : VGG
- 2 : RF in
- 3 : VGG
- 4 : VDD
- 5 : RF out
- 6 : VDD

### ■ Recommended Bias Circuit

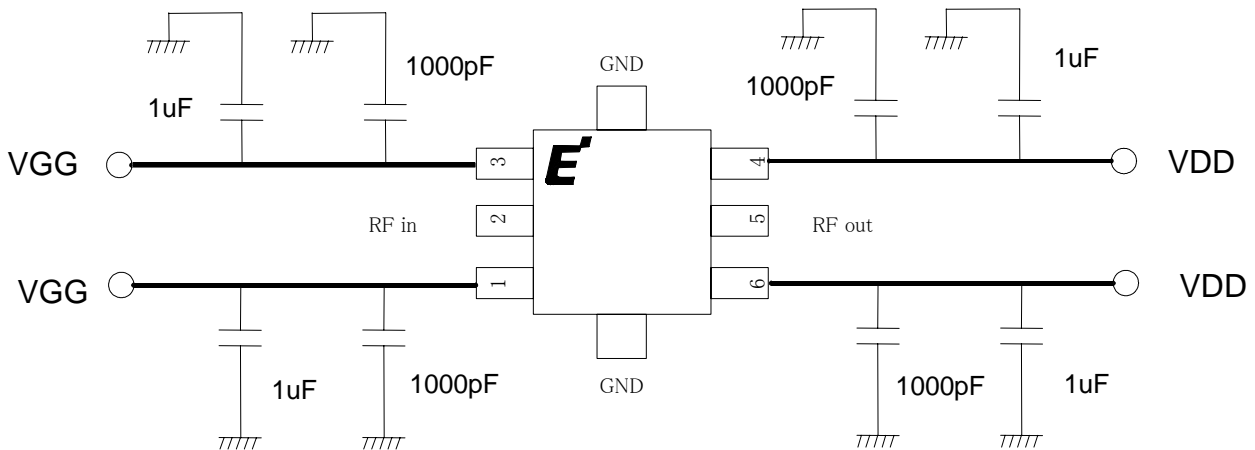

Note 1: The capacitors are recommended on the bias supply line, close to the package, in order to prevent video oscillations which could damage the module.

Note 2: Two pins named VGG are internally connected.

Note 3: Two pins named VDD are internally connected.

**Preliminary**

**ES/EMM5068VU**

**X-Band Power Amplifier MMIC**

■ Package Outline

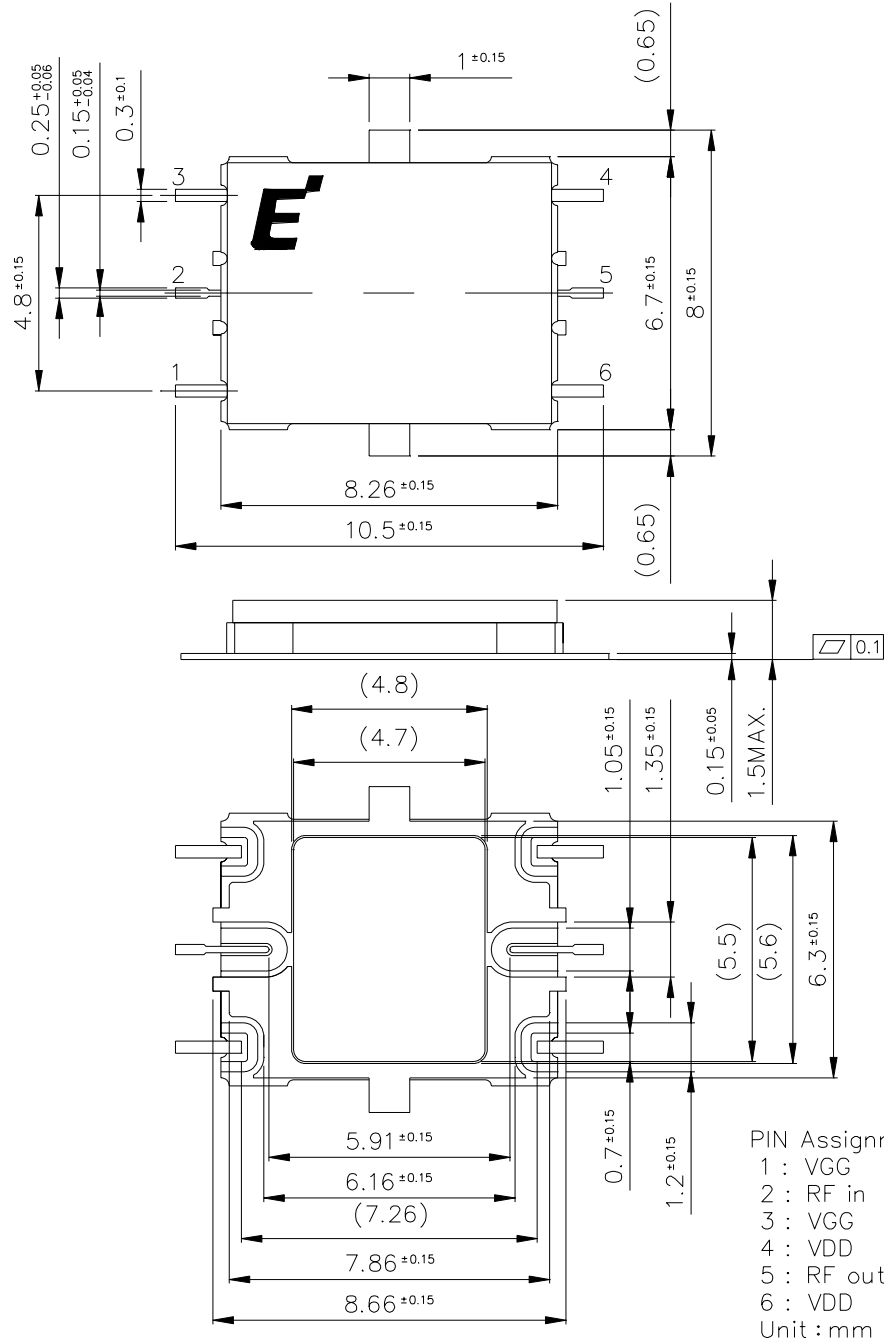

# ES/EMM5068VU

**Preliminary**

## X-Band Power Amplifier MMIC

### ■ PCB Pads and Solder-resist Pattern

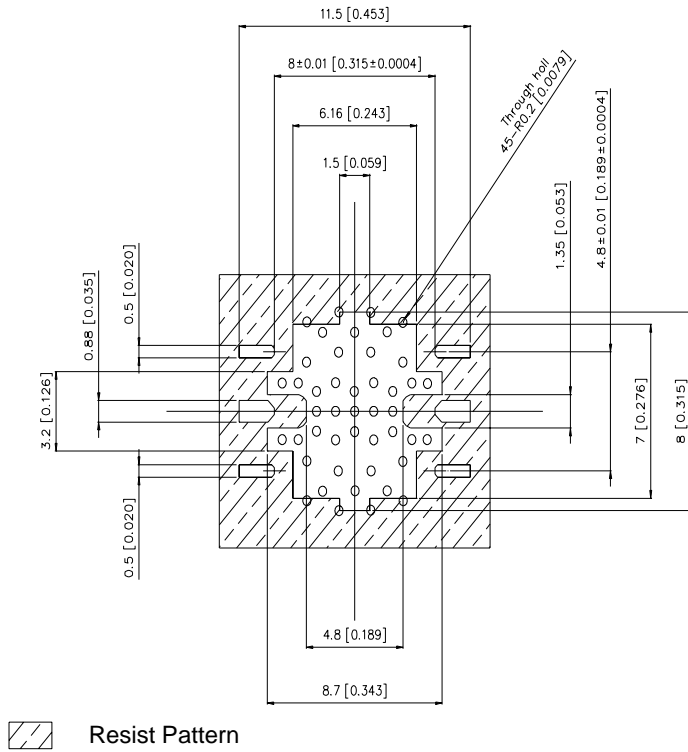

Unit: mm [inches]  
 PCB: Diclad-522  
 Under plating: Cu  
                   : Nickel (Ni) 1 ~ 4 μm  
 Top plating: Gold (Au)  
 (Flash plating 0.1 μm or less)

**Preliminary**

# ES/EMM5068VU

## X-Band Power Amplifier MMIC

### ■ TUNING PERFORMANCE

Device performance at higher band (11.7 to 13.3GHz) can be improved by changing PCB line pattern.

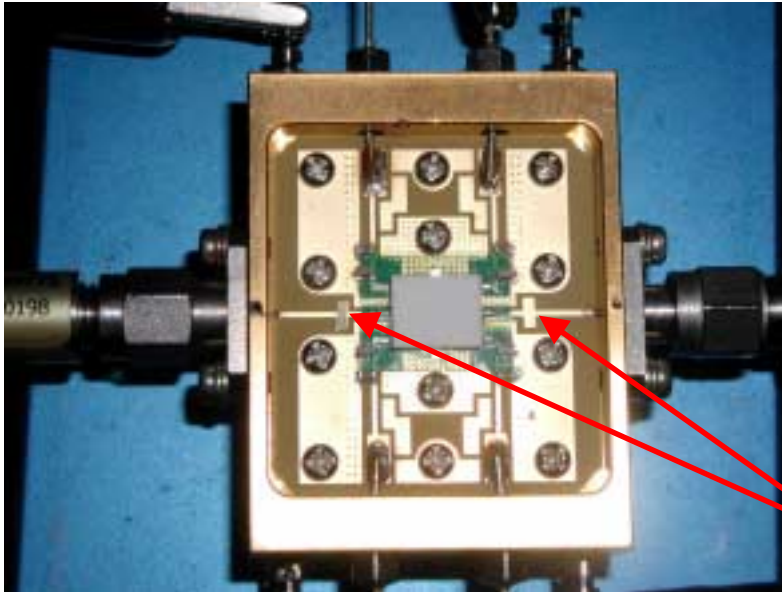

PCB: RO4003  
Er : 3.38  
Thickness : 0.2mm

Tuning Stub

Output Power vs. Frequency

IMD vs. Output Power

VDD=6V, IDD(DC)=1300mA, with-Tuning

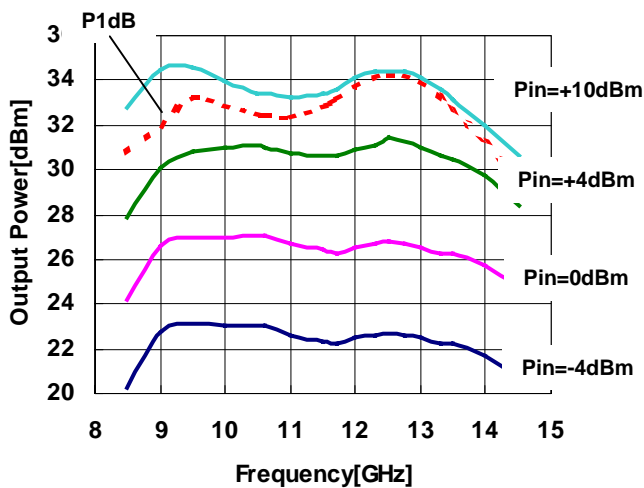

VDD=6V, IDD(DC)=1300mA, with-Tuning

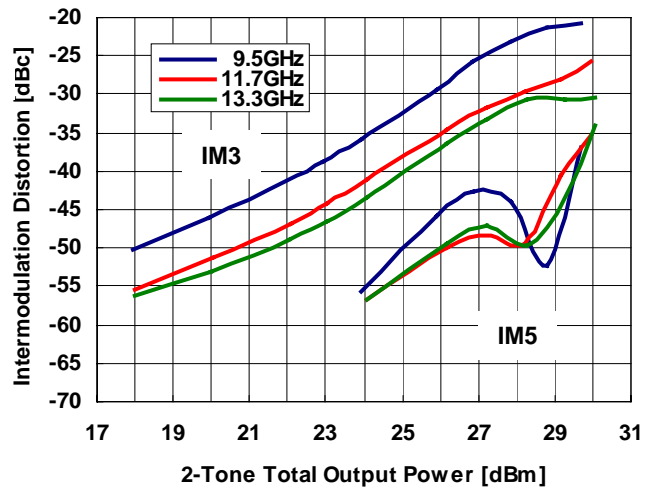

**Eudyna**

# ES/EMM5068VU

**Preliminary**

## X-Band Power Amplifier MMIC

For further information please contact :

**Eudyna Devices USA Inc.**  
2355 Zanker Rd.  
San Jose, CA 95131-1138, U.S.A.  
TEL: (408) 232-9500  
FAX: (408) 428-9111  
www.us.eudyna.com

**Eudyna Devices Europe Ltd.**  
Network House  
Norreys Drive  
Maidenhead, Berkshire SL6 4FJ  
United Kingdom  
TEL: +44 (0) 1628 504800  
FAX: +44 (0) 1628 504888

**Eudyna Devices Asia Pte. Ltd.**  
Hong Kong Branch  
Rm.1101,Ocean Centre, 5 Canton Road  
Tsim Sha Tsui, Kowloon, Hong Kong  
TEL: +852-2377-0227  
FAX: +852-2377-3921

**Eudyna Devices Inc.**  
Sales Division  
1, Kanai-cho, Sakae-ku  
Yokohama, 244-0845, Japan  
TEL +81-45-853-8156  
FAX +81-45-853-8170

### CAUTION

Eudyna Devices Inc. products contain **gallium arsenide (GaAs)** which can be hazardous to the human body and the environment. For safety, observe the following procedures:

- Do not put these products into the mouth.
- Do not alter the form of this product into a gas, powder, or liquid through burning, crushing, or chemical processing as these by-products are dangerous to the human body if inhaled, ingested, or swallowed.
- Observe government laws and company regulations when discarding this product. This product must be discarded in accordance with methods specified by applicable hazardous waste procedures.

Eudyna Devices Inc. reserves the right to change products and specifications without notice. The information does not convey any license under rights of Eudyna Devices Inc. or others.

© 2005 Eudyna Devices USA Inc.  
Printed in U.S.A.

**Eudyna**