

Preliminary

ES/EMM5832VU

K-Band Power Amplifier MMIC

FEATURES

- High Output Power: Pout=31.0dBm (typ.)
- High Linear Gain: GL=23.0dB (typ.)
- Broad Band: 21.2~26.5GHz
- Impedance Matched Zin/Zout=50Ω
- Small Hermetic Metal-Ceramic SMT Package(VU)

DESCRIPTION

The EMM5832VU is a MMIC amplifier that contains a four-stage amplifier, internally matched, for standard communications band in the 21.2 to 26.5GHz frequency range.

Eudyna Devices's stringent Quality Assurance Program assures the highest reliability and consistent performance.

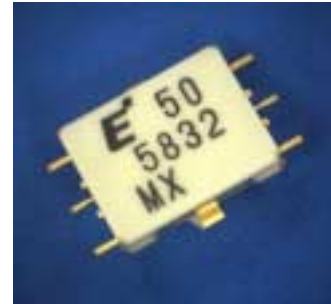

ABSOLUTE MAXIMUM RATING

Item	Symbol	Rating	Unit
Drain-Source Voltage	V _{DD}	10	V
Gate-Source Voltage	V _{GG}	-3	V
Input Power	P _{in}	22	dBm
Storage Temperature	T _{stg}	-55 to +125	°C

RECOMMENDED OPERATING CONDITIONS

Item	Symbol	Condition	Unit
Drain-Source Voltage	V _{DD}	≤7	V
Input Power	P _{in}	≤12	dBm
Operating Case Temperature	T _C	-40 to +85	°C

ELECTRICAL CHARACTERISTICS (Case Temperature Ta=25°C)

Item	Symbol	Test Conditions	Limits			Unit
			Min.	Typ.	Max.	
RF Frequency Range	f	V _{DD} =+6V	21.2	-	26.5	GHz
Output Power at 1dB G.C.P.	P _{1dB}	I _{DD(DC)} =800mA typ.	TBD	31	-	dBm
Power Gain at 1dB G.C.P.	G _{1dB}	Z _S =Z _L =50ohm	TBD	21	TBD	dB
Power-added Efficiency at 1dB G.C.P.	η _{add}		-	20	-	%
Drain Current at 1dB G.C.P.	I _{DDRF}		-	1000	TBD	mA
3rd. Order Intermodulation Distortion *	IM ₃	* df=+10MHz	TBD	33	-	dBc
Input Return Loss (at Pin=-20dBm)	RL _{IN}	Po=20dBm S.C.L	-	-8	-	dB
Output Return Loss (at Pin=-20dBm)	RL _{OUT}		-	-8	-	dB

G.C.P. : Gain Compression Point
S.C.L. : Single Carrier Level

ESD	Class 0	~199V
-----	---------	-------

Note : Based on EIAJ ED4701 C-111A(C=100pF, R=1.5kohm)

CASE STYLE	VU
------------	----

ES/EMM5832VU

K-Band Power Amplifier MMIC

Preliminary

OUTPUT POWER vs. FREQUENCY

VDD=6V, IDD(DC)=800mA

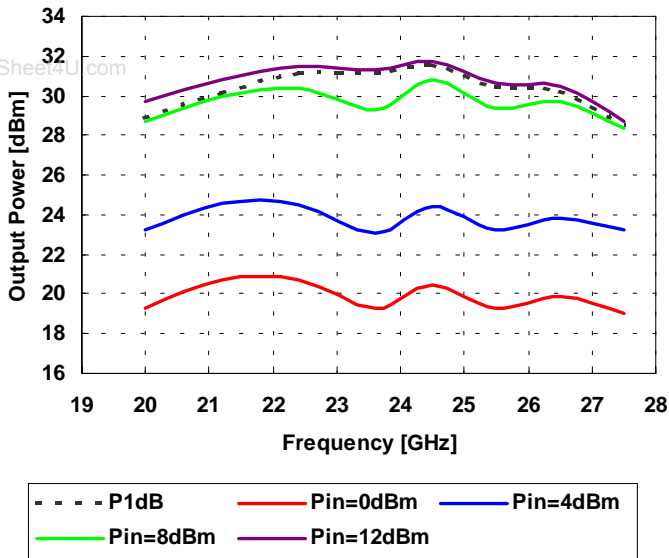

OUTPUT POWER, DRAIN CURRENT vs. INPUT POWER

VDD=6V, IDD(DC)=800mA

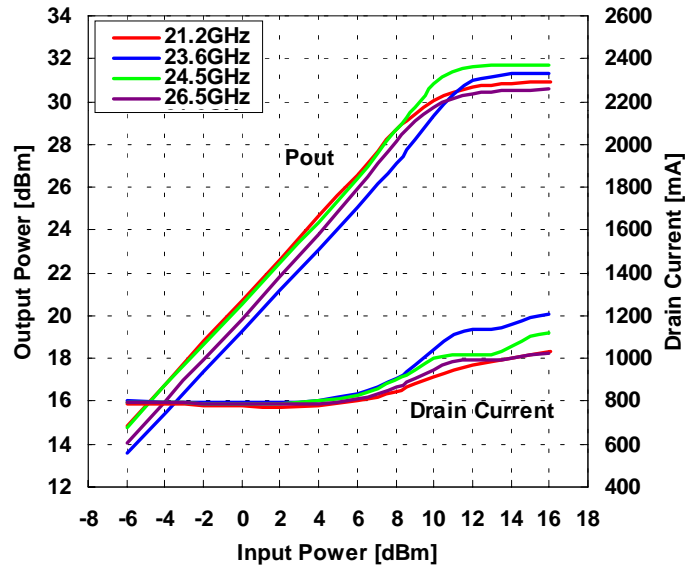

POWER-ADDED EFFICIENCY vs FREQUENCY

VDD=6V, IDD(DC)=800mA

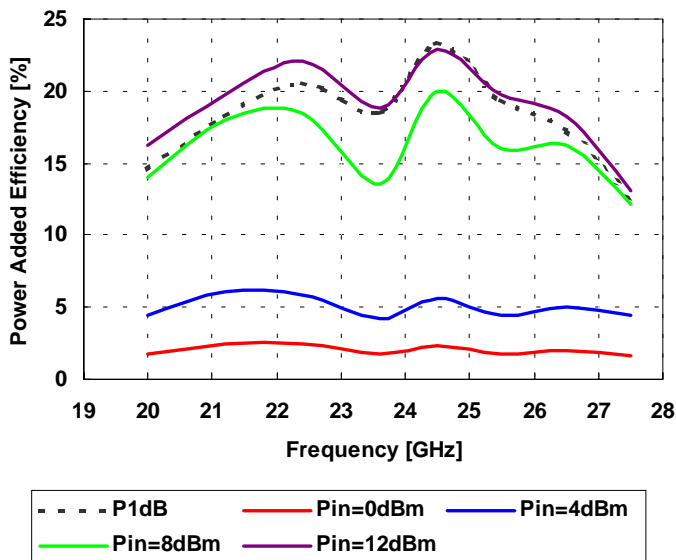

Eudyna

Preliminary

ES/EMM5832VU

K-Band Power Amplifier MMIC

IMD vs. FREQUENCY

VDD=6V, IDD(DC)=800mA, Pout=20dBm S.C.L

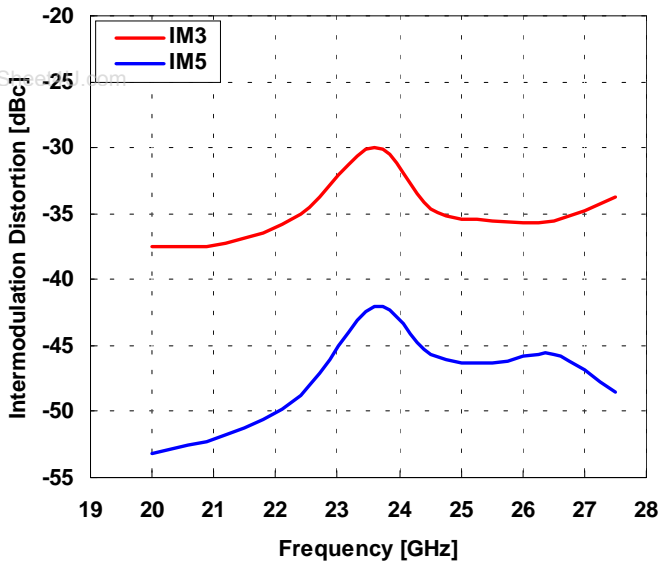

IMD vs OUTPUT POWER

VDD=6V, IDD(DC)=800mA

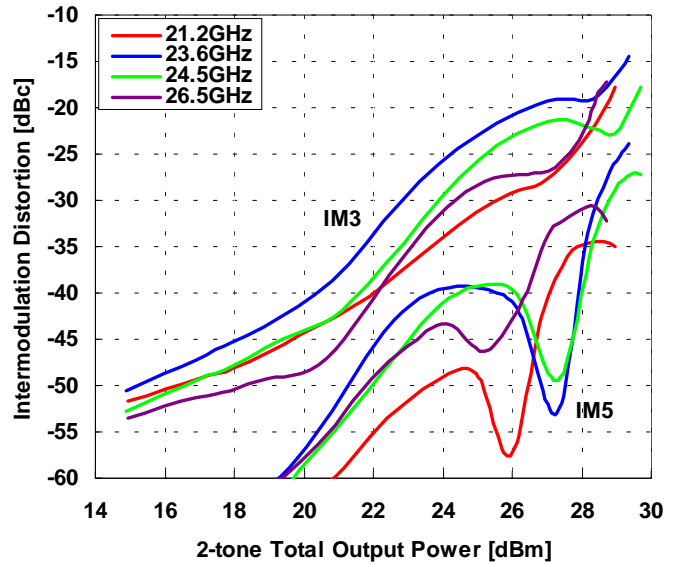

OUTPUT POWER, GAIN vs. DRAIN CURRENT

VDD=6V

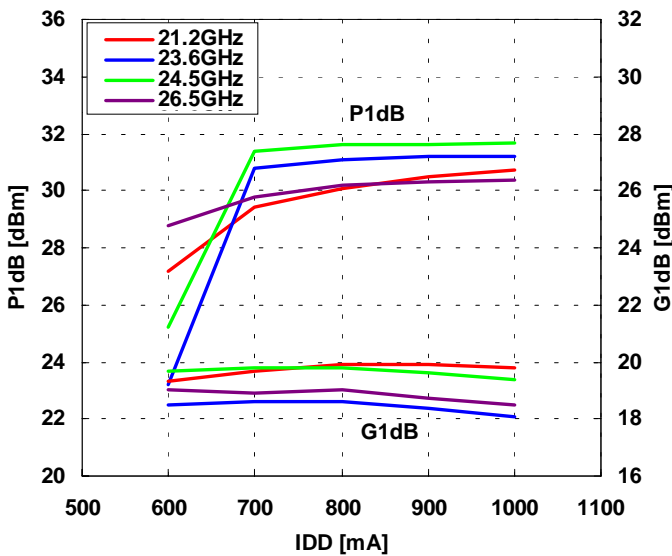

OUTPUT POWER, GAIN vs. DRAIN VOLTAGE

IDD(DC)=800mA

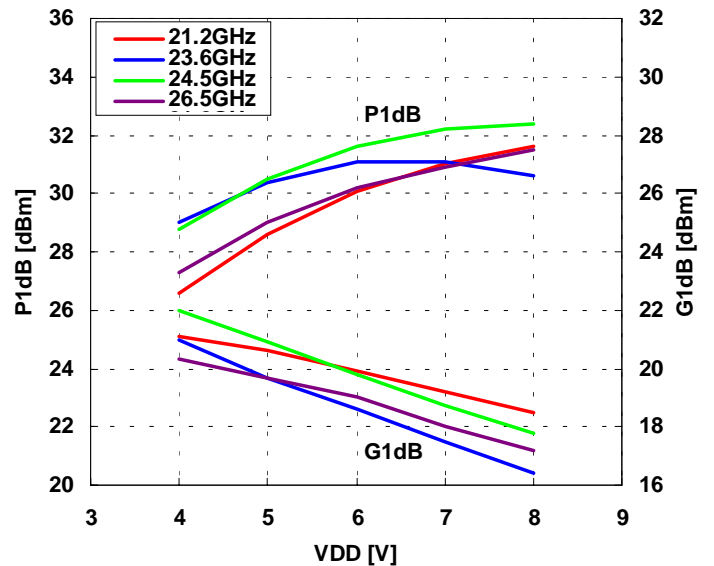

Eudyna

ES/EMM5832VU

K-Band Power Amplifier MMIC

Preliminary

OUTPUT POWER, DRAIN CURRENT
vs. INPUT POWER by Drain Voltage

IDD(DC)=800mA, f=21.2GHz

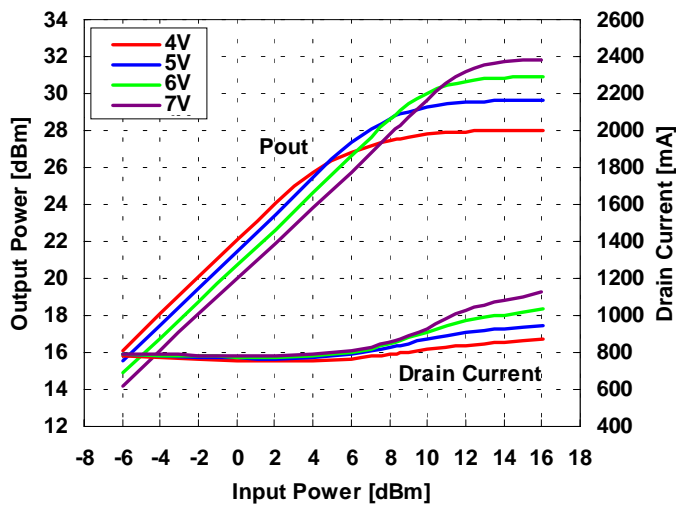

OUTPUT POWER, DRAIN CURRENT
vs. INPUT POWER by Drain Voltage

IDD(DC)=800mA, f=23.6GHz

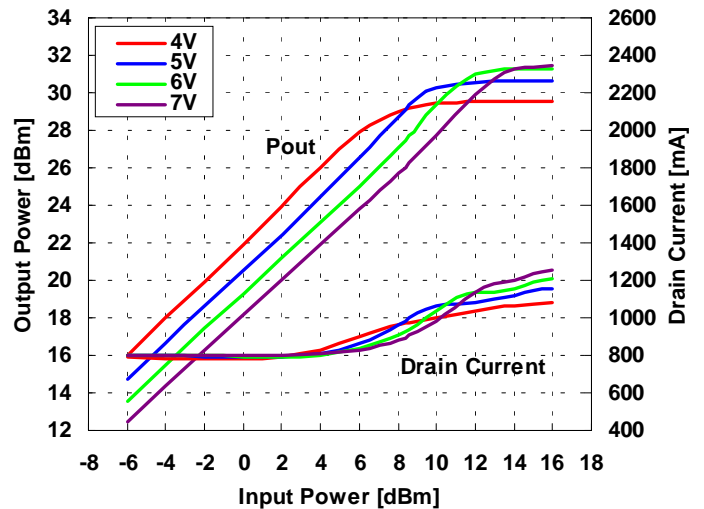

OUTPUT POWER, DRAIN CURRENT
vs. INPUT POWER by Drain Voltage

IDD(DC)=800mA, f=24.5GHz

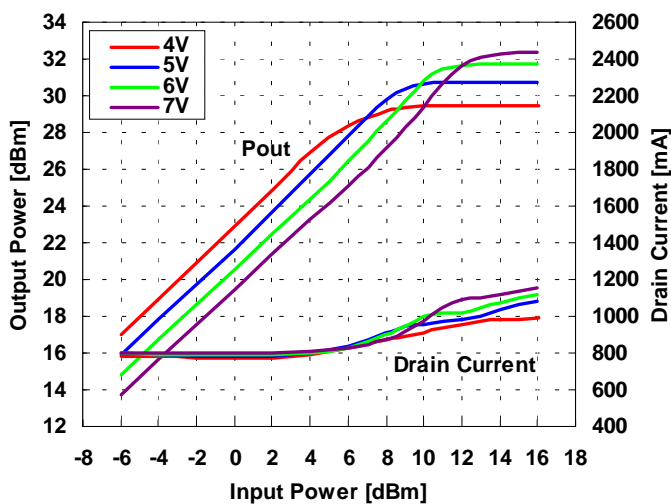

OUTPUT POWER, DRAIN CURRENT
vs. INPUT POWER by Drain Voltage

IDD(DC)=800mA, f=26.5GHz

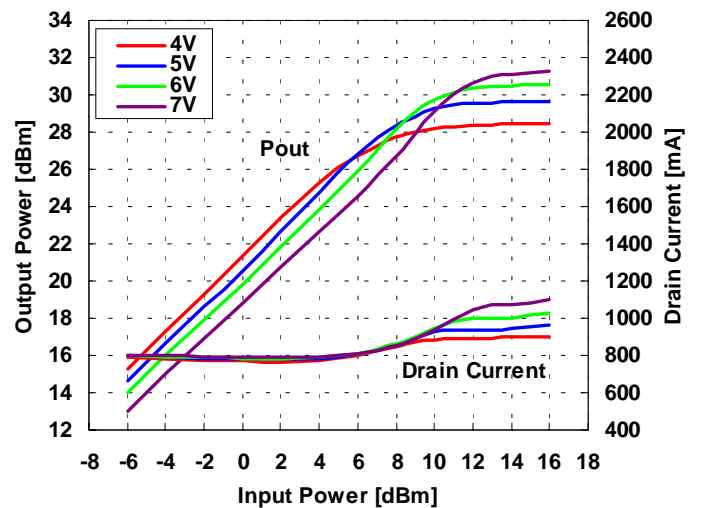

Eudyna

Preliminary

ES/EMM5832VU

K-Band Power Amplifier MMIC

**OUTPUT POWER, DRAIN CURRENT
vs. INPUT POWER by Drain Current**

VDD=6V, f=21.2GHz

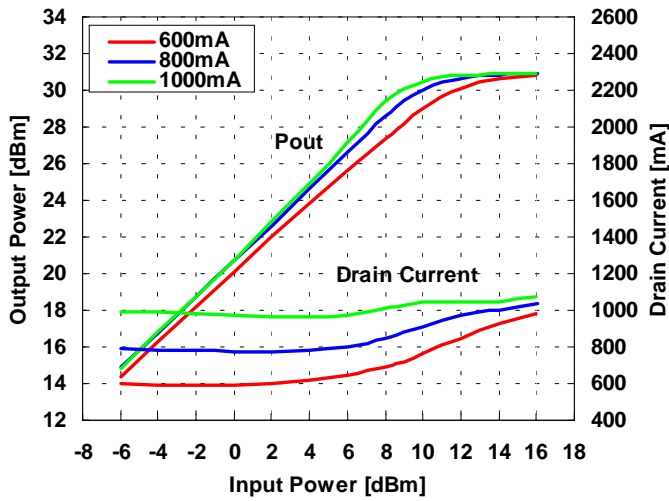

**OUTPUT POWER, DRAIN CURRENT
vs. INPUT POWER by Drain Current**

VDD=6V, f=23.6GHz

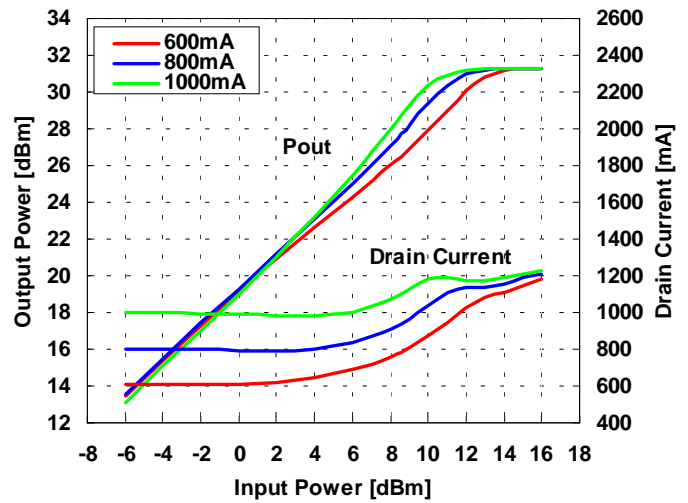

**OUTPUT POWER, DRAIN CURRENT
vs. INPUT POWER by Drain Current**

VDD=6V, f=24.5GHz

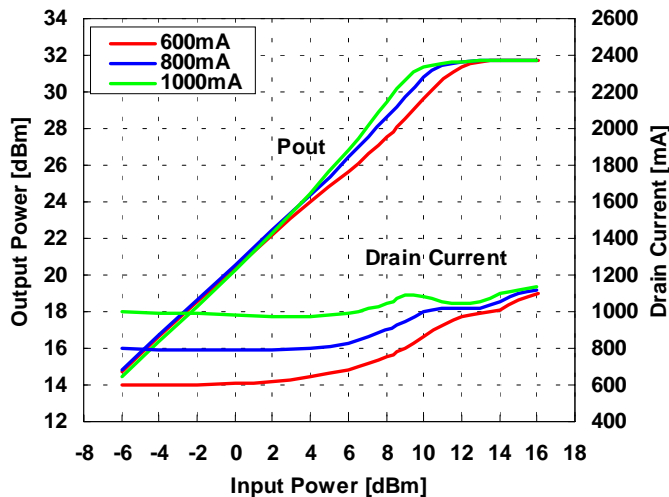

**OUTPUT POWER, DRAIN CURRENT
vs. INPUT POWER by Drain Current**

VDD=6V, f=26.5GHz

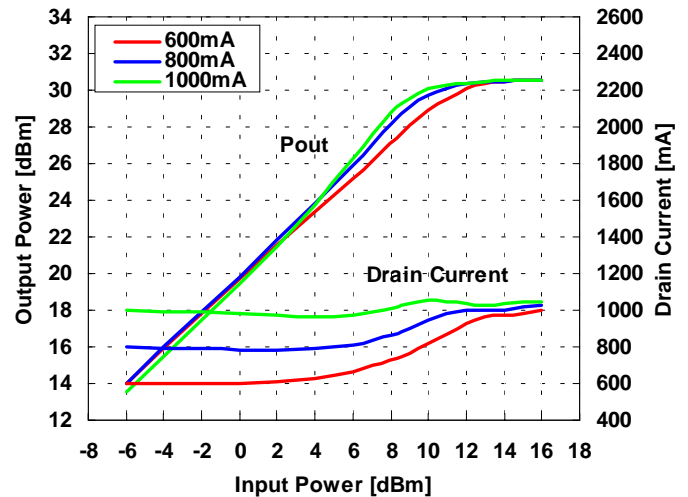

Eudyna

ES/EMM5832VU

K-Band Power Amplifier MMIC

Preliminary

IMD PERFORMANCE vs. OUTPUT POWER
by Drain Voltage

IDD(DC)=800mA, f=21.2GHz

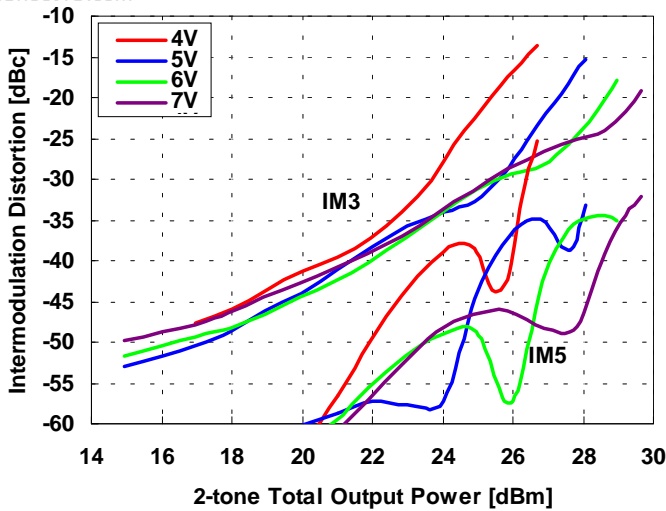

IMD PERFORMANCE vs. OUTPUT POWER
by Drain Voltage

IDD(DC)=800mA, f=23.6GHz

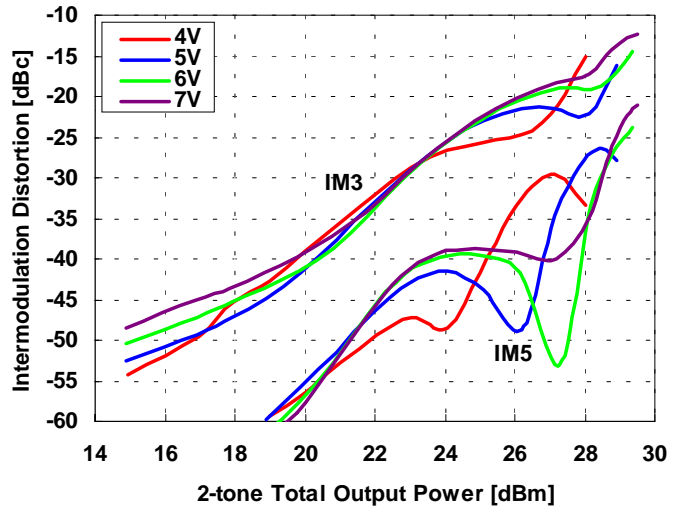

IMD PERFORMANCE vs. OUTPUT POWER
by Drain Voltage

IDD(DC)=800mA, f=24.5GHz

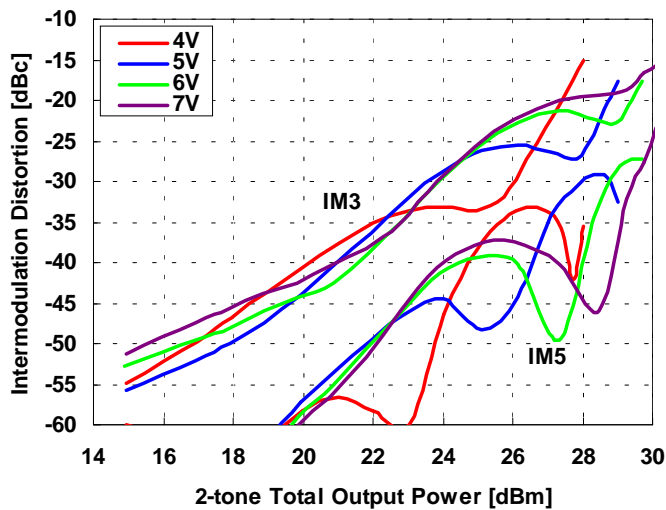

IMD PERFORMANCE vs. OUTPUT POWER
by Drain Voltage

IDD(DC)=800mA, f=26.5GHz

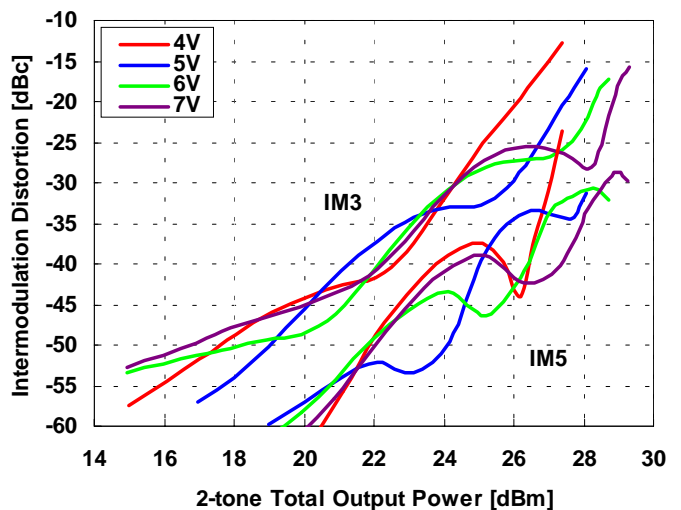

Eudyna

Preliminary

ES/EMM5832VU

K-Band Power Amplifier MMIC

**IMD PERFORMANCE vs. OUTPUT POWER
by Drain Current**
VDD=6V, f=21.2GHz

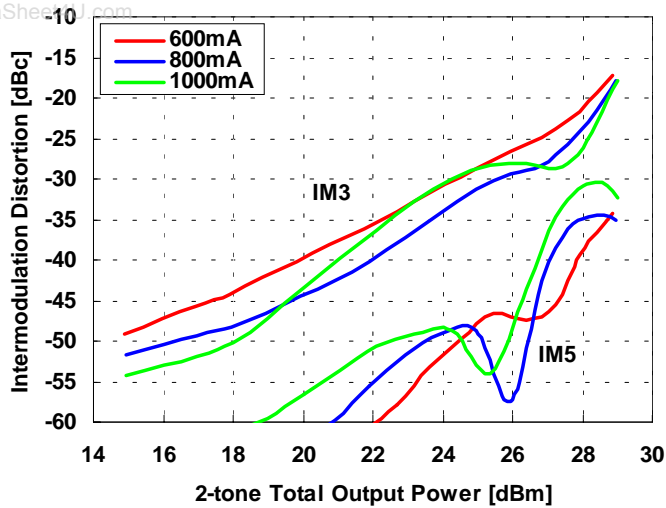

**IMD PERFORMANCE vs. OUTPUT POWER
by Drain Current**
VDD=6V, f=23.6GHz

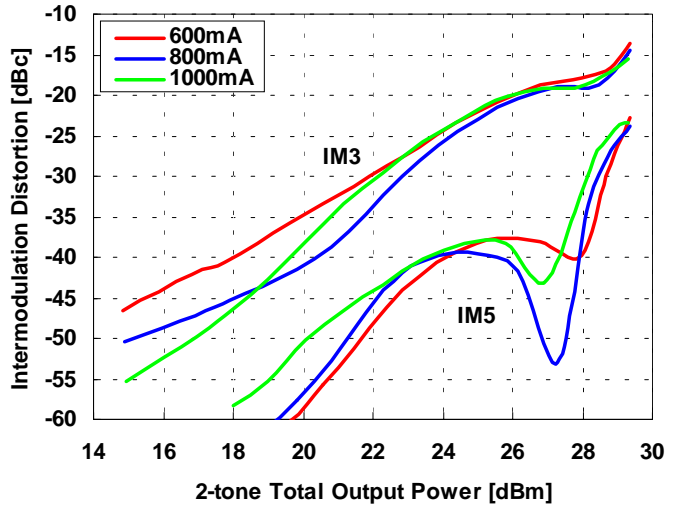

**IMD PERFORMANCE vs. OUTPUT POWER
by Drain Current**
VDD=6V, f=24.5GHz

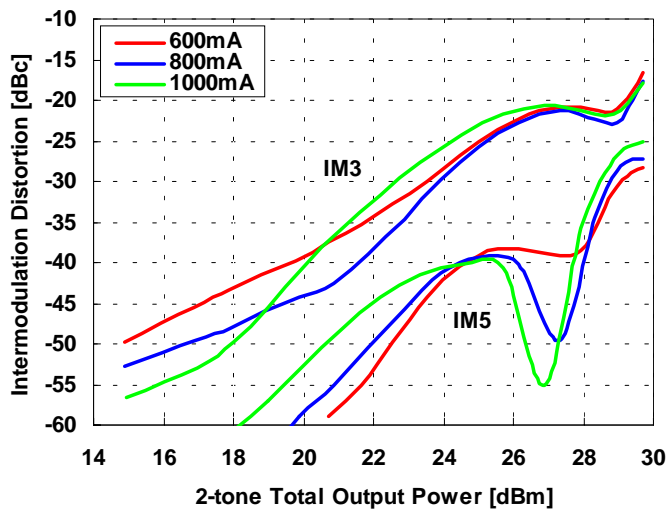

**IMD PERFORMANCE vs. OUTPUT POWER
by Drain Current**
VDD=6V, f=26.5GHz

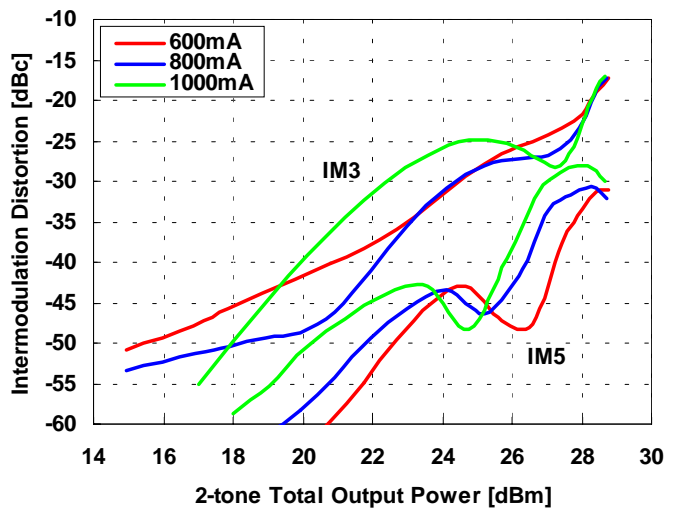

Eudyna

ES/EMM5832VU

Preliminary

K-Band Power Amplifier MMIC

S-PARAMETER

VDD=6V, IDD=800mA

Frequency [GHz]	S11		S21		S12		S22	
	MAG	ANG	MAG	ANG	MAG	ANG	MAG	ANG
1.0	0.98	-32.4	0.01	-30.1	0.00	165.4	0.97	-49.9
2.0	0.93	-62.5	0.02	45.1	0.00	144.3	0.92	-90.2
3.0	0.93	-84.7	0.02	-38.2	0.00	167.6	0.92	-120.7
4.0	0.94	-103.5	0.02	-94.5	0.00	166.4	0.93	-149.6
5.0	0.93	-127.4	0.02	-130.9	0.00	132.8	0.91	174.3
6.0	0.90	-159.1	0.02	-169.6	0.00	102.5	0.88	136.1
7.0	0.89	168.7	0.02	170.9	0.00	14.9	0.89	107.2
8.0	0.89	143.8	0.04	153.3	0.00	-13.0	0.92	84.9
9.0	0.89	121.2	0.10	105.3	0.00	-100.8	0.90	55.4
10.0	0.84	89.4	0.24	47.3	0.00	-158.6	0.87	15.9
11.0	0.80	45.0	0.43	-60.8	0.00	162.8	0.89	-12.3
12.0	0.83	9.7	0.33	-147.1	0.00	-68.9	0.90	-25.2
13.0	0.85	-7.1	0.25	156.4	0.00	-83.4	0.89	-34.6
14.0	0.85	-16.0	0.23	110.3	0.00	-135.2	0.87	-51.2
15.0	0.83	-33.3	0.20	62.6	0.01	-170.4	0.84	-78.8
16.0	0.78	-64.9	0.12	72.6	0.01	115.9	0.83	-105.9
17.0	0.79	-99.5	0.79	67.6	0.00	21.9	0.82	-125.5
18.0	0.81	-120.6	4.02	-21.4	0.00	-82.4	0.77	-142.9
19.0	0.76	-128.6	6.67	-150.4	0.00	-115.8	0.56	-164.7
20.0	0.71	-139.8	8.59	118.6	0.00	174.5	0.27	139.1
21.0	0.52	-175.1	10.65	17.0	0.00	64.8	0.21	-19.6
21.2	0.48	172.6	10.84	-2.4	0.00	22.7	0.23	-34.5
21.4	0.45	159.4	10.99	-22.2	0.00	-26.9	0.24	-49.2
21.6	0.43	145.7	11.12	-41.7	0.00	-102.6	0.25	-66.2
21.8	0.43	133.3	11.17	-61.3	0.00	-157.3	0.27	-86.0
22.0	0.44	120.9	11.06	-80.7	0.00	128.8	0.28	-107.0
22.2	0.45	109.7	10.93	-99.4	0.00	63.7	0.30	-124.3
22.4	0.46	100.0	11.02	-117.8	0.00	20.8	0.34	-139.3
22.6	0.46	91.2	11.12	-136.6	0.00	-0.5	0.39	-152.2
22.8	0.44	84.0	11.12	-157.0	0.00	-12.0	0.46	-164.9
23.0	0.42	77.6	10.93	-176.4	0.00	-34.0	0.51	-176.8
23.2	0.39	72.6	10.63	163.5	0.00	-50.9	0.54	173.3
23.4	0.36	66.2	10.12	145.1	0.00	-57.0	0.53	164.9
23.6	0.32	59.2	9.66	128.0	0.00	-64.5	0.52	160.0
23.8	0.27	50.4	9.53	111.5	0.00	-73.2	0.49	157.5
24.0	0.20	38.1	9.38	95.6	0.00	-73.5	0.47	156.9
24.2	0.14	16.4	9.47	79.2	0.00	-77.1	0.45	158.0
24.4	0.10	-31.6	9.97	62.5	0.00	-70.3	0.45	160.3
24.6	0.13	-93.2	10.88	43.7	0.00	-60.7	0.47	159.0
24.8	0.21	-131.1	11.84	19.9	0.01	-71.2	0.48	151.3
25.0	0.25	-155.7	11.72	-7.8	0.01	-92.4	0.42	140.5
25.2	0.26	-171.8	10.52	-33.0	0.01	-111.0	0.34	135.6
25.4	0.25	179.6	9.21	-53.4	0.01	-126.2	0.28	134.8
25.6	0.24	175.9	8.30	-70.4	0.01	-127.9	0.24	130.5
25.8	0.23	174.3	7.97	-85.2	0.00	-130.5	0.20	121.0
26.0	0.24	172.5	8.12	-101.7	0.00	-136.5	0.15	106.8
26.2	0.25	168.8	8.57	-121.4	0.00	-143.3	0.10	88.6
26.4	0.26	162.7	8.90	-143.6	0.00	-158.3	0.07	61.7
26.6	0.27	154.5	9.23	-167.8	0.00	-165.8	0.05	23.1
26.8	0.28	145.3	9.45	166.6	0.00	-172.7	0.06	-16.6
27.0	0.28	132.0	9.41	137.8	0.00	-165.6	0.07	-50.7
28.0	0.15	-125.7	4.59	-25.6	0.01	96.4	0.21	-173.2
29.0	0.62	-168.9	0.81	-156.4	0.01	-99.6	0.40	-168.3
30.0	0.71	155.4	0.05	150.2	0.01	-179.6	0.56	172.9
31.0	0.64	119.8	0.01	157.7	0.01	-15.9	0.43	158.8
32.0	0.64	88.1	0.01	167.4	0.01	-107.6	0.34	124.5
33.0	0.71	76.0	0.00	-172.0	0.01	-116.2	0.55	81.1
34.0	0.79	67.6	0.00	-164.3	0.01	-133.6	0.69	62.8
35.0	0.72	42.5	0.01	-119.5	0.01	-124.2	0.65	45.5
36.0	0.54	-9.8	0.02	-174.3	0.02	-177.1	0.51	-3.1
37.0	0.61	-49.6	0.03	115.0	0.03	115.8	0.55	-50.8
38.0	0.74	-53.9	0.03	28.5	0.03	24.8	0.66	-59.6
39.0	0.73	-53.6	0.04	-22.8	0.04	-28.7	0.65	-65.9
40.0	0.37	-82.9	0.06	-120.3	0.06	-118.6	0.45	-100.3

Eudyna

Preliminary

ES/EMM5832VU

K-Band Power Amplifier MMIC

S-PARAMETER

VDD=6V, IDD(DC)=800mA

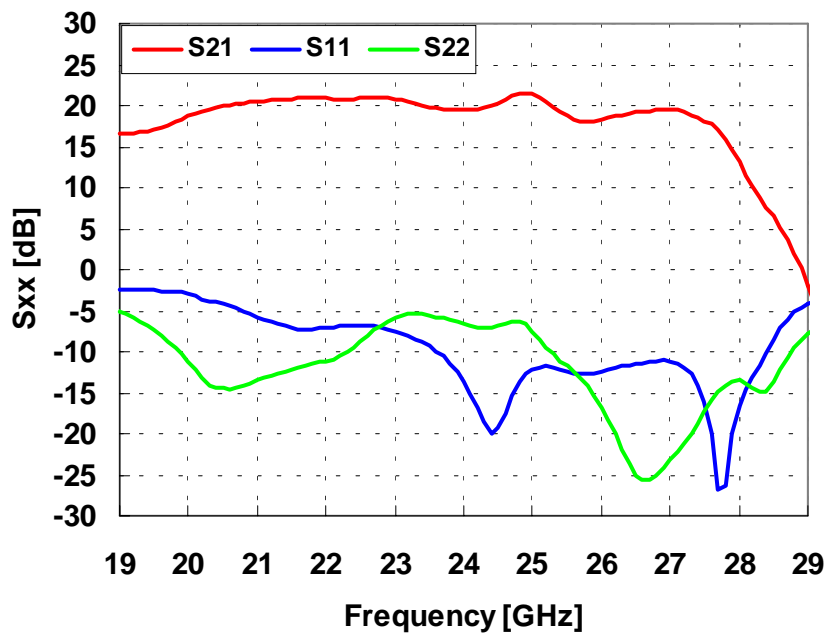
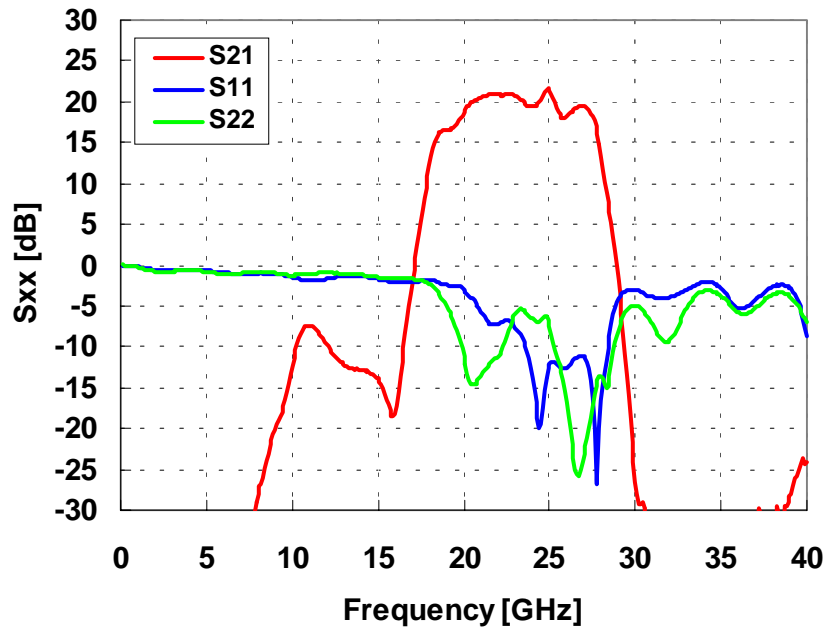

Eudyna

Preliminary

ES/EMM5832VU

K-Band Power Amplifier MMIC

■ Block diagram

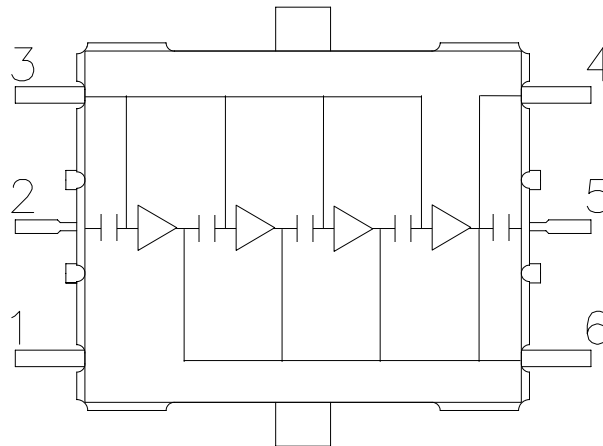

PIN ASSIGNMENT

- 1 : VGG
- 2 : RF in
- 3 : N.C.
- 4 : VDD
- 5 : RF out
- 6 : VDD

■ Recommended Bias Circuit

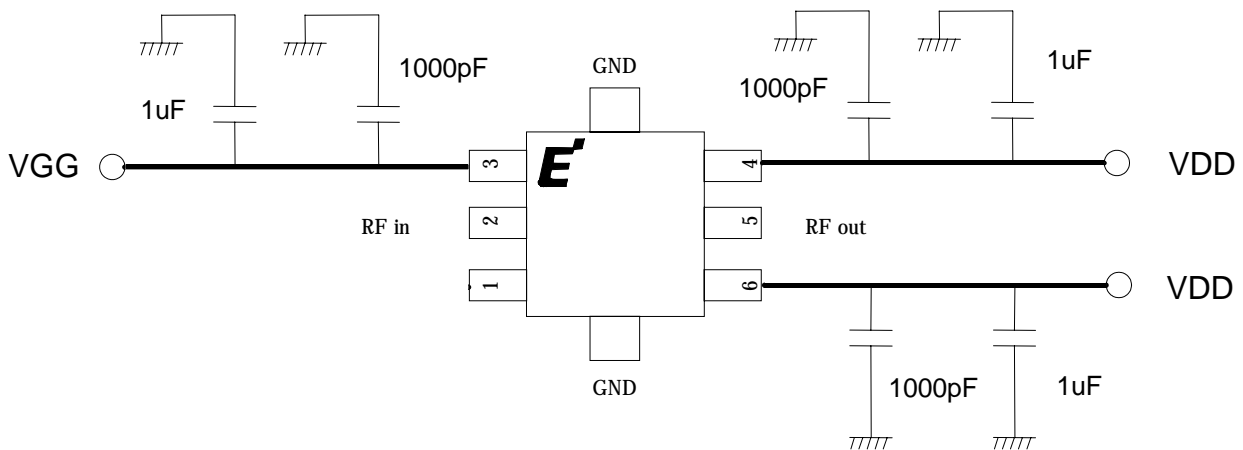

Note 1: The capacitors are recommended on the bias supply line, close to the package, in order to prevent video oscillations which could damage the module.

Note 2: Two pins named VDD are internally connected.

Eudyna

ES/EMM5832VU

Preliminary

K-Band Power Amplifier MMIC

Package Outline

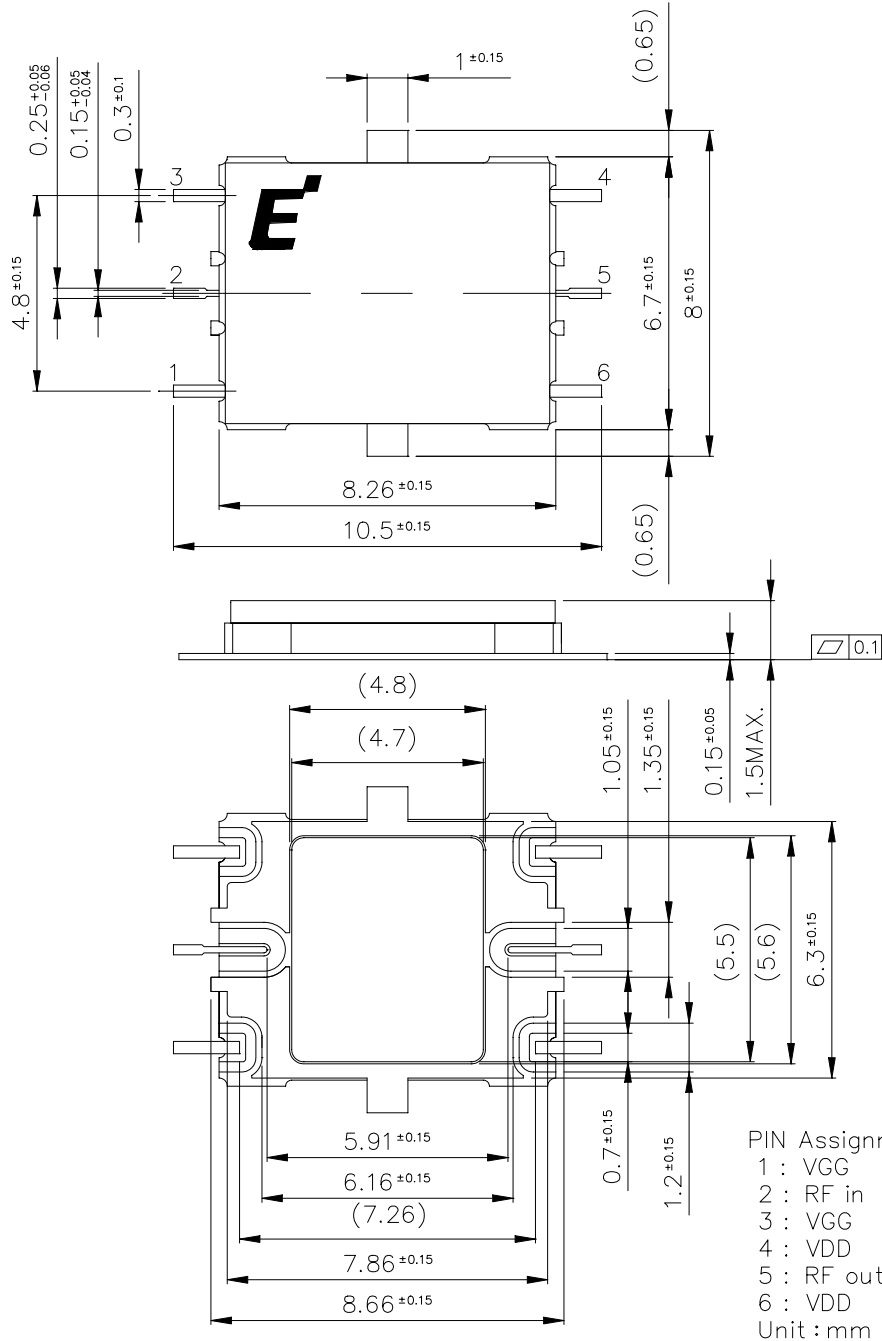

Preliminary

ES/EMM5832VU

K-Band Power Amplifier MMIC

■ PCB Pads and Solder-resist Pattern

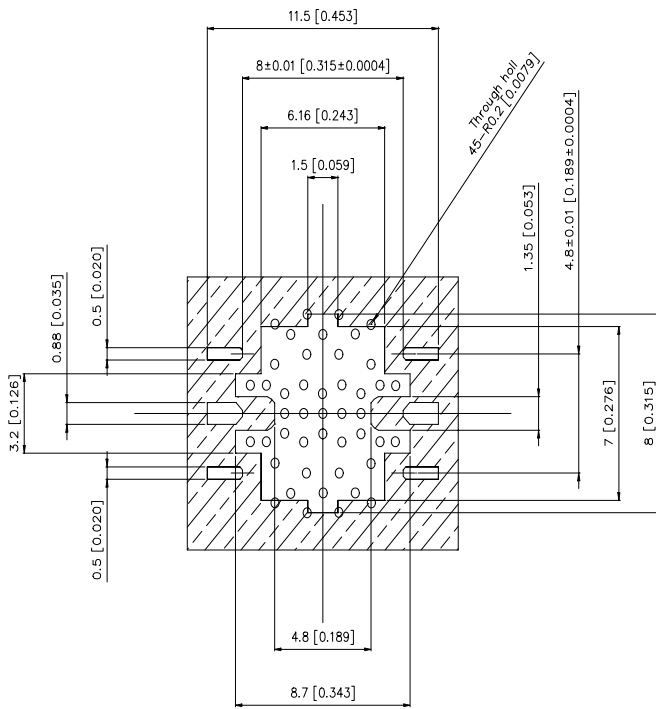

Unit: mm [inches]
PCB: Diclad-522
Under plating: Cu
: Nickel (Ni) 1 ~ 4 μm
Top plating: Gold (Au)
(Flash plating 0.1 μm or less)

 Resist Pattern

Eudyna

ES/EMM5832VU

Preliminary

K-Band Power Amplifier MMIC

For further information please contact :

Eudyna Devices USA Inc.

2355 Zanker Rd.
San Jose, CA 95131-1138, U.S.A.
TEL: (408) 232-9500
FAX: (408) 428-9111
www.us.eudyna.com

Eudyna Devices Europe Ltd.

Network House
Norreys Drive
Maidenhead, Berkshire SL6 4FJ
United Kingdom
TEL: +44 (0) 1628 504800
FAX: +44 (0) 1628 504888

Eudyna Devices Asia Pte. Ltd.

Hong Kong Branch
Rm.1101,Ocean Centre, 5 Canton Road
Tsim Sha Tsui, Kowloon, Hong Kong
TEL: +852-2377-0227
FAX: +852-2377-3921

Eudyna Devices Inc.

Sales Division
1, Kanai-cho, Sakae-ku
Yokohama, 244-0845, Japan
TEL +81-45-853-8156
FAX +81-45-853-8170

CAUTION

Eudyna Devices Inc. products contain **gallium arsenide (GaAs)** which can be hazardous to the human body and the environment. For safety, observe the following procedures:

- Do not put these products into the mouth.
- Do not alter the form of this product into a gas, powder, or liquid through burning, crushing, or chemical processing as these by-products are dangerous to the human body if inhaled, ingested, or swallowed.
- Observe government laws and company regulations when discarding this product. This product must be discarded in accordance with methods specified by applicable hazardous waste procedures.

Eudyna Devices Inc. reserves the right to change products and specifications without notice. The information does not convey any license under rights of Eudyna Devices Inc. or others.

© 2005 Eudyna Devices USA Inc.
Printed in U.S.A.

Eudyna