

EXAMINED BY : <i>Yung Chang Hu</i>	EMERGING DISPLAY TECHNOLOGIES CORPORATION	FILE NO . CAS-51607
APPROVED BY: <i>David Chang</i>		ISSUE : MAY.24, 2007
		TOTAL PAGE : 22
		VERSION : 1

CUSTOMER ACCEPTANCE SPECIFICATIONS

www.DataSheet4U.com

MODEL NO. :

ET057007DMU

(RoHS)

FOR MESSRS :

CUSTOMER'S APPROVAL

DATE :

BY :

EMERGING DISPLAY
TECHNOLOGIES CORPORATION

MODEL NO. ET057007DMU (RoHS)	VERSION 1	PAGE 0-1
---------------------------------	--------------	-------------

RECORDS OF REVISION	DOC . FIRST ISSUE	MAY.24, 2007
---------------------	-------------------	--------------

DATE	REVISED PAGE NO.	SUMMARY

www.Data

TABLE OF CONTENTS

NO.	ITEM	PAGE
1.	GENERAL SPECIFICATIONS -----	1
2.	MECHANICAL SPECIFICATIONS -----	1
3.	ABSOLUTE MAXIMUM RATINGS -----	2
4.	ELECTRICAL CHARACTERISTICS -----	3
5.	TIMING CHART -----	4
6.	OPTICAL CHARACTERISTICS -----	5, 6
7.	OUTLINE DIMENSIONS -----	7
8.	BLOCK DIAGRAM -----	8
9.	DETAIL DRAWING OF DOT MATRIX -----	9
10.	INTERFACE SIGNAL -----	10, 11
11.	POWER SUPPLY -----	12
12.	INSPECTION CRITERION -----	13 ~ 22

1. GENERAL SPECIFICATIONS

1.1 APPLICATION NOTES FOR CONTROLLER/DRIVER

PLEASE REFER TO :

HIMAX HX8250

HIMAX HX8678

1.2 MATERIAL SAFETY DESCRIPTION

ASSEMBLIES SHALL COMPLY WITH EUROPEAN ROHS REQUIREMENTS, INCLUDING PROHIBITED MATERIALS/COMPONENTS CONTAINING LEAD, MERCURY, CADMIUM, HEXAVALENT CHROMIUM, POLYBROMINATED BIPHENYLS (PBB) AND POLYBROMINATED DIPHENYL ETHERS (PBDE)

2. MECHANICAL SPECIFICATIONS

- (1) DISPLAY SIZE (inch) ----- 5.7"
- (2) NUMBER OF DOTS ----- 640W * (RGB) * 480H DOTS
- (3) MODULE SIZE ----- 147.6W * 100.0H * 10.5D mm
(WITHOUT FPC)
- (4) EFFECTIVE AREA ----- 117.2W * 88.4H mm
- (5) ACTIVE AREA ----- 115.2W * 86.4H mm (LCD)
- (6) DOT SIZE ----- 0.06W * 0.18H mm
- (7) PIXEL SIZE ----- 0.18W * 0.18H mm
- (8) LCD TYPE ----- TFT , TRANSMISSIVE
- (9) COLOR ----- 16.7M (24BIT)
- (10) VIEWING DIRECTION ----- 12 O'CLOCK
- (11) BACK LIGHT ----- LED , COLOR : WHITE

3. ABSOLUTE MAXIMUM RATINGS

3.1 ELECTRICAL ABSOLUTE MAXIMUM RATINGS.

PARAMETER	SYMBOL	MIN.	MAX.	UNIT	REMARK
POWER VOLTAGE	VCC	-0.3	7.0	V	VSS=0
INPUT VOLTAGE	V _{in}	-0.3	VCC+0.3	V	
POWER DISSIPATION	PD	—	1.28	W	
FORWARD CURRENT	IF	—	0.06	A	
REVERSE VOLTAGE	VR	—	45	V	

3.2 ENVIRONMENTAL ABSOLUTE MAXIMUM RATINGS.

I T E M	OPERATING		STORAGE		REMARK
	MIN.	MAX.	MIN.	MAX.	
AMBIENT TEMPERATURE	- 2 0 °C	7 0 °C	- 3 0 °C	8 0 °C	NOTE (1) , (2)
HUMIDITY	NOTE (3)		NOTE (3)		WITHOUT CONDENSATION
VIBRATION	—	2.45 m/s ² (0.25 G)	—	11.76 m/s ² (1.2 G)	5~20Hz , 1HR 20~500Hz(20Hz) , 1HR 20~500Hz(500Hz) , 1HR X,Y,Z,TOTAL 3HR
SHOCK	—	29.4 m/s ² (3 G)	—	490 m/s ² (5 0 G)	10 m SECONDS XYZ DIRECTIONS 1 TIME EACH
CORROSIVE GAS	NOT ACCEPTABLE		NOT ACCEPTABLE		

NOTE (1) : Ta AT -30°C : 48HR MAX.
80°C : 168HR MAX.

NOTE (2) : BACKGROUND COLOR CHANGES SLIGHTLY DEPENDING ON AMBIENT TEMPERATURE
THIS PHENOMENON IS REVERSIBLE.

NOTE (3) : Ta ≤ 60°C : 90%RH MAX (96HRS MAX).

Ta > 60°C : ABSOLUTE HUMIDITY MUST BE LOWER THAN THE HUMIDITY
OF 90%RH AT 60°C(96HRS MAX).

4. ELECTRICAL CHARACTERISTICS

Ta = 25 °C

PARAMETER	SYMBOL	CONDITION	MIN.	TYP.	MAX.	UNIT	REMARK
POWER SUPPLY	VCC	—	2.7	3.3	3.6	V	
POWER SUPPLY CURRENT FOR LCM	ICC	VCC = 3.3V LED B/L = ON	—	510	600	mA	
LOW LEVEL INPUT VOLTAGE	VIL	—	0	—	0.3*VCC	V	
HIGH LEVEL INPUT VOLTAGE	VIH	—	0.7*VCC	—	VCC	V	
OUTPUT LOW VOLTAGE	VOL	IOL = 400μA	0	—	0.2*VCC	V	
OUTPUT HIGH VOLTAGE	VOH	IOH = 400μA	0.8*VCC	—	VCC	V	
FRAME FREQUENCY	fFRAME	—	—	60	90	Hz	
FORWARD VOLTAGE	V _F	I _F =40mA	28	30	32	V	
LED LIFE TIME	—	—	30000	40000	—	hr	

5. TIMING CHART

5.1 DIGITAL PARALLEL RGB INTERFACE

SIGNAL	ITEM	SYMBOL	MIN.	TYP.	MAX.	UNIT
DCLK	FREQUENCY	TCLK	—	25.175	—	MHz
	HIGH TIME PULSE DUTY	TCWH	40	50	60	%
DATA	SETUP TIME	TDSU	10	—	—	ns
	HOLD TIME	TDHD	10	—	—	ns
HSYNC	PERIOD	TH	—	800	—	DCLK
	PULSE WIDTH	TWH	5	30	—	DCLK
	BACK-PORCH	THB	—	144	175	DCLK
	DISPLAY PERIOD	THD	—	640	—	DCLK
VSYNC	PERIOD	TV	—	525	—	TH
	PULSE WIDTH	TWV	1	3	5	TH

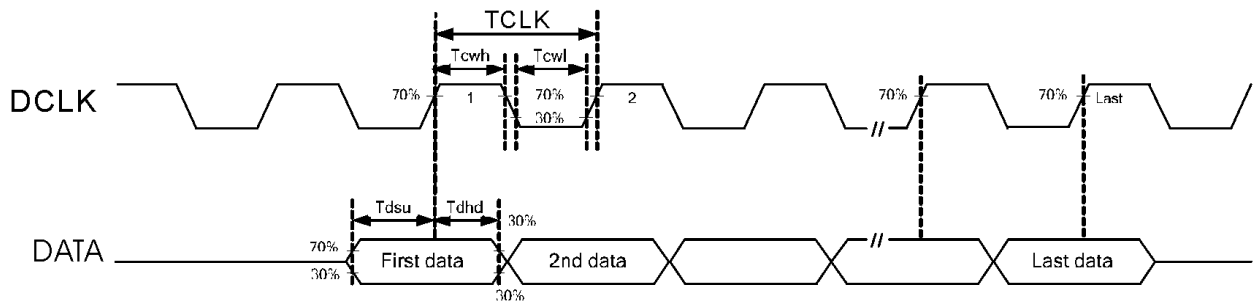
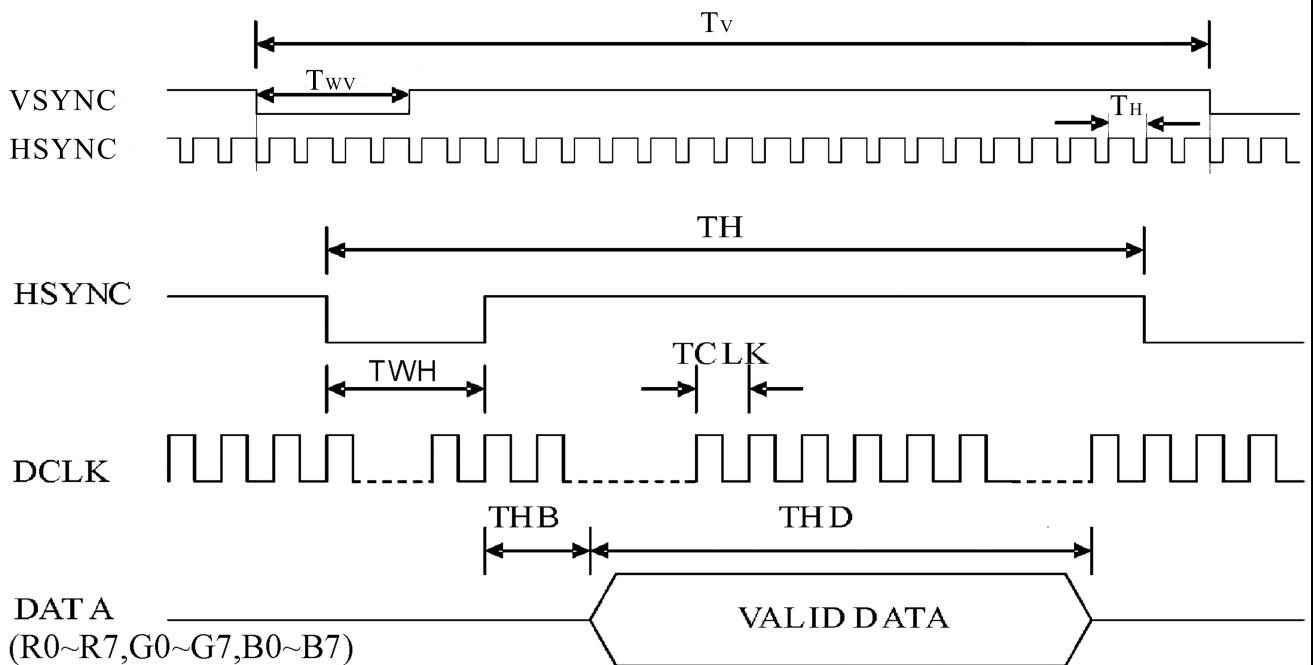

6. OPTICAL CHARACTERISTICS
6.1 OPTICAL CHARACTERISTICS

Ta = 25 ± 2 °C

I T E M		SYMBOL	CONDITION	MIN.	TYP.	MAX.	UNIT	REMARK
VIEWING ANGLE		θ_{y+}	CR ≥ 10	50	55	—	deg.	(2) (3)
		θ_{y-}		47	52	—		
		θ_{x+}		60	65	—		
		θ_{x-}		60	65	—		
CONTRAST RATIO		CR	$\theta_x=0^\circ, \theta_y=0^\circ$	300	350	—	—	(3)
RESPONSE TIME		t r (rise)	$\theta_x=0^\circ, \theta_y=0^\circ$	—	15	30	msec	(4)
		t f (fall)		—	35	50		
THE BRIGHTNESS OF MODULE		B	$\theta_x=0^\circ, \theta_y=0^\circ$ IF = 40mA	400	450	—	cd/m ²	—
COLOR OF CIE COORDINATE	WHITE	x	$\theta_x=0^\circ, \theta_y=0^\circ$ IF = 40mA NTSC : 50 %	0.26	0.31	0.36	—	(5)
		y		0.30	0.35	0.40		
	RED	x		0.56	0.61	0.66	—	—
		y		0.31	0.36	0.41		
	GREEN	x		0.28	0.33	0.38	—	—
		y		0.51	0.56	0.61		
	BLUE	x		0.09	0.14	0.19	—	—
		y		0.07	0.12	0.17		
THE UNIFORMITY OF MODULE		—	—	75	80	—	%	—

NOTE (1) : TEST EQUIPMENT SETUP :

AFTER STABILIZING AND LEAVING THE PANEL ALONE AT A GIVEN TEMPERATURE FOR 30 MINUTES , THE MEASUREMENT SHOULD BE EXECUTED. MEASUREMENT SHOULD BE EXECUTED IN A STABLE , WINDLESS , AND DARK ROOM. OPTICAL SPECIFICATIONS ARE MEASURED BY TOPCON BM-7 (FAST) WITH A VIEWING ANGLE OF 2° AT A DISTANCE OF 50cm AND NORMAL DIRECTION.

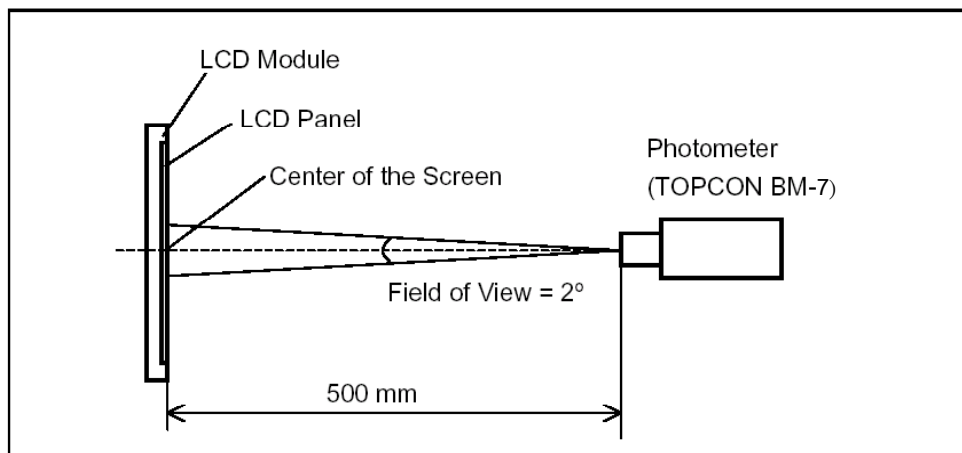

NOTE (2) : DEFINITION OF VIEWING ANGLE :

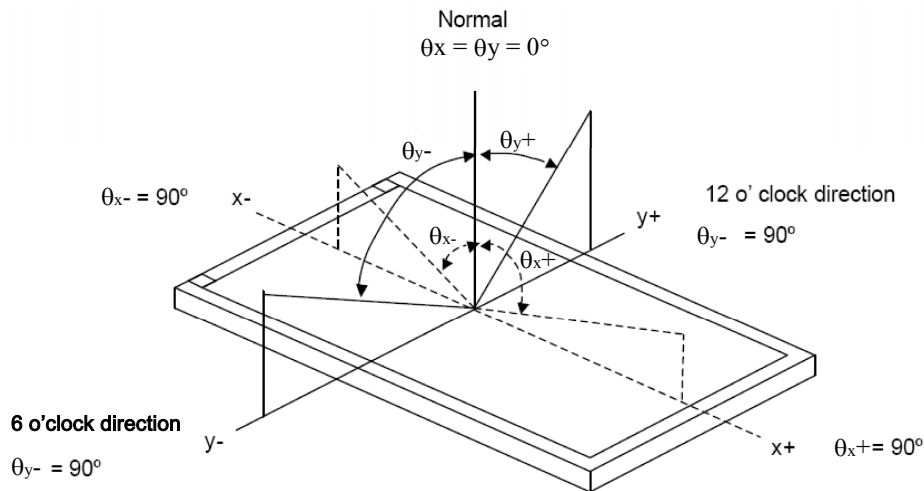

NOTE (3) : DEFINITION OF CONTRAST RATIO :

$$\text{CONTRAST RATIO (CR)} = \frac{\text{BRIGHTNESS MEASURED WHEN LCD IS AT "WHITE STATE"}}{\text{BRIGHTNESS MEASURED WHEN LCD IS AT "BLACK STATE"}}$$

NOTE (4) : DEFINITION OF RESPONSE TIME : TR AND TF

THE FIGURE BELOW IS THE OUTPUT SIGNAL OF THE PHOTO DETECTOR.

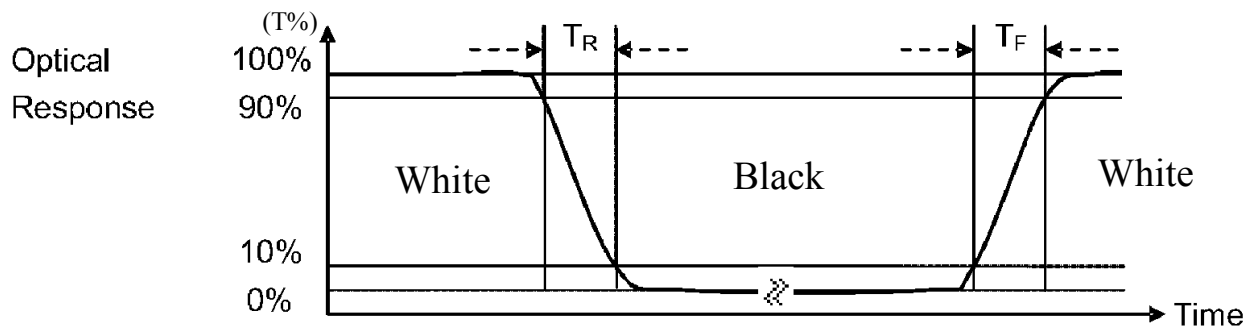

NOTE (5) : THE 100% TRANSMISSION IS DEFINED AS THE TRANSMISSION OF LCD PANEL WHEN ALL THE INPUT TERMINALS OF MODULE ARE ELECTRICALLY OPENED.

6.2 THE TEST METHOD OF BRIGHTNESS AND UNIFORMITY

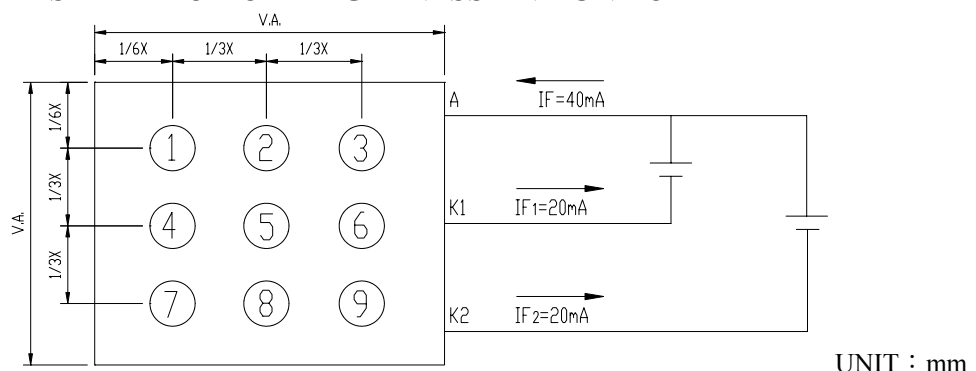

6.3 THE CALCULATING METHOD OF UNIFORMITY

$$\text{UNIFORMITY} = \left[1 - \frac{\text{MAXIMUN BRIGHTNESS} - \text{MINIMUN BRIGHTNESS}}{\text{AVERAGE BRIGHTNESS}} \right] \times 100\%$$

7. OUTLINE DIMENSIONS

VIEWING DIRECTION

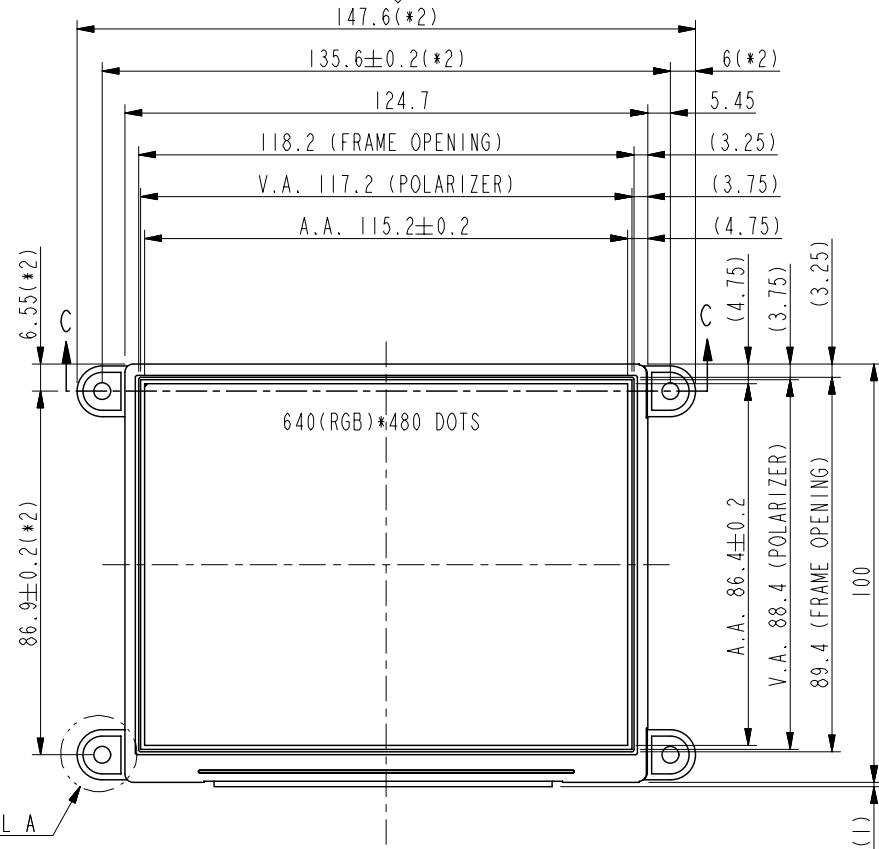

DETAIL A

www.DataSheet4U.com

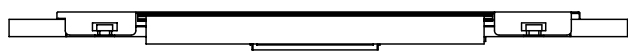

DETAIL B

SECTION C-C

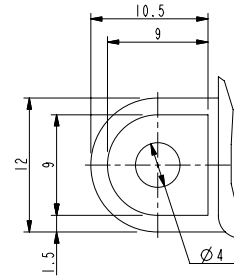

DETAIL A
SCALE 2:1
(*4)

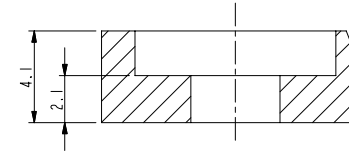

DETAIL B
SCALE 4:1
(*4)

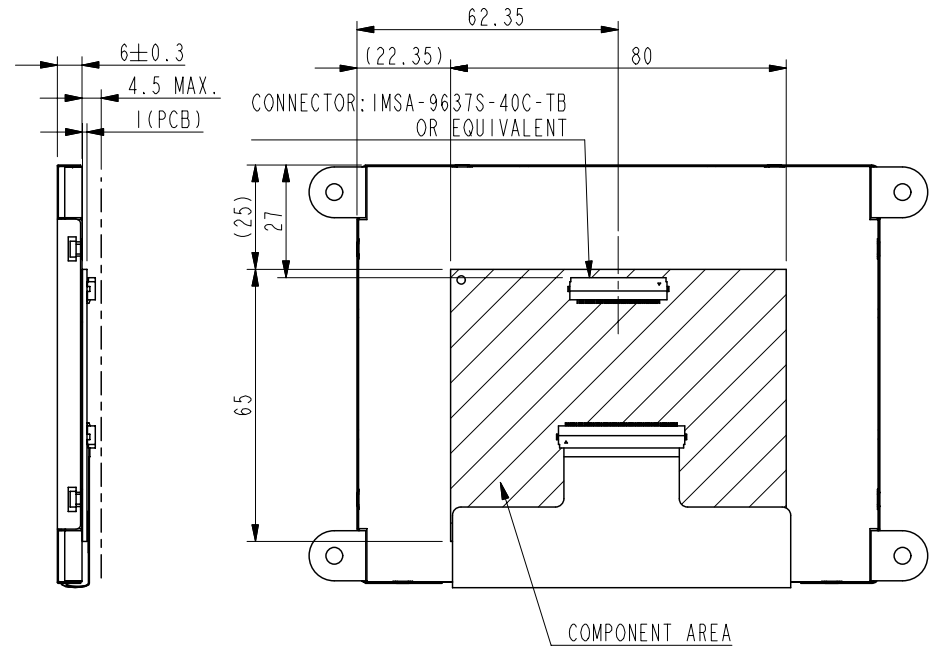

UNIT : mm
SCALE : NTS
NOT SPECIFIED TOLERANCE IS ± 0.5

8. BLOCK DIAGRAM

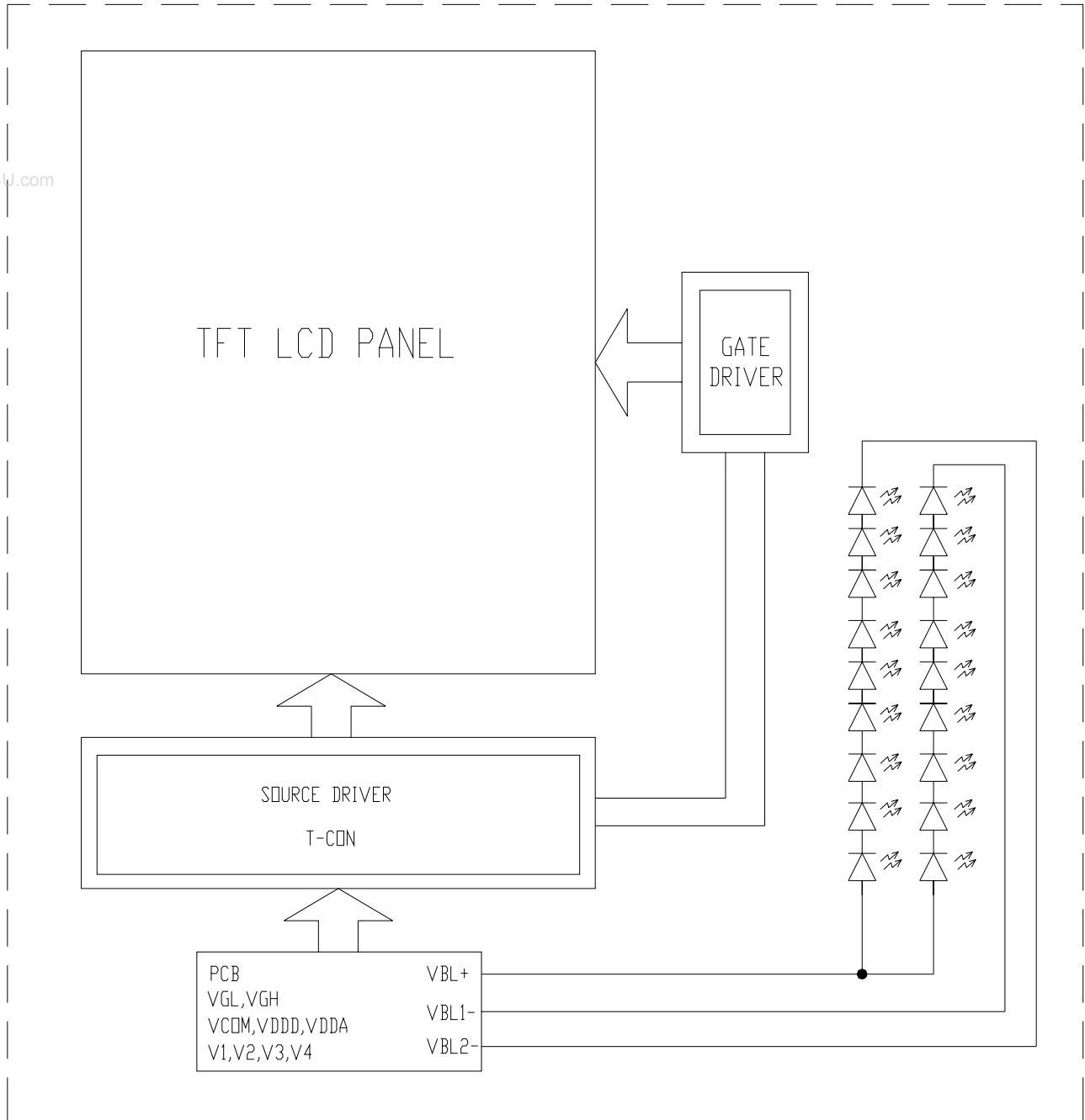

www.DataSheet4U.com

9. DETAIL DRAWING OF DOT MATRIX

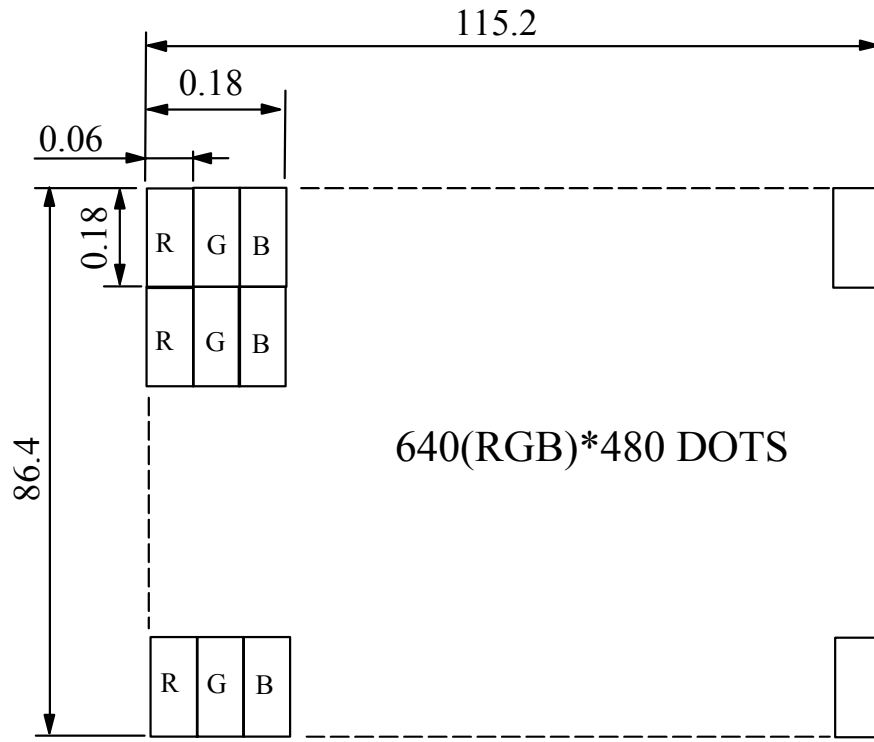

UNIT : mm
SCALE : NTS
NOT SPECIFIED TOLERANCE IS ± 0.1
DOTS MATRIX TOLERANCE IS ± 0.01

10. INTERFACE SIGNALS

PIN NO	SYMBOL	I/O	FUNCTION																
1	LR	I	LR=H:STH→S01→ ---- → S0960 → STHO LR=L:STH→S960→ ---- → S01 → STHO																
2	UD	I	UP/DOWN SCAN SETTING UD=H, REVERSE SCAN UD=L, NORMAL SCAN																
3	VSS	P	GROUND																
4	VCC	P	POWER SUPPLY (3.3V)																
5	VCC	P	POWER SUPPLY (3.3V)																
6	PWCTRL	I	<table border="1"> <thead> <tr> <th></th> <th>PWCTRL</th> <th>LEDCTRL</th> <th>REMARK</th> </tr> </thead> <tbody> <tr> <td>LOGIC LEVEL</td> <td>H</td> <td>H</td> <td>IF = 40mA</td> </tr> <tr> <td>H = 3.3V</td> <td>H</td> <td>L</td> <td>IF = 40mA</td> </tr> <tr> <td>L=0V</td> <td>L</td> <td>L</td> <td>SHUTDOWN</td> </tr> </tbody> </table>		PWCTRL	LEDCTRL	REMARK	LOGIC LEVEL	H	H	IF = 40mA	H = 3.3V	H	L	IF = 40mA	L=0V	L	L	SHUTDOWN
	PWCTRL	LEDCTRL		REMARK															
LOGIC LEVEL	H	H		IF = 40mA															
H = 3.3V	H	L	IF = 40mA																
L=0V	L	L	SHUTDOWN																
7	LEDCTRL	I	<p>* LEDCTRL : WHEN ELDCTRL IS BETWEEN 0 AND 3.3V , ILLNMINATION CAN BE ADJUSTED MANULLY VIA VOLTACE CONTROL.</p>																
8	ENB	I	DATA ENABLE INPUT																
9	VSYNC	I	VERTICAL SYNC INPUT																
10	HSYNC	I	HORIZONTAL SYNC INPUT																
11	DCLK	I	DOT DATA COLOCK																
12	R0	I	RED DATA BIT 0																
13	R1	I	RED DATA BIT 1																
14	R2	I	RED DATA BIT 2																
15	R3	I	RED DATA BIT 3																
16	R4	I	RED DATA BIT 4																
17	R5	I	RED DATA BIT 5																
18	R6	I	RED DATA BIT 6																
19	R7	I	RED DATA BIT 7																
20	G0	I	GREEN DATA BIT 0																
21	G1	I	GREEN DATA BIT 1																
22	G2	I	GREEN DATA BIT 2																
23	G3	I	GREEN DATA BIT 3																
24	G4	I	GREEN DATA BIT 4																
25	G5	I	GREEN DATA BIT 5																
26	G6	I	GREEN DATA BIT 6																
27	G7	I	GREEN DATA BIT 7																
28	B0	I	BLUE DATA BIT 0																
29	B1	I	BLUE DATA BIT 1																

EMERGING DISPLAY
TECHNOLOGIES CORPORATION

MODEL NO .
E T 0 5 7 0 0 7 D M U (RoHS)

VERSION
1

PAGE
11

PIN NO	SYMBOL	I/O	FUNCTION
30	B2	I	BLUE DATA BIT 2
31	B3	I	BLUE DATA BIT 3
32	B4	I	BLUE DATA BIT 4
33	B5	I	BLUE DATA BIT 5
34	B6	I	BLUE DATA BIT 6
35	B7	I	BLUE DATA BIT 7
36	/RESET	I	HARDWARE RESET
37	VSS	P	GROUND
38	NC	—	NC
39	NC	—	NC
40	NC	—	NC

1 1 . POWER SUPPLY
1 1 .1 POWER SUPPLY FOR LCM

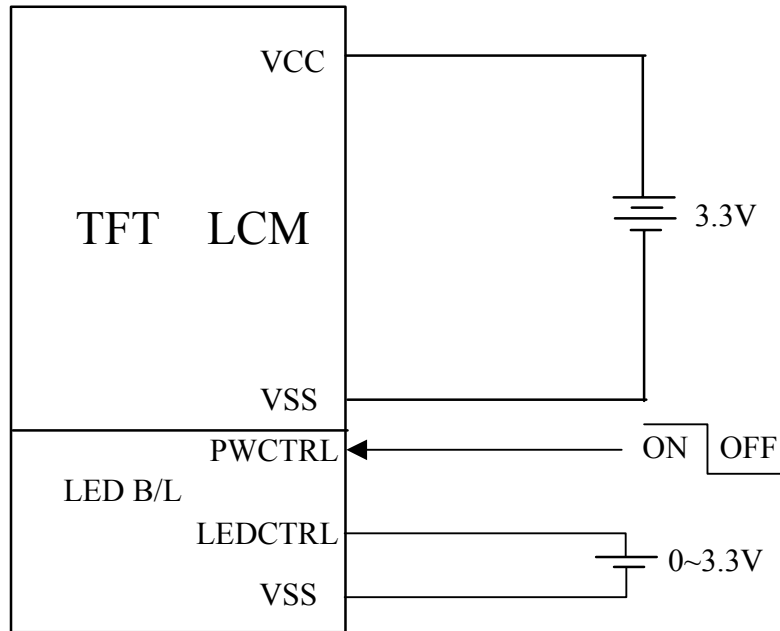

www.DataSheet4U.com

1 2 . INSPECTION CRITERION

12.1 APPLICATION

This inspection standard is to be applied to the LCD module delivered from EMERGING DISPLAY TECHNOLOGIES CORP.(E.D.T) to customers

12.2 INSPECTION CONDITIONS

12.2.1 (1)Observation Distance : 35cm±5cm

(2)View Angle :

Non-operation Condition : ±5°(perpendicular to LCD panel surface)

Operation Condition : ±45° (perpendicular to LCD panel surface)

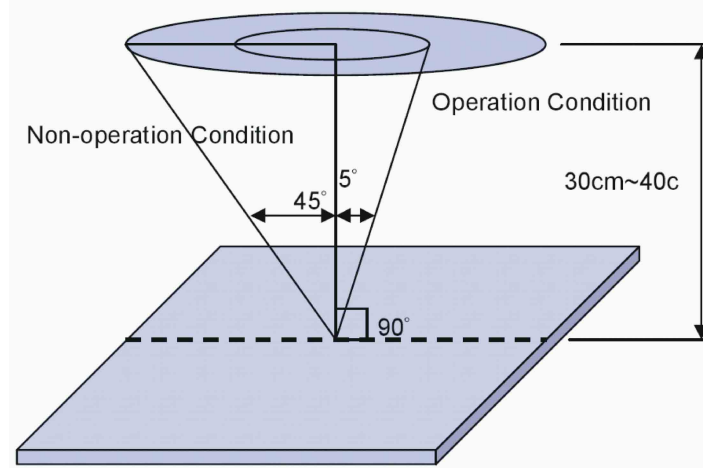

12.2.2 Environment Conditions :

Ambient Temperature		20°C~25°C
Ambient Humidity		65±20%RH
Ambient Illumination	Cosmetic Inspection	More than 600Lux
	Functional Inspection	300~500 Lux

12.2.3 Inspection lot

Quantity per delivery lot for each model

12.2.4 Inspection method

A sampling inspection shall be made according to the following provisions to judge The acceptability

(a)Applicable standard : MIL-STD-105E

Normal inspection , single sampling

Level II

(b)AQL : Major defect : AQL 0.65%

Minor defect : AQL 1.0%

12.3 INSPECTION STANDARDS

12.3.1 VISUAL DEFECTS CLASSIFICATION

TYPE OF DEFECT	INSPECTION ITEM	DEFECT FEATURE	AQL
MAJOR DEFECT	1.DISPLAY ON	<ul style="list-style-type: none"> • DEFECT TO MISS SPECIFIED DISPLAY FUNCTION, FOR ALL AND SPECIFIED DOTS EX: DISCONNECTION, SHORT CIRCUIT ETC 	0.65
	2.BACKLIGHT	<ul style="list-style-type: none"> • NO LIGHT • FLICKERING AND OTHER ABNORMAL ILLUMINATION 	
	3.DIMENSIONS	<ul style="list-style-type: none"> • SUBJECT TO INDIVIDUAL ACCEPTANCE SPECIFICATIONS 	
MINOR DEFECT	1.DISPLAY ZONE	<ul style="list-style-type: none"> • BLACK/WHITE SPOT • BUBBLES ON POLARIZER • NEWTON RING • BLACK/WHITE LINE • SCRATCH • CONTAMINATION • LEVER COLOR SPREED 	1.0
	2.BEZEL ZONE	<ul style="list-style-type: none"> • STAINS • SCRATCHES • FOREIGN MATTER 	
	3.SOLDERING	<ul style="list-style-type: none"> • INSUFFICIENT SOLDER • SOLDERED IN INCORRECT POSITION • CONVEX SOLDERING SPOT • SOLDER BALLS • SOLDER SCRAPS 	
	4.DISPLAY ON (ALL ON)	<ul style="list-style-type: none"> • LIGHT LINE 	

12.3.2 MODULE DEFECTS CALSSIFICATION

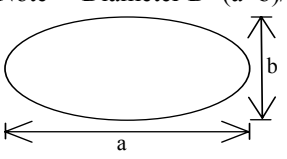
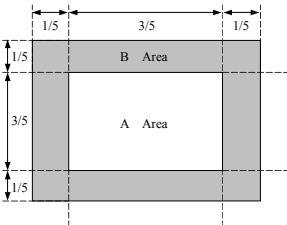
NO.	ITEM	CRITERIA																				
1.	DISPLAY ON INSPECTION	(1)INCORRECT PATTERN (2)MISSING SEGMENT (3)DIM SEGMENT (4)OPERATING VOLTAGE BEYOND SPEC																				
2.	OVERALL DIMENSIONS	(1)OVERALL DIMENSION BEYOND SPEC																				
3.	BLACK SPOTS, FOREIGN MATTER, AND WHITE SPOTS (INCLUDING LIGHT LEAKAGE DUE TO POLARIZING PLATES PINHOLES, ETC.)	<p>(1) SPOTS</p> <table border="1"> <thead> <tr> <th>AVERAGE DIAMETER (mm): D</th> <th>NUMBER OF PIECES PERMITTED</th> <th>MINIMUM SPACE</th> </tr> </thead> <tbody> <tr> <td>D≤0.2</td> <td>IGNORE</td> <td>—</td> </tr> <tr> <td>0.2<D≤0.4</td> <td>5</td> <td>10 mm</td> </tr> <tr> <td>0.4<D</td> <td>0</td> <td></td> </tr> </tbody> </table> <p>NUMBER OF TOTAL PIECES IS TO BE SET WITHIN 5 PIECES. NOTE : THAT WHEN THERE ARE 2 PIECES OR MORE, THEY ARE NOT TO BE CONSIDERED AS CONCENTRATED.</p> <p>(2) BLURRY SPOTS (WHEN FULLY POWERED-ON)</p> <table border="1"> <thead> <tr> <th>AVERAGE DIAMETER (mm): D</th> <th>NUMBER OF PIECES PERMITTED</th> </tr> </thead> <tbody> <tr> <td>D≤0.3</td> <td>IGNORE</td> </tr> <tr> <td>0.3<D≤0.75</td> <td>5</td> </tr> <tr> <td>0.75<D</td> <td>0</td> </tr> </tbody> </table> <p>Note : Diameter D=(a+b)/2</p>  <p>NUMBER OF TOTAL PIECES IS TO BE SET WITHIN 5 PIECES. NOTE : THAT WHEN THERE ARE 2 PIECES OR MORE, THEY ARE NOT TO BE CONSIDERED AS CONCENTRATED.</p>	AVERAGE DIAMETER (mm): D	NUMBER OF PIECES PERMITTED	MINIMUM SPACE	D≤0.2	IGNORE	—	0.2<D≤0.4	5	10 mm	0.4<D	0		AVERAGE DIAMETER (mm): D	NUMBER OF PIECES PERMITTED	D≤0.3	IGNORE	0.3<D≤0.75	5	0.75<D	0
AVERAGE DIAMETER (mm): D	NUMBER OF PIECES PERMITTED	MINIMUM SPACE																				
D≤0.2	IGNORE	—																				
0.2<D≤0.4	5	10 mm																				
0.4<D	0																					
AVERAGE DIAMETER (mm): D	NUMBER OF PIECES PERMITTED																					
D≤0.3	IGNORE																					
0.3<D≤0.75	5																					
0.75<D	0																					
4.	BLACK LINE WHITE LINE NON-DISPLAY	(1)THE BLACK LINE, WHITE LINE ARE WITHIN THE VIEWING AREA. IT IS NOT ALLOW.																				
5.	BLACK LINE WHITE LINE ON-DISPLAY	<p>(1) THE FOLLOWING BLACK LINE , WHITE LINE ARE WITHIN THE VIEWING AREA. WIDTH :Wmm , LENGH :Lmm</p> <table border="1"> <thead> <tr> <th>LENGTH : L</th> <th>WIDTH : W</th> <th>PERMISSIBLE NO.</th> </tr> </thead> <tbody> <tr> <td>L ≤ 0.5</td> <td>W ≤ 0.1</td> <td>IGNORE</td> </tr> <tr> <td>0.5 < L ≤ 2.5</td> <td>0.1 < W ≤ 0.3</td> <td>4</td> </tr> <tr> <td>2.5 < L</td> <td>0.3 ≤ W</td> <td>NONE</td> </tr> </tbody> </table>	LENGTH : L	WIDTH : W	PERMISSIBLE NO.	L ≤ 0.5	W ≤ 0.1	IGNORE	0.5 < L ≤ 2.5	0.1 < W ≤ 0.3	4	2.5 < L	0.3 ≤ W	NONE								
LENGTH : L	WIDTH : W	PERMISSIBLE NO.																				
L ≤ 0.5	W ≤ 0.1	IGNORE																				
0.5 < L ≤ 2.5	0.1 < W ≤ 0.3	4																				
2.5 < L	0.3 ≤ W	NONE																				
6.	SCRATCHES AND DENT ON GLASS POLARIZER	(1) PLS REFER TO THE ABOVE NO.3 AND 4 TO DETERMINE SCRATCHES AND DENT ON POLARIZER OR GLASS																				
7.	DOT DEFECT ON DISPLAY	<p>Judgment Criteria</p> <table border="1"> <thead> <tr> <th>Area</th> <th>Bright Dot</th> <th>Dark Dot</th> <th>Total</th> </tr> </thead> <tbody> <tr> <td>A</td> <td>3</td> <td>3</td> <td>4</td> </tr> <tr> <td>B</td> <td>5</td> <td>5</td> <td>5</td> </tr> </tbody> </table> <p>(1)It is defined as Point Defect if defect area>0.5dot (2)It is ignored if defect area≤0.5dot (3)Weak point defect will be defined as Bright Dot if it can be observed through ND filter 6% (4)The distance between 2 dot defect≥5mm (5)Not Allowed Joint point defect</p> <p>Note : A/B Area Definition</p> 	Area	Bright Dot	Dark Dot	Total	A	3	3	4	B	5	5	5								
Area	Bright Dot	Dark Dot	Total																			
A	3	3	4																			
B	5	5	5																			

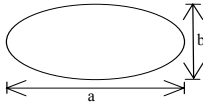
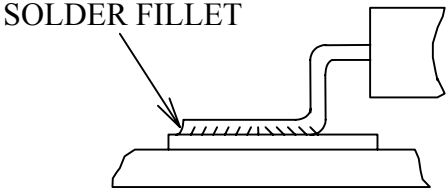
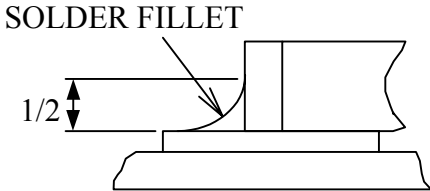
NO.	ITEM	CRITERIA								
8	LINE DEFECT ON DISPLAY	OBVIOUS VERTICAL OR HORIZONTAL LINE DEFECT IS NOT ALLOW								
9	MURA ON DISPLAY	IT'S OK IF MURA IS SLIGHT VISIBLE THROUNG 6% ND FILTER								
10	CF FAIL/SPOT ON DISPLAY	(1)THE FOLLOWING CF FAIL , SPOT ARE WITHIN THE VIEWING AREA								
		<table border="1"> <thead> <tr> <th>SIZE D</th> <th>PERMISSIBLE NO.</th> </tr> </thead> <tbody> <tr> <td>$D \leq 0.15\text{mm}$</td> <td>IGNORED</td> </tr> <tr> <td>$0.15\text{mm} < D \leq 0.2\text{mm}$</td> <td>$N \leq 2$</td> </tr> <tr> <td>$D > 0.2\text{mm}$</td> <td>NOT ALLOWED</td> </tr> </tbody> </table>	SIZE D	PERMISSIBLE NO.	$D \leq 0.15\text{mm}$	IGNORED	$0.15\text{mm} < D \leq 0.2\text{mm}$	$N \leq 2$	$D > 0.2\text{mm}$	NOT ALLOWED
		SIZE D	PERMISSIBLE NO.							
		$D \leq 0.15\text{mm}$	IGNORED							
$0.15\text{mm} < D \leq 0.2\text{mm}$	$N \leq 2$									
$D > 0.2\text{mm}$	NOT ALLOWED									
Note : Diameter $D=(a+b)/2$										
										
11	UNEVEN COLOR SPREAD , COLORATION	(1)TO BE DETERMINED BASED UPON THE STANDARD SAMPLE.								
12	BEZEL APPEARANCE	(1)BEZEL MAY NOT HAVE RUST, E DEFORMED OR HAVE FINGER PRINTS STAINS OF OTHER CONTAMINATION. (2)BEZEL MUST COMPLY WITH JOB SPECIFICATIONS.								
13	SOLDERING	(1)NO SOLDERING FOUND ON THE SPECIFIED PLACE (2)INSUFFICIENT SOLDER								
		<p>(a)LSI, IC A POOR WETTING OF SOLDER IS BETWEEN LOWER BEND OR "HEEL" OF LEAD AND PAD</p>  <p>(b)CHIP COMPONENT · SOLDER IS LESS THAN 50% OF SIDES AND FRONT FACE WETTING</p> 								

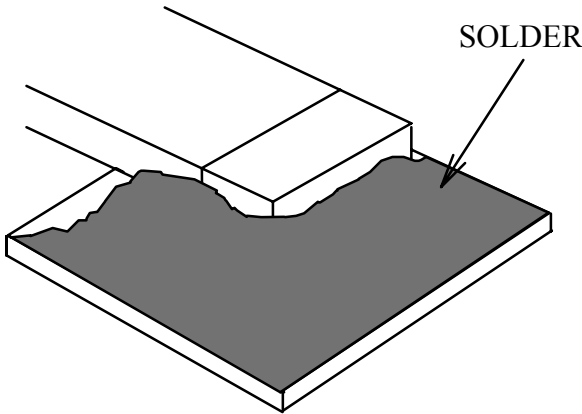
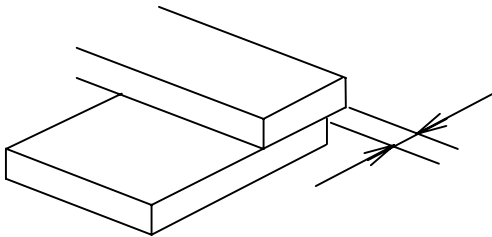
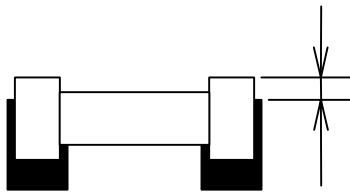
NO.	ITEM	CRITERIA
13.	SOLDERING	<ul style="list-style-type: none"> • SOLDER WETS 3 SIDES OF TERMINAL, BUT LESS THAN 25% OF SIDES AND FRONT SURFACE AREA ARE COVERED  <p>(3)PARTS ALIGMENT</p> <p>(a)LSI, IC LEAD WIDTH IS MORE THAN 50% BEYOND PAD OUTLINE</p>  <p>(b)CHIP COMPONENT COMPONENT IS OFF CENTER, AND MORE THAN 50% OF THE LEADS IS OFF THE PAD OUTLINE</p> 

NO.	ITEM	CRITERIA
13.	SOLDERING	(4)NO UNMELTED SOLDER PASTE MAY BE PRESENT ON THE PCB. (5)NO COLD SOLDER JOINTS, MISSING SOLDER CONNECTIONS, OXIDATION OR ICICLE. (6)NO RESIDUE OR SOLDER BALLS ON PCB. (7)NO SHORT CIRCUITS IN COMPONENTS ON PCB.
14.	BACKLIGHT	(1)NO LIGHT (2)FLICKERING AND OTHER ABNORMAL ILLUMINATION (3)SPOTS OR SCRATCHES THAT APPEAR WHEN LIT MUST BE JUDGED USING LCD SPOT, LINES AND CONTAMINATION STANDARDS. (4)BACKLIGHT DOESN'T LIGHT OR COLOR IS WRONG.
15.	GENERAL APPEARANCE	(1)NO OXIDATION,CONTAMINATION, URVES OR,BENDS ON INTERFACE PIN (OLB) OF TCP. (2)NO CRACKS ON INTERFACE PIN (OLB) OF TCP. (3)NO CONTAMINATION, SOLDER RESIDUE OR SOLDER BALLS ON PRODUCT. (4)THE IC ON THE TCP MAY NOT BE DAMAGED, CIRCUITS. (5)THE UPPERMOST EDGE OF THE PROTECTIVE STRIP ON THE INTERFACE PIN MUST BE PRESENT OR LOOK AS IF IT CAUSE THE INTERFACE PIN TO SEVER. (6)THE RESIDUAL ROSIN OR TIN OIL OF SOLDERING (COMPONENT OR CHIP COMPONENT) IS NOT BURNED INTO BROWN OR BLACK COLOR. (7)SEALANT ON TOP OF THE ITO CIRCUIT HAS NOT HARDENED. (8)PIN TYPE MUST MATCH TYPE IN SPECIFICATION SHEET. (9)LCD PIN LOOSE OR MISSING PINS. (10)PRODUCT PACKAGING MUST THE SAME AS SPECIFIED ON PACKAGING SPECIFICATION SHEET. (11)PRODUCT DIMENSION AND STRUCTURE MUST CONFORM TO PRODUCT SPECIFICATION SHEET. (12)THE APPEARANCE OF HEAT SEAL SHOULD NOT ADMIT ANY DIRT AND BREAK.

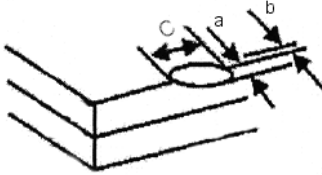
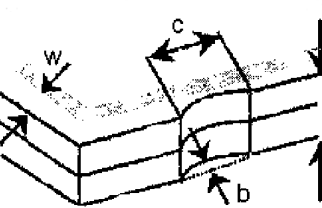
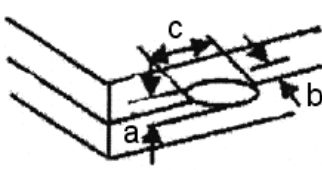
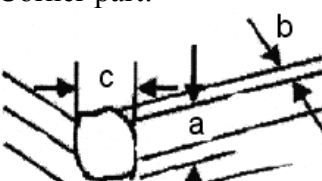
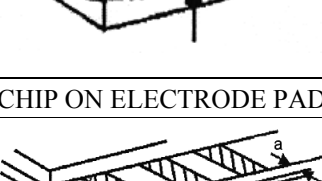
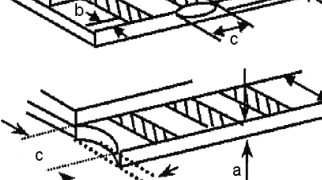
NO.	ITEM	CRITERIA				
16.	CRACKED GLASS	THE LCD WITH EXTENSIVE CRACK IS NOT ACCEPTABLE				
		General glass chip :	a	b	c	
			$\leq t/2$	< VIEWING AREA	$\leq 1/8X$	
			$t/2 > , \leq 2t$	$\leq W/2$	$\leq 1/8X$	
			Corner part:	a	b	c
			$\leq t/2$	< VIEWING AREA	$\leq 1/8X$	
		$> t/2 , \leq 2t$	$\leq W/2$	$\leq 1/8X$	*W=DISTANCE BETWEEN SEALANT AREA AND LCD PANEL EDGE. X = LCD SIDE LENGTH t = GLASS THICKNESS	
		CHIP ON ELECTRODE PAD	a	b		c
			$\leq t$	$\leq 0.5\text{mm}$	$\leq 1/8X$	
			$\leq t$	$\leq 1/8X$	$\leq L$	
	* X=LCD SIDE WIDTH	t = GLASS THICKNESS	L=ELECTRODE PAD LENGTH			
	①IF GLASS CHIPPING THE ITO TERMINAL, OVER 2/3 OF THE ITO MUST REMAIN AND BE , INSPECTED ACCORDING TO ELECTRODE TERMINAL SPECIFICATIONS ②IF THE PRODUCT WILL BE HEAT SEALED BY THE CUSTOMER, THE ALIGNMENT MARK MUST NOT BE DAMAGED					

12.4 RELIABILITY TEST

12.4.1 STANDARD SPECIFICATIONS FOR RELIABILITY OF LCD MODULE

NO	ITEM	DESCRIPTION
1	High temperature operation	The sample should be allowed to stand at +70°C for 240 hrs
2	Low temperature operation	The sample should be allowed to stand at -20°C for 240 hrs
3	High temperature storage	The sample should be allowed to stand at +80°C for 240 hrs
4	Low temperature storage	The sample should be allowed to stand at -30°C for 240 hrs
5	High temp / humidity test	The sample should be allowed to stand at 60°C , 90% RH 240 hrs
6	Thermal shock (not operated)	The sample should be allowed to stand the following 200 cycles of operation: -25°C for 30 minutes ~ +70°C for 30 minutes
7	ESD (Electrostatic Discharge)	AIR DISCHARGE ± 4KV CONTACT DISCHARGE ± 2KV

NOTE (1) : THE TEST SAMPLES HAVE RECOVERY TIME FOR 2 HOURS AT ROOM TEMPERATURE BEFORE THE FUNCTION CHECK. IN THE STANDARD CONDITIONS , THERE IS NO DISPLAY FUNCTION NG ISSUE CCURRED.

12.5 TESTING CONDITIONS AND INSPECTION CRITERIA

For the final test the testing sample must be stored at room temperature for 24 hours, after the tests listed in table 12.5 , standard specifications for reliability have been executed in order to ensure stability .

NO	ITEM	TEST MODEL	INSPECTION CRITERIA
1	Current consumption	Refer To Specification	The current consumption should conform to the product specification.
2	Contrast	Refer TO Specification	After the tests have been executed, the contrast must be larger than half of its initial value prior to the tests.
3	Appearance	Visual inspection	Defect free

12.6 OPERATION

- 12.6.1 Do not connect or disconnect modules to or from the main system while power is being supplied .
- 12.6.2 Use the module within specified temperature ; lower temperature causes the retardation of blinking speed of the display ; higher temperature makes overall display discolor . When the temperature returns to normality , the display will operate normally .
- 12.6.3 Adjust the LC driving voltage to obtain the optimum contrast .
- 12.6.4 Power On Sequence input signals should not be supplied to LCD module before power supply voltage is applied and reaches the specified value . If above sequence is not followed , CMOS LSIs of LCD modules may be damaged due to latch - up problem .

12.7 NOTICE

- 12.7.1 Use a grounded soldering iron when soldering connector I/O terminals . For soldering or repairing , take precaution against the temperature of the soldering iron and the soldering time to prevent peeling off the through-hole-pad .
- 12.7.2 Do not disassemble . EDT shall not be held responsible if the module is disassembled and upon the reassembly the module failed .
- 12.7.3 Do not charge static electricity , as the circuit of this module contains CMOS LSIs. A workman's body should always be static-protected by use of an ESD STRAP . Working clothes for such personnel should be of static-protected material .
- 12.7.4 Always ground the electrically-powered driver before using it to install the LCD module. While cleaning the work station by vacuum cleaner, do not bring the sucking mouth near the module ; static electricity of the electrically-powered driver or the vacuum cleaner may destroy the module .
- 12.7.5 Don't give external shock.
- 12.7.6 Don't apply excessive force on the surface.
- 12.7.7 Liquid in LCD is hazardous substance. Must not lick and swallow. When the liquid is attach to your, skin, cloth etc. Wash it out thoroughly and immediately.
- 12.7.8 Don't operate it above the absolute maximum rating.
- 12.7.9 Storage in a clean environment, free from dust, active gas, and solvent.
- 12.7.10 Store without any physical load.
- 12.7.11 Rewiring: no more than 3 times .