

Precision Load Switch with Adjustable Current Limit

DESCRIPTION

The ETA6024 is a load switch which provides full protection to systems and loads which may encounter large current conditions. ETA6024 offers a 95mΩ current-limited switch which can operate over an input voltage range of 2.5-5.5V. The current limit can be externally programmed by a precision resistor, ranges from 75mA to 1.7A. Switch control is by a logic input (EN) capable of interfacing directly with low voltage control signals. Current is prevented from flowing when the switch is off and the output voltage is higher than the input voltage. ETA6024 also features thermal shutdown protection which shuts off the switch to prevent damage to the part when a continuous over-current condition causes excessive heating. When the switch current reaches the current limit, the parts operate in a constant-current mode to prohibit excessive currents from causing damage. The ETA6024 will not turn off after a current limit fault, but will rather remain in the constant current mode indefinitely. The n FAULT output asserts low during over-current and reverse-voltage conditions.

ETA6024 is housed in a tiny SOT2x3-6L package

APPLICATION

- USB ports/Hubs
- Hot Swaps
- Cellphones
- Tablet PC
- Set Top Box
- PC motherboard
- Handheld Devices

FEATURES

- Up to 1.5A Max Load current
- Accurate Current-limit threshold: +/-7%
- Programmable Current-limit : 75mA to 1.7A
- Fast Over-Current Response
- Fault Flag Output: n FAULT Pin
- Reversed Current blocking
- Thermal Shutdown, UVLO protection
- Tiny SOT23-6L Package

ORDERING INFORMATION

PART	PACKAGE PIN	TOP MARK
ETA6024S2G	SOT2x3-6	BkYW └── Date Code └── Product Number

TYPICAL APPLICATION

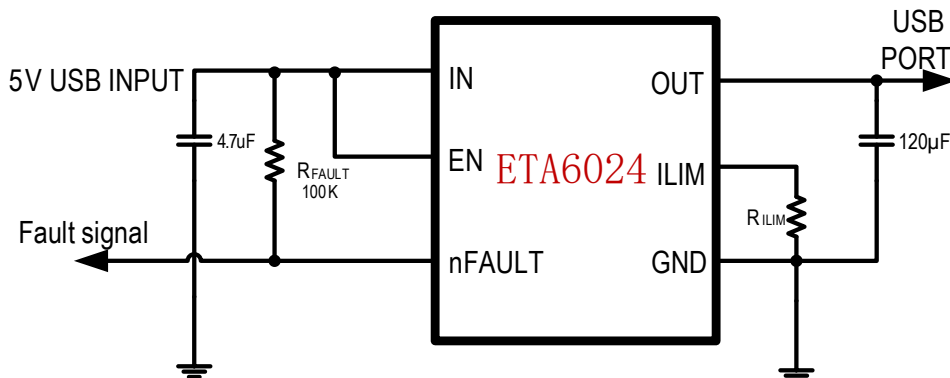

PIN CONFIGURATION

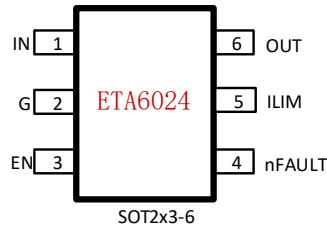

ABSOLUTE MAXIMUM RATINGS

(Note: Exceeding these limits may damage the device. Exposure to absolute maximum rating conditions for long periods may affect device reliability.)

IN to GND.....	-0.3V to 6V
OUT, ILIM, nFAULT, EN to GND.....	-0.3V to $V_{IN}+0.3V$
OUT to GND Current	Internally limited
Maximum Power Dissipation.....	1.0W
Operating Temperature Range	-40°C to 85°C
Storage Temperature Range.....	-55°C to 150°C

ELECTRICAL CHARACTERISTICS

($V_{IN} = 5V$, unless otherwise specified. Typical values are at $T_A = 25^\circ C$.)

PARAMETER	CONDITIONS	MIN	TYP	MAX	UNITS
Input Voltage Range		2.5		5.5	V
Input UVLO	Rising, Hysteresis=25mV		2.35		V
Input Supply Current	$R_{ILIM}=20K$		120		μA
Input Shutdown Current			0.5	1.5	μA
Power Switch On Resistance	$I_{SW} = 500mA$		95		m Ω
	$I_{SW} = 500mA, -40^\circ C \leq T_J \leq 120^\circ C$			145	m Ω
Current limit Threshold	$R_{ILIM}=15K$		1.705		A
	$R_{ILIM}=20K$		1.295		A
	$R_{ILIM}=49.9K$		0.525		A
Response time to Short-circuit			1		μs
Reverse-voltage Threshold	$V_{OUT}-V_{IN}$		150		mV
Reverse Leakage Current	$V_{OUT}=5.5V, V_{in}=0V, V_{EN}=High$		0.5	2	μA
EN Input Logic High threshold	$V_{FAULT}=5.5V$			1	V
EN Input Logic Low threshold		0.66			V
N FAULT Output Low Voltage	$I_{nFAULT} = 1mA$		70	170	mV
N FAULT Output Leakage				1	μA
n FAULT Deglitch Time	De-assertion due to Over-current		9		ms
	De-assertion due to Reverse-Volt---		4.5		
Thermal Shutdown			160		$^\circ C$
Thermal Shutdown In Current Limit			135		$^\circ C$
Thermal Shutdown Hysteresis			15		$^\circ C$

PIN DESCRIPTION

PIN #	NAME	DESCRIPTION
1	OUT	Current limit Output. Bypass with a capacitor that is greater than 120 μ F if used for USB
2	ILIM	Current limit threshold setting pin. Connect a resistor from this pin to GND to set different current limit values
3	N FAULT	Fault flagging pin. Connect a pull up resistor to IN, when in fault conditions, this pin is asserted low
4	EN	Enable pin
5	GND	Ground
6	IN	Power input. Bypass with a 4.7 μ F capacitor to GND

FUNCTION DESCRIPTION

The ETAG024 is a load switch which provides full protection to systems and loads which may encounter large current conditions. ETAG024 offers a 95m Ω current-limited switch which can operate over an input voltage range of 2.5-5.5V. The current limit can be externally programmed by a precision resistor, ranges from 75mA to 1.7A. ETAG024 also features reverse voltage blocking, UVLO, and thermal shutdown to protect IC from overheating. An n FAULT flag output provides a pull-down signal to indicate fault conditions.

CURRENT LIMITING

The current limit ensures that the current through the switch doesn't exceed a maximum value while not limiting at less than a minimum value. The current at which the parts will limit is adjustable through the selection of an external resistor connected to ILIM. Information for selecting the resistor is found in the Application Info section. ETAG024 thermal cycles if an overload condition is present long enough to activate thermal limiting in any of the above cases. The device turns off when the junction temperature exceeds 135 $^{\circ}$ C (t y p) while in current limit. The device remains off until the junction temperature cools 10 $^{\circ}$ C (typ) and then restarts

REVERSE-VOLTAGE BLOCKING

The reverse-voltage protection feature turns off the Power MOSFET whenever the output voltage exceeds the input voltage by 150mV (t y p) for 4-ms (t y p). This prevents

damage to devices on the input side of the ETAG024 by preventing significant current from sinking into the input capacitance. The ETAG024 allow the power MOSFET to turn on once the output voltage goes below the input voltage for the same 4-ms deglitch time. The reverse-voltage condition also asserts the n FAULT output (active-low) after 4-ms. During "OFF" condition, the reverse-voltage blocking function is still in effect, preventing any current floating from OUT to IN even when the device is not in use.

N FAULT FLAG

The FAULT open-drain output is asserted (active low) during an overcurrent, over temperature or reverse-voltage condition. The ETAG024 asserts the FAULT signal until the fault condition is removed and the device resumes normal operation. The n FAULT signal is de-asserted once device power is cycled or the enable is toggled and the device resumes normal operation. The ETAG024 and ETAG024 is designed to eliminate false n FAULT reporting by using an internal delay "deglitch" circuit for overcurrent (9-ms t y p) and reverse-voltage (4.5-ms t y p) conditions without the need for external circuitry. This ensures that n FAULT is not accidentally asserted due to normal operation such as starting into a heavy capacitive load. The deglitching circuitry delays entering and leaving fault conditions. Over temperature conditions are not deglitched and assert the n FAULT signal immediately.

BLOCK DIAGRAM

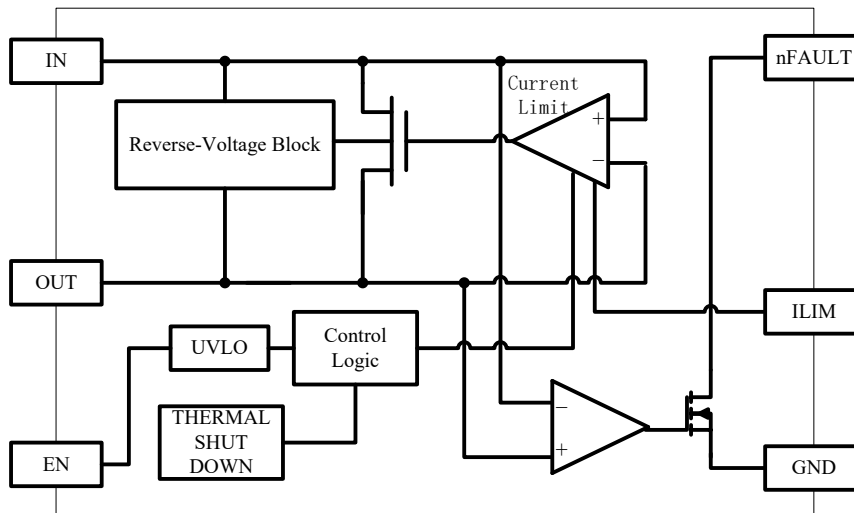

TYPICAL PERFORMANCE CHARACTERISTICS

(VIN = 5V, unless otherwise specified. Typical values are at TA = 25°C.)

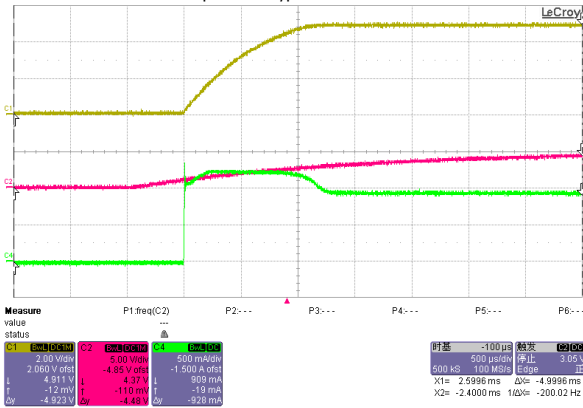

Turn on Delay and Rise time
VIN=5V, RILIM=20K, ROUT=5Ω
CH1: Output Voltage; CH2: Enabled pin Voltage; CH4: Input Current

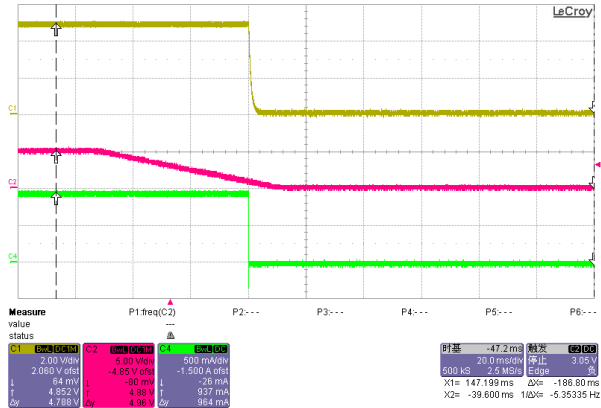

Turn off Delay and Fall Time
VIN=5V, RILIM=20K, ROUT=5Ω
CH1: Output Voltage; CH2: Enabled pin Voltage; CH4: Input Current

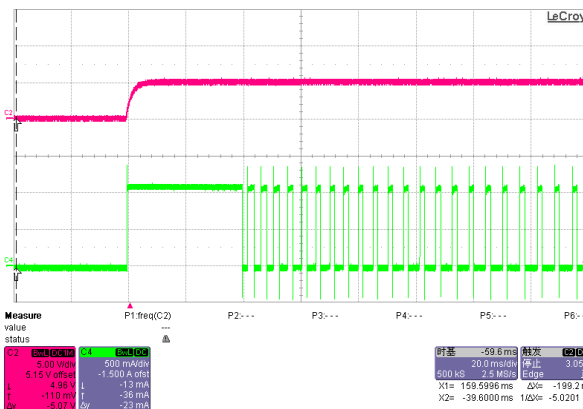

Device Enabled into short-Circuit
VIN=5V, RILIM=20K, ROUT=0Ω
CH2: Enabled pin Voltage; CH4: Input Current

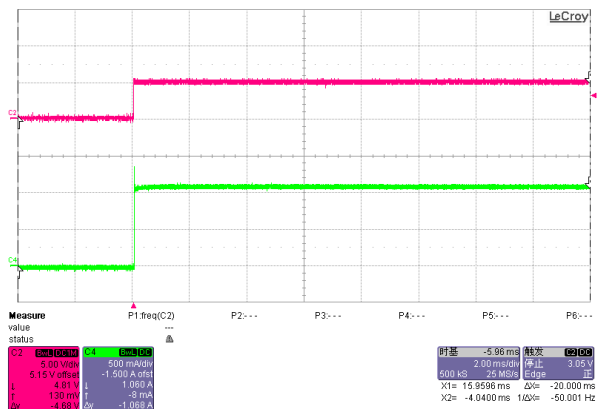

Device Enabled into short-Circuit
VIN=5V, RILIM=20K, ROUT=0Ω
CH2: Enabled pin Voltage; CH4: Input Current

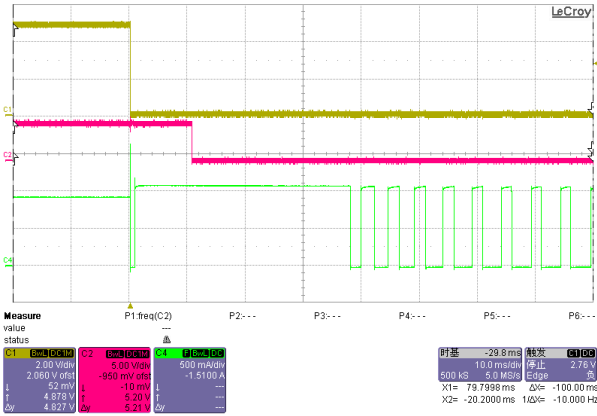

Full Load to Short-Circuit
 VIN=5V, RILIM=20K
 CH1: Output Voltage; CH2: n Fault pin Voltage; CH4: Input Current

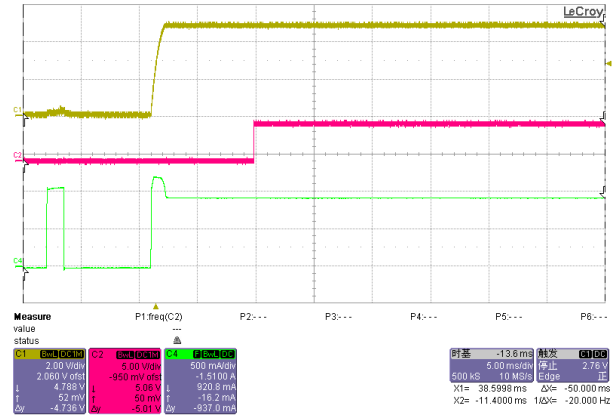

Short-Circuit to Full load
 VIN=5V, RILIM=20K
 CH1: Output Voltage; CH2: n Fault pin Voltage; CH4: Input Current

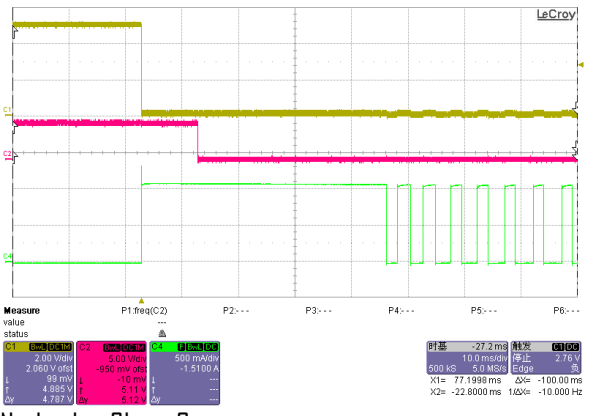

No-load to Short-Circuit
 VIN=5V, RILIM=20K
 CH1: Output Voltage; CH2: n FAULT pin Voltage;
 CH4: Input Current

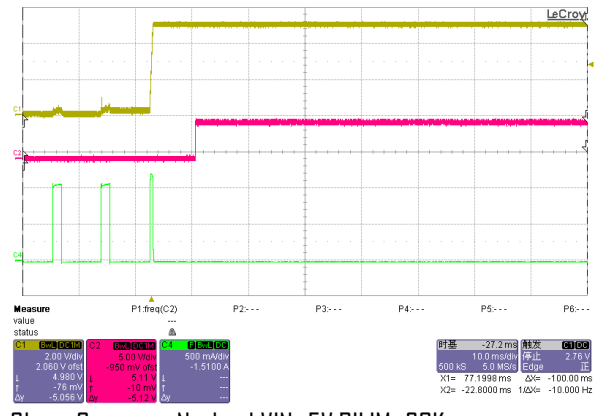

Short-Circuit to No-load VIN=5V, RILIM=20K
 CH1: Output Voltage;
 CH2: n FAULT pin Voltage; CH4: Input Current

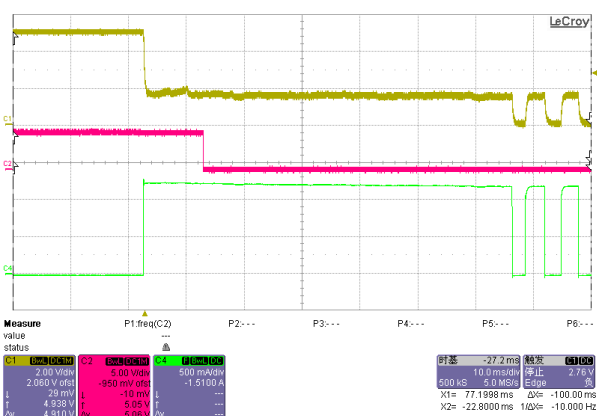

No-load to 1 Ohm-load
 VIN=5V, RILIM=20K
 CH1: Output Voltage; CH2: n FAULT pin Voltage
 CH4: Input Current

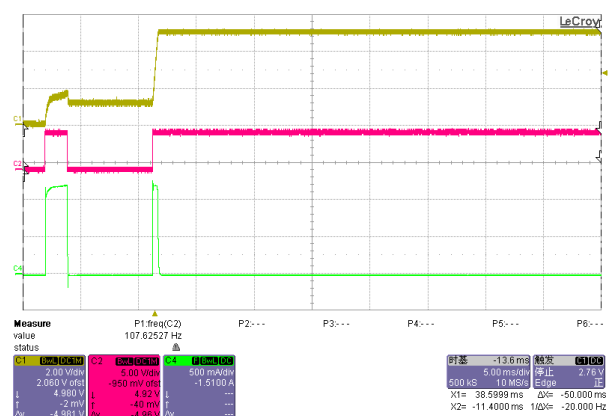

1 Ohm-load to No-load
 VIN=5V, RILIM=20K
 CH1: Output Voltage; CH2: n FAULT pin Voltage
 CH4: Input Current

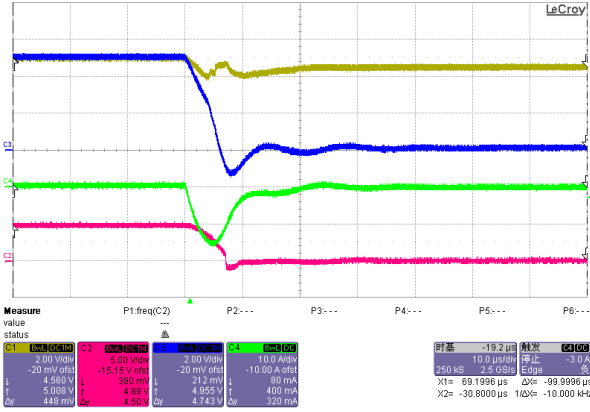

Input Voltage from 5V into 0V
 VOUT=5V, RILIM=20K, ROUT=10Ω
 CH1: Output Voltage; CH2: n FAULT pin Voltage
 CH3: Input Voltage; CH4: Input Current

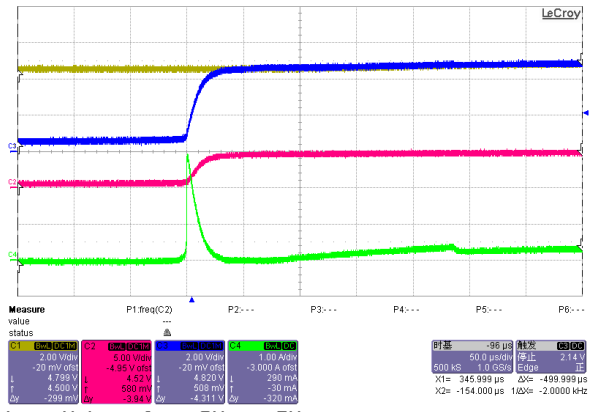

Input Voltage from 0V into 5V
 VOUT=5V, RILIM=20K, ROUT=10Ω
 CH1: Output Voltage; CH2: n FAULT pin Voltage
 CH3: Input Voltage; CH4: Input Current

Switch current VS Drain-Source Voltage

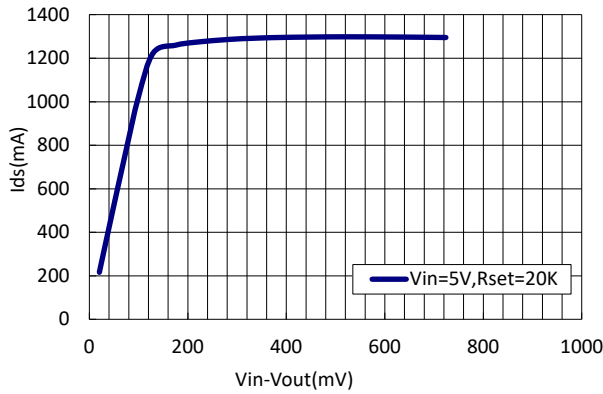

Switch current VS Drain-Source Voltage

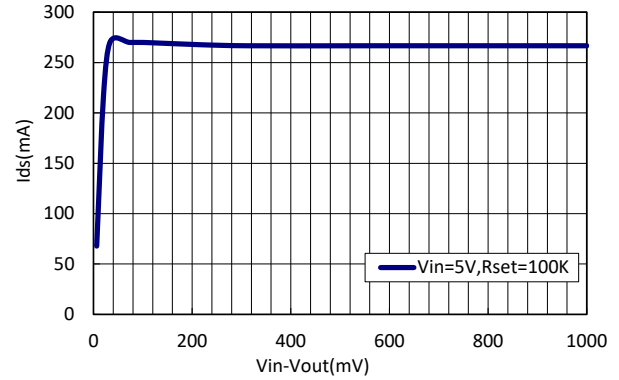

Switch current VS Drain-Source Voltage

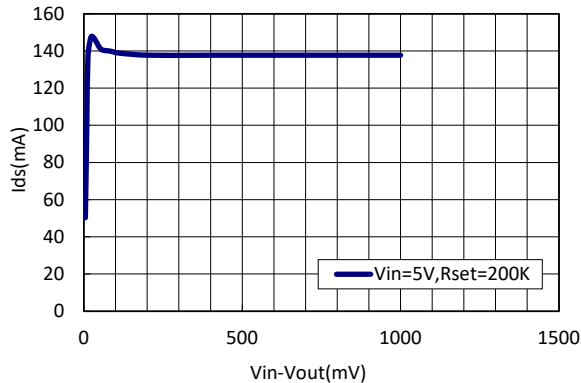

APPLICATION INFORMATION

INPUT OUTPUT CAPACITANCE

Input and output capacitance improves the performance of the device; the actual capacitance should be optimized for the particular application. For all applications, a 4.7 μ F or greater ceramic bypass capacitor between IN and GND is recommended as close to the device as possible for local noise de-coupling. This precaution reduces ringing on the input due to power-supply transients. Additional input capacitance may be needed on the input to reduce voltage overshoot from exceeding the absolute maximum voltage of the device during heavy transient conditions. This is especially important during bench testing when long, inductive cables are used to connect the evaluation board to the bench power-supply. Placing a high-value electrolytic capacitor on the output pin is recommended when large transient currents are expected on the output.

SETTING THE CURRENT LIMIT THRESHOLD

R _{ILIM} (K Ω)	Typical Current Limit (mA)
200	138
180	152
151	179
100	266
82	324
68	389
51	520
43	612
30	873
20	1295
15.1	1705

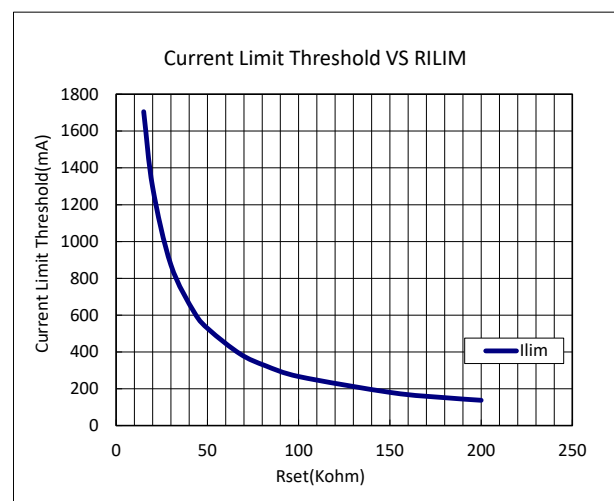

POWER DISSIPATION

During normal operation as a switch, the power dissipated in the part will depend upon the level at which the current limit is set. The maximum allowed setting for the current limit is 1A and this will result in a power dissipation of,

$$P = (ILIM)^2 \times RDS = (1)^2 \times 0.10 = 100mW$$

If the part goes into current limit the maximum power dissipation will occur when the output is shorted to ground. This is more power than the package can dissipate, but the thermal shutdown of the part will activate to protect the part from damage due to excessive heating. A short on the output will cause the part to operate in a constant current state dissipating a worst case power of,

$$P(max) = VIN(max) \times ILIM(max) = 5.5 \times 1 = 5.5W$$

This large amount of power will activate the thermal shutdown and the part will cycle in and out of thermal shutdown so long as the QN pin is active and the short is present.

PACKAGE OUTLINE

SOT23-6

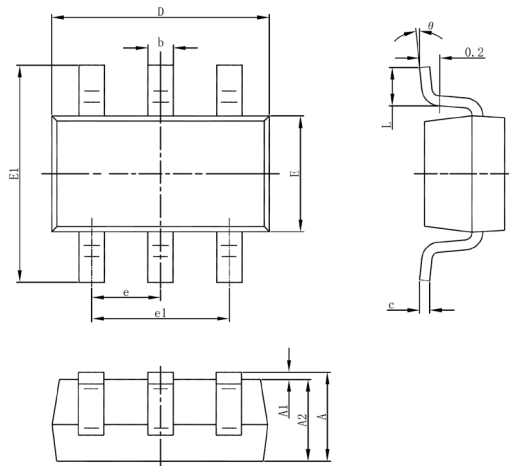

Symbol	Dimensions In Millimeters		Dimensions In Inches	
	Min	Max	Min	Max
A	1.050	1.250	0.041	0.049
A1	0.000	0.100	0.000	0.004
A2	1.050	1.150	0.041	0.045
b	0.300	0.500	0.012	0.020
c	0.100	0.200	0.004	0.008
D	2.820	3.020	0.111	0.119
E	1.500	1.700	0.059	0.067
E1	2.650	2.950	0.104	0.116
e	0.950(BSC)		0.037(BSC)	
e1	1.800	2.000	0.071	0.079
L	0.300	0.600	0.012	0.024
θ	0°	8°	0°	8°