

## 18V, 2A, High Efficiency Synchronous Step-Down Converter in SOT23-6

### DESCRIPTION

ETA8222 is a wide input range, high-efficiency and high frequency DC-to-DC step-down switching regulator, capable of delivering up to 2A of output current. It adopts an Adaptive COT control scheme that enables very fast transient response and provides a very smooth transition when the output varies from light load to heavy load. During light load, ETA8222 goes into a PFM mode that saves switching loss achieving high efficiency. The adaptive COT control also maintains a constant switching frequency across line and load.

ETA8222 is available in SOT23-6 package.

### FEATURES

- ◆ Wide Input Range: 4.5V-18V
- ◆ Adaptive COT Control
- ◆ Ultra-fast load transient response
- ◆ High Efficiency PFM mode at light load
- ◆ High Efficiency Synchronous operation
- ◆ No load Iq 210uA
- ◆ Low Rdson Internal power FETs
- ◆ Capable of Delivering 2A
- ◆ No External Compensation Needed
- ◆ Thermal Shutdown and UVLO
- ◆ Available in SOT23-6 Package

### APPLICATIONS

- ◆ LCD TV
- ◆ Set Top Box
- ◆ xDSL Modem

### TYPICAL APPLICATION

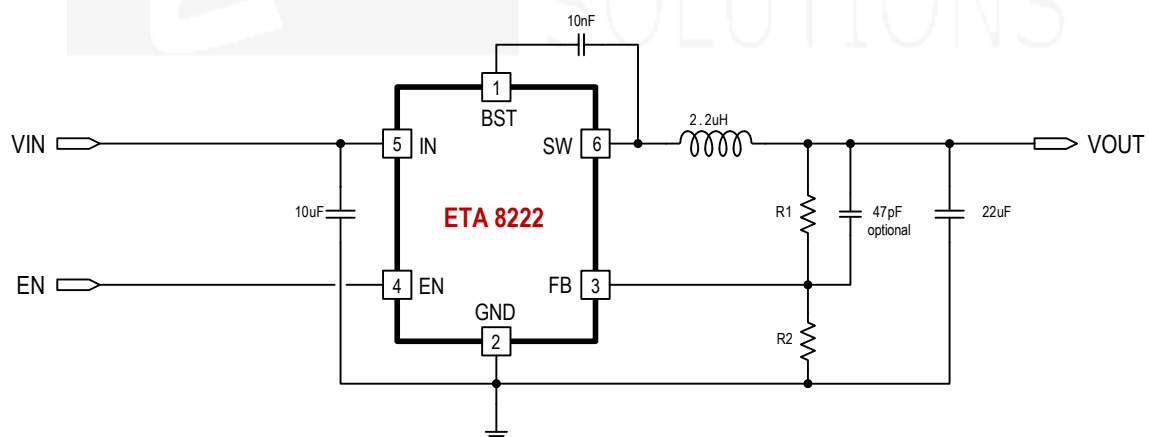

$$V_{out} = \frac{R1+R2}{R2} \times 0.6(V)$$

### ORDERING

PART No.	PACKAGE	TOP MARK	Pcs/Reel
ETA8222S2G	SOT23-6	JVYW	3000

### INFORMATION

## PIN CONFIGURATION

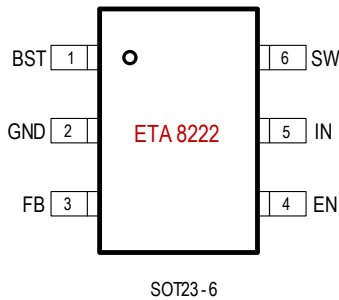

## ABSOLUTE MAXIMUM RATINGS

(Note: Exceeding these limits may damage the device. Exposure to absolute maximum rating conditions for long periods may affect device reliability.)

IN, EN Voltage .....	-0.3V to 19V
SW Voltage ....	-0.3V (-5V for <10nS) to 19V (23V for <10nS)
BST Voltage .....	-0.3V to SW+6V
FB Voltage .....	-0.3V to 6V
Junction Temperature.....	150°C
Operating Ambient Temperature Range .....	-40°C to 85°C
Operating Junction Temperature Range .....	-40°C to 125°C
Storage Temperature Range .....	-55°C to 150°C
Thermal Resistance	$\theta_{JA}$ $\theta_{JC}$
SOT23-6.....	180.....90..... °C/W
Lead Temperature (Soldering 10sec) .....	260°C
ESD HBM (Human Body Mode) .....	2KV
ESD MM (Machine Mode) .....	200V

## ELECTRICAL CHARACTERISTICS

( $V_{IN} = 12V$ ,  $V_{OUT} = 3.3V$ , unless otherwise specified. Typical values are at  $T_A = 25^\circ C$ .)

PARAMETER	CONDITIONS	MIN	TYP	MAX	UNIT
Input Voltage Range		4.5		18	V
Input UVLO	Rising		4.05		V
Input OVP	Rising, Hysteresis=0.85V		19.5		V
Input Supply Current	no switching		210		$\mu A$
Input Shutdown Current			7	14	$\mu A$
FB Voltage		0.591	0.6	0.609	V
FB Input Current			0	0.05	$\mu A$
Switching Frequency			1		MHz
Maximum Duty Cycle			99		%
Short Circuit Hiccup Time	On Time		2		mS
	Off Time		6		mS
FB Hiccup Threshold			0.2		V
High Side Switch On Resistance			160		m $\Omega$
Low Side Switch On Resistance			95		m $\Omega$
High Side Current Limit			4.2		A
SW Leakage Current	$I_{N}=SW=12V$			10	$\mu A$
EN Rising Threshold	Rising,		1.5		V
EN Falling Threshold	Falling		1.3		V
EN Input Current	$V_{EN}=2V$		1		$\mu A$
Thermal Shutdown	Rising, Hysteresis =36°C		150		°C

## PIN DESCRIPTION

PIN #	NAME	DESCRIPTION
1	BST	Bootstrap pin. Connect a 10nF capacitor from this pin to SW
2	GND	Ground
3	FB	Feedback Input. Connect an external resistor divider from the output to FB and GND to set $V_{OUT}$
4	EN	Enable pin for the IC. Drive this pin high to enable the part, low or floating to disable.
5	IN	Supply Voltage. Bypass with a 10 $\mu$ F ceramic capacitor to GND
6	SW	Inductor Connection. Connect an inductor Between SW and the regulator output.

## TYPICAL CHARACTERISTICS

(Typical values are with  $C_{ff}=47pF$ , at  $T_A = 25^\circ C$  unless otherwise specified.)

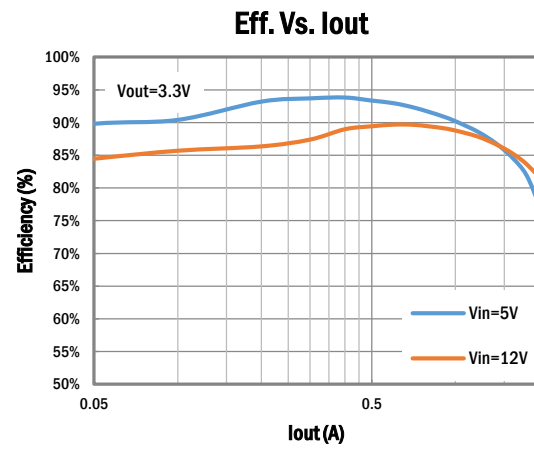
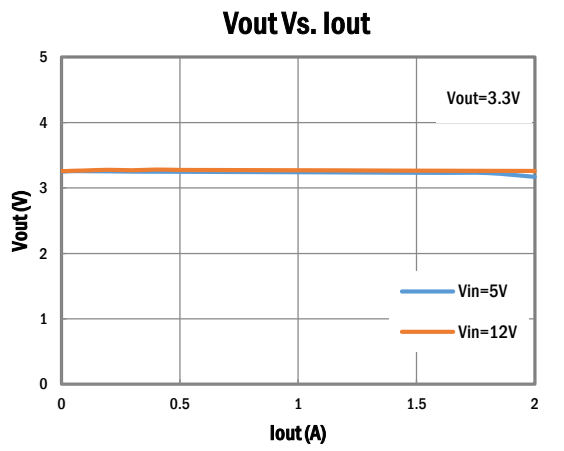
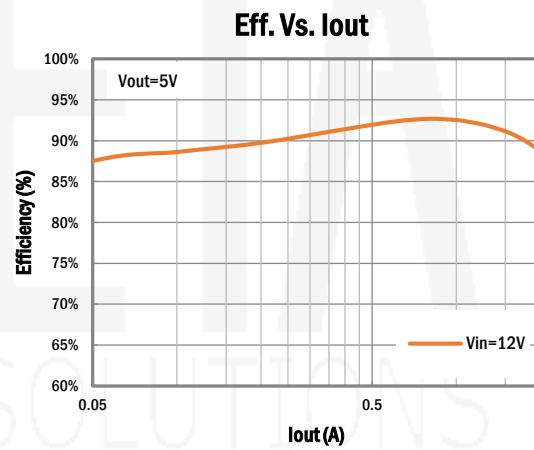
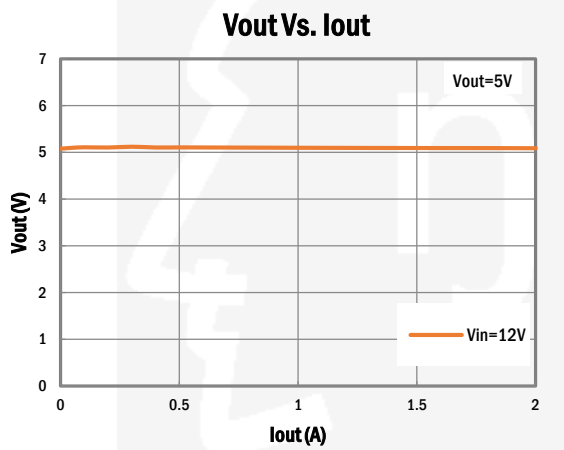

## TYPICAL CHARACTERISTICS (cont')

(Typical values are with  $C_{ff}=47pF$ , at  $T_A = 25^\circ C$  unless otherwise specified.)

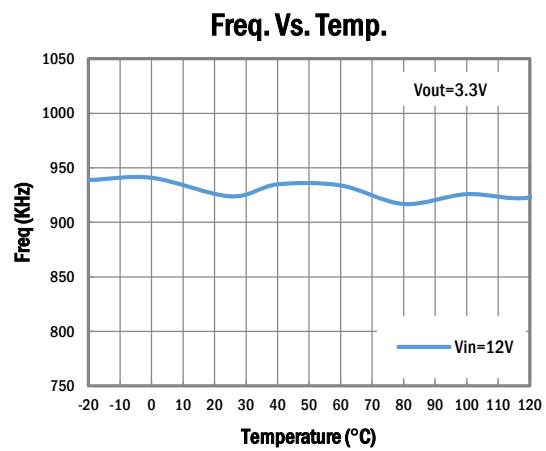
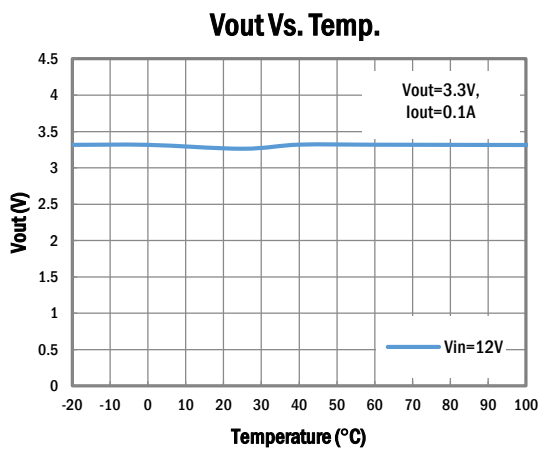
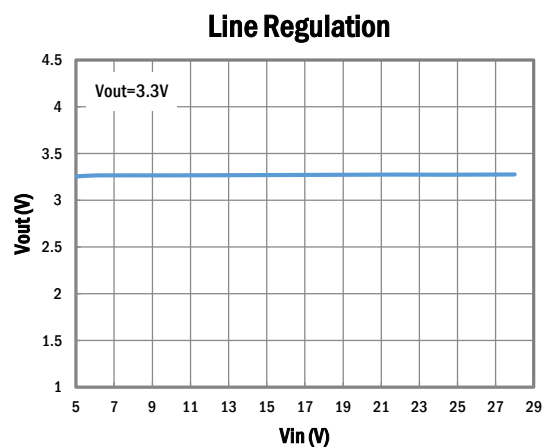
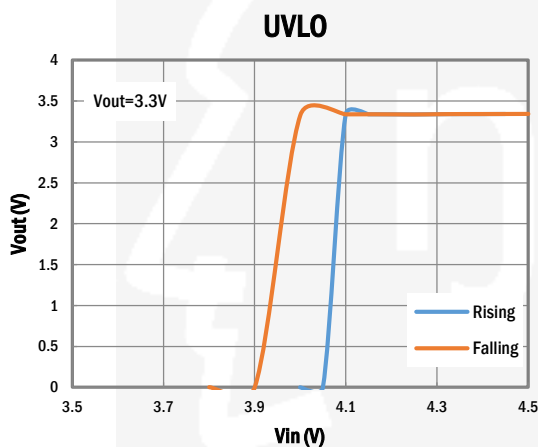
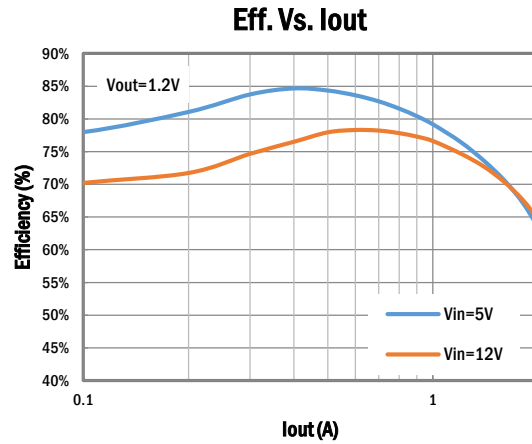
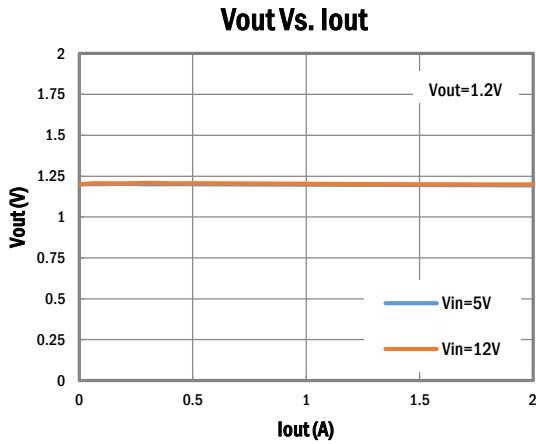

## TYPICAL CHARACTERISTICS (cont')

(Typical values are with  $C_{ff}=47pF$ , at  $T_A = 25^\circ C$  unless otherwise specified.)

Turn On Waveform

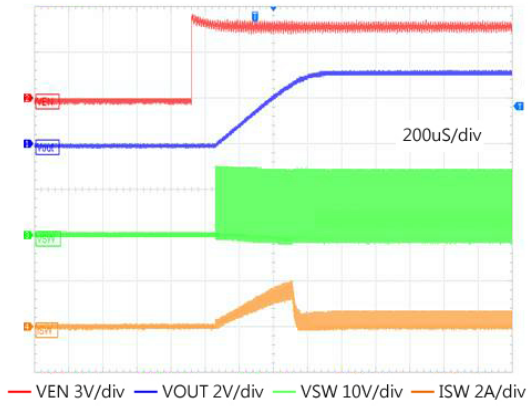

Turn Off Waveform

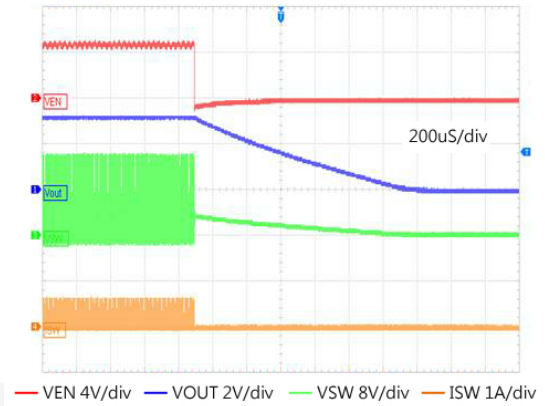

3.3V 0.1-2A Transient Response

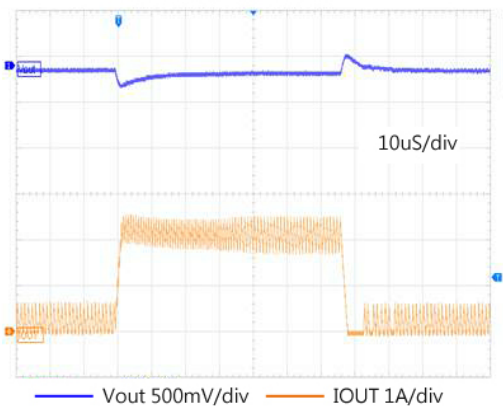

3.3V 0-1A Transient Response

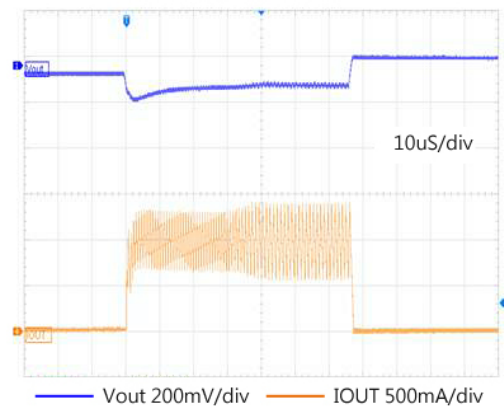

Short Circuit Protection

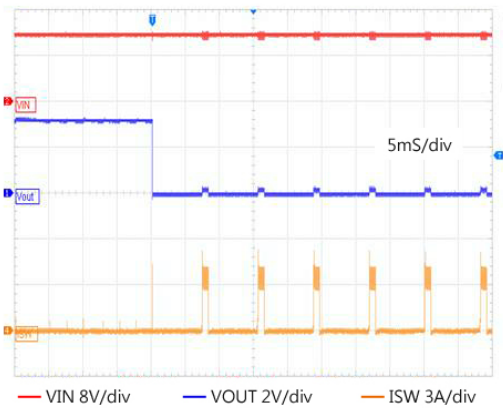

Recovery

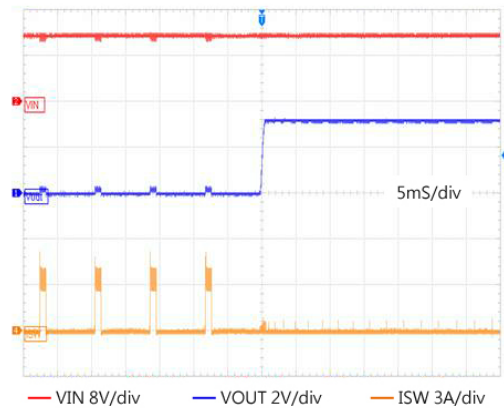

## FUNCTIONAL BLOCK DIAGRAM

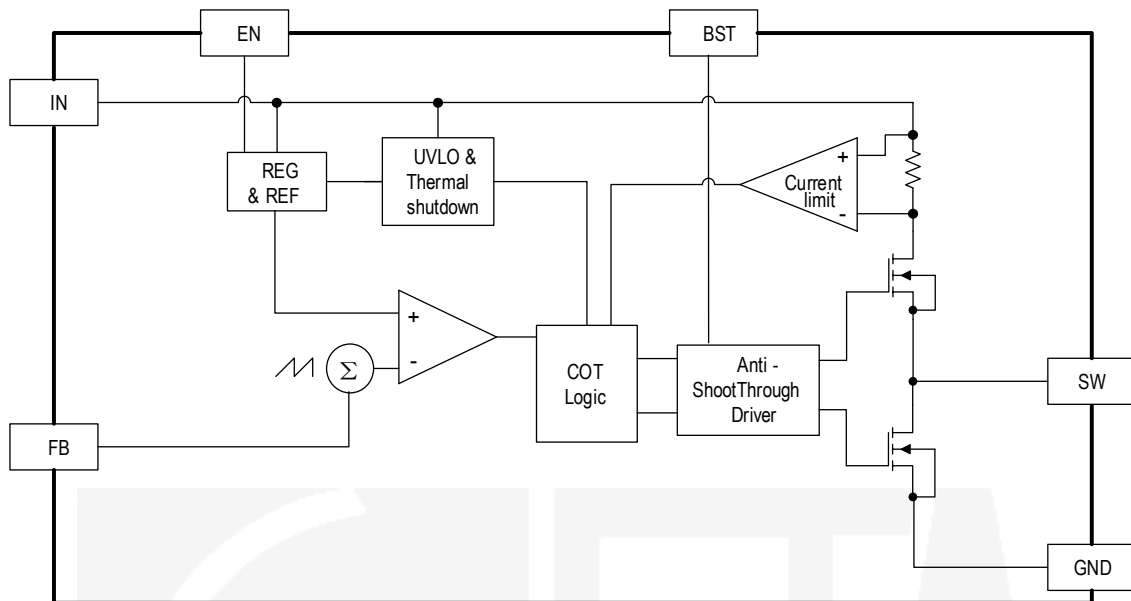

## FUNCTIONAL DESCRIPTION

The ETA8222 is a synchronous buck regulator ICs that integrates the adaptive COT control, top and bottom switches on the same die to minimize the switching transition loss and conduction loss.

ETA8222 is a wide input range, high-efficiency and high frequency DC-to-DC step-down switching regulator, capable of delivering up to 2A of output current. It adopts an Adaptive COT control scheme that enables very fast transient response and provides a very smooth transition when the output varies from light load to heavy load. It compares the sum of the FB voltage and a ripple voltage that mimics the voltage due to the output ESR and capacitance. The constant-on-time timer varies with line to achieve relative constant switching frequency across line.

### *Light Load Operation*

Traditionally, a fixed constant frequency PWM DC-DC regulator always switches even when the output load is small. When energy is shuffling back and forth through the power MOSFET, power is lost due to the finite  $R_{ds(on)}$  of the MOSFET and parasitic capacitances. At light load, this loss is prominent and efficiency is therefore very low. ETA8222 goes into a power save mode during light load, thereby extending the range of high efficiency operation.

### *Enable*

EN is a digital control pin that turns the ETA8222 on and off. Drive EN High to turn on the regulator, drive it Low to turn it off. An internal  $1M\Omega$  resistor from EN pin to GND allows EN to float to shut down the chip. Connecting the EN pin through a pull up resistor or shorted EN to IN will automatically turn on the chip whenever plug in IN.

### *Over Current Protection and Hiccup*

ETA8222 has a cycle-by-cycle over current limit for when the inductor current peak value is over the set current limit threshold. When the output voltage drop until FB falls below UV threshold (0.2V), the ETA8222 will enter hiccup mode. It will turn off the chip immediately for 6mS. After that, it will try to re-starts as

normal for 2mS. After 2mS, if FB is still below UV threshold, then the chip enters hiccup mode again. If FB is higher than UV threshold, it will enter the normal mode.

**Over-Temperature Protection**

Thermal protection disables the output when the junction temperature rises to approximately 150°C, allowing the device to cool down. When the junction temperature cools to approximately 110°C, the output circuitry is again enabled. Depending on power dissipation, thermal resistance, and ambient temperature, the thermal protection circuit may cycle on and off. This cycling limits regulator dissipation, protecting the device from damage as a result of overheating.

**APPLICATION INFORMATION**

**External Output Voltage Setting**

In external Output Voltage Setting Version selected, the ETA8222 regulator is programmed using an external resistor divider. The output voltage is calculated using below equation.

$$V_{OUT} = V_{REF} \times \left(1 + \frac{R_1}{R_2}\right)$$

Where: VREF = 0.6V typically (the internal reference voltage)

Resistors R2 has to be between 1kOhm to 70kOhm and thus R1 is calculated by following equation.

$$R_1 = \left(\frac{V_{OUT}}{V_{REF}} - 1\right) \times R_2$$

**PCB LAYOUT GUIDE**

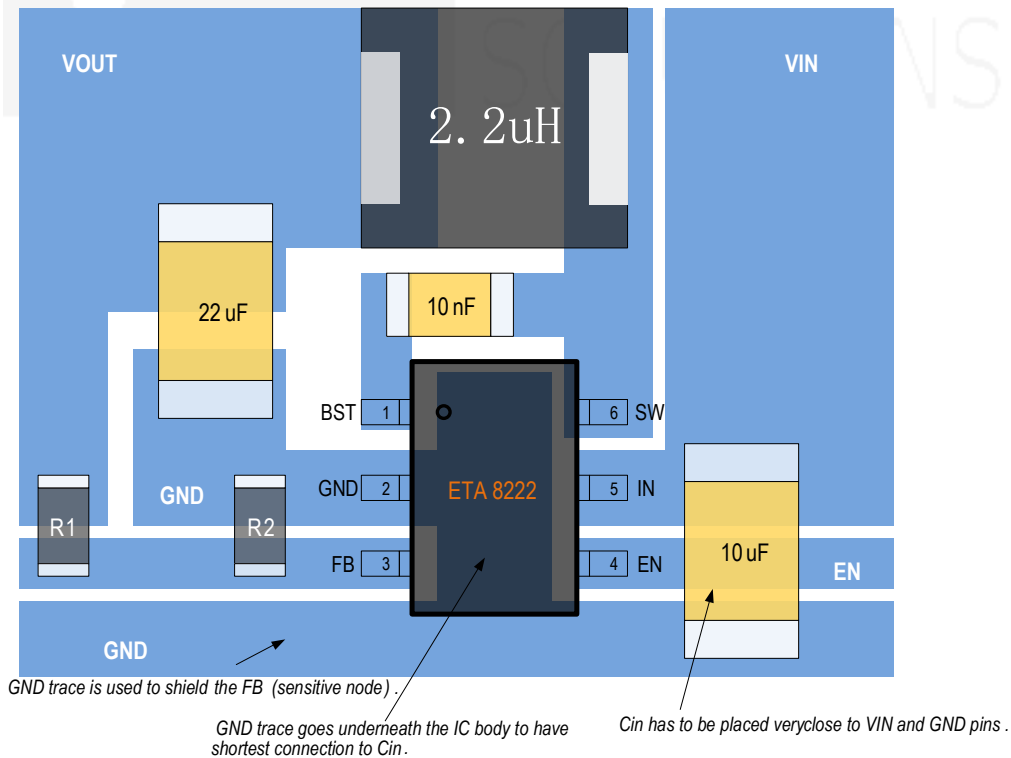

## PACKAGE OUTLINE

Package: SOT23-6

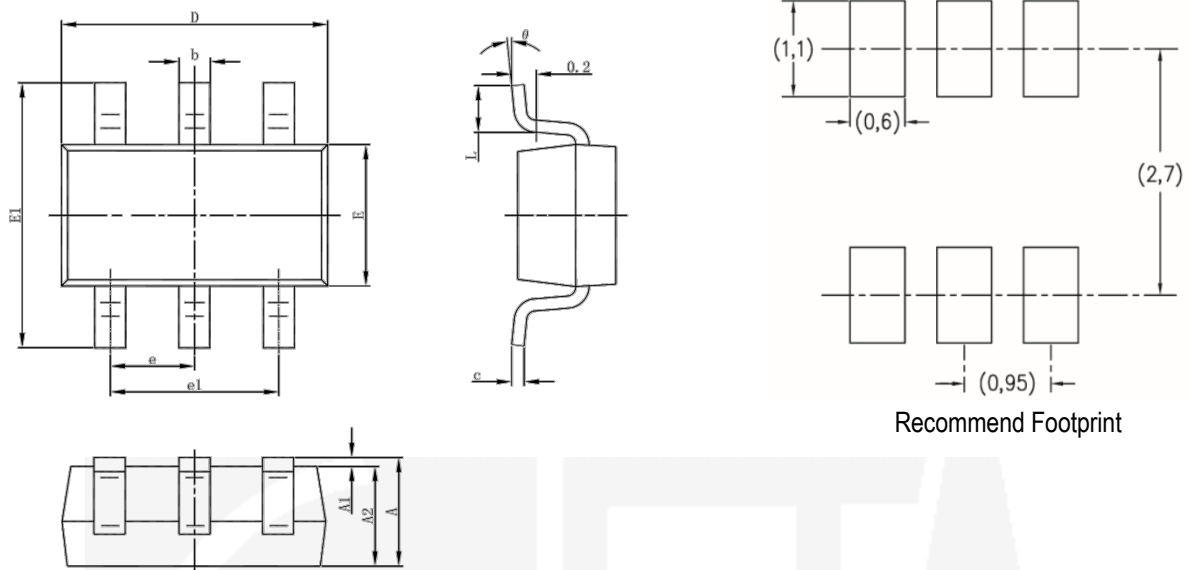

Recommend Footprint

Symbol	Dimensions In Millimeters		Dimensions In Inches	
	Min	Max	Min	Max
A	1.050	1.250	0.041	0.049
A1	0.000	0.100	0.000	0.004
A2	1.050	1.150	0.041	0.045
b	0.300	0.500	0.012	0.020
c	0.100	0.200	0.004	0.008
D	2.820	3.020	0.111	0.119
E	1.500	1.700	0.059	0.067
E1	2.650	2.950	0.104	0.116
e	0.950(BSC)		0.037(BSC)	
e1	1.800	2.000	0.071	0.079
L	0.300	0.600	0.012	0.024
θ	0°	8°	0°	8°