

## 20V Standoff, 2.4A Charger and 2.4A Boost for Power Bank All-in-One Solution

### DESCRIPTION

ETA9882 is a switching Li-Ion battery charger capable of delivering up to 2.4A of charging current to the battery and also capable of delivering up to 2.4A in boost operation. ETA9882 includes a power path from IN to OUT, a buck charger, a 5V boost converter, and a charge status indication. The buck charger guarantees a 93.5% average efficiency at 2.4A charge current and the boost converter achieves 92% efficiency at 2.4A output when battery voltage is as low as 3.3V. It greatly increases the effective battery capacity for a battery powered system, such as power bank. With all these features, ETA9882 is an ideal all-in-one solution for Li<sup>+</sup> battery charging, discharging applications.

ETA9882 is available in ESSOP10 package.

### FEATURES

- ◆ 20V Input Standoff Voltage
- ◆ Bi-Directional Power Conversion with Single Inductor
- ◆ Power Path from IN to OUT
- ◆ ENBST and ENCHRG Function
- ◆ 4.2V/4.35V Optional Battery CV voltage
- ◆ Switching Charger
- ◆ 5V Synchronous Boost
- ◆ Up to 96% Efficiency
- ◆ No External Sense Resistor
- ◆ NTC Monitor
- ◆ Charge Status Indication
- ◆ Charge Current Programmable
- ◆ RoHS Compliant

### APPLICATIONS

- ◆ Power Bank
- ◆ Li<sup>+</sup> Battery Powered System

### TYPICAL APPLICATION

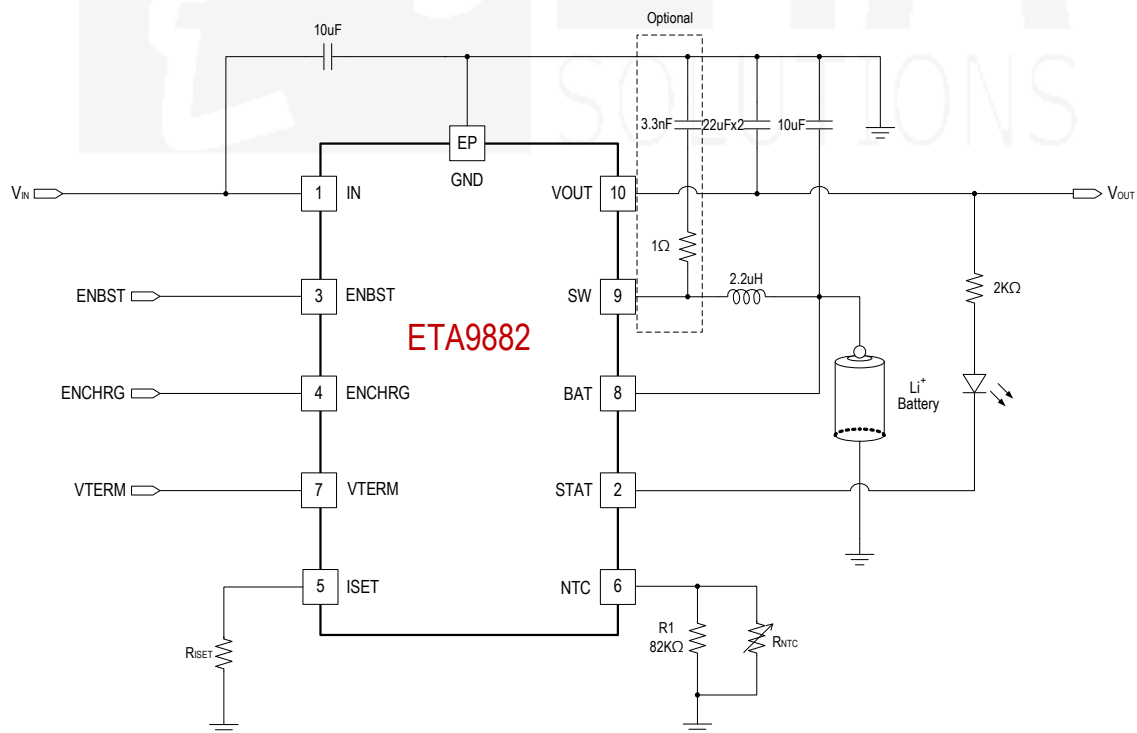

## ORDERING INFORMATION

PART No.	PACKAGE	TOP MARK	Pcs/Reel
ETA9882E10	ESSOP10	ETA9882 YWW2L	4000

## PIN CONFIGURATION

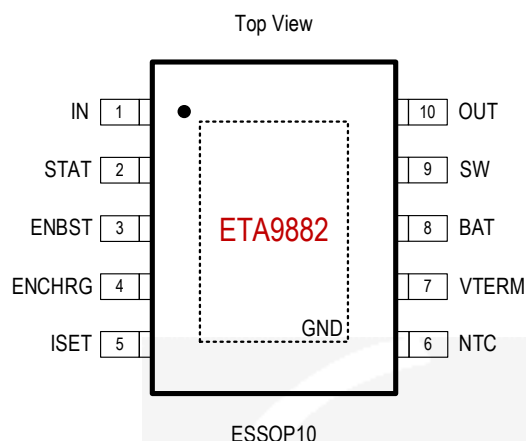

## ABSOLUTE MAXIMUM RATINGS

(Note: Exceeding these limits may damage the device. Exposure to absolute maximum rating conditions for long periods may affect device reliability.)

IN Voltage	.....	-0.3V to 20V
OUT Voltage	.....	-0.3V to 6V
All Other Pin Voltage	.....	$V_{OUT} - 0.3V$ to $V_{OUT} + 0.3V$
SW, IN, OUT to ground current	.....	Internally limited
Operating Temperature Range	.....	-40°C to 85°C
Storage Temperature Range	.....	-55°C to 150°C
Thermal Resistance	$\theta_{JC}$ $\theta_{JA}$	
ESSOP10	..... 10..... 40.....	°C/W
Lead Temperature (Soldering, 10sec)	.....	260°C

## ELECTRICAL CHARACTERISTICS

( $V_{IN} = 5V$ ,  $V_{BAT} = 3.8V$ ,  $L = 2.2\mu H$  unless otherwise specified. Typical values are at  $T_A = 25^\circ C$ .)

PARAMETER	CONDITIONS	MIN	TYP	MAX	UNITS
<b>BUCK MODE</b>					
Input Standoff Voltage		20			V
Input Voltage Range		4.5		6	V
Input UVLO Voltage	Rising, Hys=500mV		4.5		V
IN to OUT $R_{dson}$			95		m $\Omega$
IN to OUT Input Current Limit			3.5		A
IN to OUT Hiccup Threshold Voltage	Falling, $V_{IN} - V_{OUT} > 500mV$ Rising, Hys=100mV		500		mV
Hiccup On Time			7		mS
Hiccup Off Time			350		mS
Input OVP Voltage	Hys=500mV		6.1		V
IN Operating Current as Buck	Switcher Enable, Switching		5		mA
	Switcher Enable, No Switching		500		$\mu A$
<b>BATTERY CHARGER</b>					
Battery CV Voltage	$V_{TERM} = LOW$	4.16	4.2	4.24	V
	$V_{TERM} = HIGH$	4.31	4.35	4.39	V
Charger Restart Threshold			-170		mV
Battery Pre-Condition Voltage	$V_{BAT}$ Rising, Hys=200mV		3		V

PARAMETER	CONDITIONS	MIN	TYP	MAX	UNITS
Pre-Condition Charge Current			230		mA
Fast Charge Current	R <sub>ISET</sub> =45K		2.4		A
Charge Termination Current			10		%ICC
Charge Termination Blanking Time			12		S
<b>BOOST MODE</b>					
BAT OK Threshold	Rising within 50ms		3.2		V
	Falling		2.9		V
	Unlock Voltage		3.5		V
Output Voltage Range	I <sub>OUT</sub> =0A	4.95	5.05	5.15	V
Output Cord Compensation	I <sub>OUT</sub> =2.4A		150		mV
Quiescent Current at BAT Pin	Boost On		500		μA
Shutdown Supply Current at BAT Pin	ENBST=0		2		μA
Switching Frequency	V <sub>BAT</sub> <4.4V		0.5		MHz
Output Current Limit	V <sub>BAT</sub> =3.8V	2.4	2.8	3.2	A
Maximum Duty Cycle			95		%
High Side Pmos R <sub>dson</sub>	I <sub>SW</sub> =500mA		36		mΩ
Low Side Nmos R <sub>dson</sub>	I <sub>SW</sub> =500mA		26		mΩ
Short Circuit Hiccup Current			3		A
Over Current Detect Time			100		mS
From Short to Reboot Time			1		S
<b>STAT</b>					
STAT Output Low Voltage	I <sub>STAT</sub> =10mA			0.2	V
<b>LOGIC INPUT: ENBST, ENCHRG, VTERM</b>					
Logic Input High		1.2			V
Logic Input Low				0.4	V
<b>NTC IN CHARGING MODE</b>					
Cold Threshold	Disable Charging, Rising		1.32		V
Hot Threshold	Disable Charging, Falling		0.56		V
<b>NTC IN BOOST MODE</b>					
Cold Threshold	Disable Boost, Rising		1.52		V
Hot Threshold	Disable Boost, Falling		0.38		V
<b>THERMAL PROTECTION</b>					
Charging Thermal Regulation Threshold			110		°C
Thermal Shutdown	Rising, Hys=30°C		160		°C

## PIN DESCRIPTION

PIN #	NAME	DESCRIPTION
1	IN	DC input pin. Bypass with a 10uF capacitor from this pin to GND
2	STAT	Open-drain output, drive a LED to indicate the charge status.
3	ENBST	Enable pin for the boost. Drive this pin high to enable, low or floating to disable.
4	ENCHRG	Enable pin for the charger. Drive this pin high or floating to enable, low to disable.
5	ISET	Charge current programmable pin. The charge current is programmed by connecting a 1% resistor ( $R_{ISET}$ ) from ISET pin to GND pin. The charge current can be calculated by using the following formula: $I_{CHRG}(A) = \frac{108000}{R_{ISET}(K\Omega)}$
6	NTC	Battery temperature monitoring pin. It sets the operating temperature range for the charging or boost process. Enable NTC by setting $R1=82K$ , $R_{NTC}=100K$ . Tie NTC pin to GND to disable NTC.
7	VTERM	Termination voltage selection pin. Drive this pin low, battery CV voltage is 4.2V; drive this pin high, battery CV voltage is 4.35V.
8	BAT	Battery voltage sense pin. Connect a separate sensing wire to the battery positive terminal to avoid voltage drop and achieve accurate battery CV charging. Bypass with a 10uF capacitor from this pin to GND as close as possible.
9	SW	Switching pin. Connect an inductor between this pin and BAT pin.
10	OUT	USB 5.05V output during boost and charging input pin during charging. This is a power pin, bypass with 2*22uF capacitors from this pin to GND as close as possible.
EP	GND	The substrate of the chip, connected to GND, and large area of ground trace for good thermal dissipation.

## TYPICAL CHARACTERISTICS

(Typical values are at  $T_A = 25^\circ C$  unless otherwise specified.)

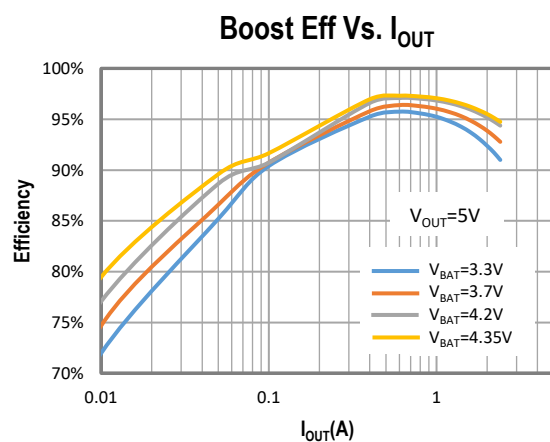
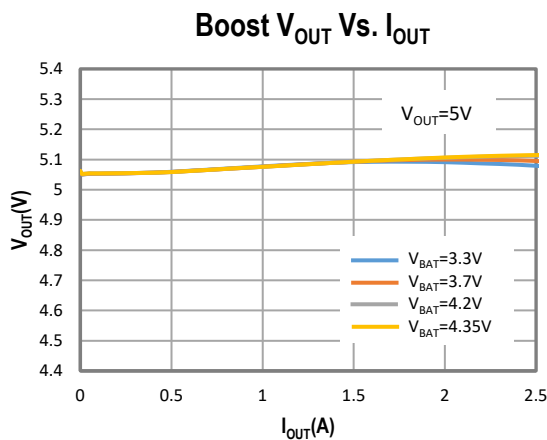

## TYPICAL CHARACTERISTICS Cont'd

(Typical values are at  $T_A = 25^\circ\text{C}$  unless otherwise specified.)

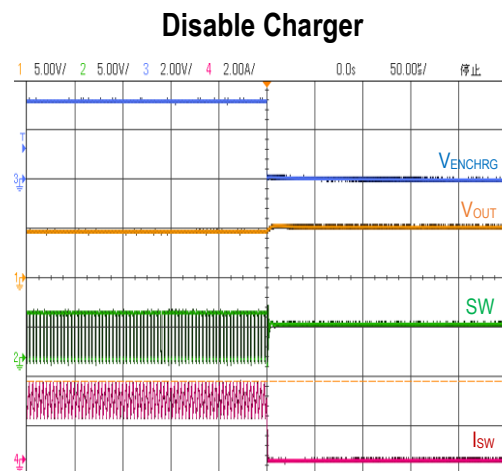
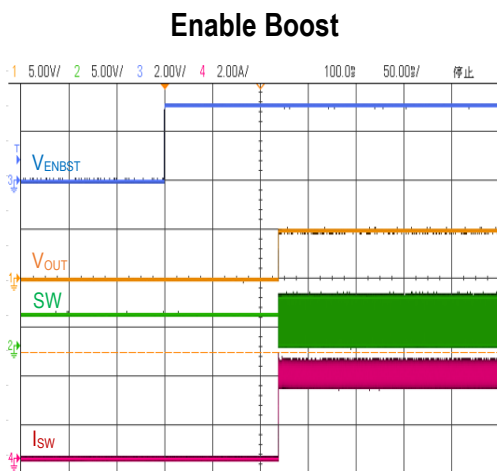
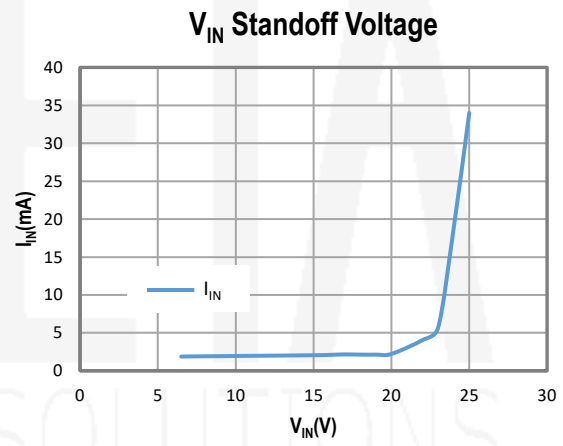
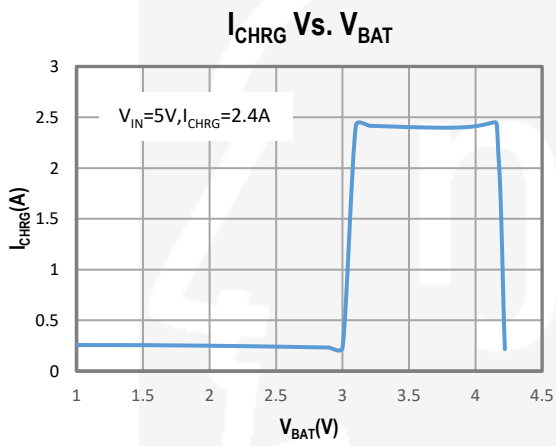
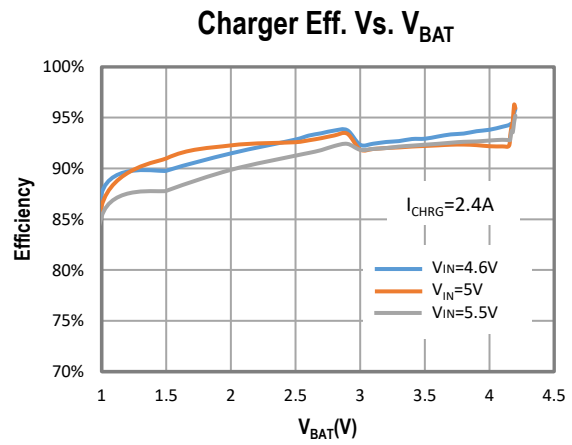
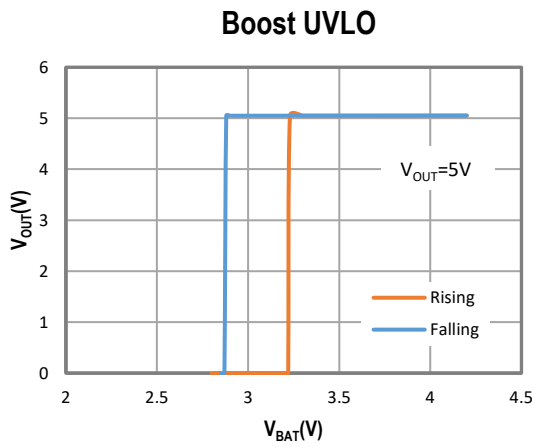

## APPLICATION INFORMATION

ETA9882 is a switching Li-Ion battery charger, which is capable of delivering 2.4A of charging current and can deliver up to 2.4A output current in boost operation.

### Normal Charge Cycle

The ETA9882 initiates a charge cycle once the voltage at the IN pin rises above the UVLO threshold level. A 1% precision resistor needs to be connected from the ISET pin to ground. If the voltage at the BAT pin is less than 3V, the charger enters pre-condition charge mode. In this mode, the charge current is reduced to 230mA until the battery voltage is raised to a safe level for full current charging.

The charger switches to constant-current mode as the BAT pin voltage rises above 3V, and the charge current is programmed by  $R_{ISET}$ . When the final float voltage (4.2V/4.35V) is reached, the ETA9882 enters constant-voltage mode and the charge current begins to decrease until it drops to 1/10 of the programmable value and ends the charge cycle.

### Charge Status Indicator

The ETA9882 uses a LED to indicate the charge status.

Table 1 Charge Status Indicator

State	LED
Charging	on
Charging Done	off

### High Temperature Fold-back

Build-in feedback circuitry mechanism can reduce the value of the programmed charge current once the die temperature tends to rise above 110°C, hence prevents the temperature from further increase and ensure device safe operation.

### Automatic Recharge

After the termination of the charge cycle, the ETA9882 constantly monitors the BAT pin voltage and starts a new charge cycle when the battery voltage falls more than 170mV, keeping the battery at fully charged condition.

### Battery Temperature Monitoring

When in charging or boost mode, the NTC pin outputs 20uA current to monitor the voltage of NTC pin, then detect the temperature of the battery. NTC function can be disabled by connecting NTC pin to GND.

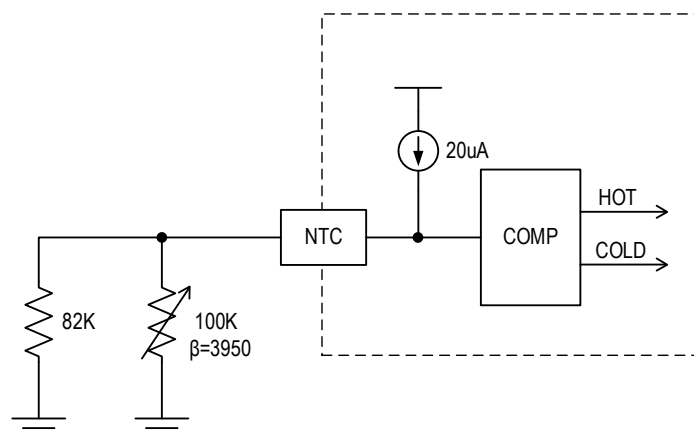

In charging mode: When the voltage of NTC pin is 1.32V, it represents that the battery temperature is 0°C, then stop charging the battery. And when the voltage of NTC pin is 0.56V, it represents that the battery temperature is 45°C, then stop charging the battery.

In boost mode: When the voltage of NTC pin is 1.52V, it represents that the battery temperature is -20°C, then stop boost. And when the voltage of NTC pin is 0.38V, it represents that the battery temperature is 60°C, then stop boost.

### *Boost Operation*

Generally, the boost is working in a fixed constant frequency PWM mode. But for ETA9882, at light load, the boost is working in power saving mode to improve the convert efficiency.

### *Output Short-Circuit Protection*

Unlike most step-up converters, the ETA9882 allows for short circuits on the output. In the event of a short circuit, the device first turns off the high-side MOS when the sensed current reaches the current limit. When  $V_{OUT}$  drops below  $V_{IN}$ , the device then enters a linear charge period with the current limited same as with the start-up period. In addition, the thermal shutdown circuits disable switching if the die temperature rises above 160°C.

## PCB GUIDELINE

Keep the power devices as close to the chip as possible to achieve the smallest power loop area, which leads to the best EMI performance;  $C_{IN}$  is always placed nearest to IN and GND.

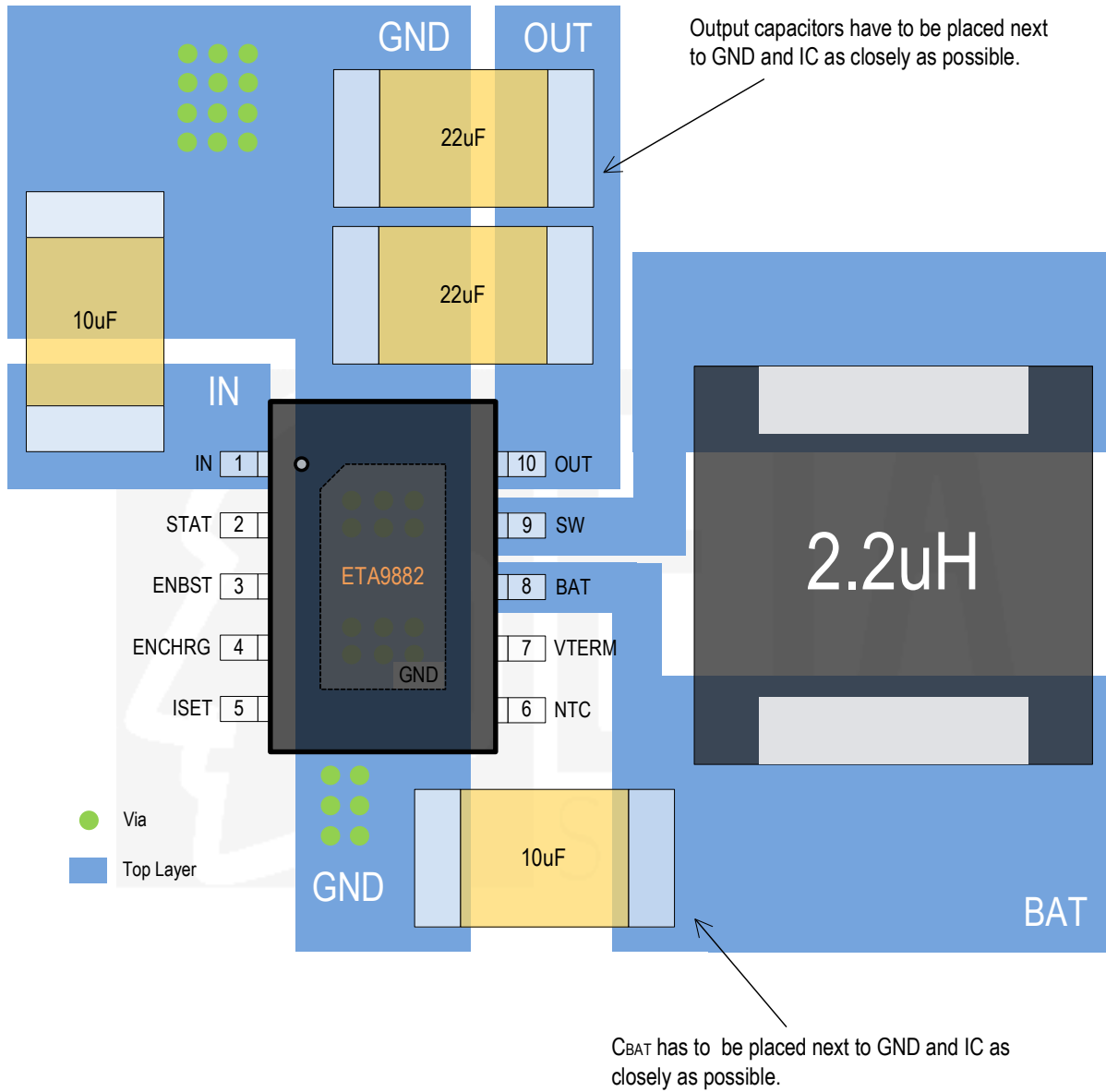



## PACKAGE OUTLINE

Package: ESSOP10

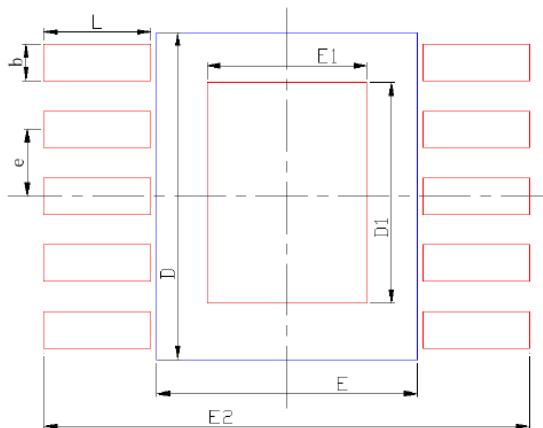
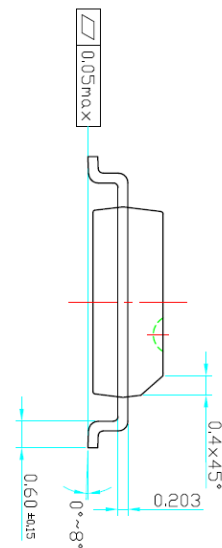
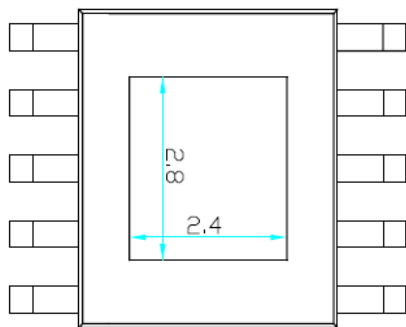
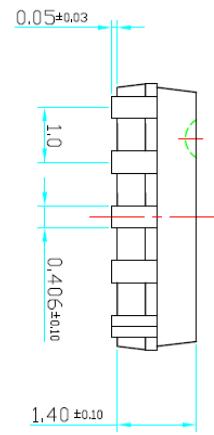
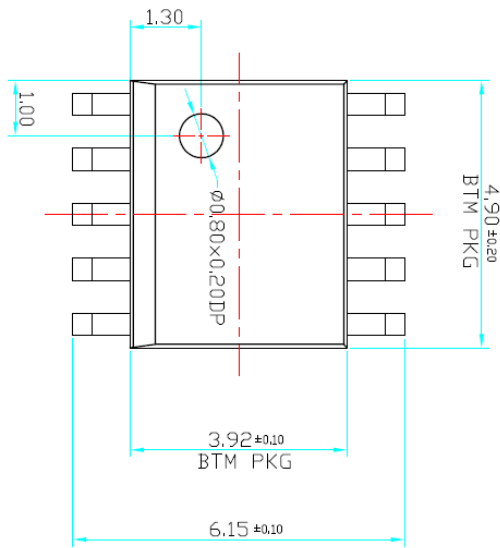

RECOMMENDED LAND PATTERN

Dimensions	Value (in mm)
D	4.9
E	3.92
D1	3.3
E1	2.4
E2	7.3
b	0.55
L	1.6
e	1

## TAPE AND REEL INFORMATION

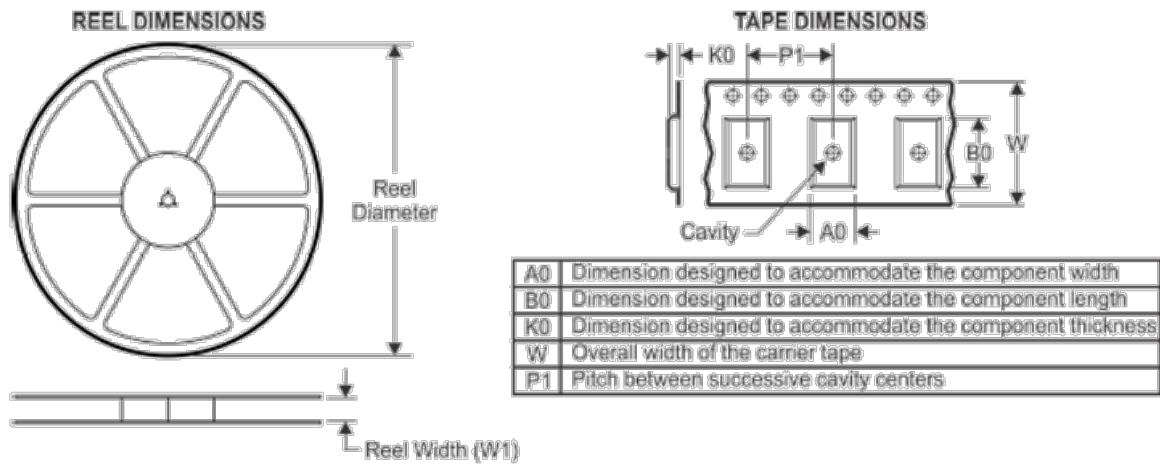

### QUADRANT ASSIGNMENTS FOR PIN 1 ORIENTATION IN TAPE

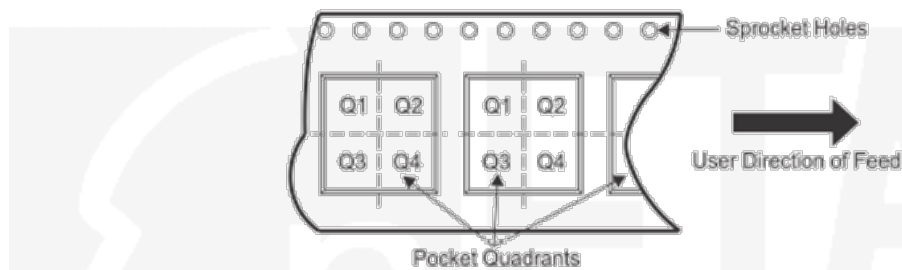

Device	Package Type	Pins	SPQ	Reel Diameter (mm)	Reel Width W1 (mm)	A0 (mm)	B0 (mm)	K0 (mm)	P1 (mm)	W (mm)	Pin1 Quadrant
ETA9882E10	ESSOP10	10	4000	330	12.7	6.6	5.4	2.05	8	12	Q1
ETA9882V435E10	ESSOP10	10	4000	330	12.7	6.6	5.4	2.05	8	12	Q1