

300mA Low-Noise LDO

Without Bypass Capacitor

DESCRIPTION

The EUP7913/A is an efficient CMOS low dropout (LDO) voltage regulator optimized for ultra-low-noise applications. It offers high output accuracy, extremely low dropout voltage, low ground current and fast start-up time. The EUP7913/A provides a very low noise output without a bypass capacitor, ideal for RF applications where a clean supply voltage source is required. Specifically designed for handheld and battery-powered devices, the EUP7913/A provides a TTL-logic-compatible enable pin. When the EUP7913/A is disabled, power consumption drops nearly to zero. Key features include current limit, thermal shutdown and faster transient response.

The EUP7913/A works with low-ESR ceramic capacitors. Available in the SOT23-3 or SOT23-5 space saving package which reduces the amount of board space necessary for power applications. The EUP7913/A offers wide fixed output voltage versions.

FEATURES

- 2.5V to 5.5V Input Voltage Range
- 30 μ V(rms) Output Noise
- 200mV Dropout @ 300mA
- 70dB PSRR at 1kHz No Bypass Capacitor
- Low 30 μ A Ground Current
- Guaranteed 300mA Output Current
- Stable with a 1 μ F Ceramic Output Capacitor When $V_{OUT} \geq 1.5V$, or 2.2 μ F when $V_{OUT} < 1.5V$
- Excellent Load/Line Transient
- Thermal Shutdown and Current Limit Protection
- Available 1.2V to 3.6V fixed output voltages (50mV increments)
- Space-Saving SOT23-3 & SOT23-5 Package
- RoHS Compliant and 100% Lead (Pb)-Free

APPLICATIONS

- Cellular Phones
- Camera Modules
- PDA and Palmtop Computers
- Consumer/Personal Electronics

Block Diagram

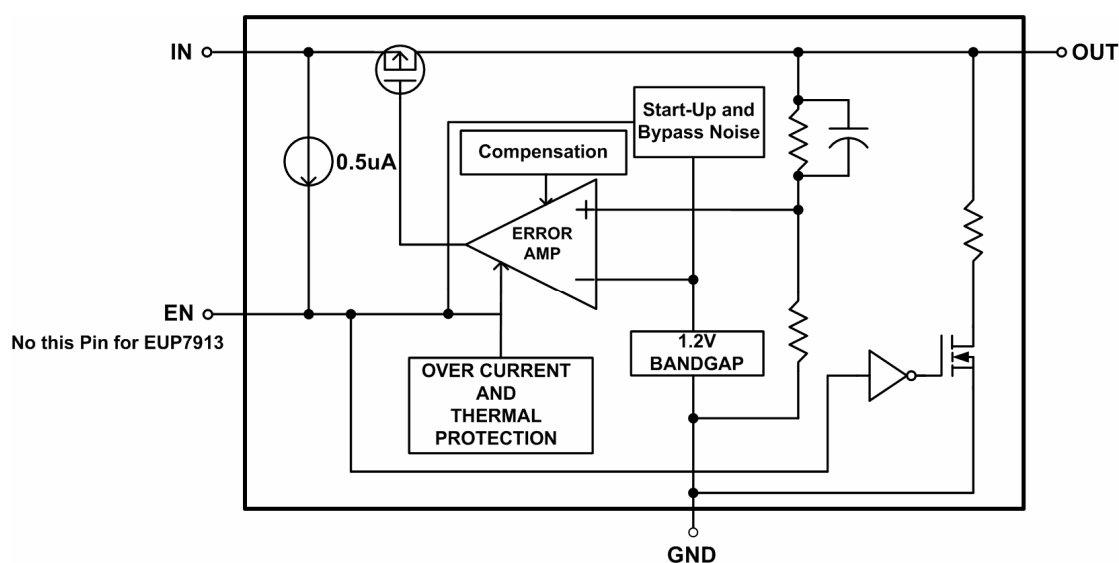

Figure 1.

Typical Application Circuit

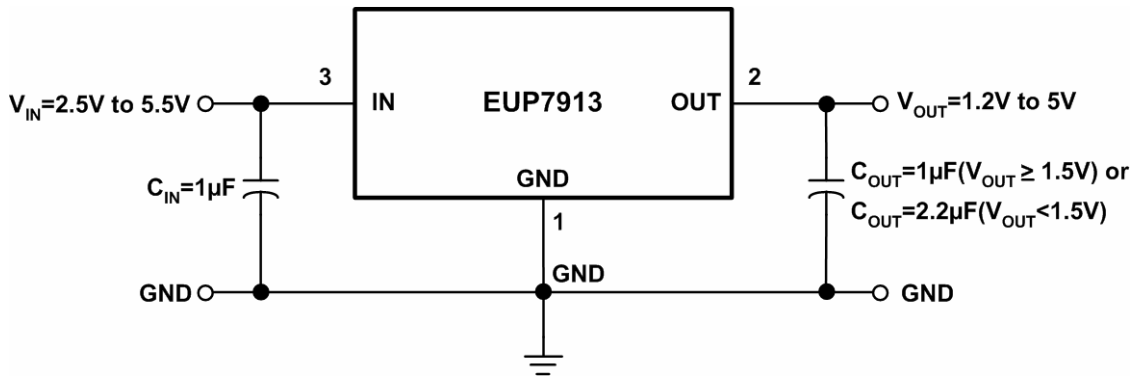

Figure 2. EUP7913 Fixed-Voltage Regulator

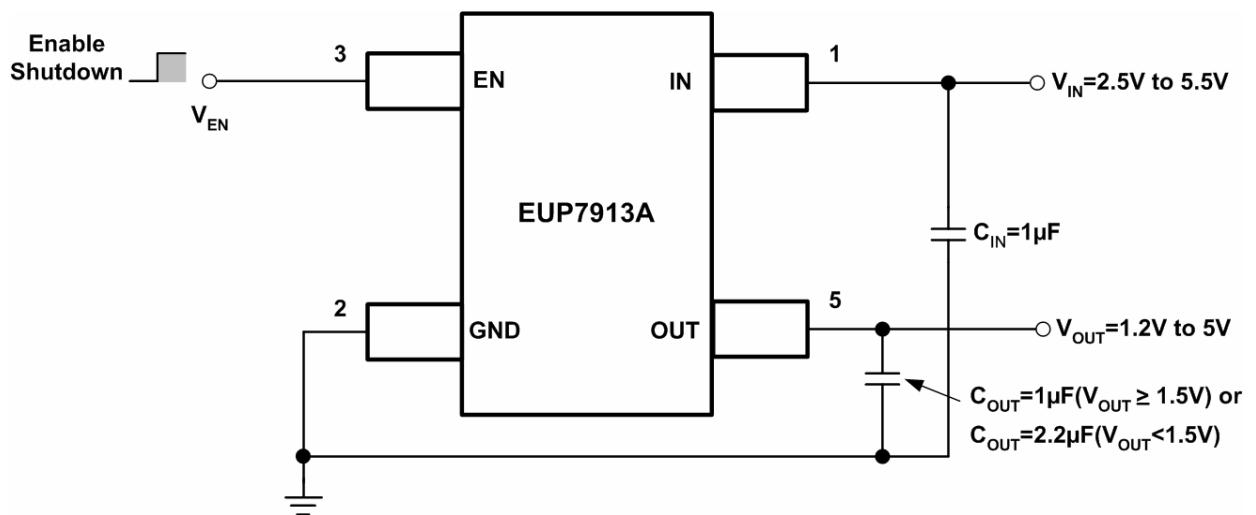

Figure 3. EUP7913A Fixed-Voltage LDO Regulator

Pin Configurations

Package Type	Pin Configurations	Package Type	Pin Configurations
SOT23-3	<p>(Top View)</p>	SOT23-5	<p>(Top View)</p>

Pin Description

NAME	EUP7913 (SOT23-3)	EUP7913A (SOT23-5)	DESCRIPTION
EN	-	3	Active chip for logic high. When EN turns logic low, the devices goes shutdown.
GND	1	2	Ground pin
OUT	2	5	Output voltage of the LDO
IN	3	1	Input voltage of the LDO
NC	-	4	No connected

Ordering Information

Order Number	Package Type	Marking	Operating Temperature Range
EUP7913-12VIR1	SOT23-3	DT xxxx	-40 °C to +85°C
EUP7913-15VIR1	SOT23-3	DC xxxx	-40 °C to +85°C
EUP7913-18VIR1	SOT23-3	DD xxxx	-40 °C to +85°C
EUP7913-25VIR1	SOT23-3	DB xxxx	-40 °C to +85°C
EUP7913-28VIR1	SOT23-3	DE xxxx	-40 °C to +85°C
EUP7913-285VIR1	SOT23-3	DF xxxx	-40 °C to +85°C
EUP7913-30VIR1	SOT23-3	DG xxxx	-40 °C to +85°C
EUP7913-33VIR1	SOT23-3	DH xxxx	-40 °C to +85°C
EUP7913A-12VIR1	SOT23-5	xxxxx AF1T	-40 °C to +85°C
EUP7913A-15VIR1	SOT23-5	xxxxx AF1C	-40 °C to +85°C
EUP7913A-18VIR1	SOT23-5	xxxxx AF1D	-40 °C to +85°C
EUP7913A-25VIR1	SOT23-5	xxxxx AF1B	-40 °C to +85°C
EUP7913A-28VIR1	SOT23-5	xxxxx AF1E	-40 °C to +85°C
EUP7913A-285VIR1	SOT23-5	xxxxx AF1F	-40 °C to +85°C
EUP7913A-30VIR1	SOT23-5	xxxxx AF1G	-40 °C to +85°C
EUP7913A-33VIR1	SOT23-5	xxxxx AF1H	-40 °C to +85°C
EUP7913A-475VIR1	SOT23-5	xxxxx AF1I	-40 °C to +85°C

EUP7913/A-

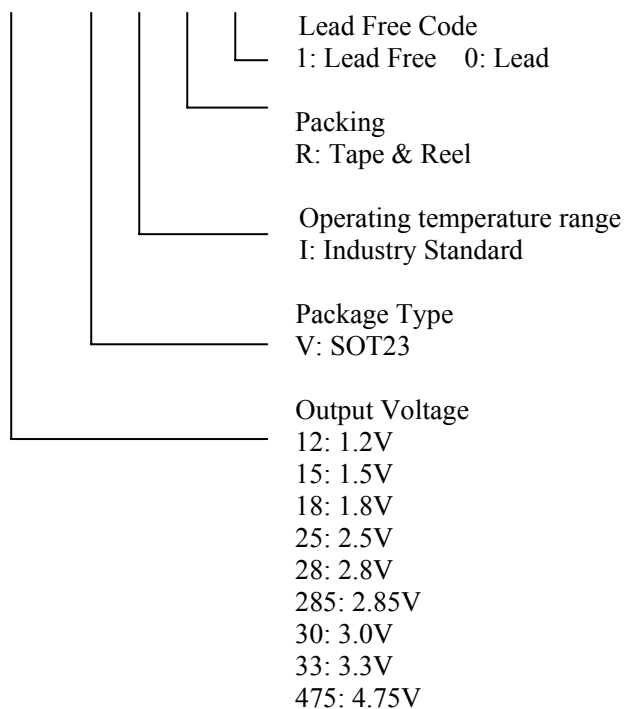

Absolute Maximum Ratings (1)

- IN,OUT and EN to GND----- -0.3V to 6V
- Junction Temperature ----- 150°C
- Storage Temperature Range ----- -65°C to +150°C
- Lead Temperature ----- 260°C
- Thermal Resistance θ_{JA} (SOT23-3) -----250°C/W
- Thermal Resistance θ_{JA} (SOT23-5) -----220°C/W
- ESD Rating
Human Body Model ----- ± 2 kV

Recommend Operating Conditions (2)

- V_{IN} ----- 2.5V to 5.5V
- V_{EN} ----- 0V to 5.5V
- Operating Temperature Range ----- -40°C to +85°C

Note (1): Stress beyond those listed under “Absolute Maximum Ratings” may damage the device.

Note (2): The device is not guaranteed to function outside the recommended operating conditions.

Electrical Characteristics

Conditions: $V_{IN}=V_{OUT}+0.5V$ or 2.5V whichever is greater, $V_{EN}=V_{IN}$, $C_{IN}=C_{OUT}=1\mu F$, $T_A = -40^\circ C$ to $+85^\circ C$, Unless otherwise specified.

Symbol	Parameter	Conditions	EUP7913			Unit
			Min	Typ	Max.	
	Input Voltage		2.5		5.5	V
ΔV_{OUT}	Output Voltage Accuracy	$I_{OUT}=1mA$ to $30mA$, $T_A = +25$	-2		2	%
		$I_{OUT}=1mA$ to $30mA$, $T_A = -40$ to $+85$	-3.0		3.0	
I_{OUTMAX}	Maximum Output Current		300			mA
I_{LIMIT}	Current Limit	$V_{OUT}=V_{OUT(nom)} \times 90\%$		550		mA
V_{DROP}	Dropout Voltage (Note3)	$V_{OUT} \geq 3V$, $I_{OUT}=300mA$		180	260	mV
		$2.4 \leq V_{OUT} \leq 3V$, $I_{OUT}=300mA$		200	300	
I_Q	Quiescent Current	No Load		30	50	μA
V_{LNR}	Line Regulation	$V_{IN}=(V_{OUT}+0.5V)$ to 5.5V, $I_{OUT}=10mA$		0.02	0.15	%/V
V_{LDR}	Load Regulation	$1mA \leq I_{OUT} \leq 300mA$		15	30	mV
I_{SHDN}	Shutdown Supply Current	$V_{EN}=0$, $T_A = +25$ (EUP7913A)		0.3	1.5	μA
PSRR	Power Supply Ripple Rejection	$V_{IN}=(V_{OUT}+1V)$ $f=1kHz$, $I_{LOAD}=10mA$		70		dB
		$V_{IN}=(V_{OUT}+1V)$ $f=10kHz$, $I_{LOAD}=10mA$		60		
		$V_{IN}=(V_{OUT}+1V)$ $f=100kHz$, $I_{LOAD}=10mA$		45		
	Output Noise Voltage (RMS)	$f=10Hz \sim 100kHz$, $V_{OUT}=1.5V$, No Load		30		μV
	Turn-on Time (Note4)	$R_{LOAD}=50\Omega$, $T_A = +25$		100		μs
V_{ENL}	VENL (EN logic low)	$V_{IN}=2.5V$ to 5.5V (EUP7913A)			0.4	V
V_{ENH}	VENH (EN logic high)	$V_{IN}=2.5V$ to 5.5V (EUP7913A)	1.5			V
	VEN Input Bias Current	$V_{IN}=5.5V$, $V_{EN}=0$ or 5.5V (EUP7913A)	-1		1	μA
RDIS	Output Discharge Switch	$V_{EN}=0$, $V_{IN}=3.6V$		550		Ω
T_{SD}	Thermal Shutdown Temperature			155		$^\circ C$
ΔT_{SD}	Thermal Shutdown Hysteresis			15		$^\circ C$
Rdischarge	V_{OUT} Discharge Resistance	$V_{EN}=0$ (EUP7913A)		500		Ω

Note (3): Dropout is defined as $V_{IN}-V_{OUT}$ when V_{OUT} is 100mV below the value of V_{OUT} for $V_{IN}=V_{OUT}+0.5V$

Note (4): Time needed for V_{OUT} to reach 90% of final value.

Typical Characteristics ($C_{IN}=C_{OUT}=2.2\mu F$)

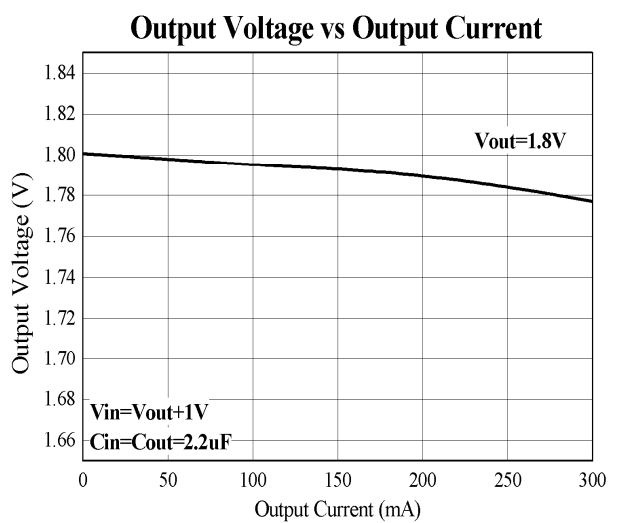
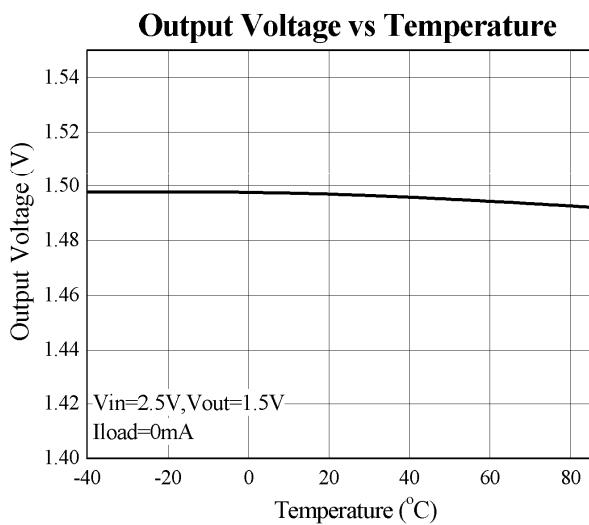
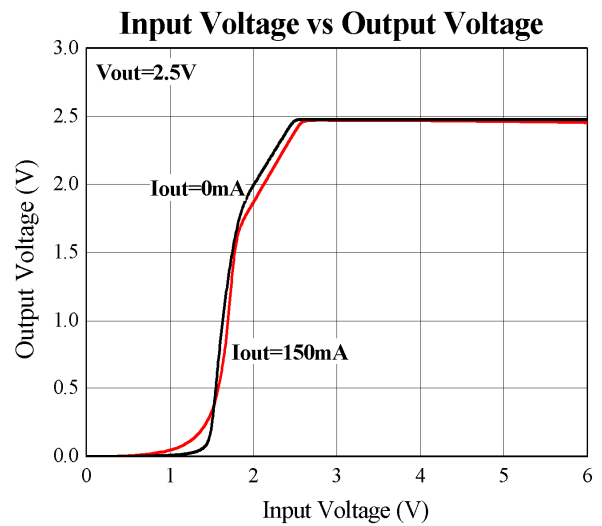
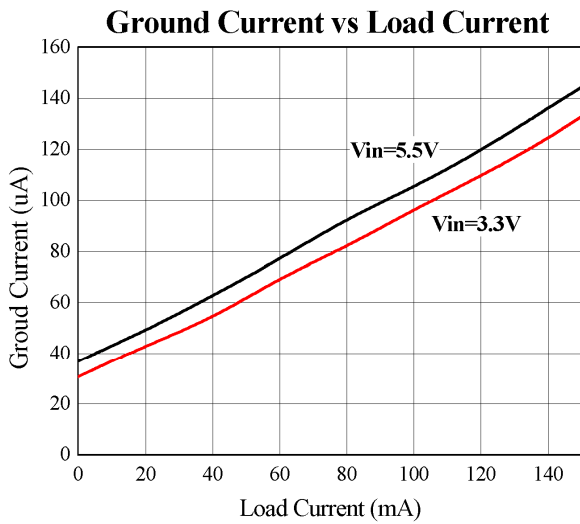
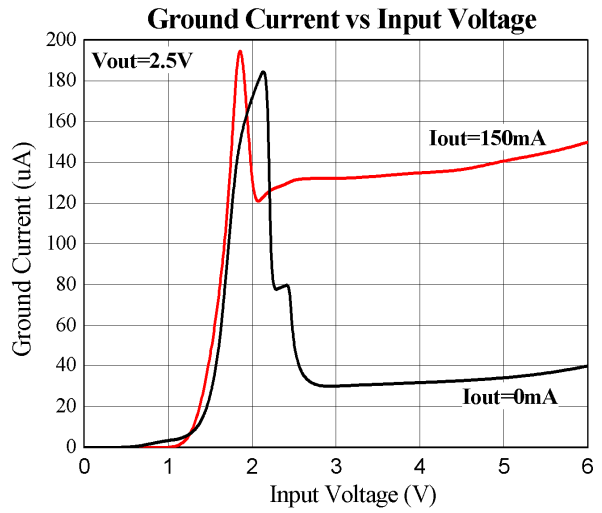
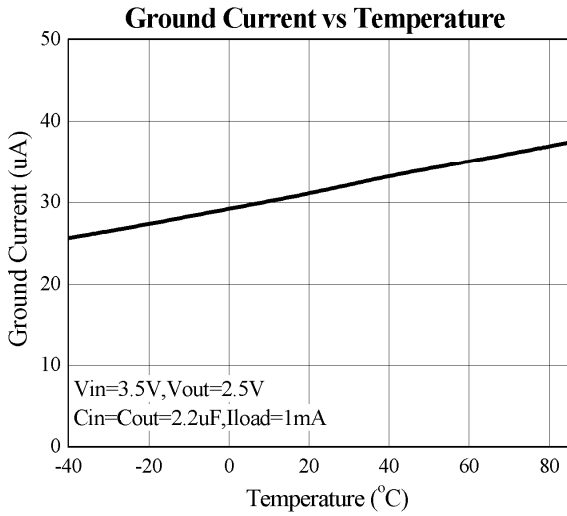

Typical Characteristics (continued)

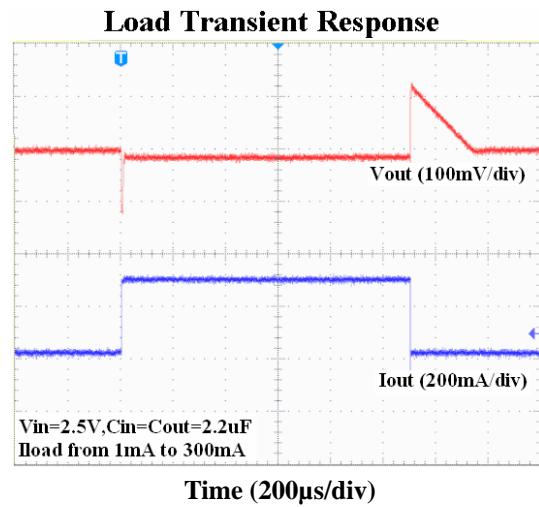
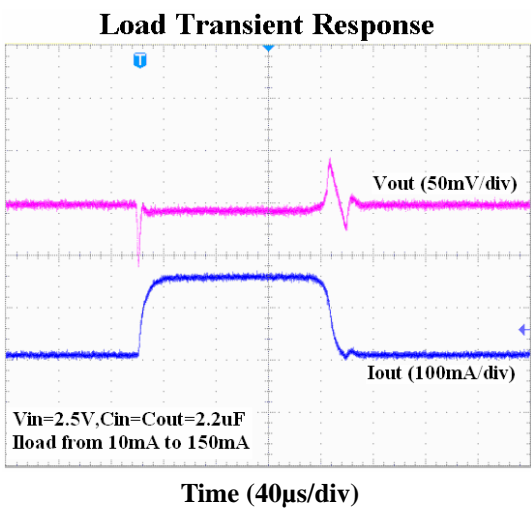
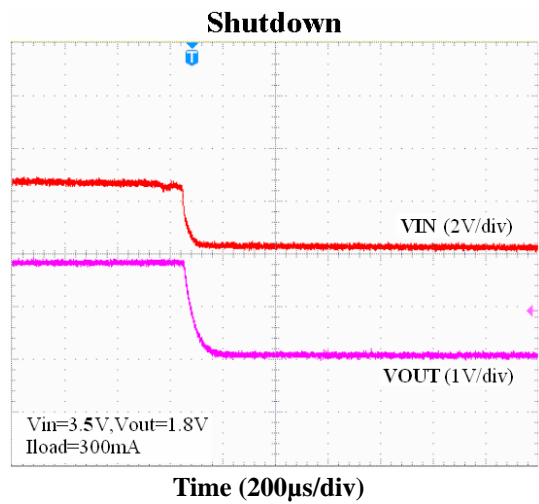
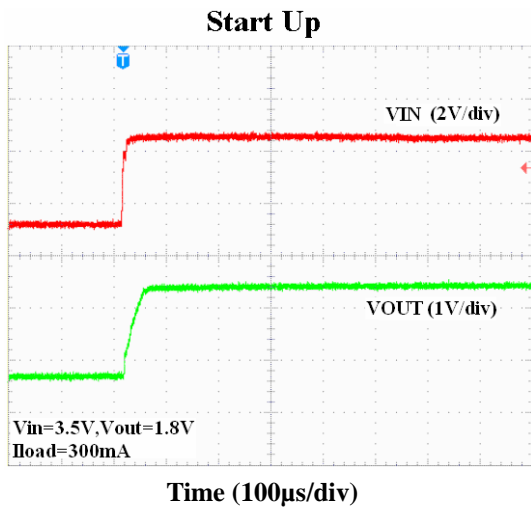
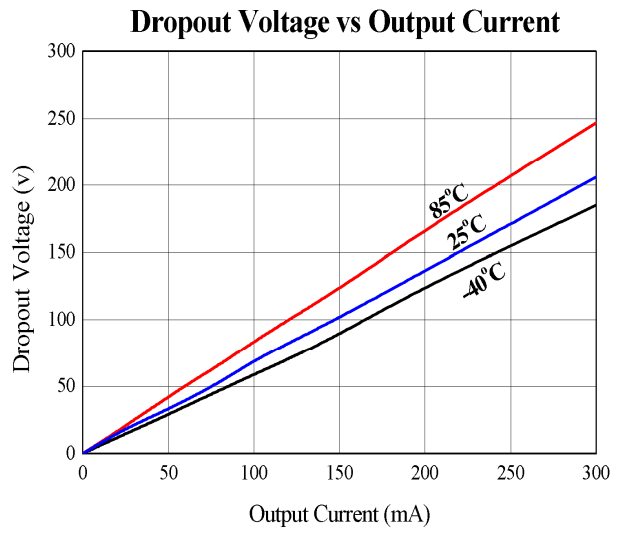
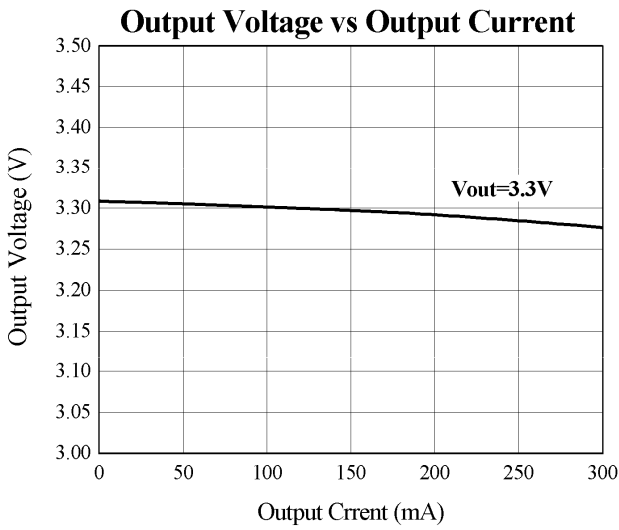

Typical Characteristics (continued)

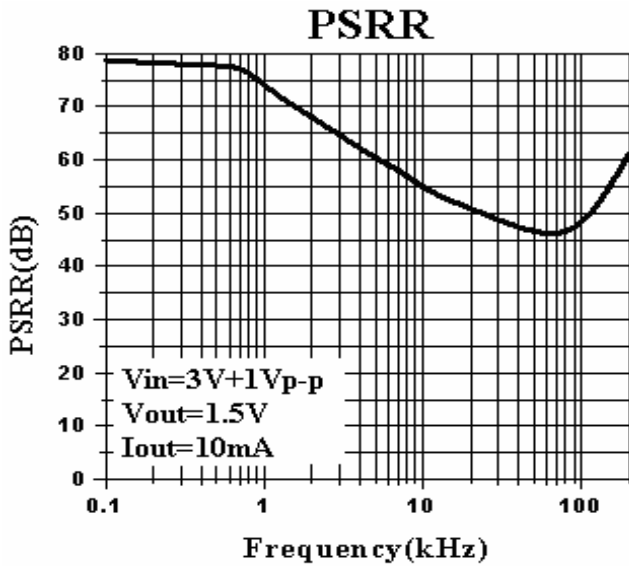
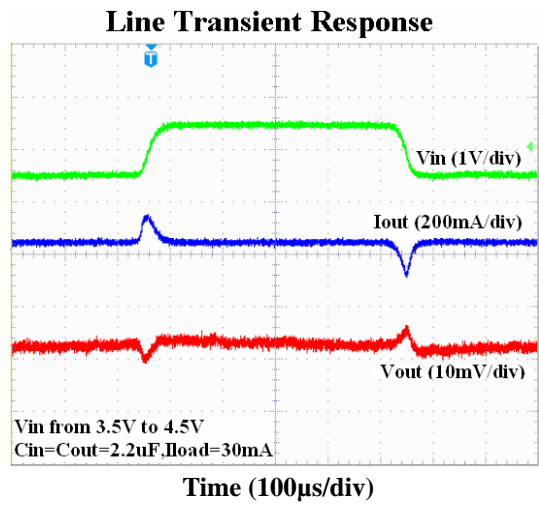
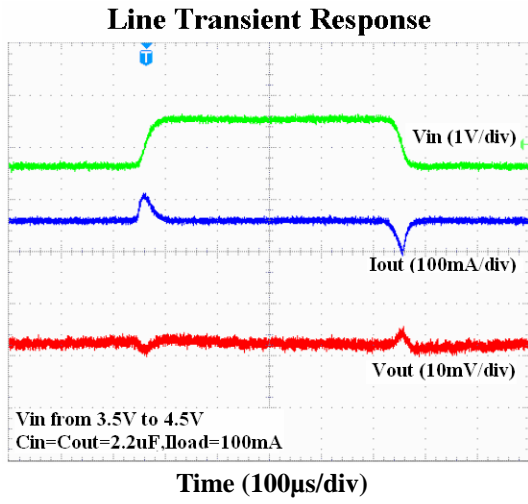

Application Note

Input Capacitor

An input capacitance of 1 μ F or higher is required between the EUP7913/A input pin IN and ground (the amount of the capacitance may be increased without limit). This capacitor must be located a distance of not more than 1cm from the input pin and returned to a clean analog ground. Any good quality ceramic, tantalum, or film capacitor may be used at the input. If a tantalum capacitor is used at the input, it must be guaranteed by the manufacturer to have a surge current rating sufficient for the application. There are no requirements for the ESR on the input capacitor, but tolerance and temperature coefficient must be considered when selecting the capacitor to ensure the capacitance will be 1 μ F over the entire operating temperature range.

Output Capacitor

The EUP7913/A is designed specifically to work with very small ceramic output capacitors. A ceramic capacitor (temperature characteristics X7R or X5R) in 1 μ F to 10 μ F range with 5m Ω to 500m Ω ESR range is suitable in the EUP7913/A application circuit. The output capacitor must meet the requirement for minimum amount of capacitance to maintain good loop stability and phase margin. See the table below.

Output Voltage	Output Capacitor Minimum Value
1.2~1.45	2.2 μ F
1.5~3.6	1 μ F

No-Load Stability

The EUP7913/A is stable without any external load. This is specially important for CMOS RAM keep-alive applications.

On/Off Input Operation

The EUP7913A is turned off by pulling the EN pin low, and turned on by pulling it high. If this pin is floating, the regulator will always be on. To assure proper operation, the signal source used to drive the V_{EN} input must be able to swing above and below the specified turn-on/off voltage thresholds listed in the Electrical Characteristics. When EN is logic low, output is internally discharged to GND through a 500 resistor.

Packaging Information

SOT23-3

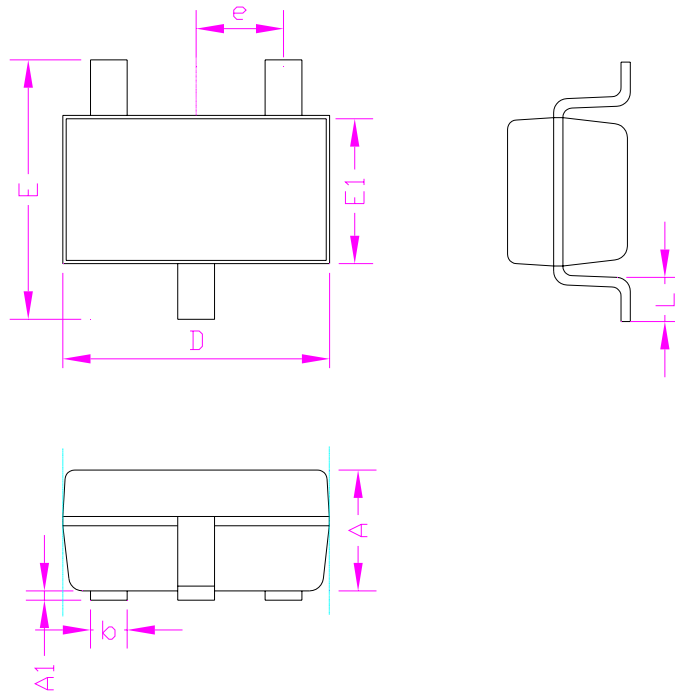

SYMBOLS	MILLIMETERS		INCHES	
	MIN.	MAX.	MIN.	MAX.
A	-	1.30	-	0.052
A1	0.00	0.15	0.000	0.006
D	2.90		0.114	
E1	1.60		0.063	
E	2.60	3.00	0.102	0.118
L	0.30	0.60	0.012	0.024
b	0.30	0.50	0.012	0.020
e	0.95		0.037	

SOT23-5

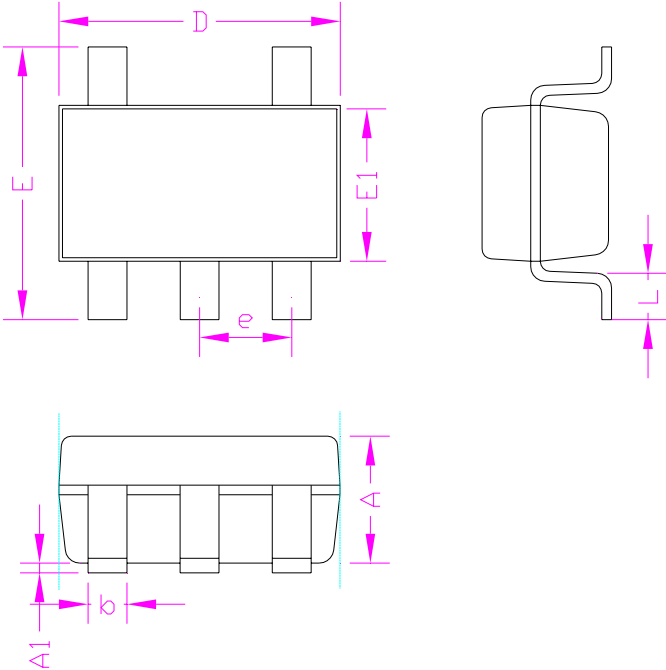

SYMBOLS	MILLIMETERS		INCHES	
	MIN.	MAX.	MIN.	MAX.
A	-	1.30	-	0.052
A1	0.00	0.15	0.000	0.006
D	2.90		0.114	
E1	1.60		0.063	
E	2.60	3.00	0.102	0.118
L	0.30	0.60	0.012	0.024
b	0.30	0.50	0.012	0.020
e	0.95		0.037	