

# 1.5A Linear Li-Ion/Polymer Charger IC with Integrated FET and Charger Timer

## DESCRIPTION

The EUP8092 series are highly integrated single cell Li-Ion/Polymer battery charger IC designed for handheld devices. This charger is designed to work with various types of AC adapters or a USB port and capable of operating with an input voltage as low as 2.65V.

The EUP8092 operates as a linear charger and charges the battery in three phases: trickle current, constant current, and constant voltage. When AC-adaptor is applied, an external resistor sets the magnitude of the charge current, which may be programmed up to 1.5A with TDFN10 package and a current-limited adapter for lowest power dissipation.

The EUP8092 features thermal regulation loop to control charge current to keep safe operation when PCB lacked of enough heat-sinking. A programmable charge timer provides a backup safety for termination. The EUP8092 automatically re-starts the charge if the battery voltage falls below an internal threshold and automatically enters sleep mode when DC supplies are removed. No external sense resistor or blocking diode is required for charging. A NTC thermistor interface is used for charging the battery in a safe temperature range.

## FEATURES

- Very Low Power Dissipation
- Accepts Multiple Types of Adapters or USB BUS Power
- Integrated Power FET and Current Sensor for Up to 1.5A Charge Applications
- Guaranteed to Operate at 2.65V After Start-Up
- Charge Termination by Minimum Current and Time
- Precharge Conditioning With Safety Timer
- Reverse Leakage Protection Prevents Battery Drainage
- Charge Current Thermal Regulation
- Status Outputs for LED or System Interface Indicates Charge and Fault Conditions
- Optional Battery Temperature Monitoring Before and During Charge
- Automatic Sleep Mode for Low-Power Consumption
- Available in 3mm×3mm TDFN-10 and 5mm×5mm TQFN-16 Packages
- RoHS Compliant and 100% Lead (Pb)-Free

## APPLICATIONS

- PDAs, Cell Phones and Smart Phones
- Portable Instruments.
- Stand-Alone Charger.
- USB Bus Powered Charger.

## Typical Application Circuit

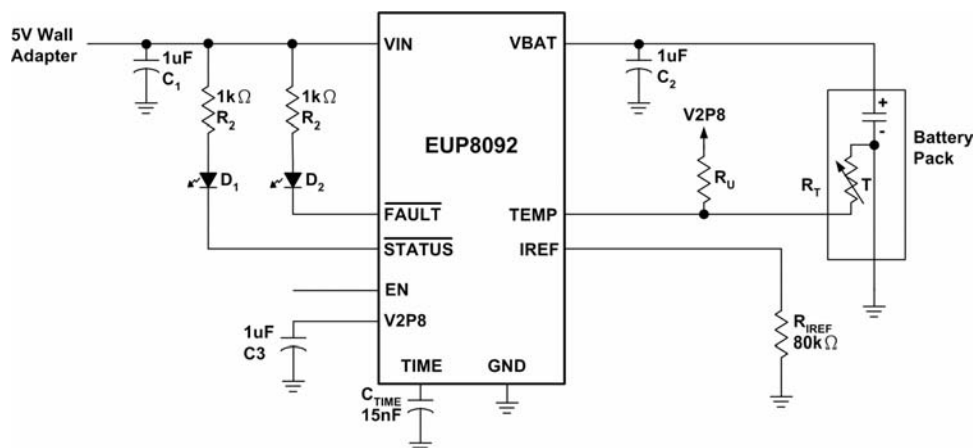


Figure 1.

**Block Diagram**

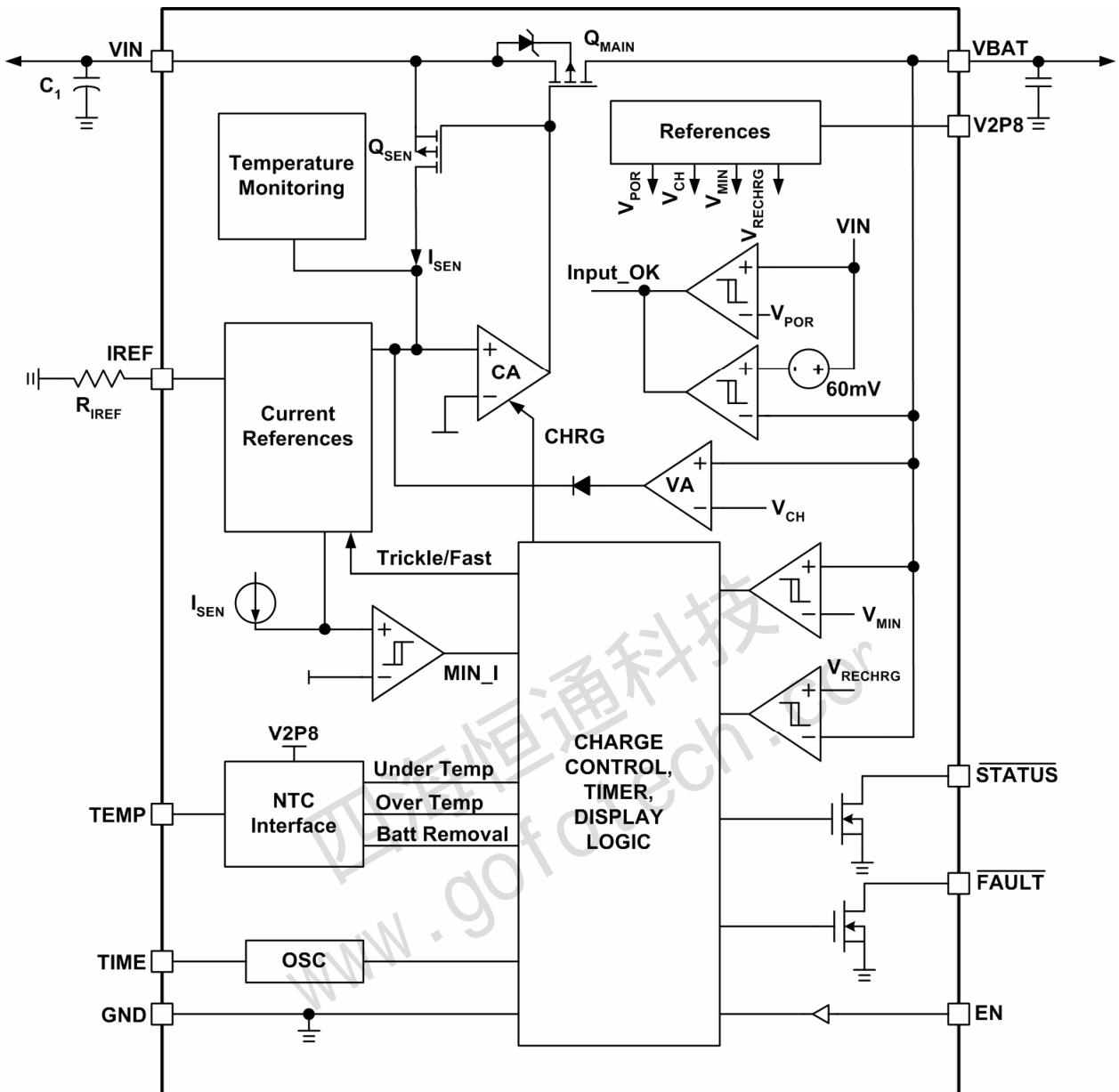


Figure 2.


**Pin Configurations**

Package Type	Pin Configurations	Package Type	Pin Configurations
TDFN-10	<p>(Top View)</p>	TQFN-16	<p>(Top View)</p>

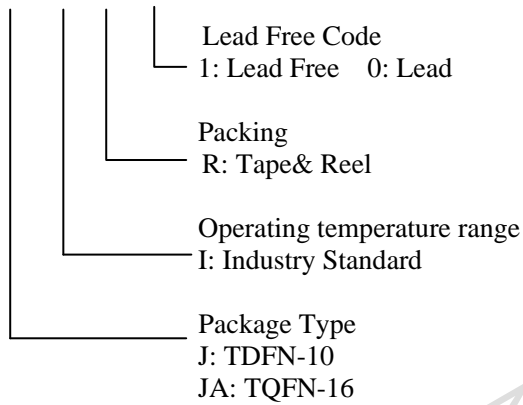
**Pin Description**

PIN	TDFN-10	TQFN-16	DESCRIPTION
VIN	1	1,15,16	VIN is the input power source. Connect to a wall adapter.
$\overline{\text{FAULT}}$	2	2	FAULT is an open-drain output indicating fault status. This pin is pulled to LOW under any fault conditions.
$\overline{\text{STATUS}}$	3	3	STATUS is an open-drain output indicating charging and inhibit states. The STATUS pin is pulled LOW when the charger is charging a battery.
TIME	4	4	The TIME pin determines the oscillation period by connecting a timing capacitor between this pin and GND. The oscillator also provides a time reference for the charger.
GND	5	5	GND is the connection to system ground.
EN	6	7	EN is the enable logic input. Connect the EN pin to LOW to disable the charger or leave it floating to enable the charger.
V2P8	7	8	This is a 2.8V reference voltage output. This pin outputs a 2.8V voltage source when the input voltage is above POR threshold and outputs zero otherwise. The V2P8 pin can be used as an indication for adapter presence.
IREF	8	9	This is the programming input for the constant charging current.
TEMP	9	11	TEMP is the input for an external NTC thermistor. The TEMP pin is also used for battery removal detection.
VBAT	10	12,13,14	VBAT is the connection to the battery. Typically a 1 $\mu$ F Tantalum capacitor is needed for stability when there is no battery attached. When a battery is attached, only a 0.1 $\mu$ F ceramic capacitor is required.
NC	-	6,10	No connect.

**Ordering Information**

Order Number	Package Type	Marking	Operating Temperature Range	VBAT (V)	VSEN	TEMP	TIMEOUT
EUP8092JIR1	TDFN-10	XXXXX 8092D 3H	-20 °C to 70°C	4.2	NO	YES	YES
EUP8092JAIR1	TQFN-16	 XXXXX EUP8092 3H	-20 °C to 70°C	4.2	NO	YES	YES

EUP8092 □□□□□



四海恒通科技  
 www.gofotech.com

**Absolute Maximum Ratings**

- Supply Voltage (VIN) ----- -0.3V to 7V
- Output Pin Voltage (VBAT) ----- -0.3V to 5.5V
- Signal Input Voltage (EN, TIME, IREF) ----- -0.3V to 7V
- Output Pin Voltage ( $\overline{\text{STATUS}}$ ,  $\overline{\text{FAULT}}$ ) ----- -0.3V to 5.5V
- Junction temperature range,  $T_J$  ----- 150°C
- Storage temperature range,  $T_{stg}$  ----- -65°C to 150°C
- Lead temperature (soldering, 10s) ----- 260°C
- ESD protection ----- 2kV

**Dissipation Ratings**

Package	$\theta_{JA}$	$T_A < 40^\circ\text{C}$ Power Rating	Derating Factor Above $T_A = 25^\circ\text{C}$
TDFN-10	48°C/W	1.5W	0.0208 W/°C
TQFN-16	35°C/W	2W	0.0285 W/°C

**Recommended Operating Conditions**

	Min.	Max.	Unit
Supply voltage ,VIN	4.3	6.5	V
Ambient Temperature Range	-20	70	°C

**Electrical Characteristics**

Typical values are tested at VIN = 5V and +25°C Ambient Temperature, maximum and minimum values are guaranteed over 0°C to +70°C Ambient Temperature with a supply voltage in the range of 4.3V to 6.5V, unless otherwise noted.

Symbol	Parameter	Conditions	EUP8092			Unit
			Min.	Typ.	Max.	
<b>POWER-ON RESET</b>						
	Rising VIN Threshold		3.0	3.4	4.0	V
	Falling VIN Threshold		2.25	2.4	2.65	V
<b>STANDBY CURRENT</b>						
$I_{\text{STANDBY}}$	VBAT Pin Sink Current	VIN floating or EN = LOW	-	-	3.0	μA
$I_{\text{VIN}}$	VIN Pin Supply Current	VBAT floating and EN pulled low	-	30	-	μA
$I_{\text{VIN}}$	VIN Pin Supply Current	VBAT floating and EN floating	-	1	-	mA
<b>VOLTAGE REGULATION</b>						
$V_{\text{CH}}$	Output Voltage		4.158	4.20	4.242	V
	Dropout Voltage	VBAT = 3.7V, 0.5A, 3X3 package	-	170	-	mV
<b>CHARGE CURRENT</b>						
$I_{\text{CHARGE}}$	Constant Charge Current	$R_{\text{IREF}} = 80\text{k}\Omega$ , VBAT = 3.7V	0.9	1.0	1.1	A
$I_{\text{TRICKLE}}$	Trickle Charge Current	$R_{\text{IREF}} = 80\text{k}\Omega$ , VBAT = 2.0V	-	110	-	mA
$I_{\text{CHARGE}}$	Constant Charge Current	IREF Pin Voltage > 1.2V, VBAT = 3.7V	400	450	520	mA

**Electrical Characteristics (continued)**

Typical values are tested at VIN = 5V and +25°C Ambient Temperature, maximum and minimum values are guaranteed over 0°C to +70°C Ambient Temperature with a supply voltage in the range of 4.3V to 6.5V, unless otherwise noted.

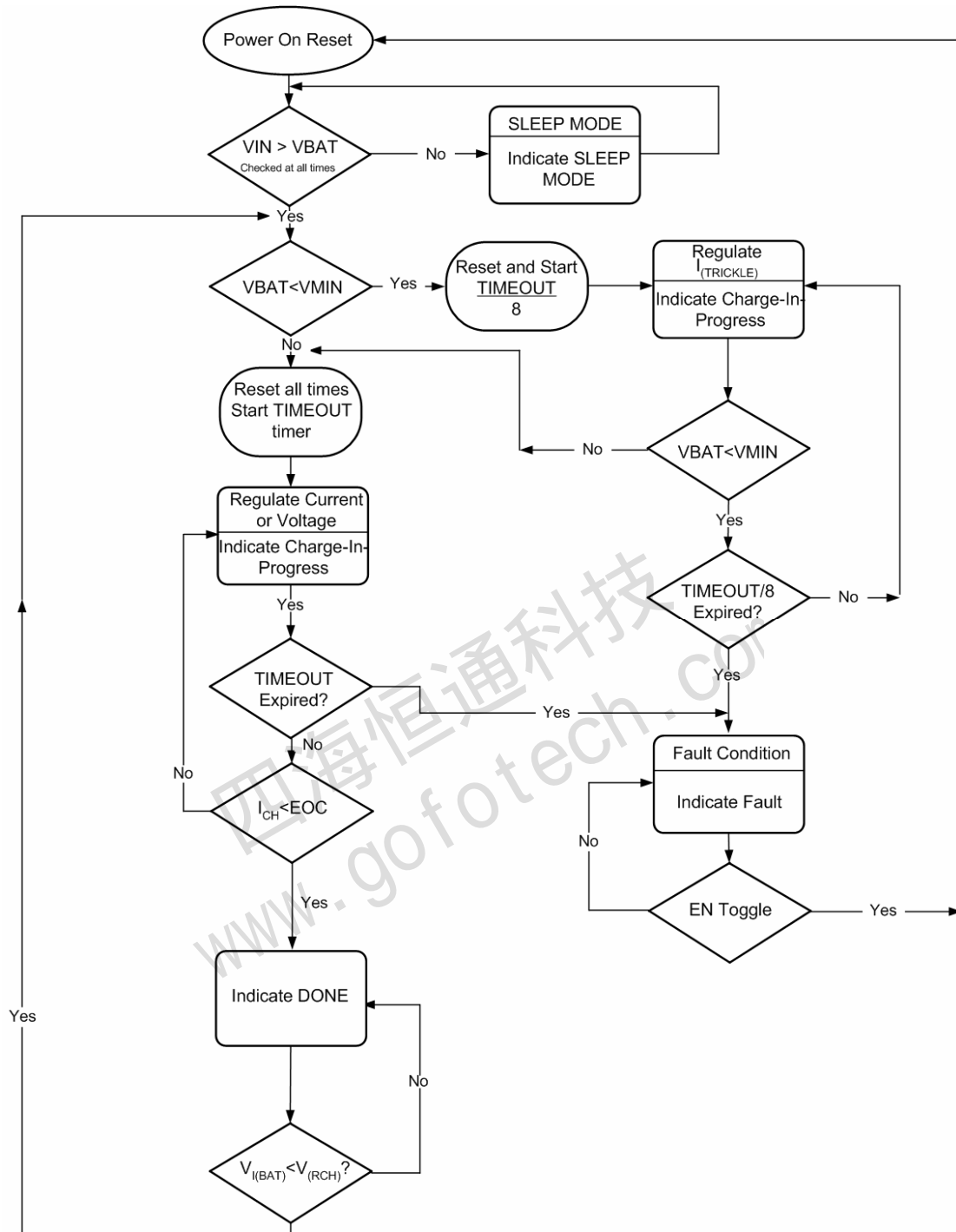
Symbol	Parameter	Conditions	EUP8092			Unit
			Min.	Typ.	Max.	
<b>CHARGE CURRENT</b>						
I <sub>TRICKLE</sub>	Trickle Charge Current	IREF Pin Voltage > 1.2V, VBAT = 2.0V	-	50	-	mA
I <sub>CHARGE</sub>	Constant Charge Current	IREF Pin Voltage < 0.4V, VBAT = 3.7V	-	-	100	mA
I <sub>TRICKLE</sub>	Trickle Charge Current	IREF Pin Voltage < 0.4V, VBAT = 2.0V	-	10	-	mA
EOC	End-of-Charge Threshold		80	115	140	mA
<b>RECHARGE THRESHOLD</b>						
V <sub>RECHRG</sub>	Recharge Voltage Threshold		-	4.0	-	V
<b>TRICKLE CHARGE THRESHOLD</b>						
V <sub>MIN</sub>	Trickle Charge Threshold Voltage		2.7	2.85	3	V
<b>TEMPERATURE MONITORING</b>						
V <sub>TMIN</sub>	Low Battery Temperature Threshold	V2P8 = 3.0V	1.45	1.51	1.57	V
V <sub>TMAX</sub>	High Battery Temperature Threshold	V2P8 = 3.0V	0.36	0.38	0.40	V
V <sub>RMV</sub>	Battery Removal Threshold	V2P8 = 3.0V	-	2.25	-	V
T <sub>FOLD</sub>	Charge Current Foldback Threshold		95	110	125	°C
<b>OSCILLATOR</b>						
T <sub>OSC</sub>	Oscillation Period	C <sub>TIME</sub> = 15nF	2.4	3	3.6	ms
<b>LOGIC INPUT AND OUTPUT</b>						
	IREF Input High		1.2	-	-	V
	IREF IMIN Input Low		-	-	0.1	V
	STATUS/FAULT Sink Current	Pin Voltage = 0.8V	5	-	-	mA

$$(1) I_{O(OUT)} = \left( \frac{10^5 \times 0.8V}{R_{IREF}} \right)$$

$$(2) I_{O(PRECHG)} = \left( \frac{10^4 \times 0.8V}{R_{IREF}} \right)$$

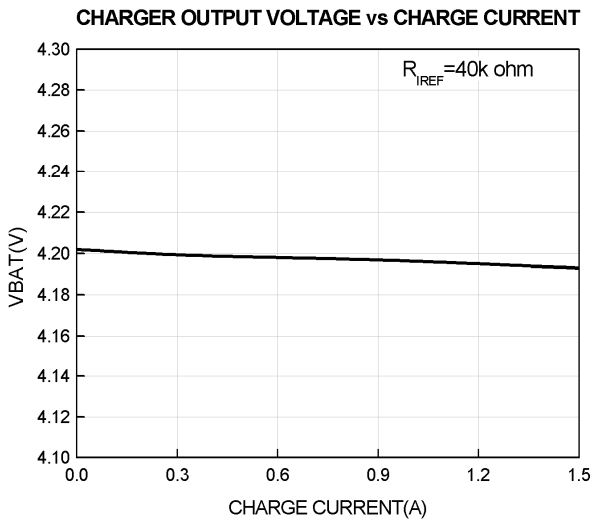
$$(3) I_{O(EOC)} = \left( \frac{10^4 \times 0.8V}{R_{IREF}} \right)$$

**Application Information**

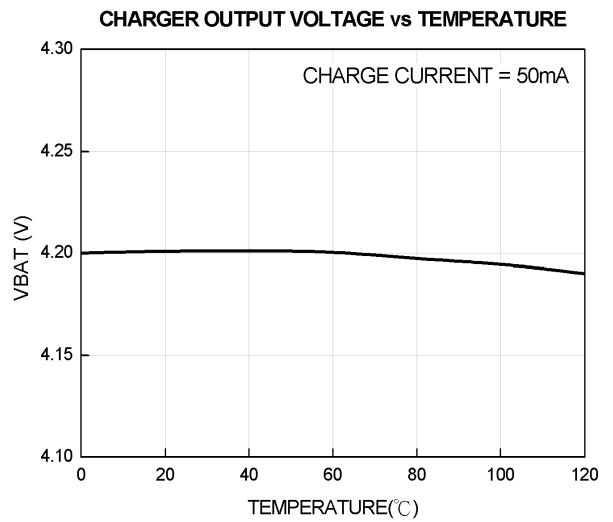


**Figure 3. Operational Flow Chart**

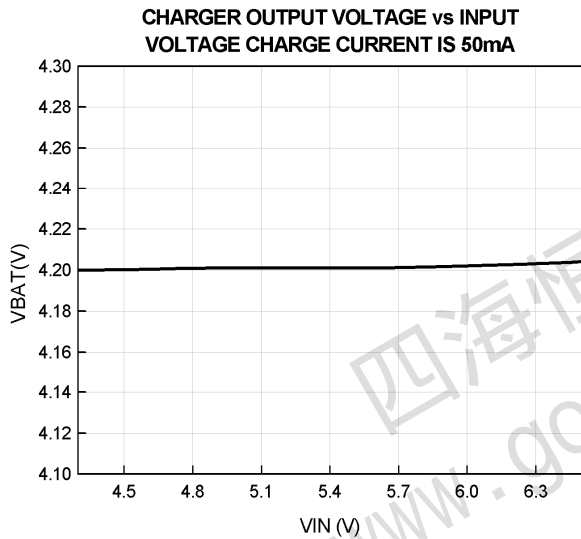
**Typical Operating Characteristics**



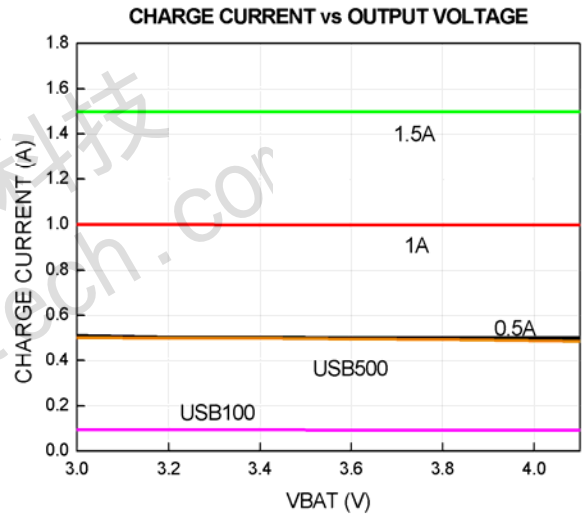
**Figure 4.**



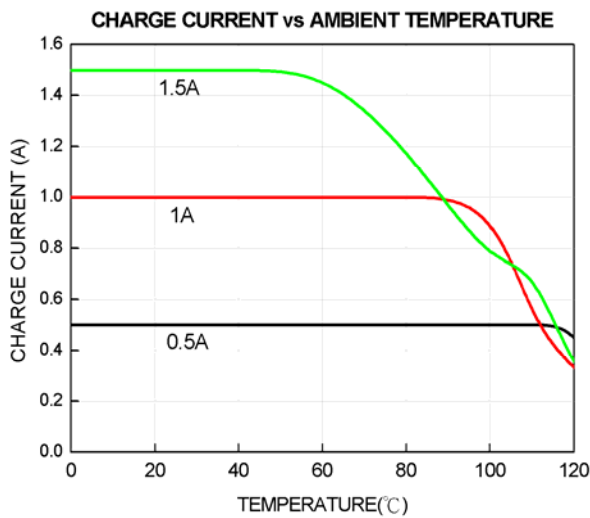
**Figure 5.**



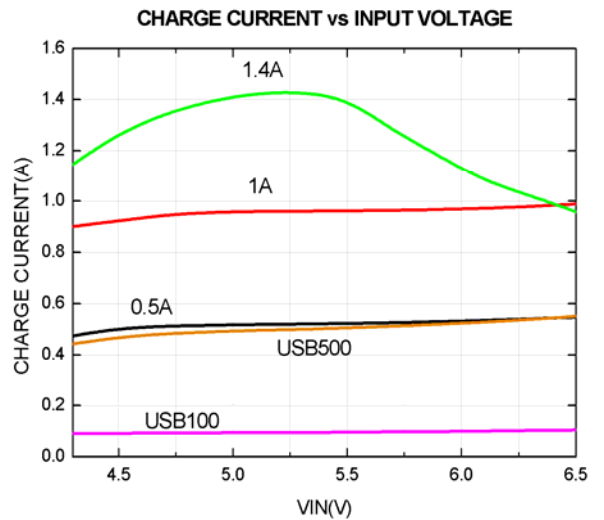
**Figure 6.**



**Figure 7.**



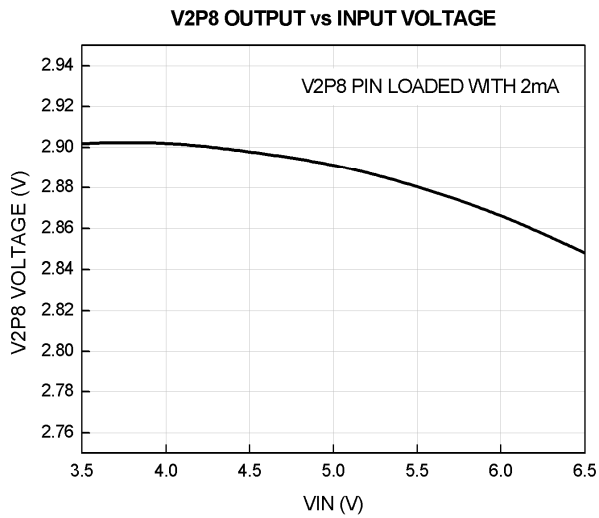
**Figure 8.**



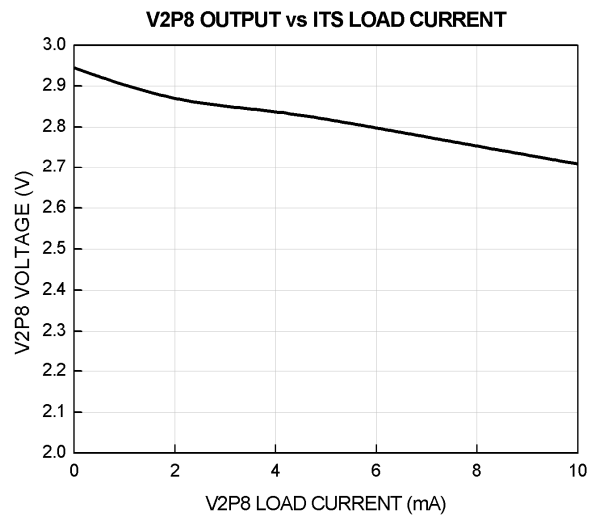
**Figure 9.**



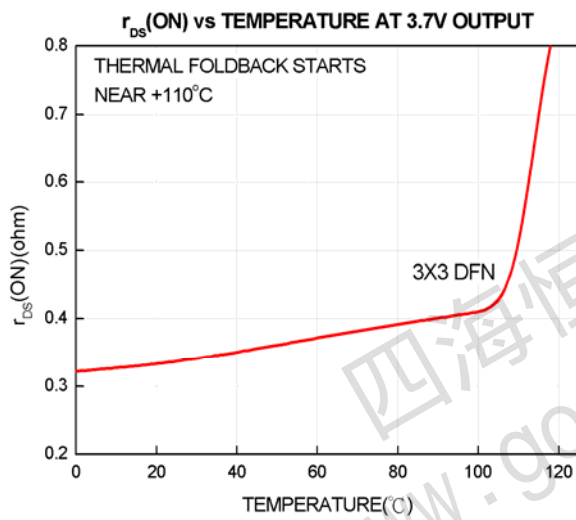
**Typical Operating Characteristics (continued)**



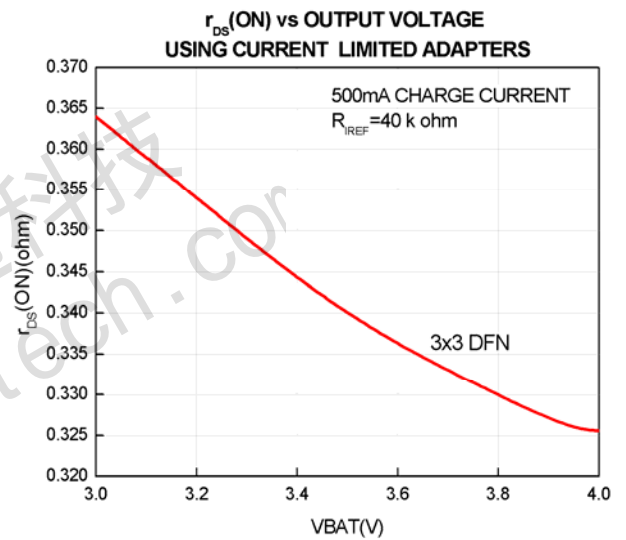
**Figure 10.**



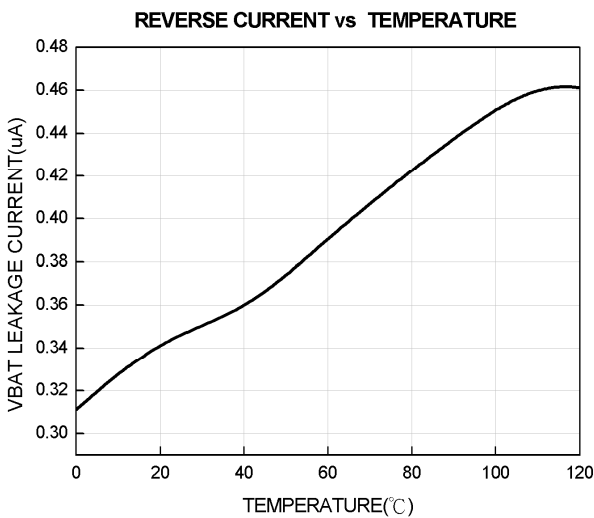
**Figure 11.**



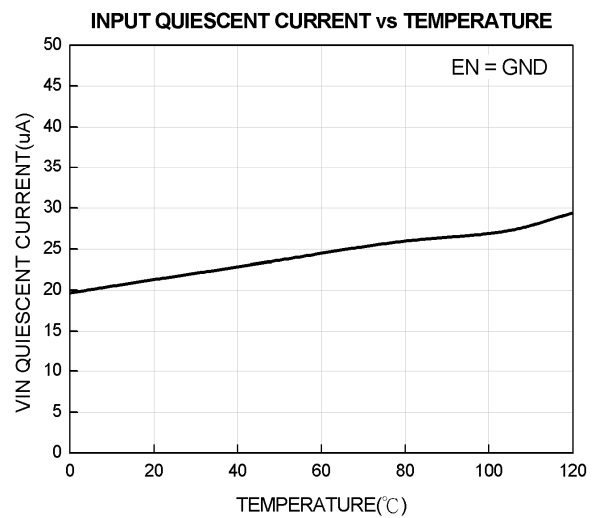
**Figure 12.**



**Figure 13.**

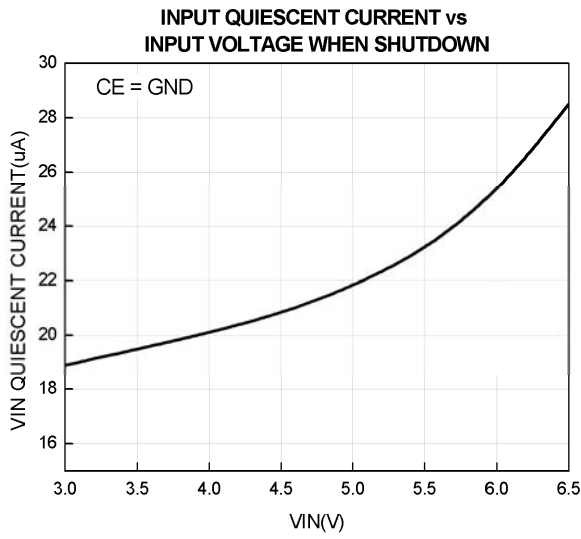


**Figure 14.**

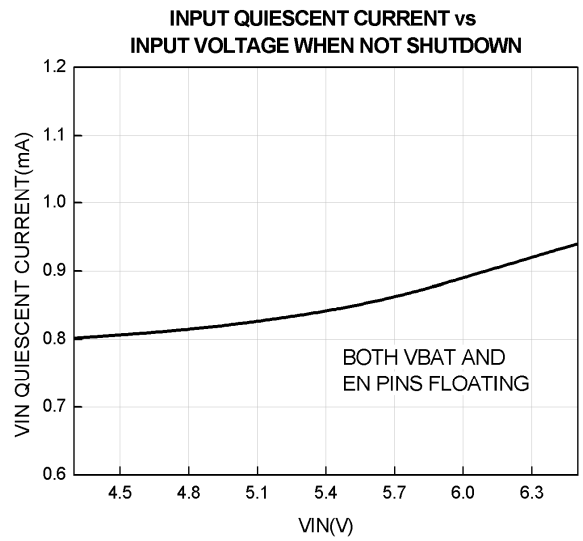


**Figure 15.**

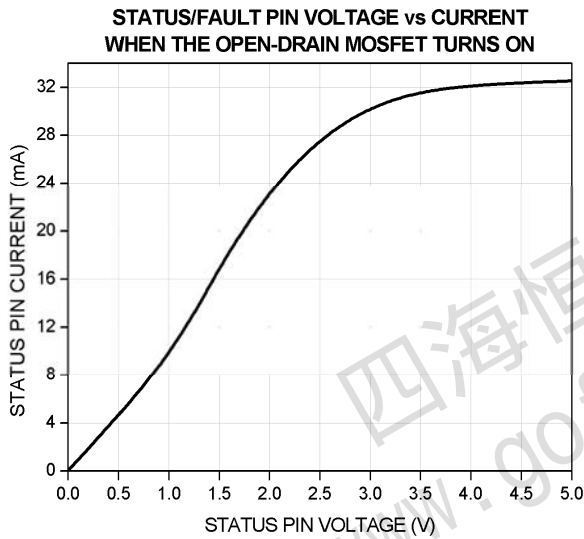
**Typical Operating Characteristics (continued)**



**Figure 16.**



**Figure 17.**



**Figure 18.**

**OPERATION**

The EUP8092 is an integrated charger for single-cell Li-ion or Li-polymer batteries. As a linear charger, the EUP8092 charges a battery in the popular constant current (CC) and constant voltage (CV) profile. The constant charge current  $I_{REF}$  is programmable up to 1.5A with an external resistor or a logic input. The charge voltage  $V_{CH}$  has 1% accuracy over the entire recommended operating condition range. A thermal-regulation feature removes the thermal concern typically seen in linear chargers. The charger reduces the charge current automatically as the IC internal temperature rises above +110°C to prevent further temperature rise. The thermal-regulation feature guarantees safe operation when the printed circuit board (PCB) is space limited for thermal dissipation.

Figure 19 shows the typical charge curves in a traditional linear charger powered with a constant-voltage adapter. From the top to bottom, the curves represent the constant input voltage, the battery voltage, the charge current and the power dissipation in the charger. The power dissipation  $P_{CH}$  is given by the following equations:

$$P_{CH} = (V_{IN} - V_{BAT}) \times I_{CHARGE} \quad (1)$$

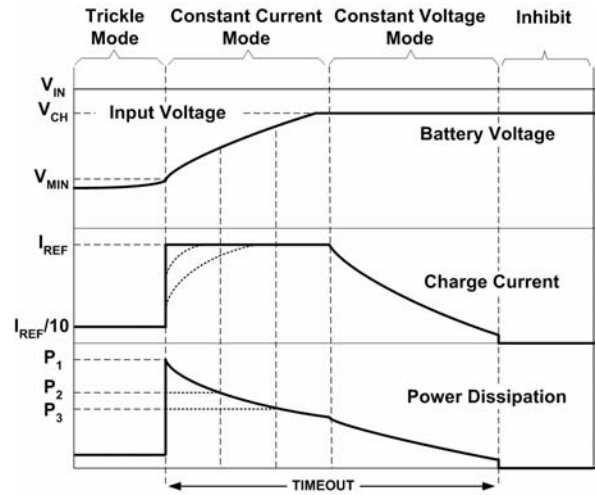
where  $I_{CHARGE}$  is the charge current. The maximum power dissipation occurs during the beginning of the CC mode. The maximum power the IC is capable of dissipating is dependent on the thermal impedance of the printed-circuit board (PCB). Figure 19 shows, with dotted lines, two cases that the charge currents are limited by the maximum power dissipation capability due to the thermal regulation.

When using a current-limited adapter, the thermal situation in the EUP8092 is totally different. Figure 19 shows the typical charge curves when a current-limited adapter is employed.

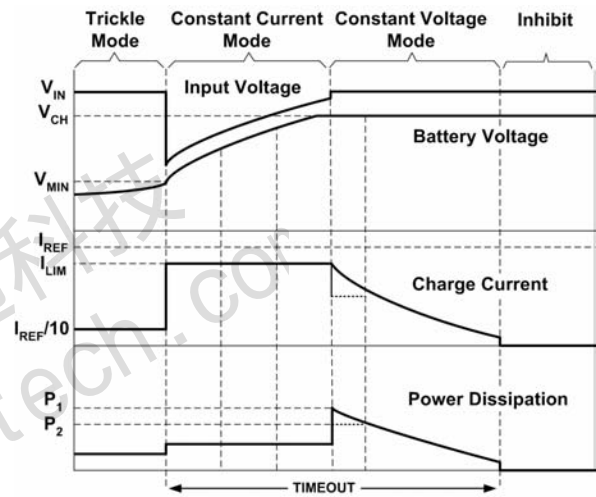
The operation requires the  $I_{REF}$  to be programmed higher than the limited current  $I_{LIM}$  of the adapter, as shown in Figure 20. The key difference of the charger operating under such conditions occurs during the CC mode. The adapter current is limited, the actual output current will never meet what is required by the current reference. Therefore, the main MOSFET becomes a power switch instead of a linear regulation device. The power dissipation in the CC mode becomes:

$$P_{CH} = R_{DS(ON)} \times I_{CHARGE}^2 \quad (2)$$

where  $R_{DS(ON)}$  is the resistance when the main MOSFET is fully turned on. This power is typically much less than the peak power in the traditional linear mode.



**Figure 19. Typical Charge Curves Using a Constant-Voltage Adapter**



**Figure 20. Typical Charge Curves Using a Current Limited Adapter**

**Battery Pre-Conditioning**

During a charge cycle if the battery voltage is below the  $V_{(MIN)}$  threshold, the EUP8092 applies a precharge current,  $I_{TRICKLE}$ , to the battery. This feature revives deeply discharged cells. The resistor connected between the  $I_{REF}$  and  $GND$ ,  $R_{IREF}$ , determines the precharge rate.

$$I_{REF} = \frac{0.8V \times 10^4}{R_{IREF}} \quad (3)$$

The EUP8092 activates a safety timer,  $I_{TRICKLE}$ , during the conditioning phase. If  $V_{MIN}$  threshold is not reached within the timer period, the EUP8092 turns off the charger and enunciates FAULT on the FAULT pins.

**Battery Charge Current**

The EUP8092 offers on-chip current regulation with programmable set point. The resistor connected between the I<sub>REF</sub> and GND, R<sub>IREF</sub>, determines the AC charge rate. There are three ways to program the charge current:

1. driving the IREF pin above 1.3V
2. driving the IREF pin below 0.35V,
3. or using the R<sub>IREF</sub> as shown in the Typical Applications.

The voltage of IREF is regulated to a 0.8V reference voltage when not driven by any external source. The charging current during the constant current mode is 100,000 times that of the current in the R<sub>IREF</sub> resistor. Hence, depending on how IREF pin is used, the charge current is,

$$I_{REF} = \begin{cases} 500\text{mA} & V_{IREF} > 1.3\text{V} \\ \frac{0.8\text{V}}{R_{IREF}} \times 10^5 (\text{A}) & R_{IREF} \\ 100\text{mA} & V_{IREF} < 0.35\text{V} \end{cases} \quad (4)$$

The 500mA current is a guaranteed maximum value for high-power USB port, with the typical value of 450mA. The 100mA current is also a guaranteed maximum value for the low-power USB port. This design accommodates the USB power specification.

**Battery Voltage Regulation**

The voltage regulation feedback is through the VBAT pin. This input is tied directly to the positive side of the battery pack. The EUP8092 monitors the battery pack voltage between the VBAT and GND pins. When the battery voltage rises to V<sub>O(REG)</sub> threshold, the voltage regulation phase begins and the charging current begins to taper down.

As a safety backup, the EUP8092 also monitors the charge time in the charge mode. If charge is not terminated within this time period, TIMEOUT, the EUP8092 turns off the charger and enunciates FAULT on the FAULT pins.

**End-of-Charge (EOC) Current**

The end-of-charge current C/10 sets the level at which the charger starts to indicate the end of the charge with the STATUS pin, as shown in Figure 21. The charger actually does not terminate charging until the end of the TIMEOUT, as described in the Total Charge Time section.

**Recharge**

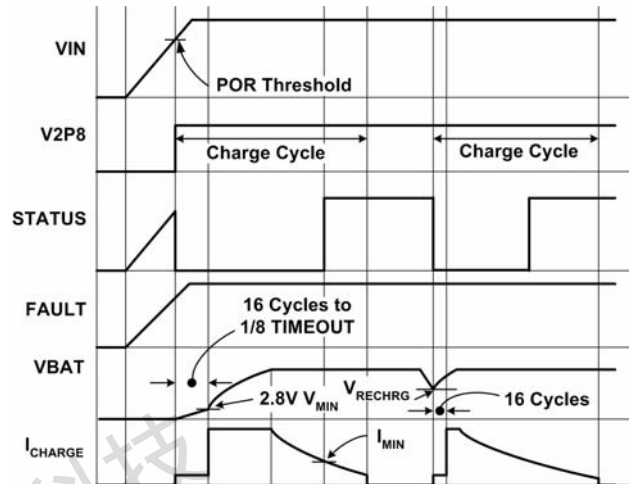
After End-of-charge, the EUP8092 re-starts the charge once the voltage on the VBAT pin falls below the V<sub>(RCH)</sub> threshold. This feature keeps the battery at full capacity at all times.

**Power on Reset (POR)**

The EUP8092 resets itself as the input voltage rises above the POR rising threshold. The V2P8 pin outputs a 2.8V voltage, the internal oscillator starts to oscillate, the internal timer is reset, and the charger begins to charge the battery.

The EUP8092 has a typical rising POR threshold of 3.4V and a falling POR threshold of 2.4V.

Signals in a charge cycle are illustrated in Figure 21.



**Figure 21. Operation Waveforms**

The following events initiate a new charge cycle:

- POR,
- a new battery being inserted (detected by TEMP pin),
- the battery voltage drops below a recharge threshold after completing a charge cycle,
- recovery from an battery over-temperature fault,
- or, the EN pin is toggled from GND to floating.

**Sleep Mode**

The EUP8092 enters the low-power sleep mode if AC-adaptor is removed from the circuit. This feature prevents draining the battery during the absence of input supply.

**Internal Timer**

The internal oscillator establishes a timing reference. The oscillation period is programmable with an external timing capacitor, C<sub>TIME</sub>. The oscillator charges the timing capacitor to 1.5V and then discharges it to 0.5V in one period, both with 10µA current. The period T<sub>OSC</sub> is:

$$T_{OSC} = 0.2 \times 10^6 \times C_{TIME} \text{ (seconds)} \quad (5)$$

A 15nF capacitor results in a 3ms oscillation period. The accuracy of the period is mainly dependent on the accuracy of the capacitance and the internal current source. The total charge time for the CC mode and CV mode is limited can be calculated as:

$$\text{TIMEOUT} = 2^{22} \times T_{\text{OSC}} = 14 \times \frac{C_{\text{TIME}}}{1\text{nF}} \text{ (minutes)} \quad (6)$$

For example, a 15nF capacitor sets the TIMEOUT to be 3.5 hours. The charger has to reach the end-of-charge condition before the TIMEOUT, otherwise, a TIMEOUT fault is issued. The TIMEOUT fault latches up the charger. There are two ways to release such a latch-up: either to recycle the input power, or toggle the EN pin to disable the charger and then enable it again.

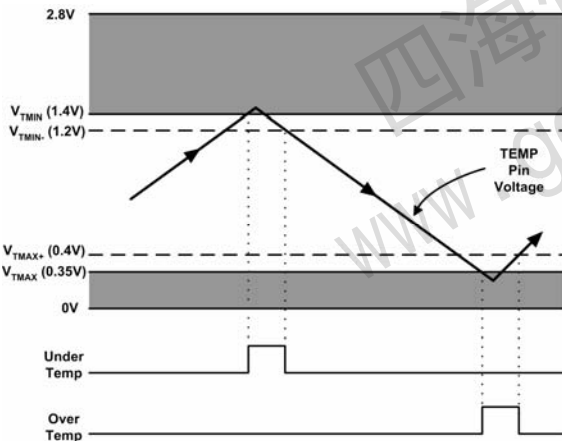
The trickle mode charge has a time limit of 1/8 TIMEOUT. If the battery voltage does not reach  $V_{\text{MIN}}$  within this limit, a TIMEOUT fault is issued and the charger latches up.

### 2.8V Bias Voltage

The EUP8092 provides a 2.8V voltage for biasing the internal control and logic circuit. This voltage is also available for external circuits such as the NTC thermistor circuit. The maximum allowed external load is 2mA.

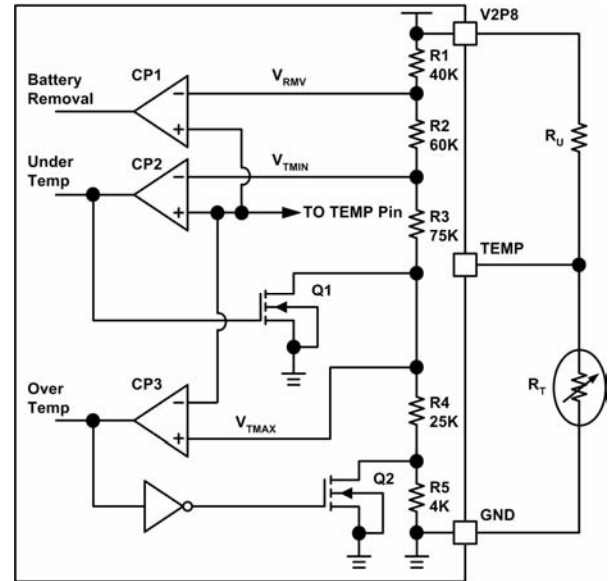
### NTC Thermistor

The EUP8092 uses two comparators (CP2 and CP3) to form a window comparator, as shown in Figure 22. When the TEMP pin voltage is “out of the window,” determined by the  $V_{\text{TMIN}}$  and  $V_{\text{TMAX}}$ , the EUP8092 stops charging and indicates a fault condition. When the temperature returns to the set range, the charger re-starts a charge cycle. The temperature window is shown in Figure 22.



**Figure 22. Critical voltage Levels for Temp Pin**

As the TEMP pin voltage rises from low and exceeds the 1.4V threshold, the under temperature signal rises and does not clear until the TEMP pin voltage falls below the 1.2V falling threshold. Similarly, the over-temperature signal is given when the TEMP pin voltage falls below the 0.35V threshold and does not clear until the voltage rises above 0.4V. The actual accuracy of the 2.8V is **not important** because all the thresholds and the TEMP pin voltage are ratios determined by the resistor dividers, as shown in Figure 23.



**Figure 23. The Internal and External circuit for The NTC Interface**

At the low temperature limit, the TEMP pin voltage is 1.4V, which is 1/2 of the 2.8V bias. Thus,

$$\frac{R_{\text{COLD}}}{R_{\text{COLD}} + R_U} = \frac{1.4}{2.8} = \frac{1}{2} \Rightarrow R_{\text{COLD}} = R_U \quad (7)$$

where  $R_U$  is the pull-up resistor as shown in Figure 23. On the other hand, at the high temperature limit the TEMP pin voltage is 0.35V, 1/8 of the 2.8V bias. Therefore,

$$\frac{R_{\text{HOT}}}{R_{\text{HOT}} + R_U} = \frac{0.35}{2.8} = \frac{1}{8} \Rightarrow R_{\text{HOT}} = \frac{R_U}{7} \quad (8)$$

For applications that do not need to monitor the battery temperature, the NTC thermistor can be replaced with a regular resistor of a half value of the pull up resistor  $R_U$ . Another option is to connect the TEMP pin to the IREF pin that has a 0.8V output. With such connection, the IREF pin can no longer be programmed with logic inputs.

### Charge Status Outputs

The open-drain  $\overline{\text{STATUS}}$  and  $\overline{\text{FAULT}}$  outputs indicate various charger operations as shown in the following table. These status pins can be used to drive LEDs or communicate to the host processor. Note that OFF indicates the open-drain transistor is turned off. Table 1 summarizes the other two pins.

**Table 1. STATUS INDICATIONS**

FAULT	STATUS	INDICATION
High	High	Charge completed with no fault (Inhibit) or Standby
High	Low	Charging in one of the three modes
Low	High	Fault

**EN Input (Charge Enable)**

The EN digital input is used to disable or enable the charge process. A high-level signal on this pin enables the charge and a low-level signal disables the charge and places the device in a low-power mode. A low-to-high transition on this pin also resets all timers and timer fault conditions.

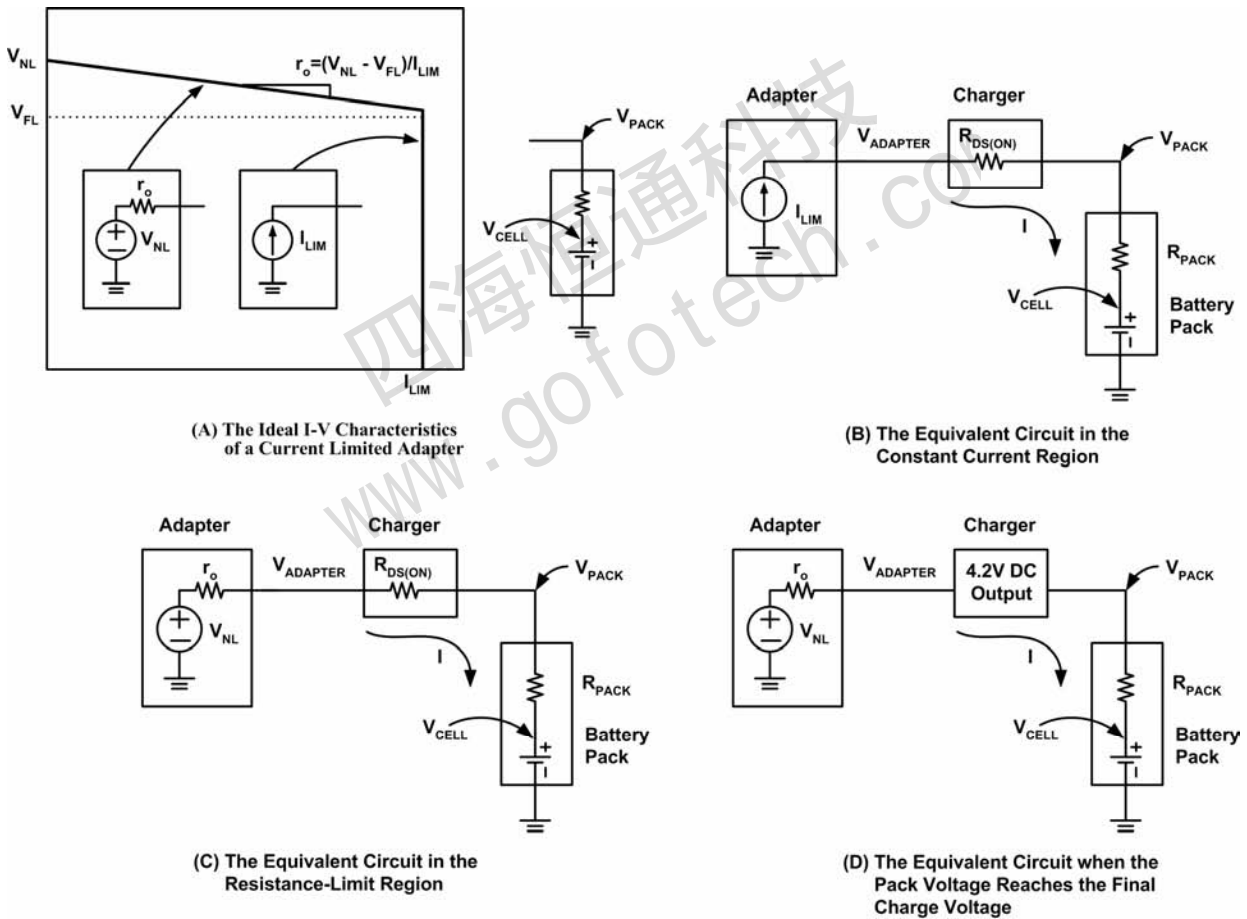
**Input and Output Capacitor Selection**

Typically any type of capacitors can be used for the input and the output. Use of a 0.47µF or higher value ceramic capacitor for the input is recommended. When the battery is attached to the charger, the output capacitor can be any ceramic type with the value higher than 0.1µF. However, if there is a chance the charger will be used as an LDO linear regulator, a 10µF tantalum capacitor is recommended.

**Current-Limited Adapter**

Figure 24 shows the ideal current-voltage characteristics of a current-limited adapter.  $V_{NL}$  is the no-load adapter output voltage and  $V_{FL}$  is the full load voltage at the current limit  $I_{LIM}$ . Before its output current reaches the limit  $I_{LIM}$ , the adapter presents the characteristics of a voltage source. The slope  $r_o$  represents the output resistance of the voltage supply. For a well regulated supply, the output resistance can be very small, but some adapters naturally have a certain amount of output resistance.

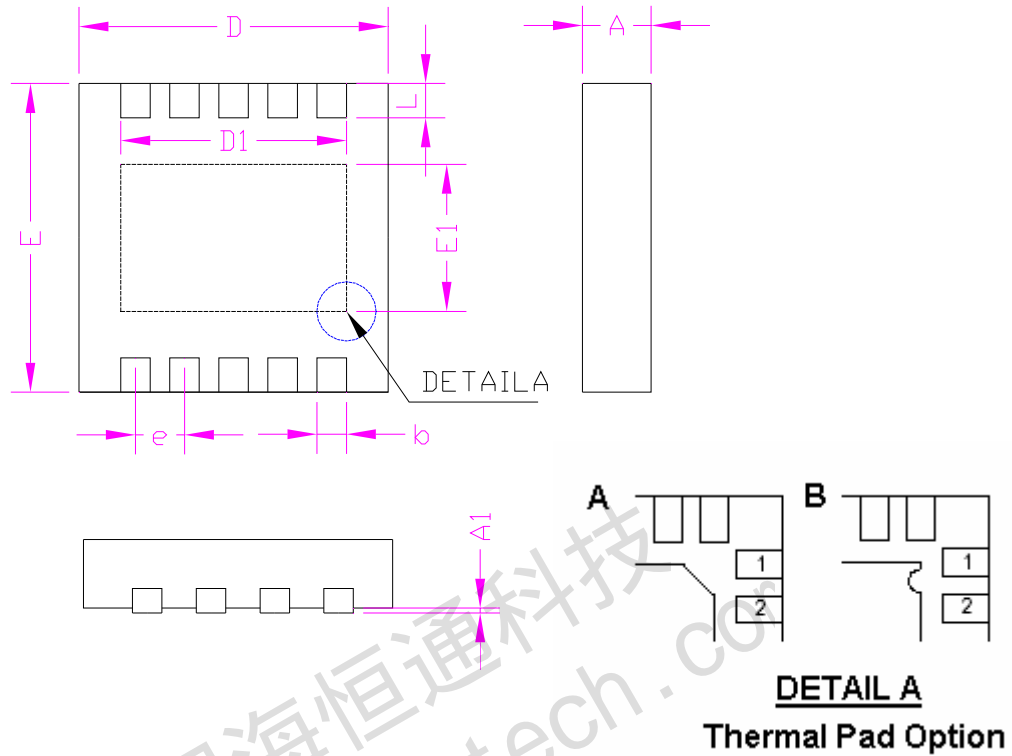
The adapter is equivalent to a current source when running in the constant-current region. Being a current source, its output voltage is dependent on the load, which, in this case, is the charger and the battery.



**Figure 24. The Equivalent Circuit of the Charging System Working with Current Limited Adapter**

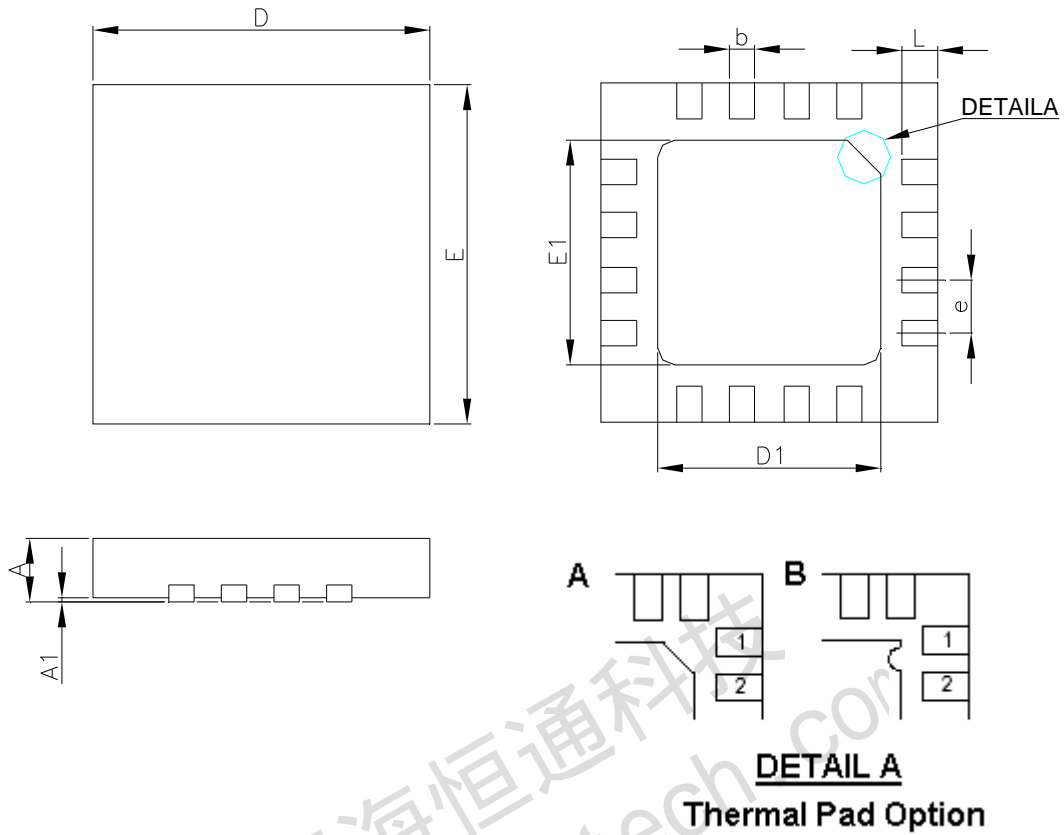
**Packaging Information**

**TDFN-10**



SYMBOLS	MILLIMETERS		INCHES	
	MIN.	MAX.	MIN.	MAX.
A	0.70	0.80	0.028	0.031
A1	0.00	0.05	0.000	0.002
D1	2.50		0.098	
D	2.90	3.10	0.114	0.122
E1	1.70		0.067	
E	2.90	3.10	0.114	0.122
L	0.30	0.50	0.012	0.020
b	0.18	0.30	0.007	0.012
e	0.50		0.020	
D1	2.40		0.094	

**TQFN-16**



SYMBOLS	MILLIMETERS		INCHES	
	MIN.	MAX.	MIN.	MAX.
A	0.70	0.80	0.028	0.031
A1	0.00	0.05	0.000	0.002
b	0.25	0.35	0.009	0.014
E	4.90	5.10	0.193	0.201
D	4.90	5.10	0.193	0.201
D1	3.20	3.60	0.126	0.142
E1	3.20	3.60	0.126	0.142
e	0.80		0.031	
L	0.30	0.55	0.012	0.022