

490 826

Lenze

Lenze
Hans-Lenze-Straße 1, D-31855 Aerzen



Global Drive

Frequency inverters
8200/9300 vector
0.37 ... 90 kW

Product selection and orders

This catalog will help you to select and order the AC drive you need quickly and easily.

It features:

- Static frequency inverters for controlling three-phase AC motors
- Accessories for assembling and connecting the inverters
- Application examples
- Order forms



Frequency inverter product information

Overview

Mains

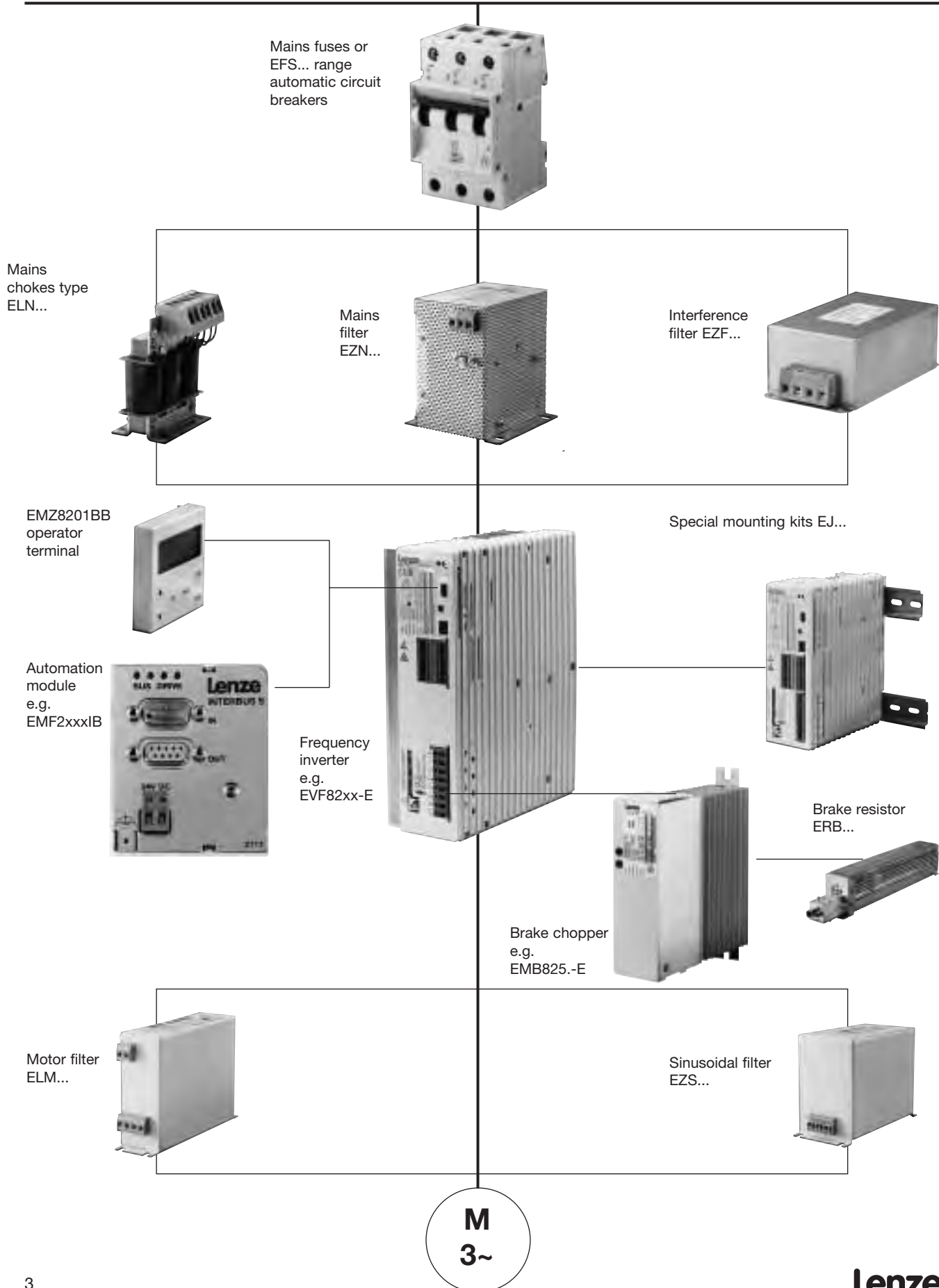

Intelligent drives in automation

Application intelligence is the feature which sets the Global Drive controller apart. When used in machines, it offers designers enormous potential for reducing costs.

Starting with the Global Drive 8200 frequency inverters for use in standard applications or HVAC and pump drives, frequently used additional automation features (e.g. PID controller) have been integrated into the device.

The freely connectable internal control structure of the servo inverters, servo register control, servo cam and 9300 servo position controller eliminates the need for numerous external I/O devices. For example, complete position control has been integrated into the 9300 servo position controller via the software. Each device type provides technology functions which are able, for example, to execute subprocesses. The additional switching elements in the system can be evaluated via the control inputs and outputs or via the system bus.

There's only one name for intelligent drives: Global Drive.



List of abbreviations

Abbreviations used in this catalog

Drive controllers

U_{mains}	[V]	Mains voltage
I_{mains}	[A]	Mains current
U_{DC}	[V]	DC bus voltage
I_r	[A]	Rated current/Output current
I_{max}	[A]	Maximum output current
P_r	[kW]	Rated motor power
S_r	[kVA]	Inverter output power
P_{loss}	[W]	Inverter power loss
f_{ch}	[kHz]	Chopper frequency
f_{max}	[Hz]	Set maximum frequency
f_d	[Hz]	Field frequency
L	[mH]	Inductance
R	[Ω]	Resistance

General

82xxE	Types 8201 to 8204E and types 8211 to 8227E
820xE	Types 8201 to 8204E
821xE	Types 8211 to 8218E (standard + Klima)
824xE	Types 8241 to 8246E (standard + Klima)
822xE	Types 8221 to 8227E (standard + Klima)
825xE	Types 8251 to 8253E
93xxEV	Types 9321EV to 9333EV
AC	Alternating current/voltage
DC	Direct current/voltage
DIN	Deutsches Institut für Normung
EMC	Electromagnetic compatibility
EN	European standard
IEC	International Electrotechnical Commission
IP	International Protection Code
NEMA	National Electrical Manufacturers Association
VDE	Verband deutscher Elektrotechniker
CE	Communauté Européene
IM	International Mounting Code

Contents

Product information

Product information 8200	8
Product information - 9300 vector	10
Design - 8200 and 9300 vector	13

Ordering data

Selecting a drive system	14
--------------------------	----

Design - 82xx

Overview of the 8200 frequency inverter	16
Overview of the 8200 klima frequency inverter	17
General data	18
8200 range ratings	19
8210 range ratings	20
8240 range ratings	24
8220 range ratings	28
Design - 8200 and 9300 vector	
Overview of the 9300 vector	32
General data	33
Ratings	34
Mechanical installation	43
General information	43
Assembly with fixing rails	44
Mounting on DIN rails	47
Assembly with thermal separation	48
Flat horizontal assembly	50
Mounting on a swivel bracket	50
Line-side electrical installation	51
Line protection	51
CE-typical installation	56
Mains chokes	58
Interference suppression to EN 55011 limiting value class A	62
Interference suppression to EN 55011 limiting value class B	62
Mains filter A for 8200 and 9300 vector	66
Mains filter B for 8200 and 9300 vector	70
Subassembly mains filters limiting value class A and B (15 kW ... 90 kW)	73
Motor-side electrical installation	75
Output filters	75
Motor filters	76
Sinusoidal filters	78
Braking	80
Options	80
Brake modules	81
Brake choppers	84
Brake resistors	86
Supply and regenerative feedback modules	88
General data	88
Mains filter A	90

DC fuses	91
DC fuses for DC-bus operation and DC power supply	91
8201BB operating module	94
9371BC operating module	95
Plug-in modules for 8200 inverters	96
System bus components for 9300 vector	98
Additional accessories	100
Setpoint potentiometer	100
Digital display	101
Communication with a host system	102
Overview of accessories for the 8200 inverter	104
Accessories for 8201 - 8204 frequency inverters	105
Accessories for 8211 - 8218 frequency inverters	106
Accessories for 8241 - 8246 frequency inverters	108
Accessories for 8221 - 8227 frequency inverters	110
Accessories for supply and regenerative feedback modules	111
Overview of accessories for the 9300 vector	112
Accessories for 9321 - 9333 frequency inverters	114

Application examples

Connecting diagrams	118
8200 range power connection	118
8210/8240/8220 range power connection	119
Connection of control terminals for the 8200 and 8210 ranges	120
Connection of control terminals for the 8240/8220 ranges	121
9300 vector range power connection	123
Connecting diagrams for 9300 vector frequency inverters	124
Applications	125
DC-bus operation	125
Pump application	127
Air conditioning system	128
Level control	129
Step control	130
Traversing control	131
Pilot frequency - Slave	132
Dancer positioning control	133

Order forms

	136
--	-----

Lenze worldwide

	144
--	-----

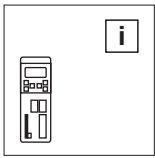

Product information 8200

A complete programme

- Frequency inverters for single-phase and three-phase mains connection
- Line-side and motor-side accessories
- Accessories for braking
- Accessories for networking with host system
- Device variants for special applications

User-friendliness

An attachable operating module with an LCD display makes it easy to set parameters for and configure your drive system. The operating module also displays the status of the drive and is used for troubleshooting as well as for transferring parameters to other devices.

Ready for immediate operation

The frequency inverters are preset for standard operation, e.g. with Lenze geared motors.

The preset parameters include:

- Maximum torque at low frequencies
- Safe start with maximum load
- Controlled acceleration and deceleration due to current limiting control
- Assignment of standard functions to inputs and outputs

Communication options

The frequency inverters communicate with a higher-level host system via attachable communication modules:

- LECOM-AB: Networking via the RS232/485 interface
- LECOM-LI: Networking via optical fibres
- INTERBUS-S: Remote bus link with DRIVECOM profile 21
- System bus (CAN): Link to I/O terminals, as well as links between a number of inverters
- PROFIBUS: Serial coupling to PROFIBUS-DP

HVAC version

The following features are amongst those required in HVAC and pump drive applications:

- PID controller
- Manual-remote changeover
- Belt monitoring

The 8200 HVAC and pump drive inverter meets these requirements.

CE conformity

The 8200 range frequency inverters meet the requirements of the following EU guidelines:

- CE conformance according to the Low-Voltage Directive
- CE conformance with the EU's EMC directive for generic drive configurations with frequency inverters

Overload capacity

Flux Torque Control (FTC) can make available up to 180% rated torque. This significantly increases the drive's torque and dynamics.

Operational reliability

An adjustable slip compensation function compensates load-dependent speed deviations without complex speed feedback. The maximum current limitation ensures stable operation at all times with static and dynamic loads.

Adaptability

The selectable form of the V/f characteristic enables the frequency inverter to be adapted to loads with constant or square-law torque. The integrated flying restart circuit enables the machine to be restarted even if the shaft is still rotating.

Optimised performance

The performance of the devices can be optimised by applying 150% or 120% overload:

- 150% overload for example for transportation systems, packaging machines, etc.
- 120% overload for example for pumps, air conditioning systems, etc.

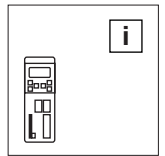

Versatility

Many different types of three-phase AC motors can be controlled:

- Three-phase asynchronous motors
- Three-phase reluctance motors
- Motors for use in hazardous areas (pressure-enclosed)
- Medium-frequency motors up to max. 480 Hz

The correct setpoint source for every application:

- Via setpoint potentiometer on the control terminals
- Via master reference voltage or master reference current on the control terminals
- Via the operating module on the frequency inverter
- Via a networking module directly from a host system

Energy-saving

The power is adapted to the drive requirements, i.e. the momentary torque and current requirements.

Space in the control cabinet

The frequency inverters are particularly compact as they can be mounted directly side by side, without the need for any clearance in between. Thanks to an extensive range of fixing accessories, they can be used in a variety of mounting positions.

Ease of controller connection

The plug-in terminal system means that all control connections can be accessed easily from outside the unit.

A Lenze geared motor – Your ideal partner

In terms of technology, Lenze geared motors are perfectly compatible with 8200 frequency inverters. Commissioning could not be easier, as the frequency inverter is configured for the motor data. There is no need to set motor data parameters. (You can find more information about Lenze geared motors in the corresponding catalog.)

Special applications? No problem.

Device variants mean that the ranges can be adapted for use in any application:

- Convection-cooled version 4.0 kW upwards

Please contact us should you require more information.

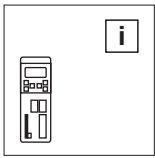

Product information - 9300 vector

A complete programme

- Frequency inverter for three-phase mains connection
- Line-side and motor-side accessories
- Accessories for braking
- Accessories for networking with host systems
- Device variants for special applications

User-friendliness

An attachable operating module with an LCD display makes it easy to set parameters for and configure your drive system. The operating module also displays the status of the drive and is used for troubleshooting as well as for transferring parameters to other devices.

Ready for immediate operation

The frequency inverters are preset for standard operation, e.g. with Lenze geared motors.

The preset parameters include:

- V/f characteristic control with adjusted slip compensation
- Controlled acceleration and deceleration due to preset current limiting control
- Assignment of standard functions to inputs and outputs

Communication options

The frequency inverters communicate with a higher-level host system via attachable communication modules:

- LECOM-AB: Networking via the RS232/485 interface
- LECOM-LI: Networking via optical fibres
- INTERBUS-S: Remote bus link with DRIVECOM profile 21
- System bus (CAN): Link to I/O terminals, as well as links between a number of inverters (integrated)
- PROFIBUS: Serial coupling to PROFIBUS-DP

CE conformity

9300 range frequency inverters meet the requirements of the following EU guidelines:

- CE conformance with the Low-Voltage Directive
- CE conformance with the EU's EMC directive for generic drive configurations with frequency inverters

Overload capacity

Vector Control can make available up to twice the rated torque.

This significantly increases the drive's torque and dynamics.

Operational reliability

Configurable slip compensation can be employed to compensate load-dependent fluctuations in speed without having to apply complex speed feedback. The maximum current limiting function ensures stable operation at every operating point for both static and dynamic loads.

Adaptability

The selectable form of the V/f characteristic enables the frequency inverter to be adapted to loads with constant or square-law torque. The integrated flying restart circuit enables the machine to be restarted even if the shaft is still rotating.

Optimised performance

The performance of the devices can be optimised by applying 150% or 120% overload:

- 150% overload for example for transportation systems, packaging machines, etc.
- 120% overload for example for pumps, air conditioning systems, etc.

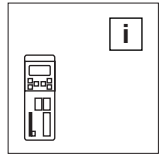

Versatility

Many different types of three-phase AC motors can be controlled:

- Three-phase asynchronous motors
- Three-phase synchronous motors
- Three-phase reluctance motors
- Motors for use in hazardous areas (pressure-enclosed)
- Medium-frequency motors up to max. 600 Hz

The correct setpoint source for every application:

- Via setpoint potentiometer on the control current on the control terminals
- Via master reference voltage or master reference current on the control terminals
- Via the operating module on the frequency inverter
- Via a networking module directly from a host system

Energy-saving

The power is adapted to the drive requirements, i.e. the momentary torque and current requirements.

Space in the control cabinet

The frequency inverters are particularly compact as they can be mounted directly side by side, without the need for any clearance in between. Thanks to an extensive range of fixing accessories, they can be used in a variety of mounting positions.

Increased functionality makes control significantly easier:

- Pilot frequency for synchronous operation using simple connectors
- Vector Control for maximum dynamics and high starting torque
- Modular, freely configurable control/function blocks which can be linked incredibly easily
- Process controller and arithmetic blocks for closed-loop and open-loop control tasks
- Integrated system bus for linking a number of controllers

Regenerative feedback modules

For energy-saving interconnected and multi-axis applications.

Ease of controller connection

The plug-in terminal system means that all control current terminals can be accessed easily from outside the unit.

A Lenze geared motor – Your ideal partner

In terms of technology, Lenze geared motors are perfectly compatible with 93xx frequency inverters. Commissioning could not be easier, as the frequency inverter is configured for the motor data. There is no need to set motor data parameters. (You can find more information about Lenze geared motors in the corresponding catalog.)

Please contact us should you require more information.

Your application ...



Extruder technology



Dosing machines



Winding technology

... solved with 8200/9300 vector frequency inverters

Design - 8200 and 9300 vector

Inverters for your application

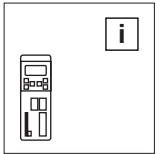

Your application	Transport and conveyor drives	Flow drives, pumps, air conditioning systems	Miniature handling equipment, beverage and snack dispensers	Extruders, dosing machines, wood processing, warehousing, etc.
Task/ Application	Few	Industrial technology functions	Small-scale applications	Complex applications
Single-phase	8201-8204 0.37 – 2.2 kW		8201-8204 with Plug-in modules 0.37 – 2.2 kW	–
Three-phase	8211-8218 8221-8227 8241-8246 0.37 – 110 kW	8211-8218 V020 8221-8227 V020 8241-8246 V020 0.37 – 110 kW	8211-8218 with plug-in modules 0.37 – 11 kW	9321-9333 Vector 0.37 – 110 kW

Compact design	●	●	●	●
Short circuit protected	●	●	●	●
FTC process	●	●	●	
Vector Control	●			
Flying restart circuit	●	●	●	●
Bipolar setpoint	●	●		
Motor potentiometer	●	●	●	●
Freely assignable inputs/outputs	●	●	●	●
Elapsed time meter	●	●	●	
Fault indication output	●	●	●	●
DC braking	●	●	●	●
Slip compensation	●	●	●	●
Skip frequencies		●	●	
PID controller		●		●
Manual/remote		●		
Belt monitoring		●		
4 parameter sets				●
Mains monitoring				●
Pilot frequency input				●
Sensorless rotational speed control				●
Modular function blocks				●
Integrated system bus				●

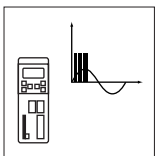

Design - 8200 and 9300 vector

Selecting a drive system

Sequence diagram

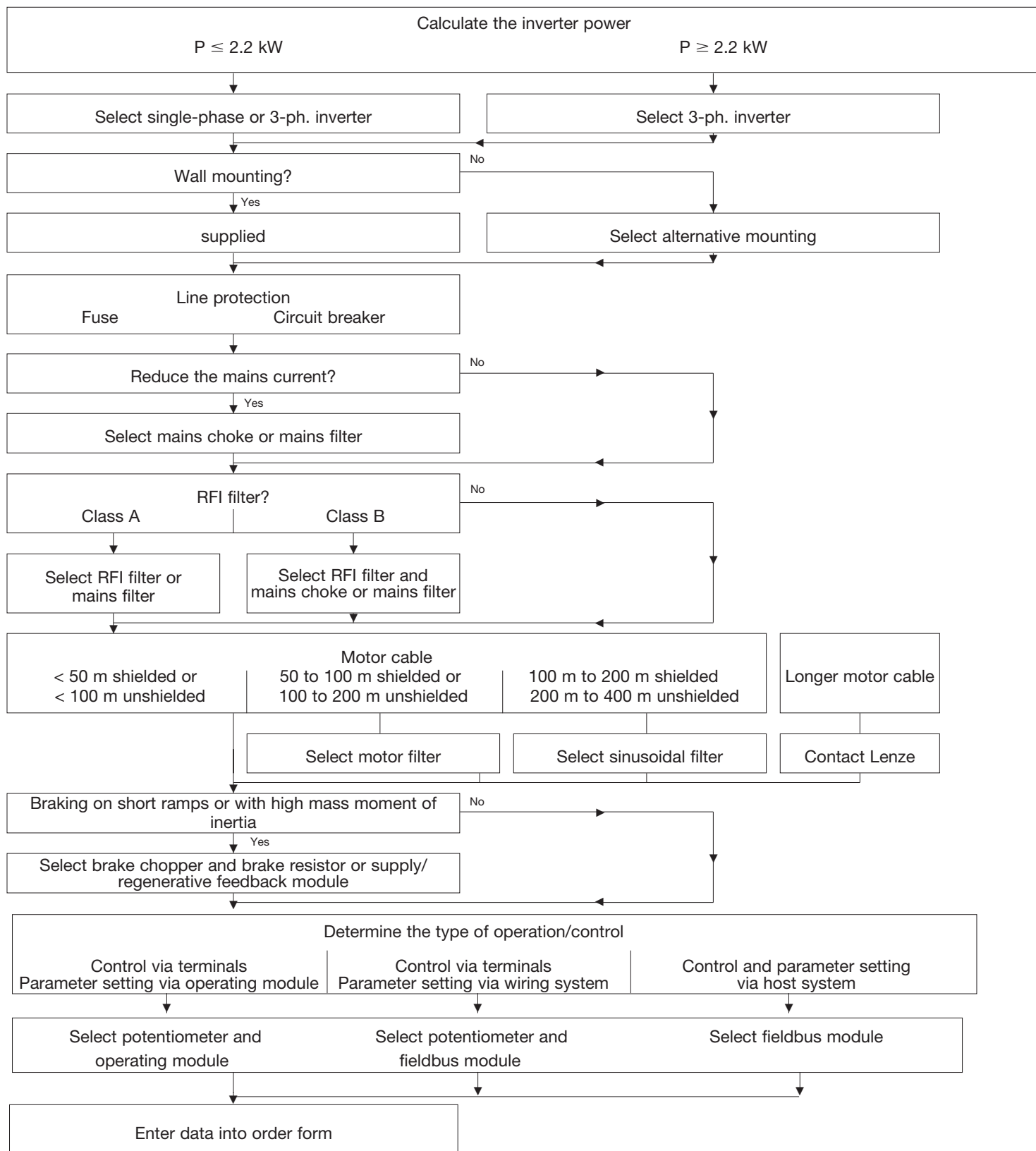

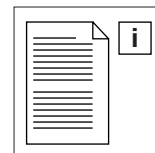

A step-by-step guide to ordering your drive

<p>The following sections of this catalog will assist you in finding a tailor-made frequency inverter for your machines. Enter your selection in the order form.</p>	
<p>⇒ This section provides extensive information</p>	<p>Example:</p>
<p>1. Select the 82XX-E device type (⇒ Design, Technical data) Select the drive controller to control the speed of the three-phase AC motor. The type of device will depend on the motor power required.</p>	<ul style="list-style-type: none"> • Inverter drive for 7.5 kW motor with 150% overload capacity <p>EVF8217-E</p>
<p>2. Select how the device is to be installed (⇒ Design, Mechanical installation) Select the accessories for installing your frequency inverter.</p>	<ul style="list-style-type: none"> • As the heat sink is installed separately, a smaller controlcabinet can be used. <p>Frame for thermal separation EJ0004</p>
<p>3. Select the line-side accessories (⇒ Design, Line-side electrical installation) Select the appropriate fuses and the accessories to ensure conformance with the limiting value classes specified if the applicable European legislation.</p>	<ul style="list-style-type: none"> • Drive location: On an industrial network • Radio interference suppression: The environmental conditions require limiting value class A to EN 55011 <p>RFI filter EZF3-025A001</p>
<p>4. Select the motor-side accessories (⇒ Design, Motor-side electrical installation) Special measures may be required for motor cables longer than 50m: Select your simple and cost-effective solution with compact motor filters or sinusoidal filters.</p>	<ul style="list-style-type: none"> • Motor cable: Length 210 m, unshielded <p>Sinusoidal filter EZS3-025A</p>
<p>5. Select additional accessories for controlling the device (⇒ Design, Additional accessories) Select useful accessories for controlling the device:</p> <ul style="list-style-type: none"> - Operating module - Automation accessories - Setpoint potentiometer. 	<ul style="list-style-type: none"> • For analog setpoint selection via master voltage or master current: Setpoint potentiometer ERPD0001k0001W Scale for potentiometer ERZ0001 Rotary button for potentiometer ERZ0002 • If you need a quick and easy device for changing the factory settings: Operating module EMZ8201BB

Our example is based on the 82xx-E frequency inverter. Follow the same procedure for the 9300 vector frequency inverter.

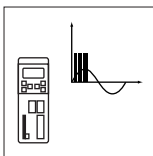

Design - 8200

Overview of the 8200 frequency inverter

Compact frequency inverter for single-phase and three-phase mains connection:

- Single-phase: 8200 range 0.37 kW - 2.2 kW
- Three-phase: 8210 range 0.75 kW - 11.0 kW
8220 range 15.0 kW - 110.0 kW
8240 range 0.37 kW - 11.0 kW

Product features

	8201-4 Single-phase 0.37 - 2.2 kW	8211-18 Three-phase 0.75 - 11.0 kW	8221-27 Three-phase 15.0-110.0 kW	8241-46 Three-phase 0.37-11.0 kW
Compact design	●	●	●	●
Load capacity for 1 min. up to 150% I _r	●	●	●	●
Inverter outputs protected against short-circuits	●	●	●	●
Earth fault check on mains disconnection	●	●	●	●
Fixed chopper frequency 9.2 kHz	●			
Variable chopper frequency 4, 8, 12 or 16 kHz	●	●	●	
V/f characteristic control with constant V _{min} boost or auto boost	●			
Motor current control or V/f characteristic control selectable (FTC technique)	●	●	●	
Mains voltage compensation	●	●	●	●
Slip compensation	●	●	●	●
Adjustable current limitation with V/f control	●	●	●	●
Pulse width modulation inverter with IGBT power stages	●	●	●	●
Connection for DC bus and brake units	●	●	●	●
Potential-free analog input and output	●	●	●	●
Relay outputs (changeover contacts)	1	1	2	2
Isolated (potential-free) digital inputs with programmable functions	4	4	4	4
Up to 3 fixed frequencies (JOG) per parameter set	●	●	●	●
DC braking	●	●	●	●
TRIP set and TRIP reset functions	●	●	●	●
Motor potentiometer	●	●	●	●
Output frequency up to 240 Hz/480 Hz	●			
Output frequency up to 480 Hz	●	●	●	
Flying restart with coasting motor	●	●	●	●
2 parameter sets	●	●	●	●
Elapsed time and running time counter	●	●	●	●
Assembly with thermal separation of power stage, 4.0 kW upwards		●	●	●

Attachable accessories				
8201BB operating module for control and parameter setting with memory for parameter transfer	●	●	●	●
Serial RS232/485 module, wire or optical fibre 2102IB	●	●	●	●
INTERBUS-S module 2111IB	●	●	●	●
PROFIBUS module 2131IB	●	●	●	●
System bus module 2171IB/2172IB	●	●	●	●
8274-78IB plug-in modules for function extension	●	●	●	●

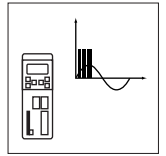

8200 klima range frequency inverters

All standard device features plus the following features for environment technology, HVAC and pump drives

	8211-18E-V020 Three-phase 0.75 -11 kW	8221-27E-V020 Three-phase 15 -110 kW	8241-46E-V020 Three-phase 0.37 -11.0 kW
Integrated PID process controller	●	●	●
Elimination of mechanical resonances	●	●	●
Load loss (V-belt) monitoring	●	●	●
Smooth start/stop along S ramps	●	●	●
Manual/automatic changeover	●	●	●
Motor phase failure detection		●	●
Mains failure detection	●	●	●
Inverse setpoint handling	●	●	●
Volume flow control without feedback	●	●	●
Speed control with feedback	●	●	●
Torque control	●	●	●
Max. possibilities for analog input signals	2	2	2
Max. possibilities for digital output signals	2	3	3
Level inversion of digital input signals	●	●	●
Priority: bus control/terminal control	●	●	●

Attachable accessories			
Analog input module 8279	●	●	●
8201BB operating module for control and parameter setting with memory for parameter transfer	●	●	●
Serial RS232/485 module, wire or optical fibre 2102IB	●	●	●
INTERBUS-S module 2111IB	●	●	●
PROFIBUS module 2131IB	●	●	●
System bus module 2171IB/2172IB	●	●	●
8274-78IB plug-in modules for function extension	●	●	●

See page 32 for details of 9300 vector frequency inverters.

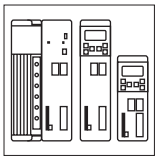

Design - 8200

General data

Range	Values															
Vibration resistance	Germanischer Lloyd, general conditions															
Humidity	Humidity class F, no condensation (average relative humidity 85%)															
Permissible temperature ranges	During device transport: - 25°C ... +70°C During device storage: - 25°C ... +55°C During device operation: 0°C ... +40°C +40°C ... +50°C with power derating 2.5% per K															
Permissible installation height h	Up to 1000 m above sea level Without power derating 1000 m above sea level ... 4000 m above sea level 5%/1000m															
Pollution degree	VDE 0110 Part 2 pollution degree 2															
Noise emission	Requirements to EN 50081-1, EN 50081-2, IEC 22G-WG4 (Cv) 21 Limiting value class A to EN 55011 (industrial area) with mains filter Limiting value class B to EN 55022 (residential area) with mains filter and control cabinet installation															
Noise immunity	Complies with limit values with mains filter Requirements to EN 50082-2, IEC 22G-WG4 (Cv) 21 <table border="0"> <thead> <tr> <th>Requirements</th> <th>Standard</th> <th>Intensity of tests</th> </tr> </thead> <tbody> <tr> <td>ESD</td> <td>EN61000-4-2</td> <td>3, i.e. 8 kV with air discharge and 6 kV with contact discharge</td> </tr> <tr> <td>HF field (housing)</td> <td>EN61000-4-3</td> <td>3, i.e. 10 V/m; 27 up to 1000 MHz</td> </tr> <tr> <td>Burst</td> <td>EN61000-4-4</td> <td>3/4, i.e. 2 kV/5 kHz</td> </tr> <tr> <td>Surge (on mains cable)</td> <td>IEC 1000-4-5</td> <td>3, i.e. 1.2/50 µs 1 kV phase-phase, 2 kV phase-PE</td> </tr> </tbody> </table>	Requirements	Standard	Intensity of tests	ESD	EN61000-4-2	3, i.e. 8 kV with air discharge and 6 kV with contact discharge	HF field (housing)	EN61000-4-3	3, i.e. 10 V/m; 27 up to 1000 MHz	Burst	EN61000-4-4	3/4, i.e. 2 kV/5 kHz	Surge (on mains cable)	IEC 1000-4-5	3, i.e. 1.2/50 µs 1 kV phase-phase, 2 kV phase-PE
Requirements	Standard	Intensity of tests														
ESD	EN61000-4-2	3, i.e. 8 kV with air discharge and 6 kV with contact discharge														
HF field (housing)	EN61000-4-3	3, i.e. 10 V/m; 27 up to 1000 MHz														
Burst	EN61000-4-4	3/4, i.e. 2 kV/5 kHz														
Surge (on mains cable)	IEC 1000-4-5	3, i.e. 1.2/50 µs 1 kV phase-phase, 2 kV phase-PE														
Insulation strength	Overvoltage category III to VDE 0110															
Packaging	To DIN 4180 - 8201 to 8218: Dust packaging - 8221 to 8227: Shipping container															
Degree of protection	IP20 NEMA 1: Protection against contact															
Approvals	CE: Low-Voltage Directive 8201 - 8218: VDE approval 8241 - 8246, 8221 - 8227: UL 508: Industrial control equipment UL 508C: Power conversion equipment															

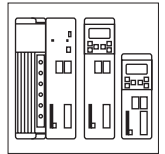

Frequency inverter for single-phase mains connection

Type		8201	8202	8203	8204
Order ref.		EVF8201-E	EVF8202-E	EVF8203-E	EVF8204-E
Order ref. compact device			EVF8202-E-V002		
Mains voltage	U_M [V]	1 / N / PE / AC / 230V / 50 Hz / 60 Hz permissible range 190...260 V \pm 0% / 45...65 Hz \pm 0%			
Alternative DC supply	U_{DC} [V]	270 V...360 V \pm 0%			
Output voltage ¹⁾		3 / PE / AC / 0... U_{mains} / 0...50 Hz , up to 240 Hz as an option			
Data for operation on mains: 1 AC / 230 V / 50 Hz / 60 Hz					
Motor power 4-pole ASM	kW	0.37	0.75	1.50	2.20
Output current	A	2.6	4.0	7.0	9.5
Max. output current 60 s	A	3.9	6.0	10.5	14.2
Output power	kVA	1.0	1.5	2.7	3.6
Mains r.m.s. current ²⁾ Without mains choke/filter With mains choke/filter	A	5.0 4.2	9.0 7.5	15.0 12.5	- 17.0
Power loss	W	30	50	70	100
Chopper frequency		Up to 9.2 kHz			
Field frequency		Resolution 50 mHz absolute Accuracy Digital setpoint preselection \pm 0.05 Hz Analog setpoint preselection - Linearity \pm 0.5% max. selected - Temperature sensitivity 0...40°C + 0.4% signal level - Offset \pm 0.3% 5 V or 10 V			
Dimensions a b e	mm	64 180 158	64 180 198 (158)	83 250 211	83 250 211
Weight Weight (compact device)	kg	1.0	1.3 1.0	2.2	2.2

1) With mains choke/filter: Max. output voltage = approx. 96% of mains voltage

2) Take the N-conductor load into account if the mains power is being distributed symmetrically on a number of inverters!

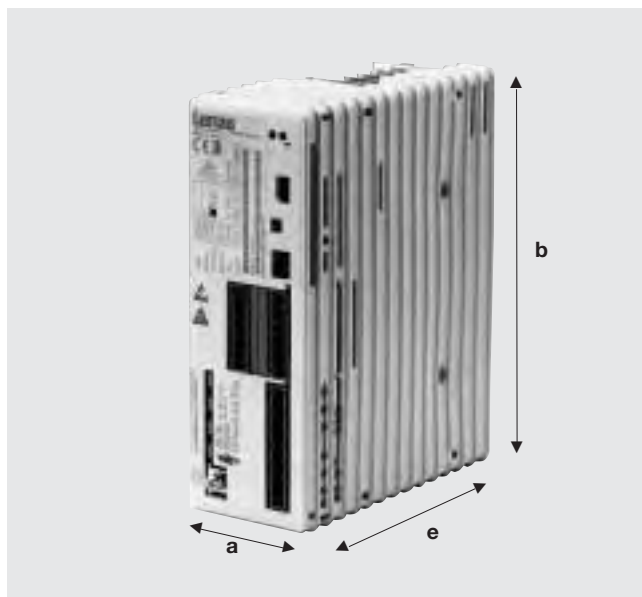

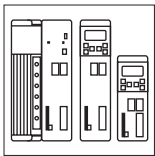

Design - 8200

Ratings

Frequency inverter for three-phase mains connection at 150% overload

Type		8211E	8212E	8213E	8214E
Order ref.		EVF8211-E	EVF8212-E	EVF8213-E	EVF8214-E
Order ref. 8200 HVAC and pump drive		EVF8211-E-V020	EVF8212-E-V020	EVF8213-E-V020	EVF8214-E-V020
Mains voltage	U_M [V]	3 / N / PE / AC / 460 V / 50 Hz / 60 Hz permissible range 320...510 V \pm 0% / 45...65 Hz \pm 0%			
Alternative DC supply	U_{DC} [V]	450 V...715 V \pm 0 %			
Output voltage ¹⁾		3 / PE / AC / 0... U_{mains} / 0...50 Hz , up to 480 Hz as an option			
Data for operation on 3 AC / 400 V / 50 Hz / 60 Hz mains					
Motor power 4-pole ASM	kW	0.75	1.5	2.2	3.0
Output current	A	2.4	3.9	5.5	7.3
Max. output current 60 s	A	3.6	5.9	8.3	11.0
Output power	kVA	1.6	2.7	3.8	5.2
Data for operation on 3 AC / 460 V / 50 Hz / 60 Hz mains					
Motor power 4-pole ASM	kW	1.1	1.5	2.2	3.7
Output current	A	2.4	3.9	5.5	7.3
Max. output current 60 s	A	3.6	5.9	8.3	11.0
Output power	kVA	1.9	3.1	4.3	5.8
Mains r.m.s. current ¹⁾ Without mains choke/filter With mains choke/filter	A	3.75 2.5	5.85 3.9	7.5 5.0	- 7.0
Power loss	W	55	75	90	100
Chopper frequency		Adjustable 4 kHz, 8 kHz , 16 kHz			
Field frequency		Resolution 20 mHz absolute Accuracy \pm 0.05 Hz Digital setpoint preselection \pm 0.05 Hz Analog setpoint preselection - Linearity \pm 0.5% Reference fmax - Temperature sensitivity 0...40°C + 0.4 % - Offset \pm 0 %			
Dimensions a b e	mm	83 250 211	83 250 211	83 250 211	83 250 211
Weight	kg	2.2	2.2	2.2	2.2

¹⁾ Data for operation with factory setting of 8 kHz chopper frequency

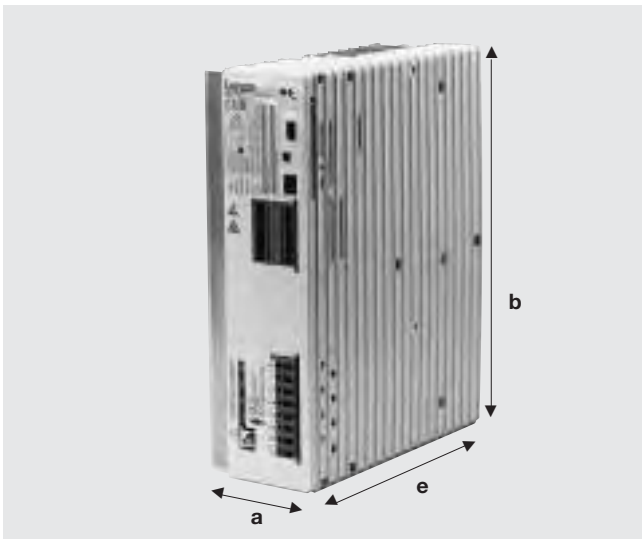

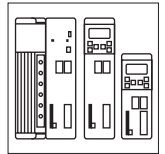

Frequency inverter for three-phase mains connection at 120% overload

Type		8211E	8212E	8213E	8214E
Order ref.		EVF8211-E	EVF8212-E	EVF8213-E	EVF8214-E
Order ref. 8200 HVAC and pump drive		EVF8211-E-V020	EVF8212-E-V020	EVF8213-E-V020	EVF8214-E-V020
Mains voltage	U_M [V]	3 / N / PE / AC / 400 V / 50 Hz / 60 Hz permissible range 320...440 V \pm 0% / 45...65 Hz \pm 0%			
Alternative DC supply	U_{DC} [V]	460 V...620 V \pm 0 %			
Output voltage ¹⁾		3 / PE / AC / 0... U_{mains} / 0...50 Hz , up to 480 Hz as an option			
Data for operation on 3 AC / 400 V / 50 Hz / 60 Hz mains					
Motor power 4-pole ASM	kW	1.1	1.5	3.0	3.0
Output current	A	3.0	3.9	7.3	7.3
Max. output current 60 s	A	3.6	5.9	11.0	11.0
Output power	kVA	2.1	2.7	5.2	5.2
Mains r.m.s. current ¹⁾ Without mains choke/filter With mains choke/filter	A	3.75 2.5	5.85 3.9	7.5 5.0	- 7.0
Power loss	W	55	75	90	100
Chopper frequency		Adjustable 4 kHz, 8 kHz , 16 kHz			
Field frequency		Resolution 20 mHz absolute Accuracy Digital setpoint preselection \pm 0.05 Hz Analog setpoint preselection - Linearity \pm 0.5% Reference fmax - Temperature sensitivity 0...40°C + 0.4% - Offset \pm 0%			
Dimensions					
a	mm	83	83	83	83
b		250	250	250	250
e		211	211	211	211
Weight	kg	2.2	2.2	2.2	2.2

¹⁾ Data for operation with factory setting of 8 kHz chopper frequency



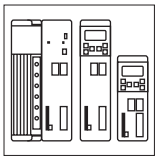

Design - 8200

Ratings

Frequency inverter for three-phase mains connection at 150% overload

Type		8215E	8216E	8217E	8218E
Order ref.		EVF8215-E	EVF8216-E	EVF8217-E	EVF8218-E
Order ref. 8200 HVAC and pump drive		EVF8215-E-V020	EVF8216-E-V020	EVF8217-E-V020	EVF8218-E-V020
Mains voltage	U_M [V]	3 / N / PE / AC / 460 V / 50 Hz / 60 Hz permissible range 320...510 V \pm 0% / 45...65 Hz \pm 0%			
Alternative DC supply	U_{DC} [V]	450 V...715 V \pm 0 %			
Output voltage ¹⁾		3 / PE / AC / 0... U_{mains} / 0...50 Hz , up to 480 Hz as an option			
Data for operation on 3 AC / 400 V / 50 Hz / 60 Hz mains					
Motor power 4-pole ASM	kW	4.0	5.5	7.5	11.0
Output current	A	9.4	13.0	16.5	23.5
Max. output current 60 s	A	14.1	19.5	24.8	35.3
Output power	kVA	6.5	9.0	11.4	16.3
Data for operation on 3 AC / 460 V / 50 Hz / 60 Hz mains					
Motor power 4-pole ASM	kW	5.5	7.5	11.0	15.0
Output current	A	9.4	13.0	16.5	23.5
Max. output current 60 s	A	14.1	19.5	24.8	35.3
Output power	kVA	7.5	10.3	13.1	18.7
Mains r.m.s. current ¹⁾ Without mains choke/filter With mains choke/filter	A	13.2 8.8	18.0 12.0	22.5 15.0	- 20.5
Power loss	W	150	200	280	400
Chopper frequency		Adjustable 4 kHz, 8 kHz , 16 kHz			
Field frequency		Resolution 20 mHz absolute Accuracy Digital setpoint preselection \pm 0.05 Hz Analog setpoint preselection - Linearity \pm 0.5% (reference fmax) - Temperature sensitivity 0...40°C + 0.4 % - Offset \pm 0 %			
Dimensions					
a	mm	125	125	125	125
b		250	250	250	250
e		218	218	218	218
Weight	kg	5.3	5.3	5.3	5.3

¹⁾ Data for operation with factory setting of 8 kHz chopper frequency

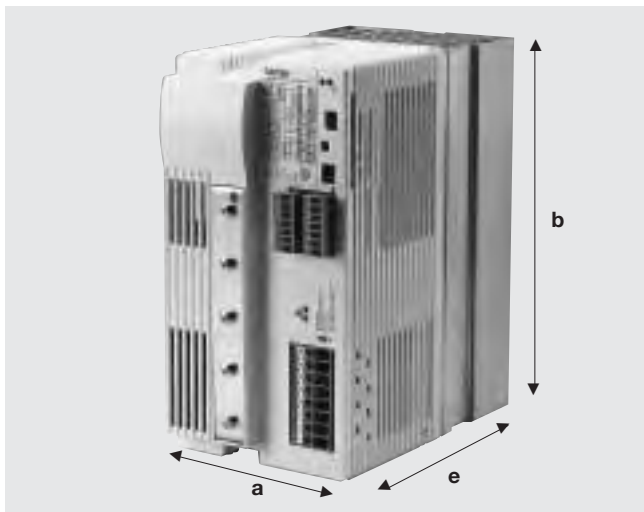

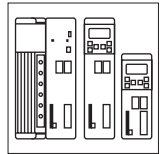

Frequency inverter for three-phase mains connection at 120% overload

Type		8215E	8216E	8217E	8218E
Order ref.		EVF8215-E	EVF8216-E	EVF8217-E	EVF8218-E
Order ref. 8200 HVAC and pump drive		EVF8215-E-V020	EVF8216-E-V020	EVF8217-E-V020	EVF8218-E-V020
Mains voltage	U_M [V]	3 / N / PE / AC / 400 V / 50 Hz / 60 Hz permissible range 320...440 V \pm 0% / 45...65 Hz \pm 0%			
Alternative DC supply	U_{DC} [V]	460 V...620 V \pm 0 %			
Output voltage ¹⁾		3 / PE / AC / 0... U_{mains} / 0...50 Hz , up to 480 Hz as an option			
Data for operation on 3 AC / 400 V / 50 Hz / 60 Hz mains					
Motor power 4-pole ASM	kW	5.5	5.5	11.0	11.0
Output current	A	13.0	13.0	23.5	23.5
Max. output current 60 s	A	14.1	19.5	24.8	35.3
Output power	kVA	9.0	9.0	16.3	16.3
Mains r.m.s. current ¹⁾ Without mains choke/filter With mains choke/filter	A	13.2 8.8	18.0 12.0	22.5 15.0	- 20.5
Power loss	W	150	200	280	400
Chopper frequency		Adjustable 4 kHz, 8 kHz , 16 kHz			
Field frequency		Resolution 20 mHz absolute Accuracy \pm 0.05 Hz Digital setpoint preselection \pm 0.05 Hz Analog setpoint preselection - Linearity \pm 0.5% (reference fmax) - Temperature sensitivity 0...40°C + 0.4 % - Offset \pm 0 %			
Dimensions a b e	mm	125 250 218	125 250 218	125 250 218	125 250 218
Weight	kg	5.3	5.3	5.3	5.3

¹⁾ Data for operation with factory setting of 8 kHz chopper frequency

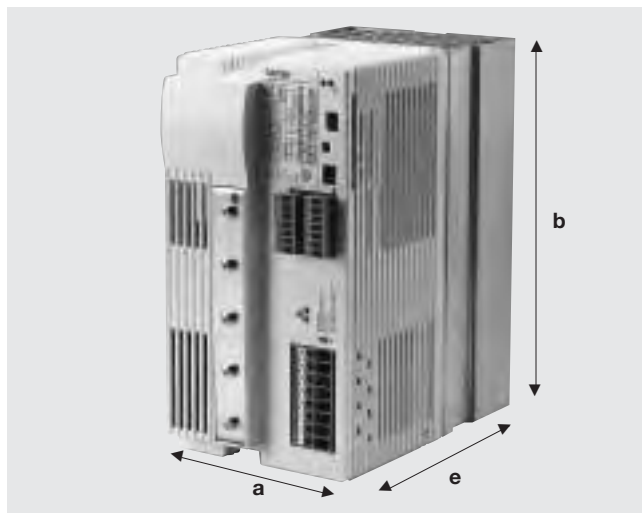

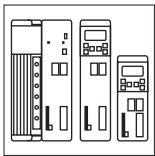

Design - 8200

Ratings

Frequency inverter for three-phase mains connection at 150% overload

Type		8241	8242	8243	8244
	Order ref.	EVF8241-E	EVF8242-E	EVF8243-E	EVF8244-E
Order ref. 8200 HVAC and pump drive		EVF8241-E-V020	EVF8242-E-V020	EVF8243-E-V020	EVF8244-E-V020
Mains voltage	U_M [V]	320 V... 528 V \pm 0% ; 45 Hz ... 65 Hz \pm 0%			
Alternative DC supply	U_{DC} [V]	460 V... 740 V \pm 0%			
Data for operation on mains: 3 AC / 400 V / 50 Hz / 60 Hz					
Motor power (4-pole ASM)	P_r [kW]	0.37	0.75	1.5	3.0
Output current	I [A]	1.5	2.5	3.9	7.0
Max. output current 60 s	I_{max} [A]	2.2	3.7	5.8	10.5
Output power	S_r [kVA]	1.0	1.7	2.7	4.8
Data for operation on mains: 3 AC / 480 V / 50 Hz / 60 Hz					
Motor power (4-pole ASM)	P_r [kW]	0.37	0.75	1.5	3.0
Output current	I [A]	1.5	2.5	3.9	7.0
Max. output current 60 s	I_{max} [A]	2.25	3.75	5.85	10.5
Output power	S_r [kVA]	1.2	2.1	3.2	5.8
Mains current	I_r [A]	1.5	2.5	3.9	7.0
Power loss	P_{loss} [W]	50	65	100	150
Chopper frequency		Adjustable 4 kHz, 8 kHz , 12 kHz, 16 kHz			
Field frequency		Resolution 20 mHz absolute Accuracy \pm 0.05 Hz Digital setpoint preselection \pm 0.5% (reference fmax) Analog setpoint preselection - Linearity \pm 0.4 % - Temperature sensitivity 0...40°C \pm 0 % - Offset \pm 0 %			
Dimensions	[mm]				
a		78 x	78 x	97 x	97 x
b		350 x	350 x	350 x	350 x
e		250	250	250	250
Weight	m [kg]	3.5	3.5	5.0	5.0

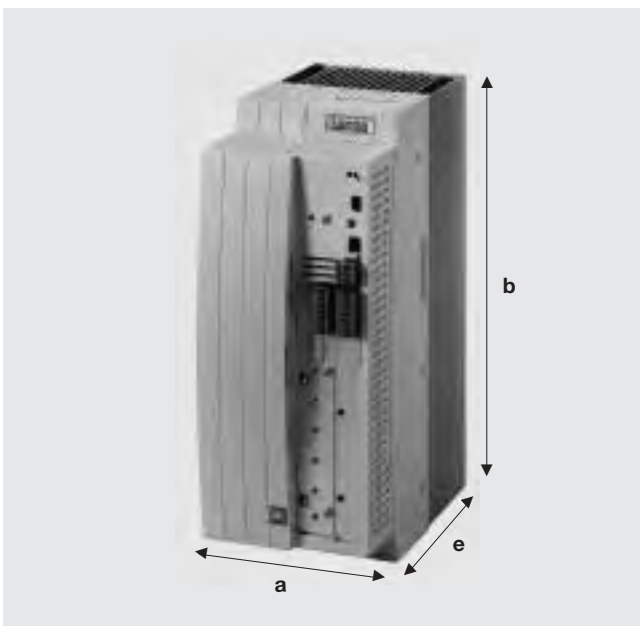

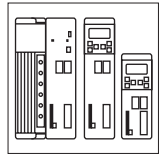

Frequency inverter for three-phase mains connection at 120% overload

Type		8241	8242	8243	8244
	Order ref.	EVF8241-E	EVF8242-E	EVF8243-E	EVF8244-E
Order ref. 8200 HVAC and pump drive		EVF8241-E-V020	EVF8242-E-V020	EVF8243-E-V020	EVF8244-E-V020
Mains voltage	U_M [V]	320 V... 440 V \pm 0% ; 45 Hz ... 65 Hz \pm 0%			
Alternative DC supply	U_{DC} [V]	460 V... 620 V \pm 0%			
Data for operation on mains: 3 AC / 400 V / 50 Hz / 60 Hz					
Motor power (4-pole ASM)	P_r [kW]	0.55	1.1	2.2	4.0
Output current	I [A]	1.8	3.0	5.5	9.4
Max. output current 60 s	I_{max} [A]	2.2	3.7	5.8	10.5
Output power	S_r [kVA]	1.3	2.1	3.8	6.5
Mains current	I_r [A]	1.5	2.5	3.9	7.0
Power loss	P_{loss} [W]	50	65	100	150
Chopper frequency		Adjustable 4 kHz, 8 kHz , 12 kHz, 16 kHz			
Field frequency		Resolution 20 mHz absolute Accuracy Digital setpoint preselection \pm 0.05 Hz Analog setpoint preselection - Linearity \pm 0.5% (reference fmax) - Temperature sensitivity 0...40°C + 0.4 % - Offset \pm 0 %			
Dimensions	[mm]				
a		78 x	78 x	97 x	97 x
b		350 x	350 x	350 x	350 x
e		250	250	250	250
Weight	m [kg]	3.5	3.5	5.0	5.0

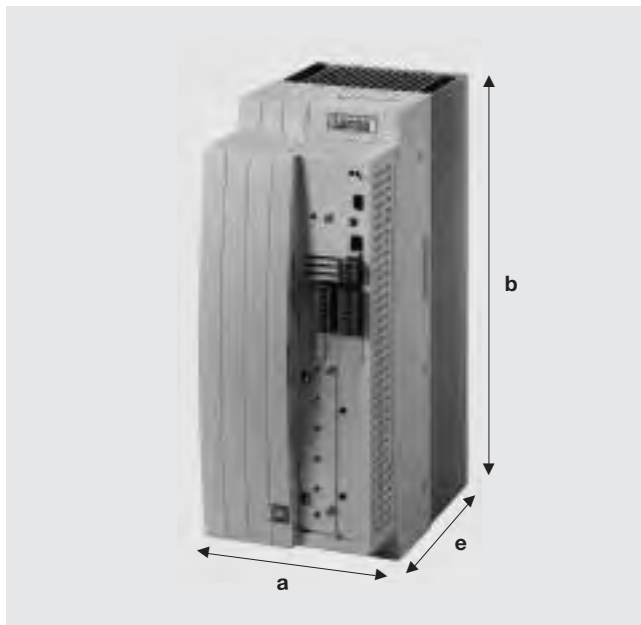

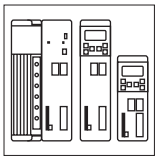

Design - 8200

Ratings

Frequency inverter for three-phase mains connection at 150% overload

Type		8245	8246		
	Order ref.	EVF8245-E	EVF8246-E		
Order ref. 8200 HVAC and pump drive		EVF8245-E-V020	EVF8246-E-V020		
Mains voltage	U_M [V]	320 V... 528 V \pm 0 % ; 45 Hz ... 65 Hz \pm 0%			
Alternative DC supply	U_{DC} [V]	460 V... 740 V \pm 0%			
Data for operation on mains: 3 AC / 400 V / 50 Hz / 60 Hz					
Motor power (4-pole ASM)	P_r [kW]	5.5	11.0		
Output current	I [A]	13.0	23.5		
Max. output current 60 s	I_{max} [A]	19.5	35.0		
Output power	S_r [kVA]	9.0	16.3		
Data for operation on mains: 3 AC / 480 V / 50 Hz / 60 Hz					
Motor power (4-pole ASM)	P_r [kW]	5.5	11.0		
Output current	I [A]	13.0	23.5		
Max. output current 60 s	I_{max} [A]	19.5	33.5		
Output power	S_r [kVA]	10.8	18.5		
Mains current	I_r [A]	12.0	20.5		
Power loss	P_{loss} [W]	210	360		
Chopper frequency		Adjustable 4 kHz, 8 kHz , 12 kHz, 16 kHz			
Field frequency		Resolution 20 mHz absolute Accuracy Digital setpoint preselection \pm 0.05 Hz Analog setpoint preselection - Linearity \pm 0.5% (reference fmax) - Temperature sensitivity 0...40°C + 0.4 % - Offset \pm 0 %			
Dimensions	[mm]				
a		135 x	135 x		
b		350 x	350 x		
e		250	250		
Weight	m [kg]	7.5	7.5		

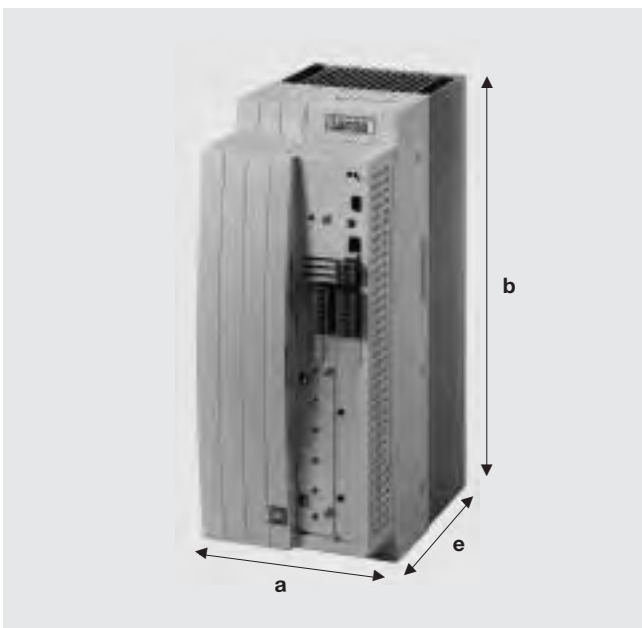

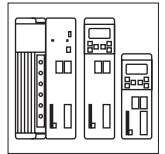

Frequency inverter for three-phase mains connection at 120% overload

Type		8245	8246		
	Order ref.	EVF8245-E	EVF8246-E		
Order ref. 8200 HVAC and pump drive		EVF8245-E-V020	EVF8246-E-V020		
Mains voltage	U_M [V]	320 V... 440 V \pm 0 % ; 45 Hz ... 65 Hz \pm 0%			
Alternative DC supply	U_{DC} [V]	460 V... 620 V \pm 0%			
Data for operation on mains: 3 AC / 400 V / 50 Hz / 60 Hz					
Motor power (4-pole ASM)	P_r [kW]	7.5	11.0		
Output current	I [A]	16.0	23.5		
Max. output current 60 s	I_{max} [A]	19.5	35.0		
Output power	S_r [kVA]	11.1	16.3		
Mains current	I_r [A]	12.0	20.5		
Power loss	P_{loss} [W]	210	360		
Chopper frequency		Adjustable 4 kHz, 8 kHz , 12 kHz, 16 kHz			
Field frequency		Resolution 20 mHz absolute Accuracy Digital setpoint preselection \pm 0.05 Hz Analog setpoint preselection - Linearity \pm 0.5% (reference fmax) - Temperature sensitivity 0...40°C + 0.4% - Offset \pm 0 %			
Dimensions	[mm]				
a		135 x	135 x		
b		350 x	350 x		
e		250	250		
Weight	m [kg]	7.5	7.5		

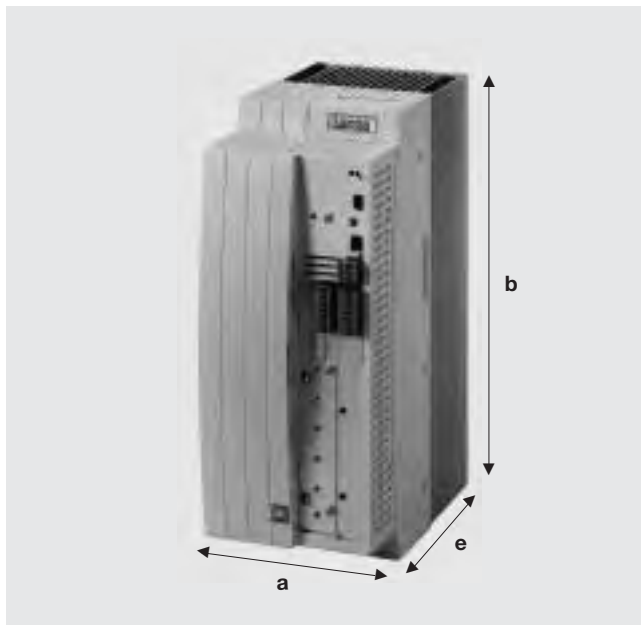

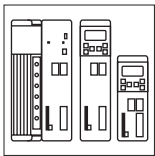

Design - 8200

Ratings

Frequency inverter for three-phase mains connection at 150% overload

Type		8221	8222	8223	8224
	Order ref.	EVF8221-E	EVF8222-E	EVF8223-E	EVF8224-E
Order ref. 8200 HVAC and pump drive		EVF8221-E-V020	EVF8222-E-V020	EVF8223-E-V020	EVF8224-E-V020
Mains voltage	U_M [V]	320 V... 528 V \pm 0% ; 45 Hz ... 65 Hz \pm 0%			
Alternative DC supply	U_{DC} [V]	460 V... 740 V \pm 0%			
Data for operation on mains: 3 AC / 400 V / 50 Hz / 60 Hz					
Motor power (4-pole ASM)	P_r [kW]	15.0	22.0	30.0	45.0
Output current	I [A]	32.0	47.0	59.0	89.0
Max. output current 60 s	I_{max} [A]	48.0	70.5	89.0	134.0
Output power	S_r [kVA]	22.2	32.6	41.6	61.7
Data for operation on mains: 3 AC / 480 V / 50 Hz / 60 Hz					
Motor power (4-pole ASM)	P_r [kW]	18.5	30.0	37.0	55.0
Output current	I [A]	32.0	47.0	56.0	84.0
Max. output current 60 s	I_{max} [A]	48.0	70.5	84.0	126.0
Output power	S_r [kVA]	26.6	39.1	49.9	73.3
Mains current	I_r [A]	29.0	42.0	55.0	80.0
Power loss	P_{loss} [W]	430	640	810	1100
Chopper frequency		Adjustable 4 kHz, 8 kHz , 12 kHz, 16 kHz			
Field frequency		Resolution 20 mHz absolute Accuracy \pm 0.05 Hz Digital setpoint preselection \pm 0.5% (reference fmax) Analog setpoint preselection - Linearity \pm 0.4 % - Temperature sensitivity 0...40°C \pm 0 % - Offset \pm 0 %			
Dimensions	[mm]				
a		250 x	250 x	250 x	340 x
b		350 x	350 x	350 x	510 x
e		250	250	250	285
Weight	m [kg]	12.5	12.5	12.5	22.0

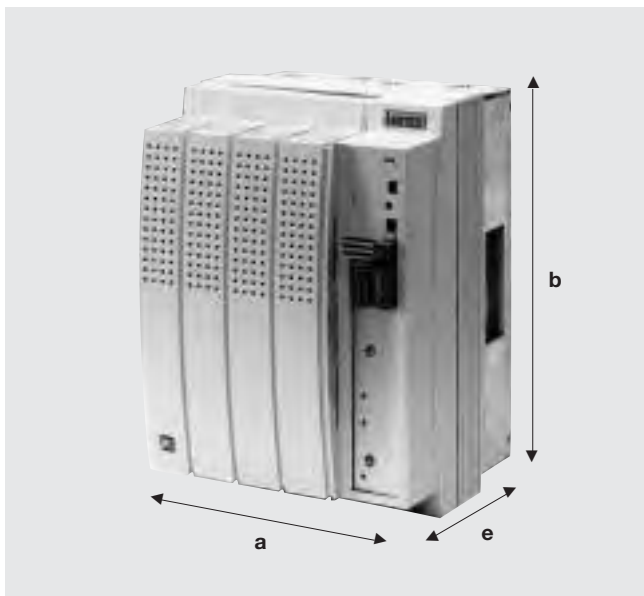

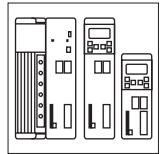

Frequency inverter for three-phase mains connection at 120% overload

Type		8221	8222	8223	8224
	Order ref.	EVF8221-E	EVF8222-E	EVF8223-E	EVF8224-E
Order ref. 8200 HVAC and pump drive		EVF8221-E-V020	EVF8222-E-V020	EVF8223-E-V020	EVF8224-E-V020
Mains voltage	U_M [V]	320 V... 440 V \pm 0% ; 45 Hz ... 65 Hz \pm 0%			
Alternative DC supply	U_{DC} [V]	460 V... 620 V \pm 0%			
Data for operation on mains: 3 AC / 400 V / 50 Hz / 60 Hz					
Motor power (4-pole ASM)	P_r [kW]	22.0	30.0	37.5	55.0
Output current	I [A]	43.0	56.0	66.0	100.0
Max. output current 60 s	I_{max} [A]	48.0	70.5	89.0	134.0
Output power	S_r [kVA]	29.8	39.5	46.4	74.8
Mains current	I_r [A]	29.0	42.0	55.0	80.0
Power loss	P_{loss} [W]	430	640	810	1100
Chopper frequency		Adjustable 4 kHz, 8 kHz , 12 kHz, 16 kHz			
Field frequency		Resolution 20 mHz absolute Accuracy Digital setpoint preselection \pm 0.05 Hz Analog setpoint preselection - Linearity \pm 0.5% (reference fmax) - Temperature sensitivity 0...40°C + 0.4 % - Offset \pm 0 %			
Dimensions	[mm]				
a		250 x	250 x	250 x	340 x
b		350 x	350 x	350 x	510 x
e		250	250	250	285
Weight	m [kg]	12.5	12.5	12.5	22.0

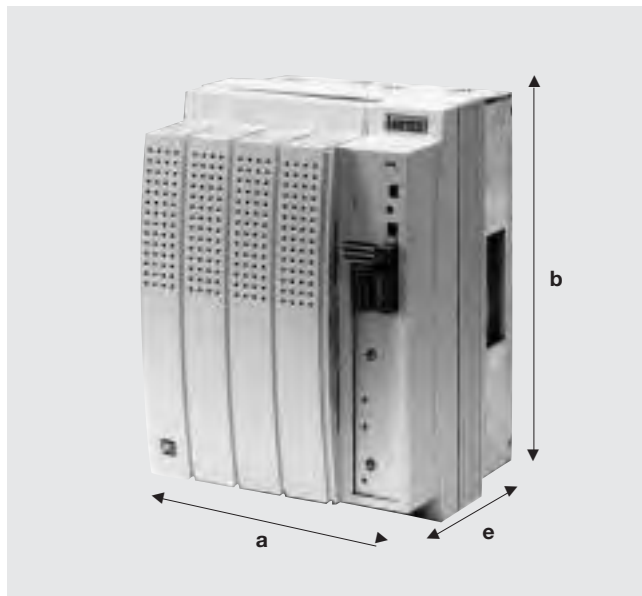

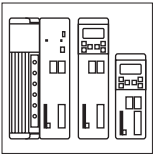

Design - 8200

Ratings

Frequency inverter for three-phase mains connection at 150% overload

Type		8225	8226	8227	
	Order ref.	EVF8225-E	EVF8226-E	EVF8227-E	
Order ref. 8200 HVAC and pump drive		EVF8225-E-V020	EVF8226-E-V020	EVF8227-E-V020	
Mains voltage	U_M [V]	320 V... 528 V \pm 0 % ; 45 Hz ... 65 Hz \pm 0%			
Alternative DC supply	U_{DC} [V]	460 V... 740 V \pm 0%			
Data for operation on mains: 3 AC / 400 V / 50 Hz / 60 Hz					
Motor power (4-pole ASM)	P_r [kW]	55.0	75.0	90.0	
Output current	I [A]	110.0	150.0	180.0	
Max. output current 60 s	I_{max} [A]	165.0	225.0	270.0	
Output power	S_r [kVA]	76.2	103.9	124.7	
Data for operation on mains: 3 AC / 480 V / 50 Hz / 60 Hz					
Motor power (4-pole ASM)	P_r [kW]	75.0	90.0	110.0	
Output current	I [A]	105.0	142.0	162.0	
Max. output current 60 s	I_{max} [A]	157.0	213.0	256.0	
Output power	S_r [kVA]	91.4	124.0	149.0	
Mains current	I_r [A]	100.0	135.0	165.0	
Power loss	P_{loss} [W]	1470	1960	2400	
Chopper frequency		Adjustable 4 kHz, 8 kHz , 12 kHz, 16 kHz			
Field frequency		Resolution 20 mHz absolute Accuracy Digital setpoint preselection \pm 0.05 Hz Analog setpoint preselection - Linearity \pm 0.5% (reference fmax) - Temperature sensitivity 0...40°C + 0.4 % - Offset \pm 0 %			
Dimensions	[mm]				
a		340 x	450 x	450 x	
b		591 x	680 x	680 x	
e		285	285	285	
Weight	m [kg]	36.5	59.0	59.0	

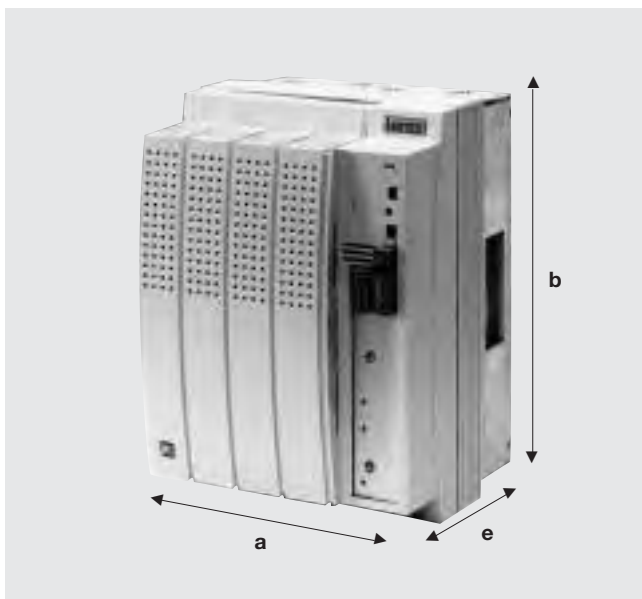

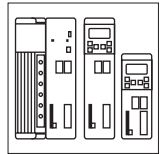

Frequency inverter for three-phase mains connection at 120% overload

Type		8225	8226	8227	
	Order ref.	EVF8225-E	EVF8226-E	EVF8227-E	
Order ref. 8200 HVAC and pump drive		EVF8225-E-V020	EVF8226-E-V020	EVF8227-E-V020	
Mains voltage	U_M [V]	320 V... 440 V \pm 0 % ; 45 Hz ... 65 Hz \pm 0%			
Alternative DC supply	U_{DC} [V]	460 V... 620 V \pm 0%			
Data for operation on mains: 3 AC / 400 V / 50 Hz / 60 Hz					
Motor power (4-pole ASM)	P_r [kW]	75.0	90.0	110.0	
Output current	I [A]	135.0	159.0	205.0	
Max. output current 60 s	I_{max} [A]	165.0	225.0	270.0	
Output power	S_r [kVA]	91.5	110.0	142.0	
Mains current	I_r [A]	100.0	135.0	165.0	
Power loss	P_{loss} [W]	1470	1960	2400	
Chopper frequency		Adjustable 4 kHz, 8 kHz , 12 kHz, 16 kHz			
Field frequency		Resolution 20 mHz absolute Accuracy Digital setpoint preselection \pm 0.05 Hz Analog setpoint preselection - Linearity \pm 0.5% (reference fmax) - Temperature sensitivity 0...40°C + 0.4 % - Offset \pm 0 %			
Dimensions	[mm]				
a		340 x	450 x	450 x	
b		591 x	680 x	680 x	
e		285	285	285	
Weight	m [kg]	36.5	59.0	59.0	

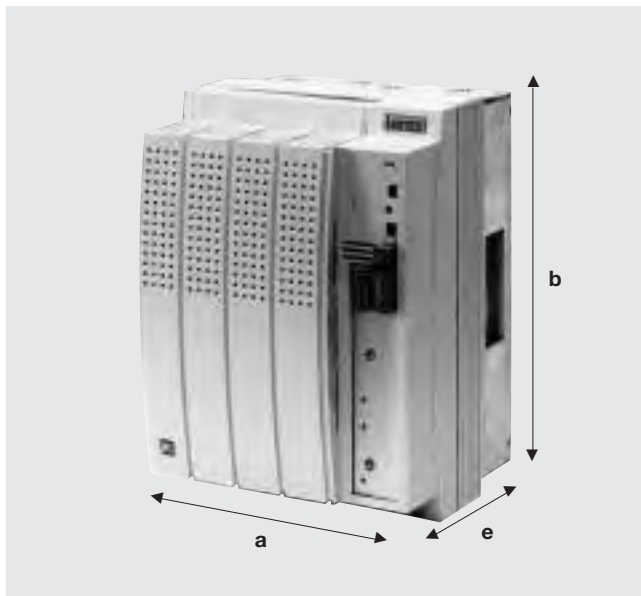

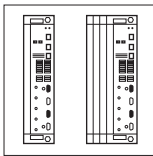

Design - 9300 vector

Overview of the 9300

Compact frequency inverter for three-phase mains connection:

- Three-phase: 9300 range 0.37 kW - 110.0 kW

Product features

	Three-phase 0.37 - 110.0 kW
Single-axis, compact design	●
For 1 min. up to 150 % overload	●
Power terminals (top)	●
Motor connections (bottom)	●
Direct connection of incremental encoder TTL 5-8 V	●
Motor phase monitoring for asynchronous motor	●
Mains monitoring	●
Vector control or V/f characteristic control	●
Sensorless speed control (vector control)	●
Digital synchronization system via pilot frequency (speed-synchronous)	●
Integrated pilot frequency input and output	●
Accessible application configurations	●
Automatic detection of motor parameters	●
Modular function blocks	●
Process controller and arithmetic blocks	●
Integrated system bus interface (CAN)	●
Flying restart with coasting motor	●
Motor potentiometer	●
Freely assignable inputs/outputs	●
4 parameter sets	●
3 skip frequencies	●
Output frequency up to 600 Hz	●
Up to 15 fixed frequencies (JOG) per parameter set	●
Chopper frequencies 2, 4, 8, 16 kHz	●

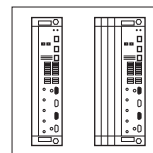

Range	Values															
Vibration resistance	Germanischer Lloyd, general conditions															
Humidity	Humidity class F, no condensation (average relative humidity 85%)															
Permissible temperature ranges	During device transport: -25 °C + 70 °C During device storage: -25 °C ... + 55 °C During device operation: 0 °C ... + 40 °C +40 °C ... + 50 °C with power derating 2.5% per K															
Permissible installation height h	Up to 1000 m above sea level 1000 m above sea level ... 4000 m above sea level	Without power derating 5%/1000m														
Pollution degree	VDE 0110 Part 2 pollution degree 2															
Noise emission	Requirements to EN 50081-1, EN 50081-2, IEC 22G-WG4 (Cv) 21 Limiting value class A to EN 55011 (industrial area) with mains filter Limiting value class B to EN 55022 (residential area) with mains filter and control cabinet installation															
Noise immunity	Complies with limit values with mains filter Requirements to EN 50082-2, IEC 22G-WG4 (Cv) 21															
	<table border="1"> <thead> <tr> <th>Requirements</th> <th>Standard</th> <th>Intensity of tests</th> </tr> </thead> <tbody> <tr> <td>ESD</td> <td>EN61000-4-2</td> <td>3, i.e. 8 kV with air discharge and 6 kV with contact discharge</td> </tr> <tr> <td>HF field (housing)</td> <td>EN61000-4-3</td> <td>3, i.e. 10 V/m; 27 up to 1000 MHz</td> </tr> <tr> <td>Burst</td> <td>EN61000-4-4</td> <td>3/4, i.e. 2 kV/5 kHz</td> </tr> <tr> <td>Surge (on mains cable)</td> <td>IEC 1000-4-5</td> <td>3, i.e. 1.2/50 μs 1 kV phase-phase, 2 kV phase-PE</td> </tr> </tbody> </table>	Requirements	Standard	Intensity of tests	ESD	EN61000-4-2	3, i.e. 8 kV with air discharge and 6 kV with contact discharge	HF field (housing)	EN61000-4-3	3, i.e. 10 V/m; 27 up to 1000 MHz	Burst	EN61000-4-4	3/4, i.e. 2 kV/5 kHz	Surge (on mains cable)	IEC 1000-4-5	3, i.e. 1.2/50 μs 1 kV phase-phase, 2 kV phase-PE
Requirements	Standard	Intensity of tests														
ESD	EN61000-4-2	3, i.e. 8 kV with air discharge and 6 kV with contact discharge														
HF field (housing)	EN61000-4-3	3, i.e. 10 V/m; 27 up to 1000 MHz														
Burst	EN61000-4-4	3/4, i.e. 2 kV/5 kHz														
Surge (on mains cable)	IEC 1000-4-5	3, i.e. 1.2/50 μs 1 kV phase-phase, 2 kV phase-PE														
Insulation strength	Overvoltage category III to VDE 0110															
Packaging	To DIN 4180 - 9321 to 9333EV: Shipping container															
Degree of protection	IP20 NEMA 1: Protection against contact															
Approvals	CE: Low voltage directive UL508: Industrial Control Equipment UL508C: Power Conversion Equipment															

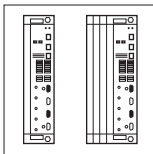

Design - 9300 vector

Ratings

Frequency inverter for three-phase mains connection at 150% overload

Type		9321	9322	9323	9324
Order ref.		EVF9321-EV	EVF9322-EV	EVF9323-EV	EVF9324-EV
Mains voltage	U_M [V]	320 V... 528 V \pm 0 % ; 45 Hz ... 65 Hz \pm 0%			
Alternative DC supply	U_{DC} [V]	460 V... 740 V +/-0%			
Data for operation on a network: 3 AC / 400 V / 50 Hz / 60 Hz					
Motor power (4-pole ASM)	P_r [kW]	0.37	0.75	1.5	3.0
Output current	I [A]	1.5	2.5	3.9	7.0
Max. output current 60 s	I_{max} [A]	2.2	3.7	5.8	10.5
Output power	S_r [kVA]	1.0	1.7	2.7	4.8
Data for operation on a network: 3 AC / 480 V / 50 Hz / 60 Hz					
Motor power (4-pole ASM)	P_r [kW]	0.37	0.75	1.5	3.0
Output current	I [A]	1.5	2.5	3.9	7.0
Max. output current 60 s	I_{max} [A]	2.2	3.7	5.8	10.5
Mains current	I_r [A]	1.5	2.5	3.9	7.0
Power loss	P_{loss} [W]	50	65	100	150
Chopper frequency	[%/K]	Adjustable 2/4 kHz, 8 kHz , 16 kHz			
Dimensions	[mm]				
a		78 x	78 x	97 x	97 x
b		350 x	350 x	350 x	350 x
e		250	250	250	250
Weight	m [kg]	4.9	4.9	5.8	6.0

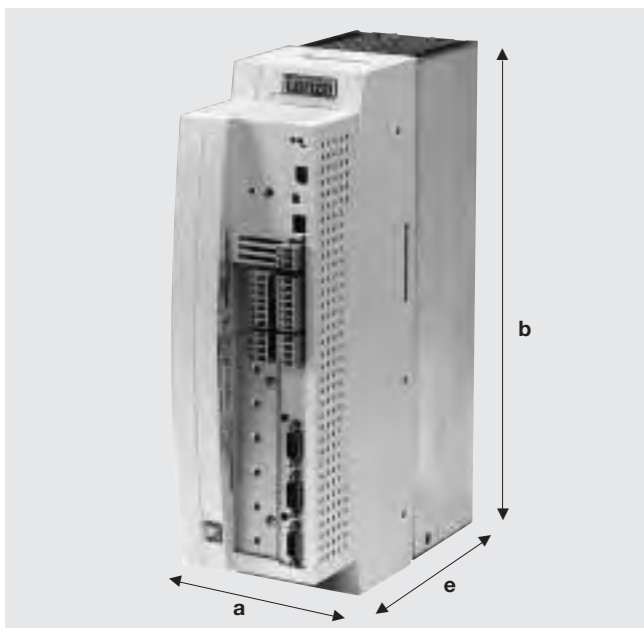

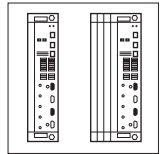

Frequency inverter for three-phase mains connection at 120% overload

Type		9321	9322	9323	9324
	Order ref.	EVF9321-EV	EVF9322-EV	EVF9323-EV	EVF9324-EV
Mains voltage	U_M [V]	320 V... 528 V \pm 0% ; 45 Hz ... 65 Hz \pm 0%			
Alternative DC supply	U_{DC} [V]	460 V... 620 V \pm 0%			
Data for operation on mains: 3 AC / 400 V / 50 Hz / 60 Hz					
Motor power (4-pole ASM)	P_r [kW]	0.55	1.1	2.2	4.0
Output current	I [A]	1.8	3.0	5.5	9.2
Max. output current 60 s	I_{max} [A]	2.2	3.7	5.8	10.5
Output power	S_r [kVA]	1.3	2.1	3.8	6.5
Mains current	I_r [A]	1.5	2.5	3.9	7.0
Power loss	P_{loss} [W]	50	65	100	150
Chopper frequency		Adjustable 2/4 kHz, 8 kHz , 16 kHz			
Dimensions	[mm]				
a		78 x	78 x	97 x	97 x
b		350 x	350 x	350 x	350 x
e		250	250	250	250
Weight	m [kg]	4.9	4.9	5.8	6.0

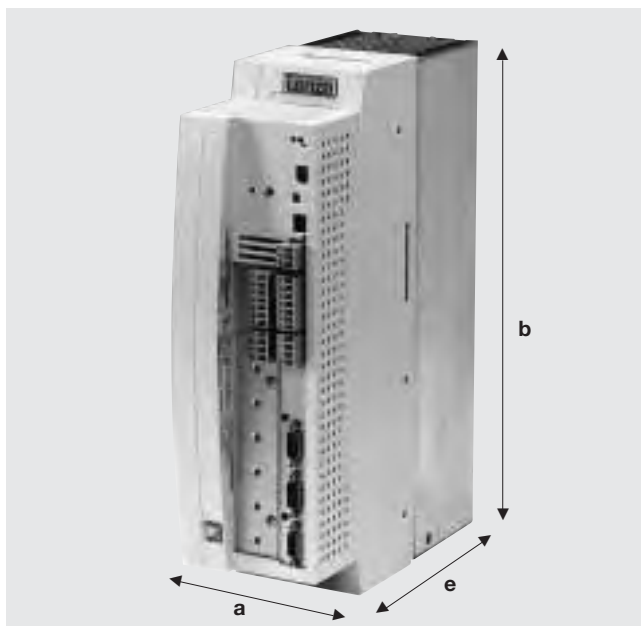

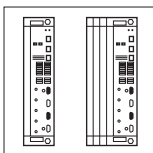

Design - 9300 vector

Ratings

Frequency inverter for three-phase mains connection at 150% overload

Type		9325	9326	
	Order ref.	EVF9325-EV	EVF9326-EV	
Mains voltage	U_M [V]	320 V... 528 V \pm 0 % ; 45 Hz ... 65 Hz \pm 0%		
Alternative DC supply	U_{DC} [V]	460 V... 740 V \pm 0%		
Data for operation on mains: 3 AC / 400 V / 50 Hz / 60 Hz				
Motor power (4-pole ASM)	P_r [kW]	5.5	11.0	
Output current	I [A]	13.0	23.5	
Max. output current 60 s	I_{max} [A]	19.5	35.0	
Output power	S_r [kVA]	9.0	16.3	
Data for operation on mains: 3 AC / 480 V / 50 Hz / 60 Hz				
Motor power (4-pole ASM)	P_r [kW]	5.5	11.0	
Output current	I [A]	13.0	22.3	
Max. output current 60 s	I_{max} [A]	19.5	33.5	
Output power	S_r [kVA]	10.8	18.5	
Mains current	I_r [A]	12.0	20.5	
Power loss	P_{loss} [W]	210	360	
Chopper frequency		Adjustable 4 kHz, 8 kHz , 16 kHz		
Dimensions	[mm]			
a		135 x	135 x	
b		350 x	350 x	
e		250	250	
Weight	m [kg]	7.8	7.8	



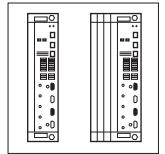

Frequency inverter for three-phase mains connection at 120% overload

Type		9325	9326		
	Order ref.	EVF9325-EV	EVF9326-EV		
Mains voltage	U_M [V]	320 V... 440 V \pm 0 % ; 45 Hz ... 65 Hz \pm 0%			
Alternative DC supply	U_{DC} [V]	460 V... 620 V \pm 0%			
Data for operation on mains: 3 AC / 400 V / 50 Hz / 60 Hz					
Motor power (4-pole ASM)	P_r [kW]	7.5	11.0		
Output current	I [A]	15.0	23.5		
Max. output current 60 s	I_{max} [A]	19.5	35.0		
Output power	S_r [kVA]	11.1	16.3		
Mains current	I_r [A]	12.0	20.5		
Power loss	P_{loss} [W]	210	360		
Chopper frequency		Adjustable 2 kHz, 4 kHz, 8 kHz , 12 kHz, 16 kHz			
Dimensions	[mm]				
a		135 x	135 x		
b		350 x	350 x		
e		250	250		
Weight	m [kg]	7.8	7.8		

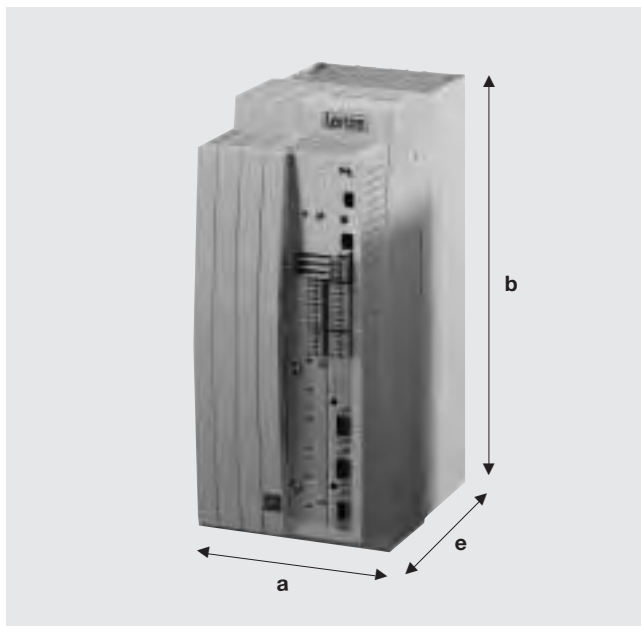

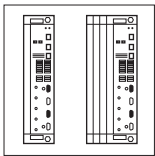

Design - 9300 vector

Ratings

Frequency inverter for three-phase mains connection at 150% overload

Type		9327	9328	9329	9330
	Order ref.	EVF9327-EV	EVF9328-EV	EVF9329-EV	EVF9330-EV
Mains voltage	U_M [V]	320 V... 528 V \pm 0% ; 45 Hz ... 65 Hz \pm 0%			
Alternative DC supply	U_{DC} [V]	460 V... 740 V \pm 0%			
Data for operation on mains: 3 AC / 400 V / 50 Hz / 60 Hz					
Motor power (4-pole ASM)	P_r [kW]	15.0	22.0	30.0	45.0
Output current	I [A]	32.0	47.0	59.0	89.0
Max. output current 60 s	I_{max} [A]	48.0	70.5	88.5	134.0
Output power	S_r [kVA]	22.2	32.6	41.6	61.7
Data for operation on mains: 3 AC / 480 V / 50 Hz / 60 Hz					
Motor power (4-pole ASM)	P_r [kW]	18.5	30.0	37.0	55.0
Output current	I [A]	30.4	44.7	56.0	84.0
Max. output current 60 s	I_{max} [A]	45.6	67.0	84.0	126.0
Output power	S_r [kVA]	26.6	39.1	49.9	73.3
Mains current	I_r [A]	29.0	42.0	55.0	80.0
Power loss	P_{loss} [W]	430	640	810	1100
Chopper frequency		Adjustable 2 kHz, 4 kHz, 8 kHz , 12 kHz, 16 kHz			
Dimensions	[mm]				
a		250 x	250 x	250 x	340 x
b		350 x	350 x	350 x	510 x
e		250	250	250	285
Weight	m [kg]	18.0	18.0	18.0	36.0

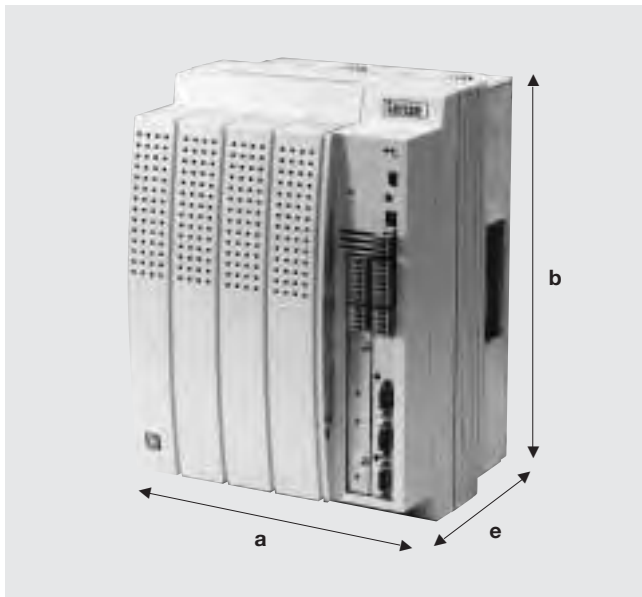

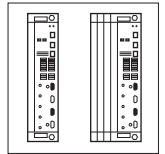

Frequency inverter for three-phase mains connection at 120% overload

Type		9327	9328	9329	9330
	Order ref.	EVF9327-EV	EVF9328-EV	EVF9329-EV	EVF9330-EV
Mains voltage	U_M [V]	320 V... 440 V \pm 0% ; 45 Hz ... 65 Hz \pm 0%			
Alternative DC supply	U_{DC} [V]	460 V... 620 V \pm 0%			
Data for operation on mains: 3 AC / 400 V / 50 Hz / 60 Hz					
Motor power (4-pole ASM)	P_r [kW]	22.0	30.0	37.5	55.0
Output current	I [A]	43.0	56.0	66.0	100
Max. output current 60 s	I_{max} [A]	48.0	70.5	88.5	134.0
Output power	S_r [kVA]	29.8	39.5	46.4	74.8
Mains current	I_r [A]	29.0	42.0	55.0	80.0
Power loss	P_{loss} [W]	430	640	810	1100
Chopper frequency		Adjustable 2 kHz, 4 kHz, 8 kHz , 16 kHz			
Dimensions	[mm]				
a		250 x	250 x	250 x	340 x
b		350 x	350 x	350 x	510 x
e		250	250	250	285
Weight	m [kg]	18.0	18.0	18.0	36.0

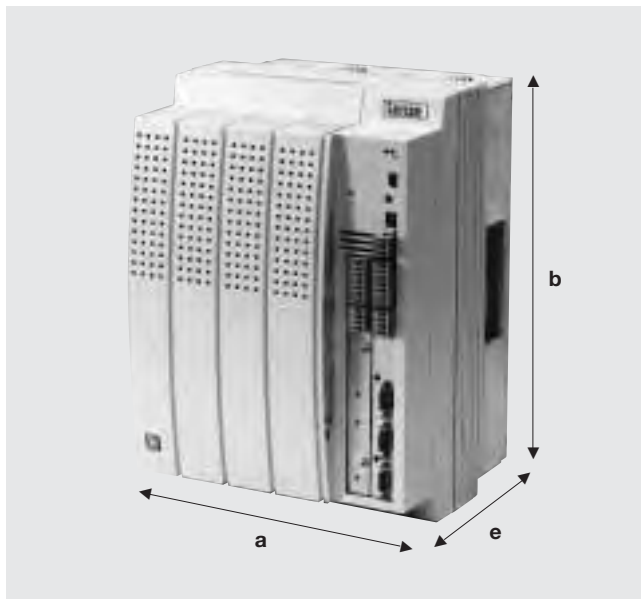

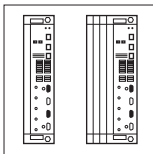

Design - 9300 vector

Ratings

Frequency inverter for three-phase mains connection at 150% overload

Type		9331	9332	9333	
	Order ref.	EVF9331-E	EVF9332-E	EVF9333-E	
Mains voltage	U_M [V]	320 V... 528 V \pm 0 % ; 45 Hz ... 65 Hz \pm 0%			
Alternative DC supply	U_{DC} [V]	460 V... 740 V \pm 0%			
Data for operation on mains: 3 AC / 400 V / 50 Hz / 60 Hz					
Motor power (4-pole ASM)	P_r [kW]	55.0	75.0	90.0	
Output current	I [A]	110.0	150.0	180.0	
Max. output current 60 s	I_{max} [A]	165.0	225.0	270.0	
Output power	S_r [kVA]	76.2	103.9	124.7	
Data for operation on mains: 3 AC / 480 V / 50 Hz / 60 Hz					
Motor power (4-pole ASM)	P_r [kW]	75.0	90.0	110.0	
Output current	I [A]	105.0	142.0	171.0	
Max. output current 60 s	I_{max} [A]	157.0	213.0	256.0	
Output power	S_r [kVA]	91.4	124.0	149.0	
Mains current	I_r [A]	100.0	135.0	165.0	
Power loss	P_{loss} [W]	1470	1960	2400	
Chopper frequency		Adjustable 2 kHz, 4 kHz, 8 kHz , 16 kHz			
Dimensions	[mm]				
a		340 x	450 x	450 x	
b		591 x	680 x	680 x	
e		285	285	285	
Weight	m [kg]	38.0	70.0	70.0	

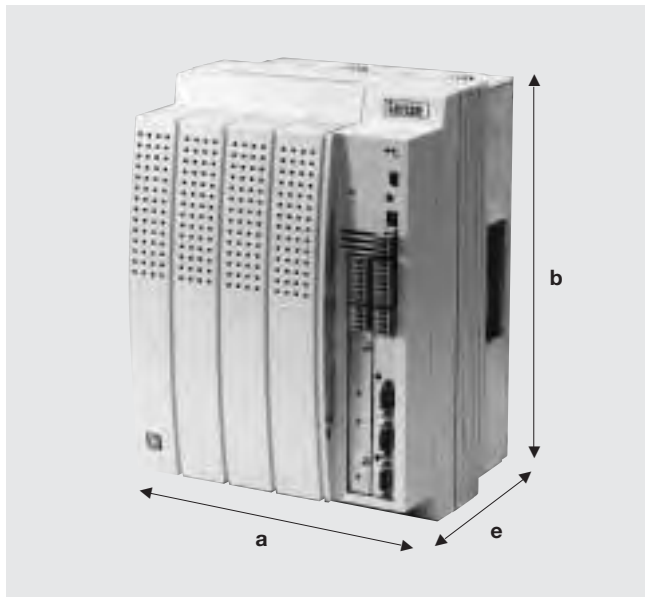

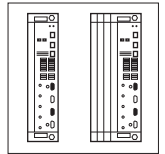

Frequency inverter for three-phase mains connection at 120% overload

Type		9331	9332	9333	
	Order ref.	EVF9331-EV	EVF9332-EV	EVF9333-EV	
Mains voltage	U_M [V]	320 V... 440 V \pm 0 % ; 45 Hz ... 65 Hz \pm 0%			
Alternative DC supply	U_{DC} [V]	460 V... 620 V \pm 0%			
Data for operation on mains: 3 AC / 400 V / 50 Hz / 60 Hz					
Motor power (4-pole ASM)	P_r [kW]	75.0	90.0	110.0	
Output current	I [A]	135.0	159.0	205.0	
Max. output current 60 s	I_{max} [A]	165.0	225.0	270.0	
Output power	S_r [kVA]	91.5	110.0	142.0	
Mains current	I_r [A]	100.0	135.0	165.0	
Power loss	P_{loss} [W]	1470	1960	2400	
Chopper frequency		Adjustable 2 kHz, 4 kHz, 8 kHz , 16 kHz			
Dimensions	[mm]				
a		340 x	450 x	450 x	
b		591 x	680 x	680 x	
e		285	285	285	
Weight	m [kg]	38.0	70.0	70.0	

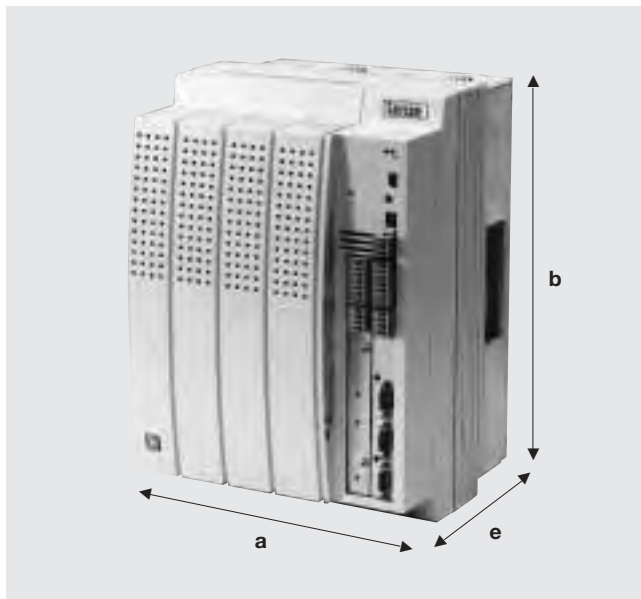

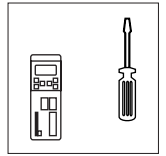

General information

- 8200 vector frequency inverters must only be used as built-in units.
- If the exhaust air contains pollutants (dust, lint, grease, aggressive gases) then appropriate counter-measures must be in place (e.g. installation of filters, regular cleaning etc.).
- Ensure there is enough mounting space.
Several units can be mounted directly adjacent to one another without clearance.
Ensure that there is free access for cooling air and that the outlet for used air is not blocked.
Ensure clearance of 100 mm above and below.
- In the event of continuous oscillations or vibrations, check the use of vibration dampers.

The frequency inverters can be fitted as follows into a control cabinet:

- With the **fixing rails** included in the scope of supply
- With a **DIN rail mounting up to 3.0 kW**
- With **thermal separation from 4.0 kW upwards**
- With special **fixing devices**

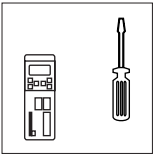

Design - 8200 and 9300 vector

Assembly with fixing rail

The devices are supplied with a mounting rail (8201-18, 8241-46, 9321-26) or mounting clamps (8221-27, 9327-33).

These can be used to fix the frequency inverter to the back panel of the control cabinet or to the mounting plate. The mounting rail is fixed to the device in a guideway,

providing access to fixing clamps from above and below. 8221-27 devices are installed with 4 lateral fixing clamps.

A DIN rail assembly is also available for 8201-8214 devices and thermal separation is possible on 8215-8227 and 9321-33 devices.

Figure A

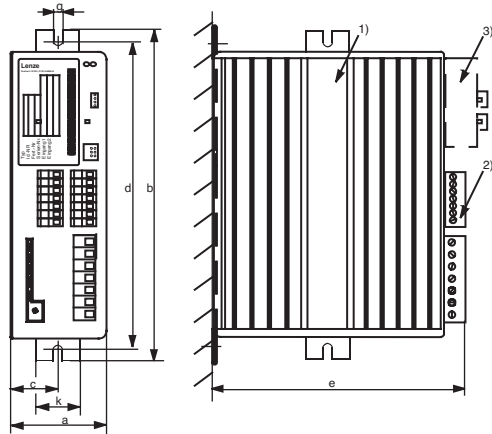

Figure B

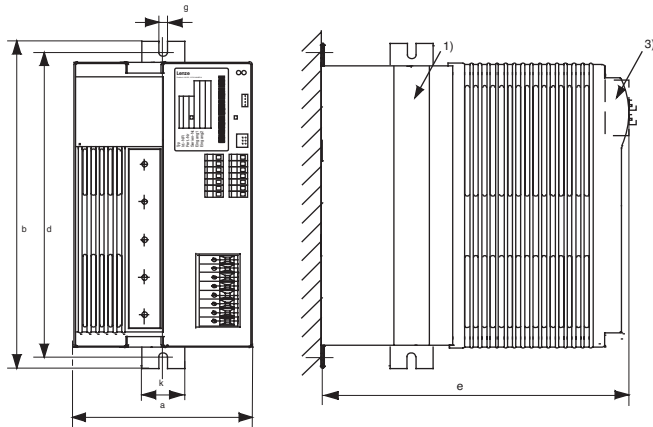
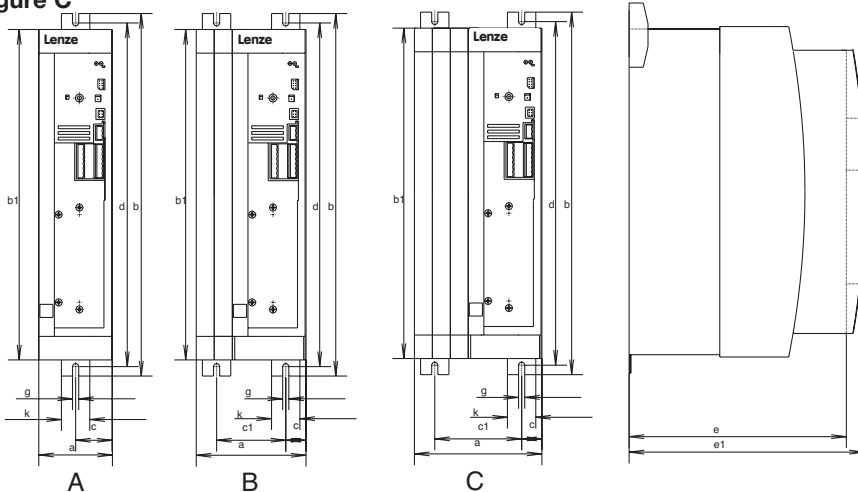
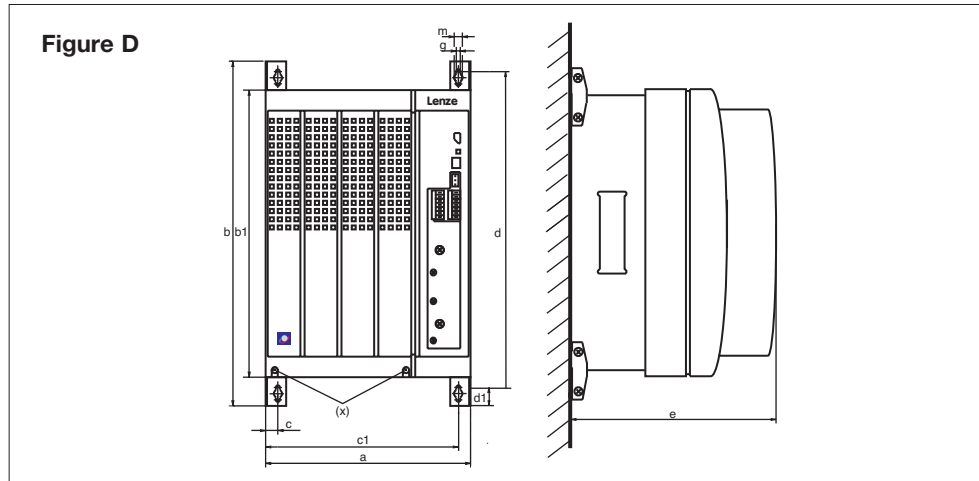
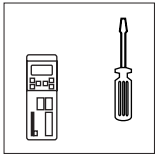

Figure C





Device	Figure	a [mm]	b [mm]	b1 [mm]	c [mm]	c1 [mm]	d [mm]	d1 [mm]	e [mm]	g [mm]	k [mm]	m [mm]
8201E	A	64	210	-	29	-	190	-	158	6.5	30	-
8202E	A	64	210	-	29	-	190	-	198	6.5	30	-
8202E-V002	A	64	210	-	29	-	190	-	158	6.5	30	-
8203E	A	83	283	-	38	-	263	-	211	6.5	30	-
8204E	A	83	283	-	38	-	263	-	211	6.5	30	-
8211E	A	83	283	-	38	-	263	-	211	6.5	30	-
8212E	A	83	283	-	38	-	263	-	211	6.5	30	-
8213E	A	83	283	-	38	-	263	-	211	6.5	30	-
8214E	A	83	283	-	38	-	263	-	211	6.5	30	-
8215E	B	125	283	-	-	-	263	-	218	6.5	30	-
8216E	B	125	283	-	-	-	263	-	218	6.5	30	-
8217E	B	125	283	-	-	-	263	-	218	6.5	30	-
8218E	B	125	283	-	-	-	263	-	218	6.5	30	-
8241E/9321EV	C	78	384	350	39	-	365	-	250	6.5	30	-
8242E/9322EV	C	78	384	350	39	-	365	-	250	6.5	30	-
8243E/9323EV	C	97	384	350	48.5	-	365	-	250	6.5	30	-
8244E/9324EV	C	97	384	350	48.5	-	365	-	250	6.5	30	-
8245E/9325EV	C	135	384	350	21.5	92	365	-	250	6.5	30	-
8246E/9326EV	C	135	384	350	21.5	92	365	-	250	6.5	30	-
8221E/9327EV	D	250	402	350	22	205	370	24	250	6.5	-	11.0
8222E/9328EV	D	250	402	350	22	205	370	24	250	6.5	-	11.0
8223E/9329EV	D	250	402	350	22	205	370	24	250	6.5	-	11.0
8224E/9330EV	D	340	580	510	28	284	532	38	285	11.0	-	18.0
8225E/9331EV	D	340	672	591	28	284	624	38	285	11.0	-	18.0
8226E/9332EV	D	450	750	680	30.5	395	702	38	285	11.0	-	18.0
8227E/9333EV	D	450	750	680	30.5	395	702	38	285	11.0	-	18.0

Design - 8200 and 9300 vector

Mounting with DIN rail assembly

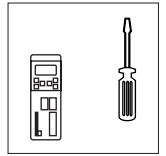

A special bracket can be used to fix 8201-8214 devices to two DIN rails (H1, H2).

8201/02 devices can also be fixed with one DIN rail (H3). Alternatively, the controller can be installed using a fixing rail.

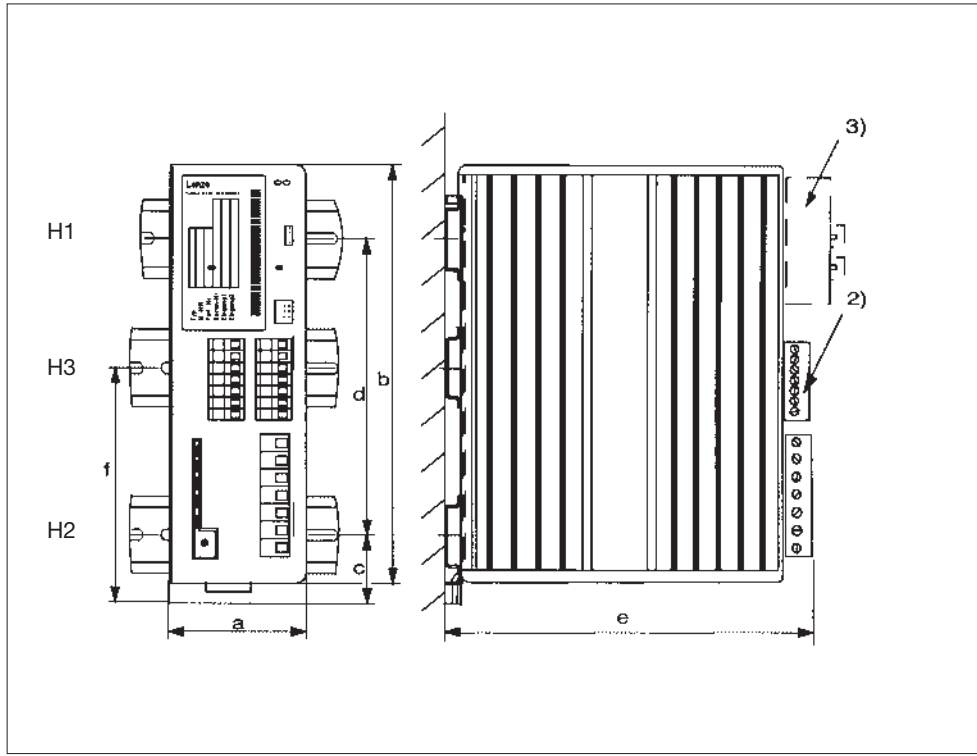

Device	a [mm]	b [mm]	c [mm]	d [mm]	e [mm]	f [mm]
8201E	64	180	16	125	173	98
8202E	64	180	16	125	213	98
8203E	83	250	16	125	237	-
8204E	83	250	16	125	237	-
8211E	83	250	16	125	226	-
8212E	83	250	16	125	226	-
8213E	83	250	16	125	226	-
8214E	83	250	16	125	226	-

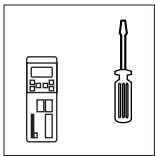

Design - 8200 and 9300 vector

Assembly with thermal separation (push-through technology)

Thermal separation is required in some applications. It significantly reduces heat generation inside the control cabinet.

8215-8227/9321-9333 frequency inverters can be set up so that the heat sink remains outside the control cabinet. You will need an assembly frame and a seal.

- Distribution of power loss:
 - Approx. 65% via separate cooler (heat sink and fan)
 - Approx. 35% inside the device
- The device ratings continue to apply

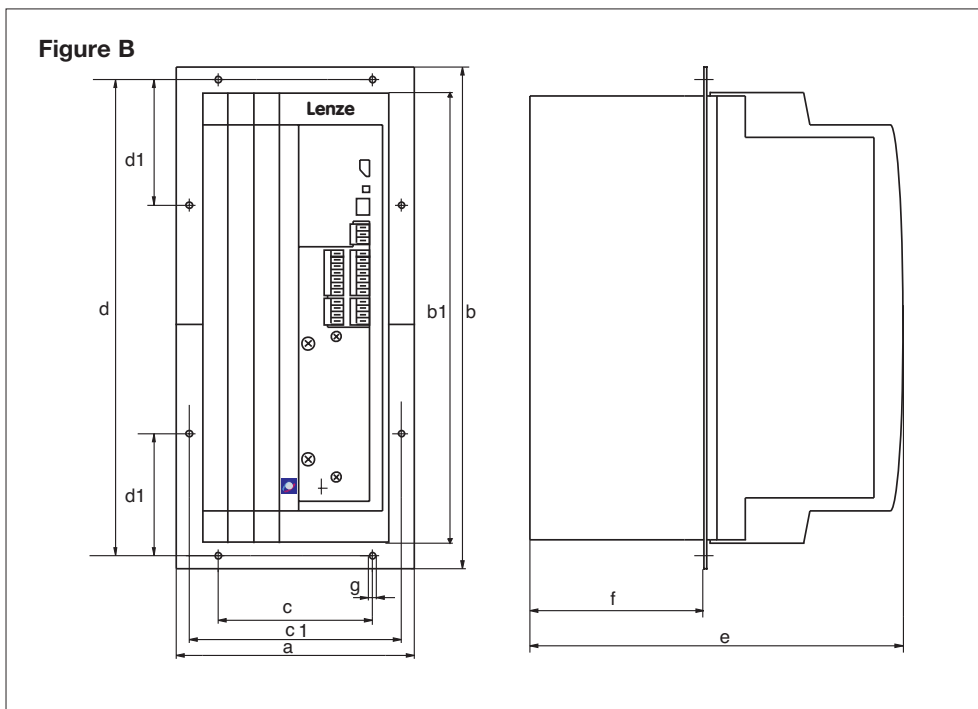
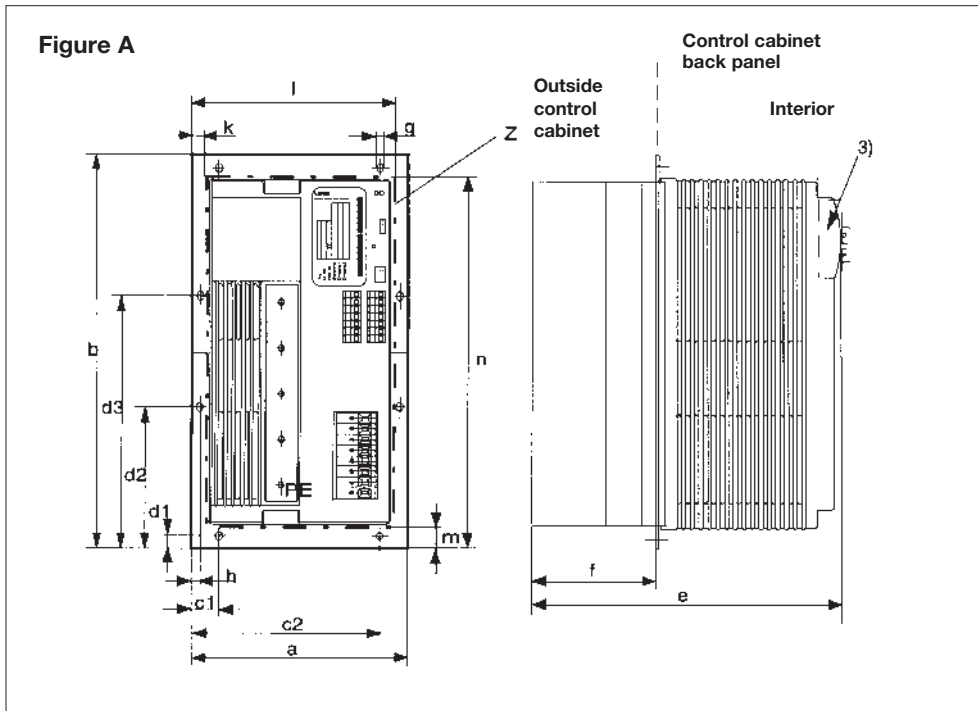

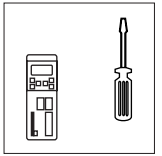
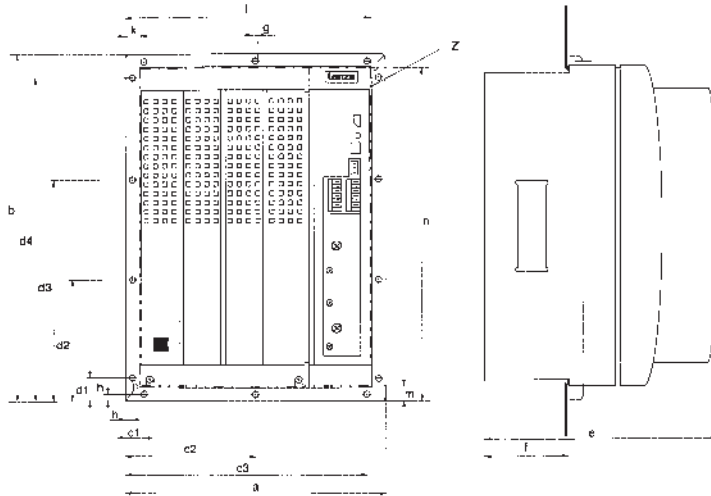

Figure C



Device	Figure	a [mm]	b [mm]	c [mm]	c1 [mm]	c2 [mm]	c3 [mm]	d [mm]	d1 [mm]	d2 [mm]	d3 [mm]	d4 [mm]	e [mm]	f [mm]	g [mm]	h [mm]
8215E	A	162	283	-	31	132	-	-	10	90.5	192.5	-	218	88	6.5	8.5
8216E	A	162	283	-	31	132	-	-	10	90.5	192.5	-	218	88	6.5	8.5
8217E	A	162	283	-	31	132	-	-	10	90.5	192.5	-	218	88	6.5	8.5
8218E	A	162	283	-	31	132	-	-	10	90.5	192.5	-	218	88	6.5	8.5
8241E / 9321EV	B	112.5	385.5	60	95.5	-	-	365.5	105.5	-	-	-	250	92	6.5	-
8242E / 9322EV	B	112.5	385.5	60	95.5	-	-	365.5	105.5	-	-	-	250	92	6.5	-
8243E / 9323EV	B	131.5	385.5	79	114.5	-	-	365.5	105.5	-	-	-	250	92	6.5	-
8244E / 9324EV	B	131.5	385.5	79	114.5	-	-	365.5	105.5	-	-	-	250	92	6.5	-
8245E / 9325EV	B	169.5	385.5	117	152.5	-	-	365.5	105.5	-	-	-	250	92	6.5	-
8246E / 9326EV	B	169.5	385.5	117	152.5	-	-	365.5	105.5	-	-	-	250	92	6.5	-
8221E / 9327EV	C	280	379	-	28	140	252	-	41	141	238	338	250	90	6.0	9.0
8222E / 9328EV	C	280	379	-	28	140	252	-	41	141	238	338	250	90	6.0	9.0
8223E / 9329EV	C	280	379	-	28	140	252	-	41	141	238	338	250	90	6.0	9.0

Installation section

	Height [mm]	Width [mm]	k [mm]	l [mm]	m [mm]	n [mm]
8215 - 8218	250 ± 51	32 ± 5	16 ± 2	147 ± 2	19 ± 2	266 ± 2
8241 - 8242 9321 - 9322	350 ± 3	82 ± 3	20 ± 2	198 ± 2	20 ± 2	359 ± 2
8243 - 8244 9323 - 9324	350 ± 3	101 ± 3	20 ± 2	117 ± 2	20 ± 2	359 ± 2
8245 - 8246 9325 - 9326	350 ± 1	139 ± 3	20 ± 2	259 ± 2	20 ± 2	359 ± 2
8221 - 8223 9327 - 9329	338 ± 1	228 ± 1	20 ± 2	255 ± 2	20 ± 2	359 ± 2

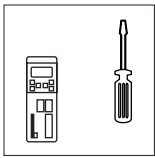

Design - 8200 and 9300 vector

Assembly with other types of fixing

Flat horizontal assembly

8201 - 8204 single-phase devices can also be installed flat with a small additional fan. This may be of particular interest if you are using small machine housings. The additional filter is assembled directly on the inverter.

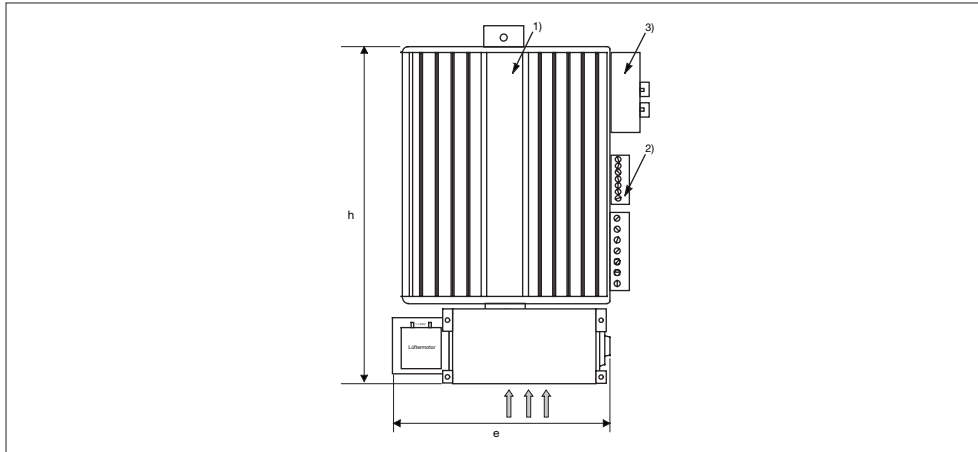

	h [mm]	e [mm]
8201/02	256	110
8203/04	328	110

Assembly on swivel rail

In housings where installation space is limited, the inverter can be installed with a swivel mounting rail.

The inverter can be swung out laterally by 90° for the purposes of installation, setting and diagnostics.

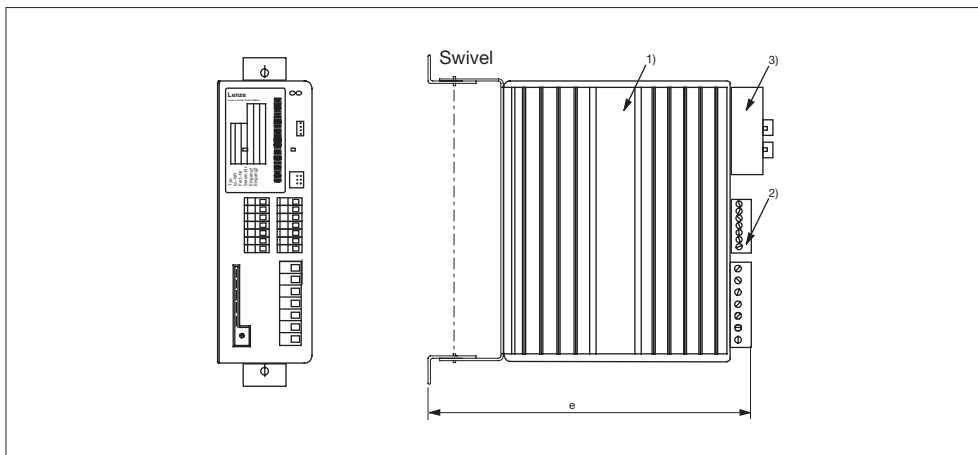

	e [mm]
8201	172
8202	212
8203-14	225

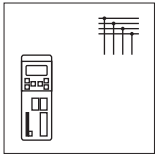

Operation at 150% overload

Fuses or mains automatic circuit breakers can be used for cable protection. Depending on the mains current supply

of each drive controller, the following rated currents are required for the protection devices:

Device	Rated current Protection device	Device	Rated current Protection device
8201	10 A	8203	20 A
8202	15 (16) A	8204	20 A
8211 / 8241 / 8242 / 9321 / 9322EV	6 A	8221 / 9327EV	50 A
8212 / 8243 / 9323EV	10 A	8222 / 9328EV	63 A
8213	10 A	8223 / 9329EV	80 A
8214 / 8244 / 9324EV	10 A	8224 / 9330EV	100 A
8215	16 (13) A	8225 / 9331EV	125 A
8216 / 8245 / 9325EV	20 A	8226 / 9332EV	160 A
8217	25 A	8227 / 9333EV	200 A
8218 / 8246 / 9326EV	32 A		

() Automatic circuit breakers

The values provided are valid for operation with mains choke/mains filter

Operation at 120% overload

Fuses or automatic circuit breakers can be used for cable protection. Depending on the mains current supply of each

drive controller, the following rated currents are required for the protection devices:

Device	Rated current Protection device	Device	Rated current Protection device
8211 / 8241 / 9321EV	6 A		
8212 / 8242 / 9322EV	6 A	8221 / 9327EV	63 A
8213	10 A	8222 / 9328EV	80 A
8214 / 8243 / 9323EV	10 A	8223 / 9329EV	100 A
9324EV	16 (13) A	8224 / 9330EV	125 A
8215 / 8216 / 8244 / 9325EV	20 A	8225 / 9331EV	160 A
		8226 / 9332EV	200 A
8217 / 8218 / 8245 / 8246 / 9326EV	32 A	8227 / 9333EV	250 A

() Automatic circuit breakers

The values provided are valid for operation with mains choke/mains filter

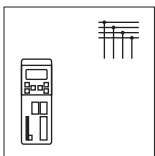

Design - 8200 and 9300 vector

Overview of line protection fuses

Operation at 150% overload

Line protection fuses with frequency-inverter-specific brackets are available for each type of frequency inverter.

Device	Rated current	Fuse		Required number	Fuse holder	
		Size	Order ref.		Order ref.	Required number
8201	M10A	6.3 x 32	EFSM-0100ASB	1	EFH30001	1
8202	M10A	6.3 x 32	EFSM-0100ASB	1	EFH30001	1
8203	M15A	6.3 x 32	EFSM-0150ASC	1	EFH30001	1
8204	M20A	6.3 x 32	EFSM-0200ASC	1	EFH30001	1
8211 / 8241 / 8242 9321 / 9322	M 6A	10 x 38	EFSM-0060AWE	3	EFH10001	3
8212 / 8243 / 9323EV	M10A	10 x 38	EFSM-0100AWE	3	EFH10001	3
8213	M10A	10 x 38	EFSM-0100AWE	3	EFH10001	3
8214 / 8244 / 9324EV	M10A	10 x 38	EFSM-0100AWE	3	EFH10001	3
8215	M16A	10 x 38	EFSM-0160AWE	3	EFH10001	3
8216 / 8245 / 9325EV	M20A	10 x 38	EFSM-0200AWE	3	EFH10001	3
8217	M25A	14 x 51	EFSM-0250AXH	3	EFH10002	3
8218 / 8246 / 9326EV	M32A	14 x 51	EFSM-0320AWH	3	EFH10002	3
8221* / 9327EV*	T50A	-	-	3	-	-
8222* / 9328EV*	T63A	-	-	3	-	-
8223* / 9329EV*	T80A	-	-	3	-	-
8224* / 9330EV*	T100A	-	-	3	-	-
8225* / 9331EV*	T125A	-	-	3	-	-
8226* / 9332EV*	T160A	-	-	3	-	-
8227* / 9333EV*	T200A	-	-	3	-	-

* Recommended for standard fuses

Dimensions

Fuse holder

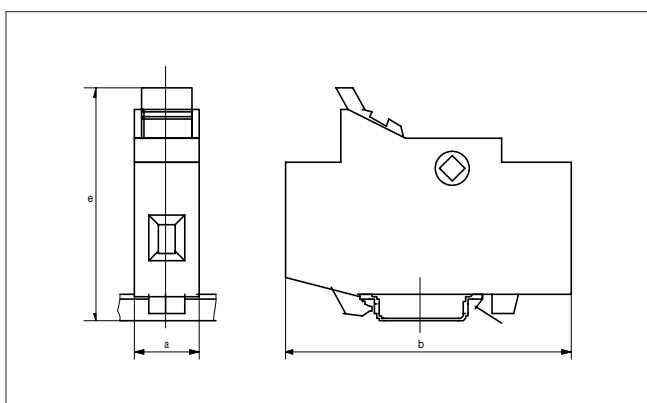

Type	a [mm]	b [mm]	e [mm]	Fuse dimensions
EFH10001	17,5	81	68	10 x 38
EFH10002	26	81	68	14 x 51
EFH30001**	15	63	52	6.3 x 32

** Fixing: Bolt-on

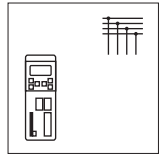

Operation at 120% overload

Line protection fuses with frequency-inverter-specific brackets are available for each type of frequency inverter.

Device	Rated current	Fuse Size	Order ref.	Required number	Fuse holder	
					Order ref.	Required number
8211 / 8241 / 9321EV	M 6A	10 x 38	EFSM-0060AWE	3	EFH10001	3
8212 / 8242 / 9322EV	M 6A	10 x 38	EFSM-0060AWE	3	EFH10001	3
8213 / 8214 / 8243 / 9323EV	M10A	10 x 38	EFSM-0100AWE	3	EFH10001	3
8244 / 9324EV	M16A	10 x 38	EFSM-0160AWE	3	EFH10001	3
8215 / 8216 / 9325EV	M20A	10 x 38	EFSM-0200AWE	3	EFH10001	3
8217 / 8218 8245 / 8246 9326EV	M32A	14 x 51	EFSM-0320AWH	3	EFH10002	3
8221*/9327EV*	T63A	-	-	3	-	-
8222* / 9328EV*	T80A	-	-	3	-	-
8223* / 9329EV*	T100A	-	-	3	-	-
8224* / 9330EV*	T125A	-	-	3	-	-
8225* / 9331EV*	T160A	-	-	3	-	-
8226* / 9332EV*	T200A	-	-	3	-	-
8227* / 9333EV*	T250A	-	-	3	-	-

* Recommended for standard fuses

Dimensions

Fuse holder

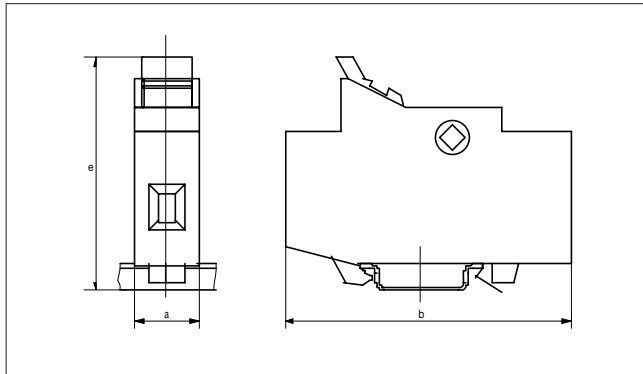

Type	a [mm]	b [mm]	e [mm]	Fuse dimensions
EFH10001	17.5	81	68	10 x 38
EFH10002	26	81	68	14 x 51

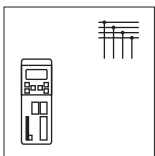

Design - 8200 and 9300 vector

Overview of line circuit breakers

Operation at 150% overload

Frequency-inverter-specific mains automatic circuit breakers are available up to a rated current of 32 A.

Device	Automatic circuit breakers		
	Rated current	Order ref.	Required number
8201	C 10 A	EFA1C10A	1
8202	C 16 A	EFA1C16A	1
8203	C 20A	EFA1C20A	1
8204	C 20A	EFA1C20A	1
8211	B 6A	EFA3B06A	1
8241 / 8242 / 9321EV / 9322EV	B 6A / C 6A*	EFA3B06A	1
8212 / 8243 / 9323EV	B 10A	EFA3B10A	1
8213	B 10A	EFA3B10A	1
8214 / 8244 / 9324EV	B 10A	EFA3B10A	1
8215	B 13A	EFA3B13A	1
8216 / 8245 / 9325EV	B 20A	EFA3B20A	1
8217	B 25A	EFA3B25A	1
8218 / 8246 / 9326EV	B 32A	EFA3B32A	1

* Use circuit breakers with tripping characteristic C for short-term power failures or low-inductance systems.

Dimensions

Automatic circuit breakers

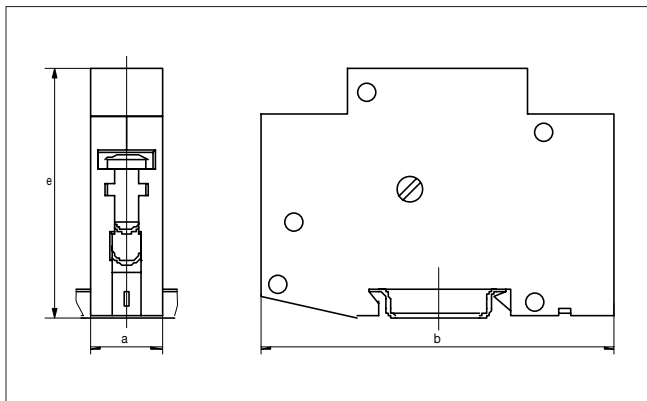

Type	a [mm]	b [mm]	e [mm]
EFA1CXXXXA	17.5	80	63
EFA3BXXXXA	53	90	63

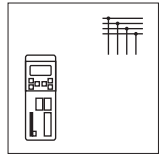

Operation at 120% overload

Frequency-inverter-specific mains automatic circuit breakers are available up to a rated current of 32 A.

Device	Automatic circuit breakers		
	Rated current	Order ref.	Required number
8211 / 8212	B 6A	EFA3B06A	1
8241 / 8242 / 9321EV / 9322EV	B 6A / C 6A*	EFA3B06A	1
8213 / 8214 / 8243 / 9323EV	B 10A	EFA3B10A	1
8244 / 9324EV	B 13A	EFA3B13A	1
8215 / 8216 / 9325EV	B 20A	EFA3B20A	1
8217 / 8218 / 8245 / 8246 / 9326EV	B 32A	EFA3B32A	1

* Use circuit breakers with tripping characteristic C for short-term power failures or low-inductance systems.

Dimensions

Automatic circuit breakers

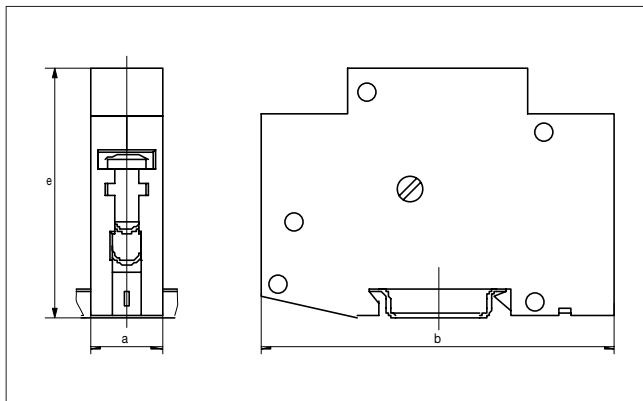

Type	a [mm]	b [mm]	e [mm]
EFA1CXXXA	17.5	80	63
EFA3BXXXA	53	90	63

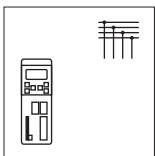

Design - 8200 and 9300 vector

CE-typical installation

General information

- The electromagnetic compatibility of a piece of machinery depends on the installation method and the care taken during installation.

You should pay particular attention to:

- Mounting
- Filters
- Shielding
- Earth connections

The required components are listed in the overview table.

For wiring see the power supply connecting diagram

Installation information

If you follow the measures outlined below you can be sure that no EMC problems caused by the drive system will occur whilst the system is in operation.

- **Mounting**
Ensure that there is sufficient contact between the drive controller and mains choke and the earthed mounting plate:
 - Mounting plates with a conductive surface (galvanised, cadmium-coated) ensure sufficient long-term contact.
 - On coated plates always remove the paint coating from the mounting surfaces.
 - Avoid DIN rail mounting.
- If you are using more than one mounting plate:
 - Ensure generous contact surfaces when connecting the mounting plates (e.g. use copper bands).
- When routing the cables make sure that the motor cables are located away from the signal and mains cables.
- Avoid using a shared terminal strip for mains input and motor output.
- Keep the wiring as close to the reference potential as possible.
Free hanging cables act like aerials.

Filters

- Only use the RFI filters and mains chokes assigned to the devices.
 - RFI filters reduce unwanted HF noise to an acceptable level.
 - Mains chokes reduce the amount of r.m.s. current picked up by the inverter from the mains.
 - Mains filters act both as a mains choke and an RFI filter.

Reducing mains currents, radio interference suppression

Task	Measure				Inverter									
	Mains choke	RFI filter	Mains filter A	Mains filter B	8201-8203	8204	8211-8213	8214	8215-8217	8218	8241-8246 9321EV-9326EV	8221	8222-8227 9327EV-9333EV	CE-typical installation
No measures					▲		▲		▲		▲	▲		-
Reduced mains currents	●				▲	▲	▲	▲	▲	▲	▲	▲	▲	-
Radio interference suppression A		●	○		▲									X
Radio interference suppression A		●		●		▲			▲			▲	▲	X
Radio interference suppression A and reduced mains currents	●	●	○		▲	▲								X
	●	●		○			▲	▲	▲	▲				X
Radio interference suppression B		●			▲									X
				●			▲	▲	▲	▲	▲	▲	▲	X
Radio interference suppression B and reduced mains currents	●	●		○			▲	▲	▲	▲				X

- = essential
- = possible alternative
- ▲ = possible with inverter
- X = CE-conformance ensured by Lenze
- = CE-conformance to be ensured by user

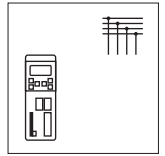

Shielding

- Connect the motor cable shield with the drive controller shield connection.
- If contactors, motor protection switches or terminals are located on the motor cable:
 - Connect the shields of the cables connected there and ensure sufficient contact with the mounting plate.
- In the terminal box of the motor, connect the shield with PE:
 - Metal screw connections for the cables at the motor terminal box ensure sufficient contact between the shield and the housing of the motor.
- If the mains cable between the mains filter and the drive controller is longer than 300 mm:
 - Shield the mains cable.
 - Connect the shield of the mains cable directly with the drive controller and mains filter and ensure sufficient contact with the mounting plate.
- If you are using a brake chopper:
 - Connect the shield of the brake resistor cable directly with the brake copper and brake resistor and ensure sufficient contact with the mounting plate.
 - Connect the shield of the cable between the inverter and the brake chopper directly to the inverter and ensure sufficient contact between the brake chopper and the mounting plate.
- If you are operating the devices on a DC bus:
 - Shield the cables between the inverter (+UG/-UG) and the star point of the DC bus.
 - Ensure that there is sufficient contact on both sides between the shield and the mounting plate.

- Shield the control cables:
 - Shield both ends of the digital control cables.
 - Shield one end of the analog control cables.
 - Use the shortest route possible to connect the shields of the control cables with the designated shield connectors on the drive controller.
- If you are using the devices in residential areas:
 - Provide additional shield attenuation (= 10 dB) to limit radiated interference. The usual way of doing this is to install the devices in standard enclosed metallic and grounded control cabinets or boxes.

Ground connections

- Use appropriate cables from a central grounding point (PE rail) to ground all components (drive controller, mains filter, motor filter).
- You must observe the minimum cross sections defined in the safety regulations:
 - However, in terms of EMC it is not the cable cross section but the cable area and the contact area which are of key importance, i.e. use the largest possible cross sections (large area).

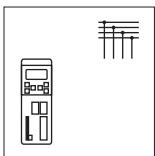

Design - 8200 and 9300 vector

Mains chokes

Operation at 150% overload

Mains choke

A mains choke is an inductive resistor which can be connected before the inverter.

Function:

- Less effects on the mains - the wave form of the mains supply is a closer approximation of a sine wave
- Reduced mains current - reduction of the r.m.s. current (i.e. reduction of mains, cable and fuse load)

- Increased service life - The service life of electrolytic capacitors in the DC bus can be as much as doubled by reducing the AC load.

Please note:

- Only operate 8204, 8214, 8218, 8221-27 and 9327-33 devices with the appropriate mains choke or mains filter.
- If you are using a mains choke, the maximum possible output voltage does not reach the value of the mains voltage - the typical mains voltage drop at the rated value is around 4%.

Technical data

Device	Mains choke			
	Order ref.	Inductance [mH]	I _r [A]	m [kg]
8201	ELN1-0900H005	9.0	5.0	1.0
8202	ELN1-0500H009	5.0	9.0	1.0
8203	ELN1-0350H014	3.5	14.0	2.5
8204	ELN1-0160H017	1.6	17.0	2.5
8211 / 8241 / 8242 9321EV / 9322EV	ELN3-0700H003	7.0	2.5	0.5
8212 / 8243 / 9323EV	ELN3-0450H004	4.5	4.0	0.8
8213	ELN3-0350H006	3.5	5.5	1.0
8214 / 8244 / 9324EV	ELN3-0250H007	2.5	7.0	1.8
8215	ELN3-0160H012	1.6	12	3.8
8216 / 8245 / 9325EV	ELN3-0160H012	1.6	12	3.8
8217	ELN3-0120H017	1.2	17	4.7
8218 / 8246 / 9326EV	ELN3-0120H025	1.2	25	6.0
8221 / 9327EV	ELN3-0088H035	0.88	35.0	9.8
8222 / 9328EV	ELN3-0075H045	0.75	45.0	9.8
8223 / 9329EV	ELN3-0055H055	0.55	55.0	19.0
8224 / 9330EV	ELN3-0038H085	0.38	85.0	19.5
8225 / 9331EV	ELN3-0027H105	0.27	105.0	20.0
8226 / 9332EV	ELN3-0022H130	0.22	130.0	20.0
8227 / 9333EV	ELN3-0017H170	0.17	170.0	32.0

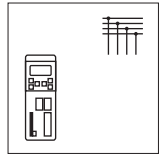

Operation at 120% overload

Mains choke

A mains choke is an inductive resistor which can be connected before the inverter.

Function:

- Less effects on the mains - the wave form of the mains supply is a closer approximation of a sine wave.
- Reduced mains current - reduction of the r.m.s. current (i.e. reduction of mains, cable and fuse load)

- Increased service life – The service life of electrolytic capacitors in the DC bus can be as much as doubled by reducing the AC load.

Please note:

- Only operate 8204, 8214, 8218, 8221–27 and 9327–33 devices with the appropriate mains choke or mains filter.
- If you are using a mains choke, the maximum possible output voltage does not reach the value of the mains voltage – the typical mains voltage drop at the rated value is around 4%.

Technical data

Device	Mains choke			
	Order ref.	Inductance [mH]	I _r [A]	m [kg]
8241 / 9321EV	ELN3-0700H003	7.0	2.5	0.5
8211 / 8212 / 8242 / 9322EV	ELN3-0450H004	4.5	4.0	0.8
8213 / 8214 / 8243 / 9323EV	ELN3-0250H007	2.5	7.0	1.8
8215 / 8216 / 8244 / 9324EV	ELN3-0160H012	1.6	12	3.8
8217 / 8218 / 8245 / 8246 / 9325EV / 9326EV	ELN3-0120H025	1.2	25	6.0
8221 / 9327EV	ELN3-0075H045	0.75	45.0	9.8
8222 / 9328EV	ELN3-0055H055	0.55	55.0	19.0
8223 / 9329EV	ELN3-0055H055	0.55	55.0	19.0
8224 / 9330EV	ELN3-0027H105	0.27	105.0	20.0
8225 / 9331EV	ELN3-0022H130	0.22	130.0	20.0
8226 / 9332EV	ELN3-0017H170	0.17	170.0	32.0
8227 / 9333EV	ELN3-0014H200	0.14	200.0	32.0

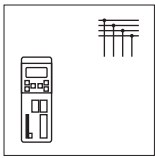

Design - 8200 and 9300 vector

Mains chokes

Dimensions of mains chokes

Order ref.	a [mm]	b [mm]	c [mm]	d [mm]	e [mm]	f [mm]	k [mm]	m [mm]	n [mm]
ELN1-0900H005	66	67	50	53	80	62	80	4.8	9
ELN1-0500H009	66	67	50	53	80	62	80	4.8	9
ELN1-0350H014	96	77	84	61	96	86	86	5.8	11
ELN1-0160H017	96	77	84	61	96	86	86	5.8	11
ELN3-0700H003	65	44	50	30	92	70	56	4.5	9
ELN3-0450H004	65	50	50	36	92	70	62	4.5	9
ELN3-0350H006	74	48	56	34	105	84	60	4.5	9
ELN3-0250H007	120	61	84	45	130	105	73	6.0	11
ELN3-0160H012	150	70	90	54	155	130	81	6.0	11
ELN3-0120H017	120	65	109	51	162	110	80	5.0	10
ELN3-0120H025	150	76	140	61	180	140	95	5.0	10
ELN3-0088H035	180	91	161	74	225	165	120	6.3	11
ELN3-0075H045	180	91	161	74	225	165	120	6.3	11
ELN3-0055H055	228	88	206	69	263	205	120	6.3	11
ELN3-0038H085	228	111	206	94	263	205	140	6.3	11
ELN3-0027H105	228	111	206	94	273	205	150	6.3	11
ELN3-0022H130	264	102	240	81	265	237	135	6.3	11
ELN3-0017H170	264	128	240	107	257	237	166	8.3	16
ELN3-0014H200	300	114	274	88	290	265	135	8.3	16

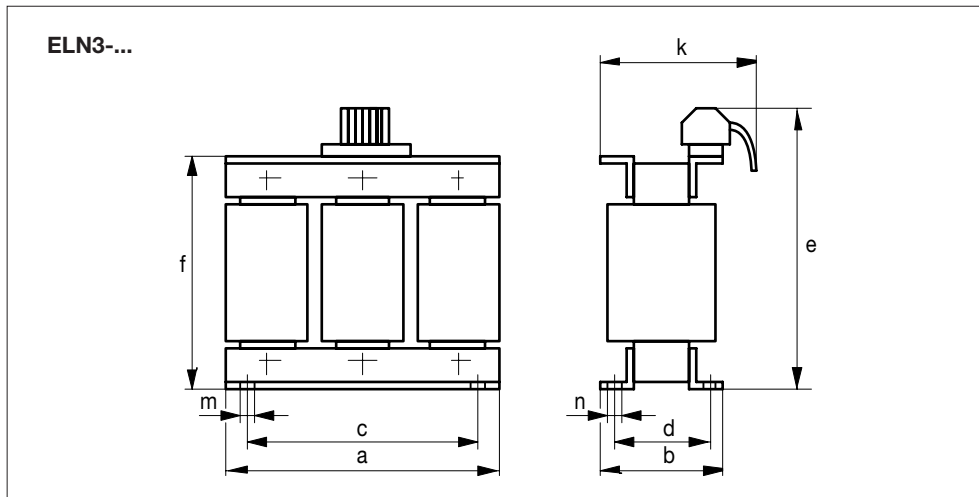
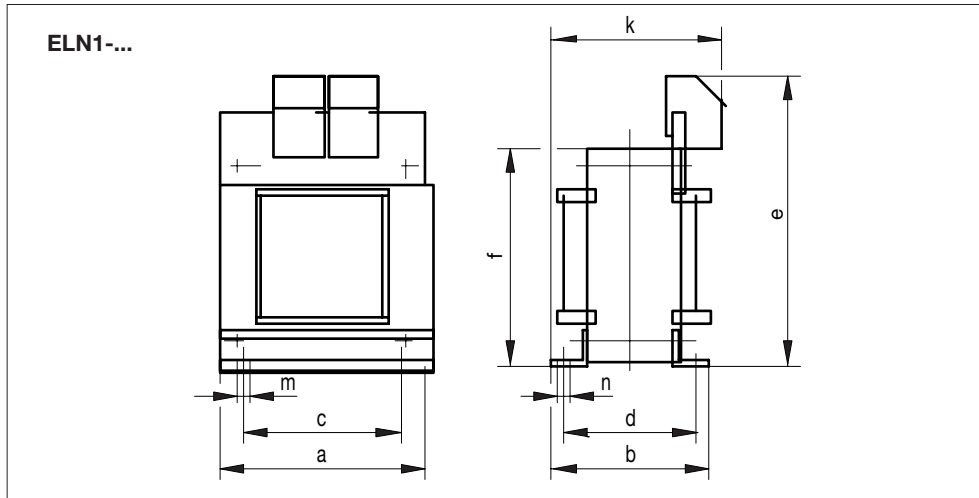
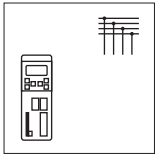

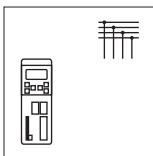

Design - 8200 and 9300 vector

RFI filters

Operation at 150% overload

Interference suppression to EN 55011 Limiting value class A

This limiting value class is often required for industrial networks operating separately from mains supplies in domestic areas. The noise emitted by the connected consumers must not exceed the defined characteristic. In order to meet the requirements of limiting value class A, you must connect an RFI filter before the devices.

RFI filters class A and B

An RFI filter reduces mains-bound electromagnetic interference into the mains network. The filter does not replace the function of the mains choke. In order to reduce the r.m.s. current it is also necessary to install a mains filter or use an additional mains choke.

Interference suppression to EN 55011 Limiting value class B

If the drive is not being operated on an industrial network but in a residential area, it may cause interference on other devices such as radio and television receivers. In this case you must provide a means of radio interference suppression to EN 55011, limiting value class B. Threshold characteristic B is significantly lower than and includes threshold characteristic A.

In order to meet the requirements of limiting value class B, you must connect an RFI filter before the devices. Mains chokes are also required for 821XE devices.

Please note:

The filters indicated for types 821xE are suitable for mains voltages of 440 V +10%. Please contact Lenze if you are working with mains voltages of > 440 V.

Technical data

Device	RFI filter for operation with mains choke				RFI filter for operation without mains choke			
	Order ref.	I _r [A]	U _{mains} [V]	m [kg]	Order ref.	I _r [A]	U _{mains} [V]	m [kg]
8201	EZF1-006A002	6.0	230	0.25	EZF1-006A002	6.0	230	0.25
8202	EZF1-009A002	9.0		0.6	EZF1-009A002	9.0		0.6
8203	EZF1-018A002	18.0		0.8	EZF1-018A002	18.0		0.8
8204	EZF1-018A002	18.0		0.8	Not permitted			
8211	EZF3-008A003	8.0	400	1.0	EZF3-008A003	8.0	400	1.0
8212	EZF3-008A003	8.0		1.0	EZF3-008A003	8.0		1.0
8213	EZF3-008A003	8.0		1.0	EZF3-008A003	8.0		1.0
8214	EZF3-008A003	8.0		1.0	Not permitted			
8215	EZF3-016A003	16.0		2.0	EZF3-016A003	16.0	400	2.0
8216	EZF3-016A003	16.0		2.0	EZF3-024A001	24.0		2.0
8217	EZF3-016A003	16.0		2.0	EZF3-024A001	24.0		2.0
8218	EZF3-024A001	24.0		2.0	Not permitted			

The RFI filters for 8202-8218 have been designed so that they can be installed underneath the inverter. The footprint RFI filters for 8202 frequency inverters can also be used for 8201 frequency inverters.

A mains filter is available for 8241-8246 and 8221-8227 frequency inverters instead of the combination of RFI filter and mains choke (see following pages).

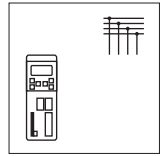

Operation at 120% overload

Interference suppression to EN 55011 Limiting value class A

This limiting value class is often required for industrial networks operating separately from mains supplies in domestic areas. The noise emitted by the connected consumers must not exceed the defined characteristic. In order to meet the requirements of limiting value class A, you must connect an RFI filter before the devices.

RFI filters class A and B

An RFI filter reduces mains-bound electromagnetic interference into the mains network. The filter does not replace the function of the mains choke. In order to reduce the r.m.s. current it is also necessary to install a mains filter or use an additional mains choke.

Interference suppression to EN 55011 Limiting value class B

If the drive is not being operated on an industrial network but in a residential area, it may cause interference on other devices such as radio and television receivers. In this case you must provide a means of radio interference suppression to EN 55011, limiting value class B. Threshold characteristic B is significantly lower than and includes threshold characteristic A.

In order to meet the requirements of limiting value class B, you must connect an RFI filter before the devices. Mains chokes are also required for 821XE devices.

Please note:

The filters indicated for types 821xE are suitable for mains voltages of 440 V +10%. Please contact Lenze if you are working with mains voltages of > 440 V.

Technical data

Device	RFI filter for operation with mains choke			
	Order ref.	I _r [A]	U _{mains} [V]	m [kg]
8211	EZF3-008A003	8.0	400	1.0
8212	EZF3-008A003	8.0		1.0
8213	EZF3-008A003	8.0		1.0
8214	EZF3-008A003	8.0		1.0
8215	EZF3-016A003	16.0		2.0
8216	EZF3-016A003	16.0		2.0
8217	EZF3-024A001	24.0		2.0
8218	EZF3-024A001	24.0		2.0

The RFI filters for 8202-8218 have been designed so that they can be installed underneath the inverter. The footprint RFI filters for 8202 frequency inverters can also be used for 8201 frequency inverters.

A mains filter is available for 8241-8246 and 8221-8227 frequency inverters instead of the combination of RFI filter and mains choke (see following pages).

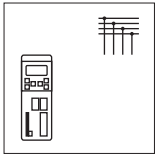

Dimensions of RFI filters

Order ref.	Figure	a [mm]	b [mm]	c [mm]	d [mm]	e [mm]	g [mm]
EZF1-006A002	B	85	50	–	75	40	–
EZF1-009A002	A	60	210	–	190	30	6.5
EZF1-018A002	A	80	283	–	263	40	6.5
EZF3-008A003	A	80	283	–	263	40	6.5
EZF3-016A003	A	120	283	–	263	50	6.5
EZF3-024A001	A	120	283	–	263	50	6.5

Figure A

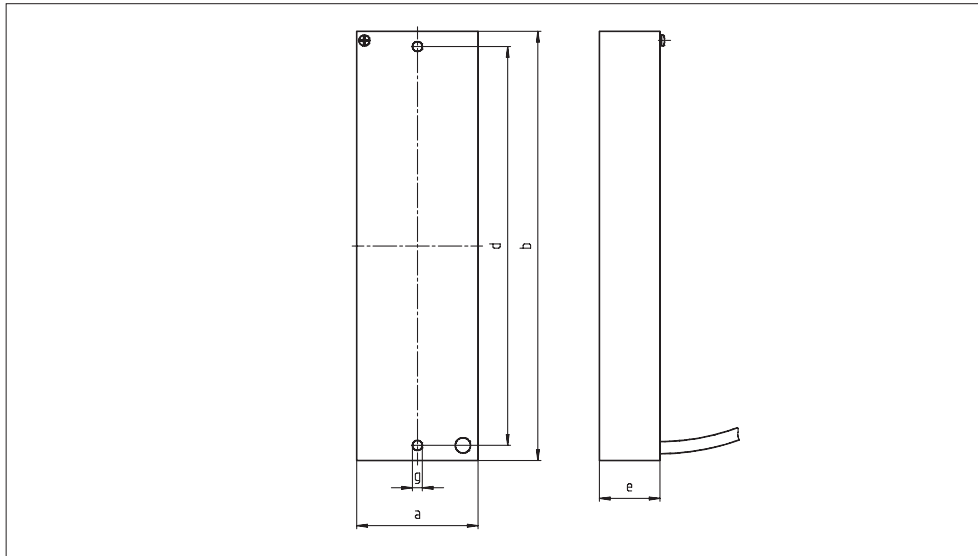
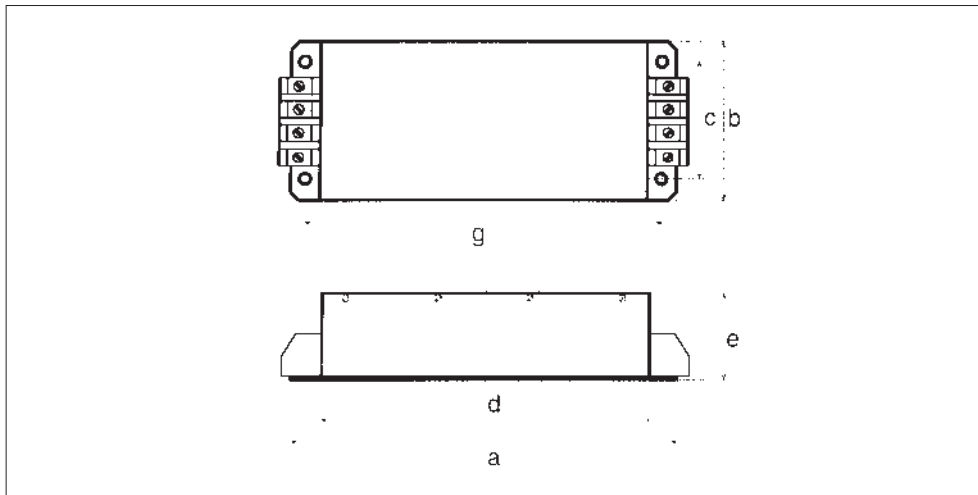
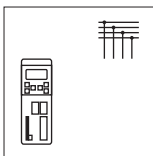

Figure B





Design - 8200 and 9300 vector

Mains filter A

Operation at 150% overload

Mains filter limiting value class A

A mains filter is a combination of inductive resistor and

RFI filter in one housing. It reduces electromagnetic interference into the mains and mains currents.

Technical data

Device	Order ref.	Mains filter			m [kg]
		I_r [A]	L [mH]	U_{mains} [V]	
8201	EZN2-004A001	4.0	2.0	230	0.9
8202	EZN2-008A001	8.0	1.2	230	1.8
8203	EZN2-013A001	13.0	0.7	230	3.0
8204	EZN2-017A001	17.0	0.5	230	3.0
8241 / 9321EV	EZN3A2400H002	1.5	24.0	400...480	0.8
8242 / 9322EV	EZN3A1500H003	2.5	15.0	400...480	1.15
8243 / 9323EV	EZN3A0900H004	4.0	9.0	400...480	1.55
8244 / 9324EV	EZN3A0500H007	7.0	5.0	400...480	2.55
8245 / 9325EV	EZN3A0300H013	13.0	3.0	400...480	5.2
8246 / 9326EV	EZN3A0150H024	24.0	1.5	400...480	8.2
8221 / 9327EV	EZN3A0110H030	30.0	1.1	400...480	16.0
8222 / 9328EV	EZN3A0080H042	42.0	0.8	400...480	17.0
8223 / 9329EV	EZN3A0055H060	60.0	0.55	400...480	30.0
8224 / 9330EV	EZN3A0037H090	90.0	0.37	400...480	40.0
8225 / 9331EV	EZN3A0030H110	110.0	0.30	400...480	46.0
8226 / 9332EV	EZN3A0022H150	150.0	0.22	400...480	60.0
8227 / 9333EV	EZN3A0017H200	200.0	0.17	400...480	90.0

Dimensions of mains filter A for separate assembly

Order ref.	Figure	a [mm]	b [mm]	c [mm]	d [mm]	e [mm]	m [mm]	n [mm]
EZN2-004A001	A	110	78	64	64	92	4.8	8
EZN2-008A001	A	121	91	84	76	135	5.8	9
EZN2-013A001	A	145	121	90	103	140	5.8	12
EZN2-017A001	A	145	121	90	103	140	5.8	12
EZN3A2400H002	B	77	71	50	38	98	5	9
EZN3A1500H003	B	95	82	56	35	115	5	9
EZN3A0900H004	B	95	90	56	43	116	5	9
EZN3A0500H007	B	119	95	90	49	138	5	9
EZN3A0300H013	B	150	106	113	64	162	6	11
EZN3A0150H024	B	180	120	136	67	192	7	12

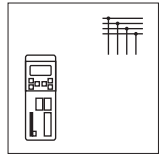

Operation at 120% overload

Mains filter limiting value class A

A mains filter is a combination of inductive resistor and

RFI filter in one housing. It reduces electromagnetic interference into the mains and mains currents.

Technical data

Device	Mains filter				
	Order ref.	I_r [A]	L [mH]	U_{mains} [V]	m [kg]
8241 / 9321EV	EZN3A2400H002	1.5	24.0	400...480	0.8
8242 / 9322EV	EZN3A1500H003	2.5	15.0	400...480	11.5
8243 / 9323EV	EZN3A0750H005	5.0	7.5	400...480	
8244 / 9324EV	EZN3A0400H009	9.0	4.0	400...480	
8245 / 9325EV	EZN3A0300H013	13.0	3.0	400...480	5.2
8246 / 9326EV	EZN3A0150H024	24.0	1.5	400...480	
8221 / 9327EV	EZN3A0080H042	42.0	0.8	400...480	15.0
8222 / 9328EV	EZN3A0060H054	60.0	0.55	400...480	22.0
8223 / 9329EV	EZN3A0055H060	60.0	0.55	400...480	30.0
8224 / 8225 9330 / 9331EV	EZN3A0030H110	110.0	0.30	400...480	45.0
8226 / 9332EV	EZN3A0022H150	150.0	0.22	400...480	60.0
8227 / 9333EV	EZN3A0017H200	200.0	0.17	400...480	90.0

Dimensions of mains filter A for separate assembly

Order ref.	Figure	a [mm]	b [mm]	c [mm]	d [mm]	e [mm]	m [mm]	n [mm]
EZN3A2400H002	B	77	71	50	38	98	5	9
EZN3A1500H003	B	95	82	56	35	115	5	9
EZN3A0750H005	B	100	53	90	39	135	5	9
EZN3A0400H009	B	125	67	113	49	156	6	11
EZN3A0300H013	B	150	106	113	64	162	6	11



Design - 8200 and 9300 vector

Mains filter A

Figure A

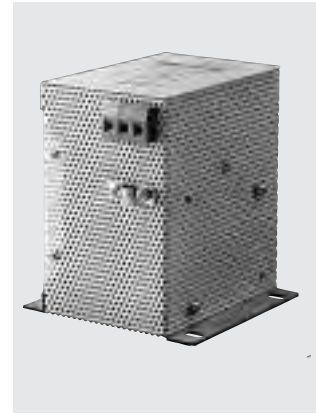
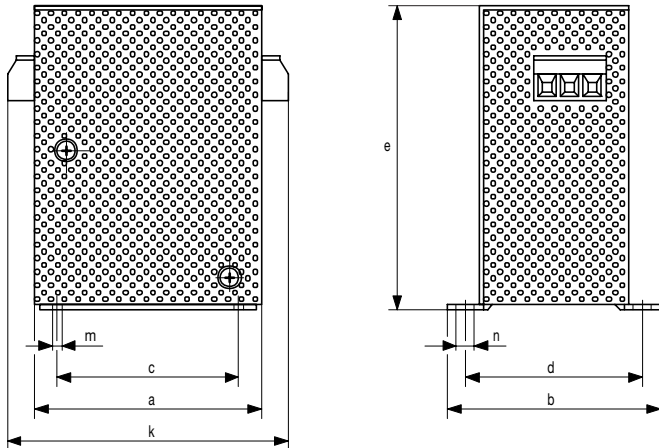
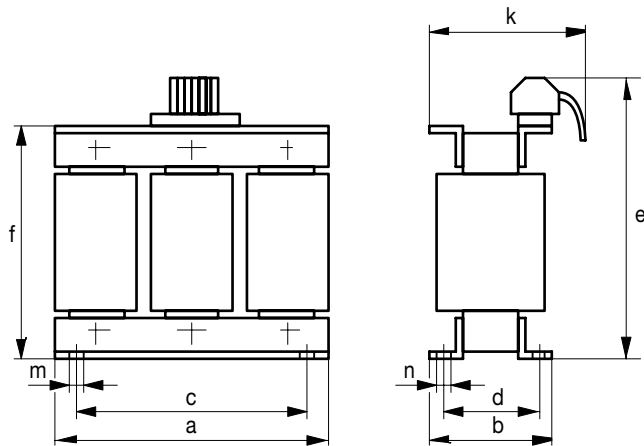
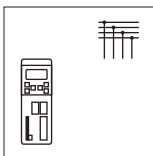

Figure B





Design - 8200 and 9300 vector

Mains filter B

Operation at 150% overload

Mains filter type B

A mains filter is a combination of inductive resistor and

RFI filter in one housing. It reduces electromagnetic interference into the mains and mains currents.

Technical data

Device	Order ref.	Mains filter			m [kg]
		I_r [A]	L [mH]	U_{mains} [V]	
8241 / 9321EV	EZN3B2400H002	1.5	22.0	400...460	2.5
8211 / 8242 / 9322EV	EZN3B1500H003	2.5	15.0	400...460	3.0
8212 / 8243 / 9323EV	EZN3B0900H004	4.0	9.0	400...460	3.3
8213	EZN3B0750H005	5.0	7.5	400...460	4.0
8214 / 8244 / 9324EV	EZN3B0500H007	7.0	5.0	400...460	4.7
8215	EZN3B0400H009	9.0	4.0	400...460	6.5
8216 / 8245 / 9325EV	EZN3B0300H013	13.0	3.0	400...460	12.2
8217	EZN3B0250H015	15.0	2.5	400...460	14.0
8218 / 8246 / 9326EV	EZN3B0150H024	24.0	1.5	400...460	15.3
8221 / 9327EV	EZN3B0110H030	30.0	1.10	400...480	20.0
8222 / 9328EV	EZN3B0080H042	42.0	0.80	400...480	20.0
8223 / 9329EV	EZN3B0055H060	60.0	0.55	400...480	32.0
8224 / 9330EV	EZN3B0033H090	90.0	0.37	400...480	42.0
8225 / 9331EV	EZN3B0030H110	110.0	0.33	400...480	50.0
8226 / 9332EV	EZN3B0022H150	150.0	0.22	400...480	65.0
8227 / 9333EV	EZN3B0017H200	200.0	0.17	400...480	95.0

Dimensions of mains filter B for separate assembly

Order ref.	Figure	a [mm]	b [mm]	c [mm]	d [mm]	e [mm]	m [mm]	n [mm]
EZN3B2200H002	A	78	150	-	135	2309	6.5	-
EZN3B1500H003	A	78	150	-	135	230	6.5	-
EZN3B0900H004	A	78	150	-	135	230	6.5	-
EZN3B0750H005	A	97	180	-	165	230	6.5	-
EZN3B0500H007	A	97	180	-	165	230	6.5	-
EZN3B0400H009	A	97	180	-	165	230	6.5	-
EZN3B0300H013	A	135	260	92	245	230	6.5	-
EZN3B0250H015	A	135	260	92	245	230	6.5	-
EZN3B0150H024	A	135	260	92	245	230	6.5	-

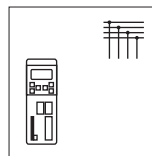

Operation at 120% overload

Mains filter type B

A mains filter is a combination of inductive resistor and

RFI filter in one housing. It reduces electromagnetic interference into the mains and mains currents.

Technical data

Device	Mains filter				
	Order ref.	I_r [A]	L [mH]	U_{mains} [V]	m [kg]
8241 / 9321EV	EZN3B2400H002	1.5	24.0	400...480	0.8
8242 / 9322EV	EZN3B1500H003	2.5	15.0	400...480	1.15
8211 / 8212	EZN3B0900H004	4.0	9.0	400...480	1.55
8243 / 9323EV	EZN3B0750H005	5.0	7.5	400...480	4.0
8213 / 8214	EZN3B0350H007	7.0	3.5	400...480	4.0
8244 / 9324EV	EZN3B0400H009	9.0	4.0	400...480	6.5
8215 / 8216	EZN3B0300H013	13.0	3.0	400...480	12.2
8245 / 9325EV	EZN3B0250H015	15.0	2.5	400...480	14.0
8218 / 8246 / 9326EV	EZN3B0150H024	24.0	1.5	400...480	15.3
8217	EZN3B0120H021	21.0	1.2	400...480	14.0
8221 / 9327EV	EZN3B0080H042	42.0	0.8	400...480	15.0
8222 / 9328EV	EZN3B0055H060	60.0	0.55	400...480	22.0
8223 / 9329EV	EZN3B0055H060	60.0	0.55	400...480	30.0
8224 / 8225 9330 / 9331EV	EZN3B0030H110	110.0	0.30	400...480	45.0
8226 / 9332EV	EZN3B0022H150	150.0	0.22	400...480	65.0
8227 / 9333EV	EZN3B0017H200	200.0	0.17	400...480	95.0

Dimensions of mains filter B for separate assembly

Order ref.	Figure	a [mm]	b [mm]	c [mm]	d [mm]	e [mm]	m [mm]	n [mm]
EZN3B2400H002	A	78	150	-	135	230	6.5	-
EZN3B1500H003	A	78	150	-	135	230	6.5	-
EZN3B0900H004	A	78	150	-	135	230	6.5	-
EZN3B0750H005	A	97	180	-	165	230	6.5	-
EZN3B0350H007	A	97	180	-	165	230	6.5	-
EZN3B0400H009	A	97	180	-	165	230	6.5	-
EZN3B0300H013	A	135	260	92	245	230	6.5	-
EZN3B0150H024	A	135	260	92	245	230	6.5	-
EZN3B0120H021	A	135	260	92	245	230	6.5	-

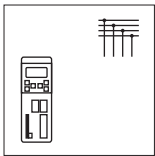

Design - 8200 and 9300 vector

Mains filter B

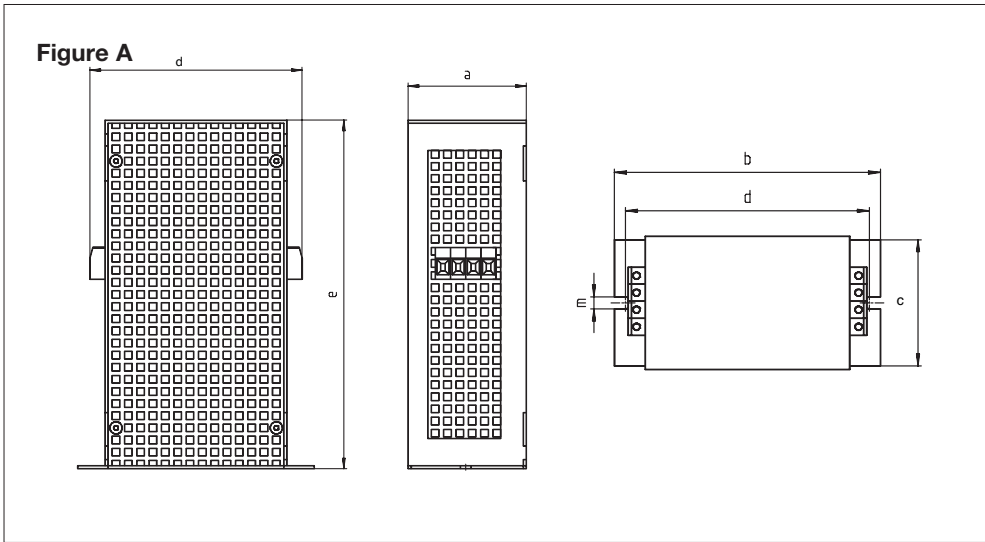

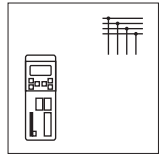

Operation at 150% overload

A mains filter is a combination of mains choke and RFI filter in one housing. It reduces line-bound noise emission into the mains network, thus ensuring that the requirements of limiting value class A/B are met. In addition, a mains filter replaces the function of a mains choke. The r.m.s. current is also reduced.

Important:

- When mounting the frequency inverter according to the “push-through technique” or “cold plate” technology only built-on mains filters can be used for interference suppression.

Device	Mains filter A/B, dimensions [mm]									
	Type	Order ref.	a	a1	b	b1	e	e1	e2	m
8221/9327	E82ZN22334B230	235.5	231	410	350	110	90	11.5	M5	13
8222/9328	E82ZN22334B230			430						
8223/9329	E82ZN30334B230			430						
8224/9330	E82ZN45334B230	318	313.5	580	500	114	90	14.5	M8	26
8225/9331	E82ZN55334B230			685	590					29
8226/9332	E82ZN75334B230	428	423.5	760	670	114	90	14.5	M8	53
8227/9333	E82ZN90334B230			765						53

Note:

- Max. permissible motor cable lengths in order to meet the requirements of limiting value class A/B: 50 m (A) or 10 m (B).
- The frequency inverter is installed on the footprint mains filter using the standard fixtures included in the scope of supply of the frequency inverter.
- The mains filters meet the requirements of UL/cUL.

Schematic diagram

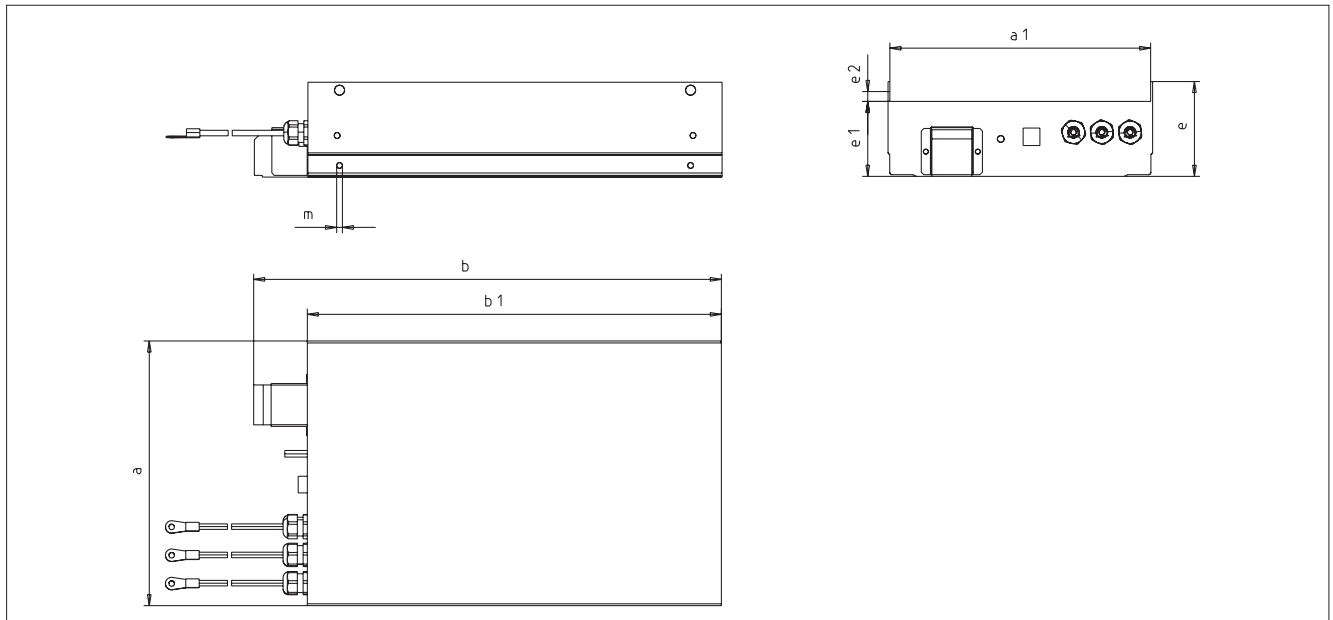

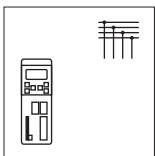

8200 and 9300 vector ranges

Subassembly mains filter limiting value class A and B (15 kW ... 90 kW)

Operating at 120% overload

A mains filter is a mains choke and RFI filter combined in one housing. It reduces line-bound noise emission into the mains network, thus ensuring that limiting value class A/B is satisfied. In addition, a mains filter performs the function of a mains choke. This also means that the mains current's r.m.s. value is reduced.

Important:

- When mounting the frequency inverter using the "push-through technique" or "cold plate" technology only integrated mains filters can be used for interference suppression.

Device	Mains filter A/B, dimensions [mm]									
Type	Order ref.	a	a1	b	b1	e	e1	e2	m	Weight [kg]
8221/9327	E82ZN22334B230	235.5	231	410	350	110	90	11.5	M5	13
8222/9328	E82ZN30334B230			430						19
8224/9330	E82ZN55334B230	318	313.5	685	590	114	90	14.5	M8	29
8226/9332	E82ZN90334B230	428	423.5	765	670					53

Note:

- Max. permitted motor cable lengths in compliance with limiting value class A or B: 50 m (A) or 10 m (B).
- The frequency inverter is installed on the subassembly mains filter using the standard fixtures included in the frequency inverter's scope of supply.
- The mains filters meet the requirements of UL/cUL.

Schematic diagram

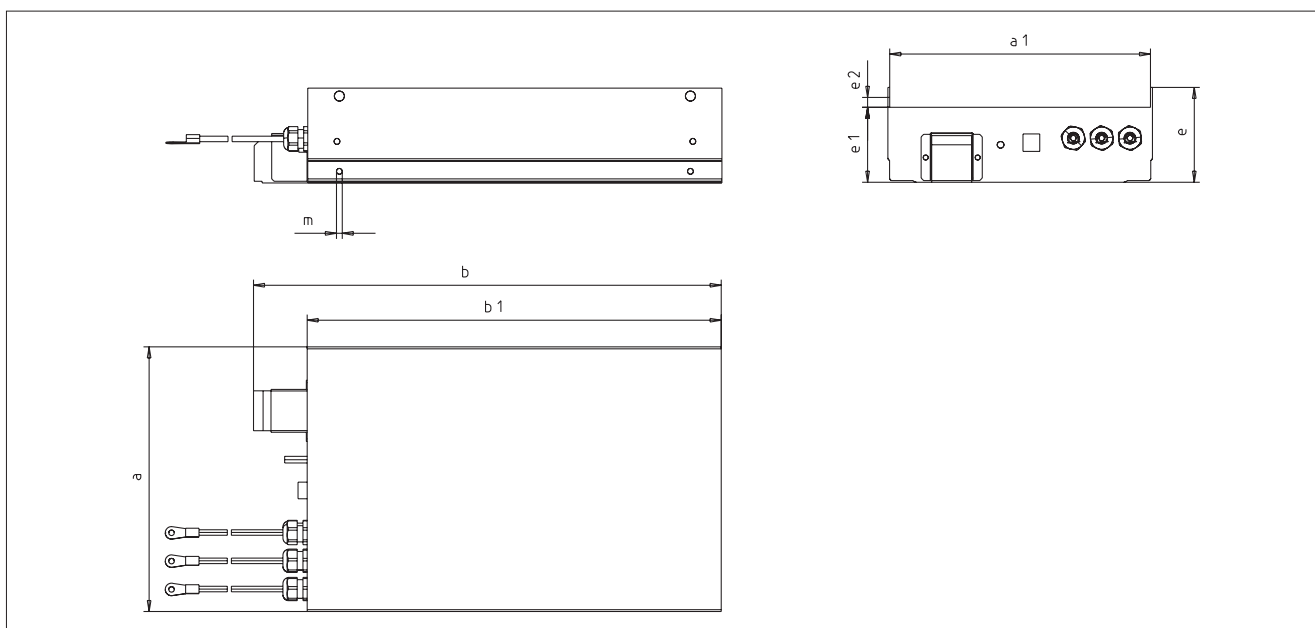

Design - 8200 and 9300 vector

Overview of output filters

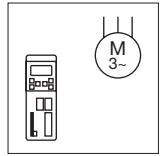

Output filters should be used to reduce the load on the motor coil, as well as to reduce the capacitive leakage currents to PE that may be caused by the use of long

motor cables. Motor filters and sinusoidal filters ensure the safe operation of your drive up to 400 m motor cable length.

Motor filter		Motor filter	Sinusoidal filter
Required at and above motor cable length	Shielded Unshielded	50 m 100 m	100 200 m
Max. motor cable length	Shielded Unshielded	100 m 200 m	200 m 400 m
Min. chopper frequency		4 kHz	8 kHz
Motor protection (du / dt = 500 V / μ s)		Yes	Yes
Max. field frequency		300 Hz	120 Hz
DC bus connection		Yes	-
Reduction of line-side radio interference		Low	Average

Note:

- If you are using motor cables > 200m (shielded) or > 400m (unshielded), please contact Lenze.
- If a number of motors are operating in parallel on the output of one inverter, the following formula should be used to calculate the length of the motor cable:

$$l_{res} = (l_1 + l_2 + \dots + l_n) * \sqrt{n}$$

l_{res} = resulting length

l_1, l_2 = individual motor cable lengths

n = number of parallel motor cables

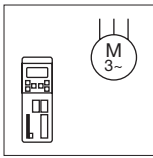

Design - 8200 and 9300 vector

Motor filter

A motor filter is required:

- For long motor cables
> 50 m (shielded) or > 100 m (unshielded)
- If motors are used with an insulation system not suited for inverter operation. Lenze motors feature insulation with a high thermal reserve.

- The typical mains voltage drop via the motor filter at rated current and rated frequency is 2-3% of the output voltage
- The filters indicated are suitable for a mains voltage of up to 3 x 460 V ± 10%
- The +U_G and -U_G terminals must be connected with the same cable cross-section as the motor cable.

Please note:

- The frequency inverter is also loaded with approx. 12% of the motor filter rated current.
- Shielded motor cables are required for a CE-typical installation

Technical data for 150% overload

Device	Motor filter				
	Order ref.	Inductance [mH]	I _r [A]	U _{mains} [V]	m [kg]
8201	ELM3-030H003	3.0	2.5	3 x 230	4.0
8202	ELM3-020H004	2.0	4.0	3 x 230	4.0
8203	ELM3-010H010	1.0	10.0	3 x 230	7.0
8204	ELM3-014H010	1.4	10.0	3 x 230	7.0
8211/ 8241/ 8242 / 9321EV / 9322EV	ELM3-030H004	3.0	4.0	3 x 460	4.0
8212 / 8243 / 9323EV	ELM3-030H004	3.0	4.0	3 x 460	4.0
8213	ELM3-014H010	1.4	10.0	3 x 460	7.0
8214 / 8244 / 9324EV	ELM3-014H010	1.4	10.0	3 x 460	7.0
8215	ELM3-014H010	1.4	10.0	3 x 460	7.0
8216 / 8245 / 9325EV	ELM3-007H025	0.7	25.0	3 x 460	14.0
8217	ELM3-007H025	0.7	25.0	3 x 460	14.0
8218 / 8246 / 9326EV	ELM3-007H025	0.7	25.0	3 x 460	14.0
8221-8222 / 9327-28EV	ELM3-004H055	0.4	55.0	3 x 460	40.0
8223-8227 / 9329-33EV	on request				

Technical data for 120% overload

Device	Motor filter				
	Order ref.	Inductance [mH]	I _r [A]	U _{mains} [V]	m [kg]
8211 / 8241 / 9321EV	ELM3-030H004	3.0	4.0	3 x 460	4.0
8212 / 8242 / 9322EV	ELM3-030H004	3.0	4.0	3 x 460	4.0
8213 / 8214 / 8243 / 9323EV	ELM3-014H010	1.4	10.0	3 x 460	7.0
8215 / 8216 / 8244 / 9324EV	ELM3-007H025	0.7	25.0	3 x 460	14.0
8217 / 8245 / 9325EV	ELM3-007H025	0.7	25.0	3 x 460	14.0
8218 / 8246 / 9326EV	ELM3-007H025	0.7	25.0	3 x 460	14.0
8221 / 9327EV	ELM3-004H055	0.4	55.0	3 x 460	40.0
8222-8227 / 9328EV-9333EV	on request				

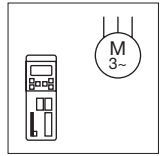

Dimensions of motor filters

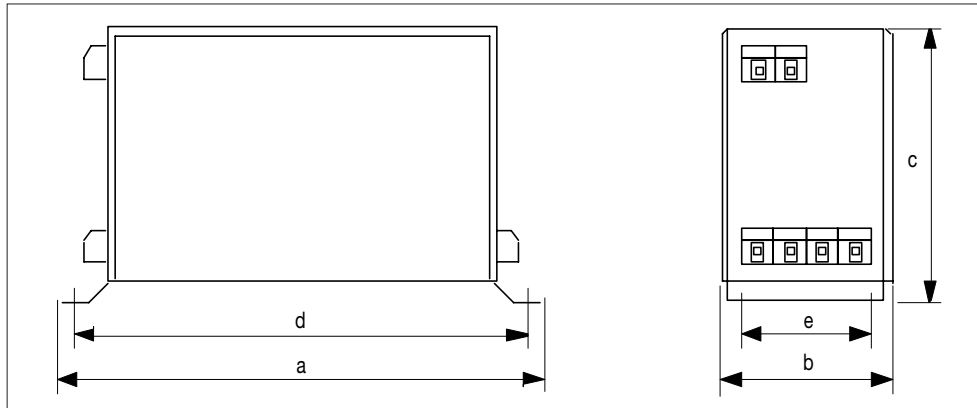

Type	a [mm]	b [mm]	c [mm]	d [mm]	e [mm]
ELM3-030H003	210	60	140	197	35
ELM3-020H004	210	60	140	197	35
ELM3-010H010	280	92	135	267	65
ELM3-030H004	210	75	160	197	50
ELM3-014H010	280	92	175	267	65
ELM3-007H025	280	130	256	267	100
ELM3-004H055	500	235	185	400	220



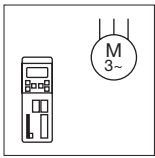

Design - 8200 and 9300 vector

Sinusoidal filters

A motor filter is required:

- For long motor cables > 100 - 200 m (shielded) or > 200 - 400 m (unshielded)

A sinusoidal filter is recommended:

- If inverters are being used for the mains supply to systems which require a specific mains frequency
- On UPS
- In applications in which the noise generation in the motor must be reduced

Please note:

- The frequency inverter is also loaded with approx. 10% of the sinusoidal filter rated current
- The typical mains voltage drop via the sinusoidal filter at rated current and rated frequency ($f_n = 50$ Hz) is 7% of the inverter output voltage
- The maximum permissible field frequency is 120 Hz
- The filters indicated are suitable for a mains voltage of up to $3 \times 460 \text{ V} \pm 10\%$

Technical data for 150% overload

Device	Sinusoidal filter				
	Order ref.	Inductance [mH]	I_r [A]	U_{mains} [V]	m [kg]
8201	EZS3-003A001	12.0	2.6	3 x 230	4.5
8202	EZS3-004A002	8.0	4.0	3 x 230	4.5
8203	EZS3-007A001	4.5	7.0	3 x 230	10.0
8204	EZS3-010A001	3.5	10.0	3 x 230	10.0
8211 / 8241 / 8242 / 9321EV / 9322EV	EZS3-002A001	24.0	2.5	3 x 460	4.5
8212 / 8243 / 9323EV	EZS3-004A002	14.0	4.0	3 x 460	4.5
8213	EZS3-006A001	10.0	5.5	3 x 460	9.0
8214 / 8244 / 9324EV	EZS3-007A002	7.5	7.0	3 x 460	9.0
8215	EZS3-010A002	6.0	9.5	3 x 460	16.0
8216 / 8245 / 9325EV	EZS3-013A001	4.5	13.0	3 x 460	16.0
8217	EZS3-017A001	3.5	16.5	3 x 460	19.0
8218 / 8246 / 9326EV	EZS3-024A001	2.5	24.0	3 x 460	20.0
8221-8227 / 9327-33EV	on request				

Technical data for 120% overload

Device	Sinusoidal filter				
	Order ref.	Inductance [mH]	I_r [A]	U_{mains} [V]	m [kg]
8241 / 9321EV	EZS3-002A001	24.0	2.5	3 x 460	4.5
8211 / 8212 / 8242 / 9322EV	EZS3-004A002	14.0	4.0	3 x 460	4.5
8243 / 9323EV	EZS3-006A001	10.0	5.5	3 x 460	9.0
8213 / 8214	EZS3-007A002	7.5	7.0	3 x 460	9.0
8244 / 9324EV	EZS3-009A002	10.0	5.5	3 x 460	9.0
8215 / 8216 / 8244 / 9324EV	EZS3-013A001	4.5	13.0	3 x 460	16.0
8245 / 9325EV	EZS3-017A001	3.5	16.5	3 x 460	19.0
8217 / 8218 / 8246 / 9326EV	EZS3-024A001	2.5	24.0	3 x 460	20.0
8221-8227 / 9327-33EV	on request				

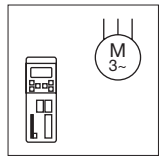

Dimensions of sinusoidal filters

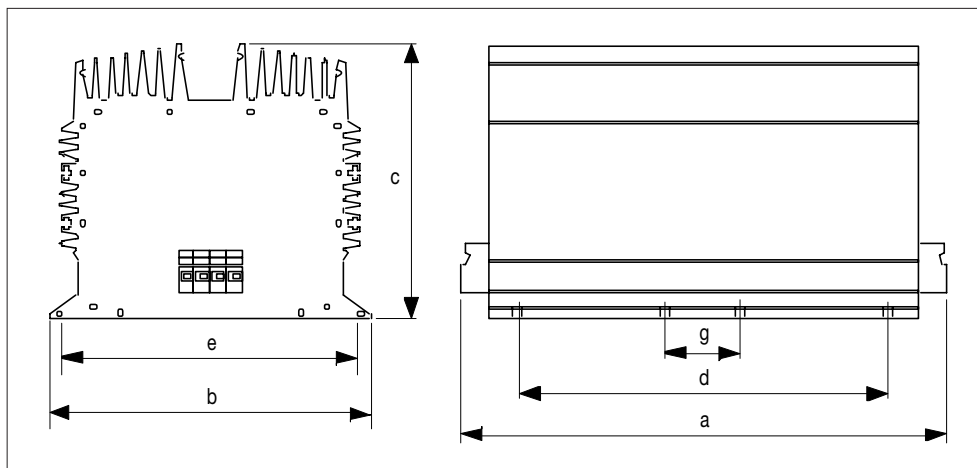
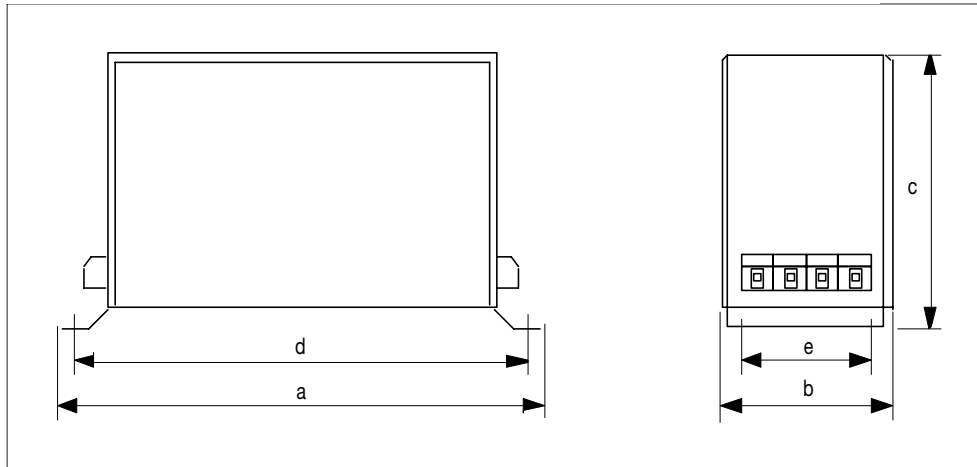

Dimensions of sinusoidal filters

Order ref.	a [mm]	b [mm]	c [mm]	d [mm]	e [mm]
EZS3-003A001	210	75	120	200	50
EZS3-004A002	210	75	120	200	50
EZS3-007A001	280	92	135	270	65
EZS3-010A001	280	92	135	270	65
EZS3-002A001	210	75	160	200	50
EZS3-004A002	210	75	160	200	50
EZS3-006A001	280	92	175	270	65
EZS3-007A002	280	92	175	270	65
EZS3-009A002	280	92	175	270	65
EZS3-010A002	280	130	256	267	100
EZS3-013A001	280	130	256	267	100
EZS3-017A001	280	130	256	267	100
EZS3-024A001	325	200	170	260	185

Larger filters are available on request

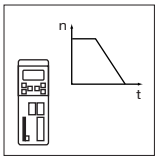

Design - 8200 and 9300 vector

Braking

Options

Braking with brake unit

If a motor is braked quickly by the frequency inverter, the motor will operate in generative mode and feed back energy to the frequency inverter. The DC bus voltage of the frequency inverter increases. If the voltage is too high, the frequency inverter will lock the power stages and the motor will coast to a stop. By using a brake unit comprising a brake module with integrated resistor or brake chopper with external resistor, the feedback energy can be dissipated via the brake resistor and converted into heat. The drive can be braked under controlled conditions.

Feedback mode

A supply and feedback module can also be used as an alternative, in particular on multi-axis and interconnected drives. These components help to reduce energy consumption and costs.

Selecting brake resistors

Brake resistors are selected according to the continuous energy loss exhibited and the energy to be braked. The following formula is used to calculate the rated power of the brake resistors:

$$P_N \geq \frac{t_{Br}}{t_{zyk}} \times P_{max} ; P_{max} = \frac{1}{2} \frac{W_{kin}}{t_{Br}}$$

The maximum kinetic energy to be suppressed is calculated on the basis of the peak brake power and the maximum duty time of the brake chopper.

$$W_{max} = P_{max} \cdot t_{0max}$$

P_{max} : Brake power during braking

t_{Br} : Braking time

t_{cyc} : Time between two braking cycles

W_{kin} : Kinetic energy to be braked

t_{0max} : Maximum duty time of brake chopper

As the frequency change is also applied in the braking phase via the setpoint integrator on the inverter, the "Tif" value set on the inverter can also be used for the braking time t_{Br} .

Design - 8200 and 9300 vector

Brake module 8251 / 52

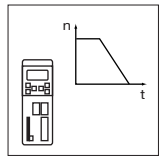

The 8251 and 8252 brake modules are supplied with a built-in brake resistor. The maximum peak brake power is 2.0 kW with a duty cycle of 3% for a maximum of 10 seconds.

The 8251 brake module is for 8201 - 8204 single-phase inverters; the 8252 brake module is for 8211 - 8218 three-phase inverters. If a higher brake power is required, the 8253 brake chopper can be used with an appropriate brake resistor.

Technical data for 8251 / 8252 brake modules

Brake module 8251			
Supply voltage	270...400 V DC		
Threshold		Max. braking energy	20 kW s
At 230 V AC	375 V DC	Min. brake resistance	Integrated
Max. current	5.4 A DC	Ambient temperature	0...+ 40°C
Continuous brake power	70 W	Storage temperature	-25...+ 70°C
Peak brake power	2 kW 3% at max. Duty time 10 s	Humidity	Humidity class F
Brake module 8252			
Supply voltage	450...750 V DC		
Threshold		Max. braking energy	20 kW s
At 400 V AC	725 V DC	Min. brake resistance	Integrated
At 460 V AC	725 V DC	Ambient temperature	0...+ 4°C
Max. current	2.7 A DC	Storage temperature	-25...+ 70°C
Continuous brake power	70 W	Humidity	Humidity class F
Peak brake power	2 kW 3% at max. duty time 10 s		

Dimensions of brake modules

Device	Order ref.	Installation on mounting rail								Installation on DIN rail						
		a [mm]	b [mm]	c [mm]	d [mm]	e [mm]	f [mm]	g [mm]	k [mm]	b [mm]	c1 [mm]	c2 [mm]	c3 [mm]	e [mm]	f [mm]	m [kg]
8251	EMB8251-E	56	210	28	190	170	130	65	30	190	16	98	149	173	133	1.3
8252	EMB8252-E	56	210	28	190	170	130	65	30	190	16	98	149	173	133	1.3

Fixing on mounting rail

Fixing on DIN rail

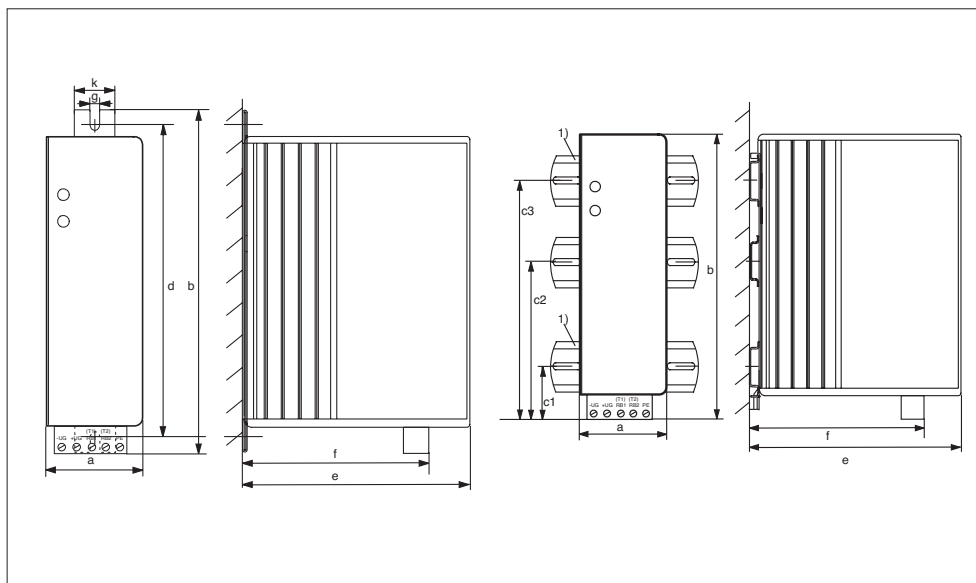

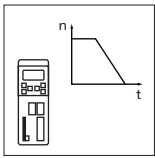

Design - 8200 and 9300 vector

Brake module 9351

The 9351 brake module is supplied with a built-in brake resistor. This brake resistor has a resistance of 47 ohms. The maximum peak brake power is 12 kW at a threshold of 765 V DC. At a pulse/break ratio of 1:250, the maximum duty time is 2 seconds. Depending on the brake power required, the brake module can be used with all

8241-8246, 8221-27 and 9321-33 devices. If a higher brake power is required, the 9352 brake chopper can be used with an appropriate external brake resistor.

Technical data for the 9351 brake module

Supply voltage	270 ... 780 V DC		
Threshold at 400 V AC	630 V DC	Max. braking energy	50 kWS
Threshold at 460 V AC	725 V DC	Min. brake resistance	Integrated
Threshold at 480 V AC	765 V DC		
Max. current	16 A DC	Ambient temperature	0 ... 40°C
Continuous brake power	100 W	Storage temperature	-20 ... 70°C
Peak brake power	12 kW at 1% max. duty time 4 s	Humidity	Humidity class F

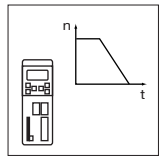

Dimensions of the 9351 brake module

Device	Order ref.	a [mm]	b [mm]	b1 [mm]	c [mm]	d [mm]	e [mm]	g [mm]	k [mm]	m [mm]
EMB9351-E	EMB9351-E	52	384	350	26	365	186	6.5	30	2.6

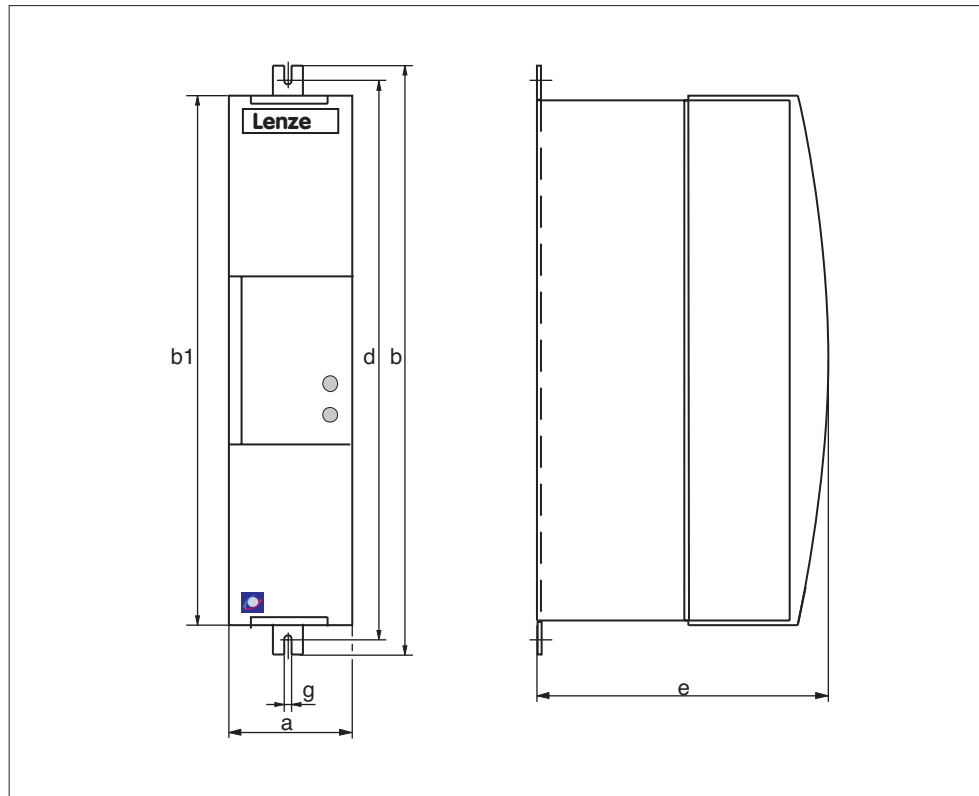

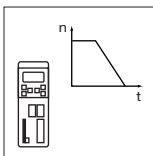

Design - 8200 and 9300 vector

Brake chopper 8253 / 9352

8253 and 9352 brake choppers can be optimised for the required brake power. For this purpose, the brake choppers are operated with an external brake resistor. The minimum brake resistance is 47 ohms on the 8253 and 18 ohms on the 9352.

The brake chopper can be mounted directly adjacent to three-phase 8200 frequency inverters (8253 for 8211-18, 9352 for 8241-46, 8221-27 and 9321-33EV). If a lower brake power is required, a brake module with an integrated brake resistor can be used.

Technical data for the 8253 / 9352 brake choppers

Brake chopper 8253			
Supply voltage	450...750 V DC		
Threshold at 400 V AC	725 V DC	Max. braking energy	According to brake resistance
Threshold at 460 V AC	725 V DC	Min. brake resistance	47 ohms
Max. current	15 A DC	Ambient temperature	0...+ 40°C
Continuous brake power	5.6 kW	Storage temperature	-25...+ 70°C
Peak brake power	11.2 kW 50 % at max. duty time 60 s	Humidity	Humidity class F
Brake chopper 9352			
Supply voltage	270...780 V DC		
Threshold at 400 V	630 V DC	Max. braking energy	According to brake resistance
Threshold at 460 V	725 V DC	Min. brake resistance	18 ohms internal
Threshold at 480 V	765 V DC		
Max. current	42 A DC	Ambient temperature	0...40°C
Continuous braking power	19 kW	Storage temperature	-20...70°C
Peak braking power	32.0 kW 50 % at max. duty time 60 s	Humidity	Humidity class F

Assignment of brake resistor/brake chopper to frequency inverter (example for standard application)

Device	Brake chopper		Brake resistor					
	Order ref.	Minimum Resistance [ohm]	Order ref.	Resistance [ohm]	Peak power [kW]	Perm. power [W]	Thermal capacity [kWs]	m [kg]
8211	EMB8253-E	47	ERBM470R100W	470	1.0	100	15	0.6
8212	EMB8253-E	47	ERBM370R150W	370	1.5	150	22.5	1.0
8213	EMB8253-E	47	ERBM240R200W	240	2.0	200	30	1.3
8214	EMB8253-E	47	ERBD180R300W	180	3.0	300	45	2.0
8215	EMB8253-E	47	ERBD100R600W	100	5.5	600	90	3.1
8216	EMB8253-E	47	ERBD082R600W	82	6.5	600	90	4.1
8217	EMB8253-E	47	ERBD068R800W	68	8.0	800	120	4.1
8218	EMB8253-E	47	ERBD047R01k2	47	12.0	1200	180	4.9
8241 / 9321EV	EMB9352-E	18	ERBM470R050W	470	1.0	100	15.0	0.6
8242 / 9322EV	EMB9352-E	18	ERBM470R100W	470	1.0	100	15.0	0.6
8243 / 9323EV	EMB9352-E	18	ERBM370R150W	370	1.5	300	22.5	1.0
8244 / 9324EV	EMB9352-E	18	ERBD180R300W	180	3.0	300	45.0	2.0
8245 / 9325EV	EMB9352-E	18	ERBD100R600W	100	5.5	600	90.0	3.1
8246 / 9326EV	EMB9352-E	18	ERBD047R01k2	47	12.0	1200	180.0	4.9
8221 / 9327EV	EMB9352-E	18	ERBD033R02k0	33	17.0	2000	300	7.1
8222 / 9328EV	EMB9352-E	18	ERBD022R03k0	22	26.5	3000	450	10.6
8223 / 9329EV	EMB9352-E	18	ERBD018R03k0	18	32.5	3000	450	10.6
8224 / 9330EV	EMB9352-E (2 x)	18	ERBD022R03k0 (2 x)	22	26.5	3000	450	10.6
8225 / 9331EV	EMB9352-E (2 x)	18	ERBD018R03k0 (2 x)	18	26.5	3000	450	10.6
8226 / 9332EV	EMB9352-E (3 x)	18	ERBD022R03k0 (3 x)	22	26.5	3000	450	10.6
8227 / 9333EV	EMB9352-E (3 x)	18	ERBD018R03k0 (3 x)	18	32.5	3000	450	10.6

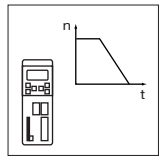

Dimensions of brake choppers

Device	Order ref.	Installation on mounting rail									Installation on DIN rail						
		a [mm]	b [mm]	b1 [mm]	c [mm]	d [mm]	e [mm]	f [mm]	g [mm]	k [mm]	b [mm]	c1 [mm]	c2 [mm]	c3 [mm]	e [mm]	f [mm]	m [kg]
8253	EMB8253-E	56	210	-	28	190	170	130	65	30	190	16	98	149	173	133	1.3
9352	EMB9352-E	52	384	350	26	365	186	-	6.5	30	-	-	-	-	-	2.2	

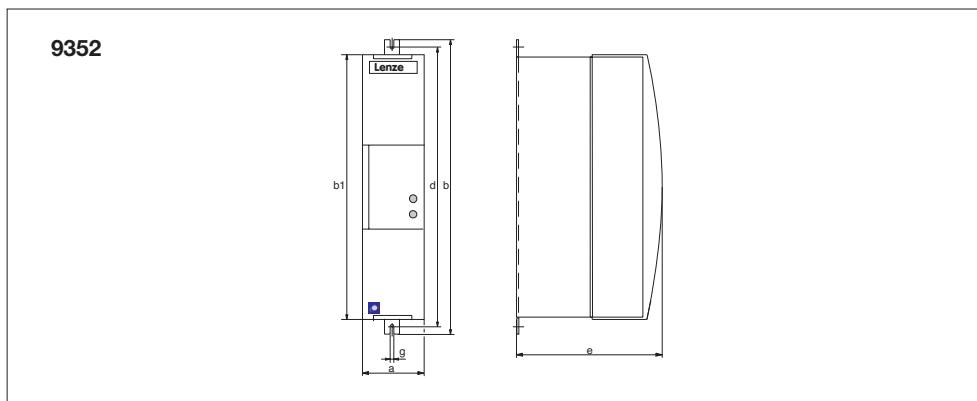
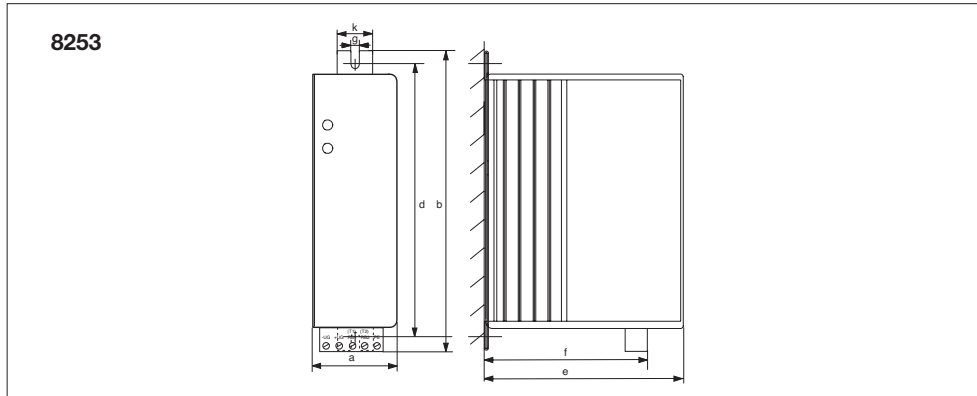

Brake units

- Please note:
 - The assignments listed in the table for the external brake resistors permit a maximum braking time of up to 15 seconds
 - The relative duty time of 10% for a maximum of 15 seconds
- The reference variable for the assignment is the set permanent power of the device.
- Although a higher brake power can be achieved by using other resistors or by connecting a number of resistors in parallel or series, the resistance value must not fall below the minimum specified.
- All brake resistors listed have integrated temperature monitoring with potential-free alarm contact for switching off the mains contactor.

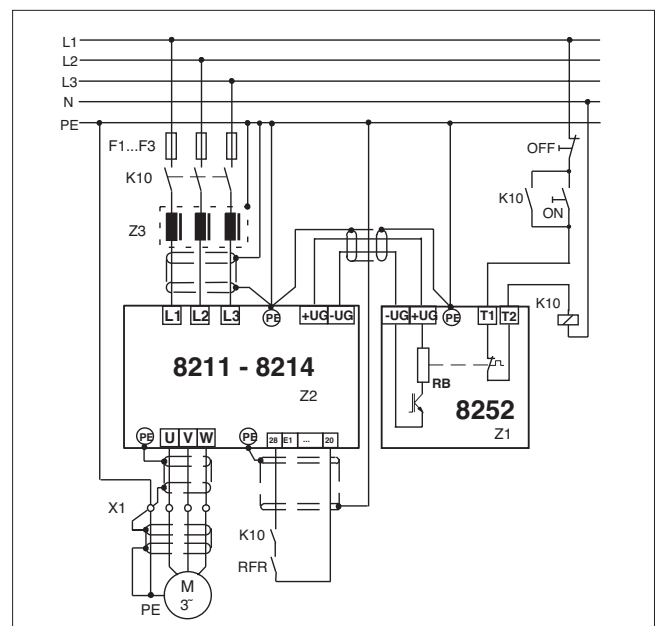

Connection example with brake module

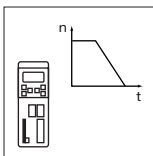

Design - 8200 and 9300 vector

Brake resistors for the 8253 brake chopper

Dimensions of ERBM module brake resistors

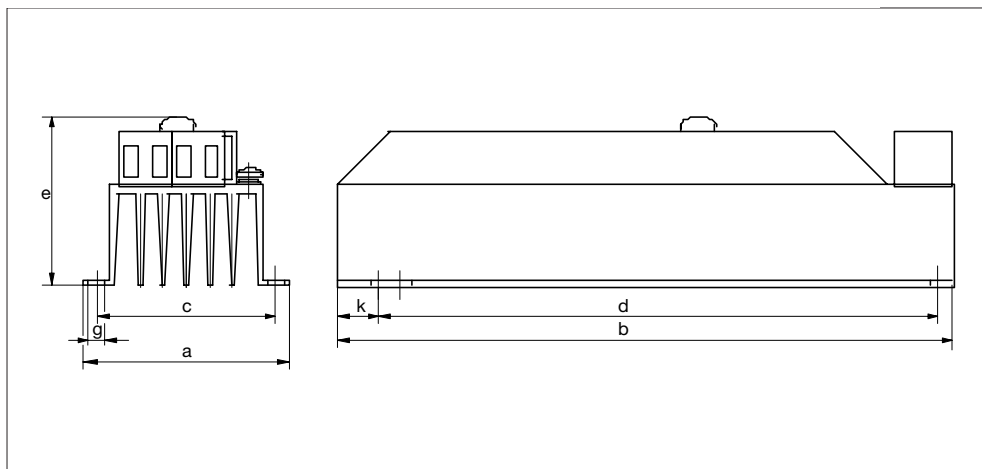

Brake resistor	a [mm]	b [mm]	c [mm]	d [mm]	e [mm]	g [mm]	k [mm]
ERBM470R100W	60	240	50	225	60	5	7.5
ERBM470R100W	70	240	50	225	60	5	7.5
ERBM370R150W	80	240	70	225	95	5	7.5
ERBM240R200W	80	340	70	325	70	5	7.5

Design - 8200 and 9300 vector

Brake resistors for 8253 / 9352 brake choppers

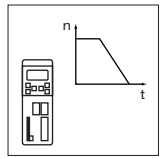

Dimensions of ERBD wire brake resistors

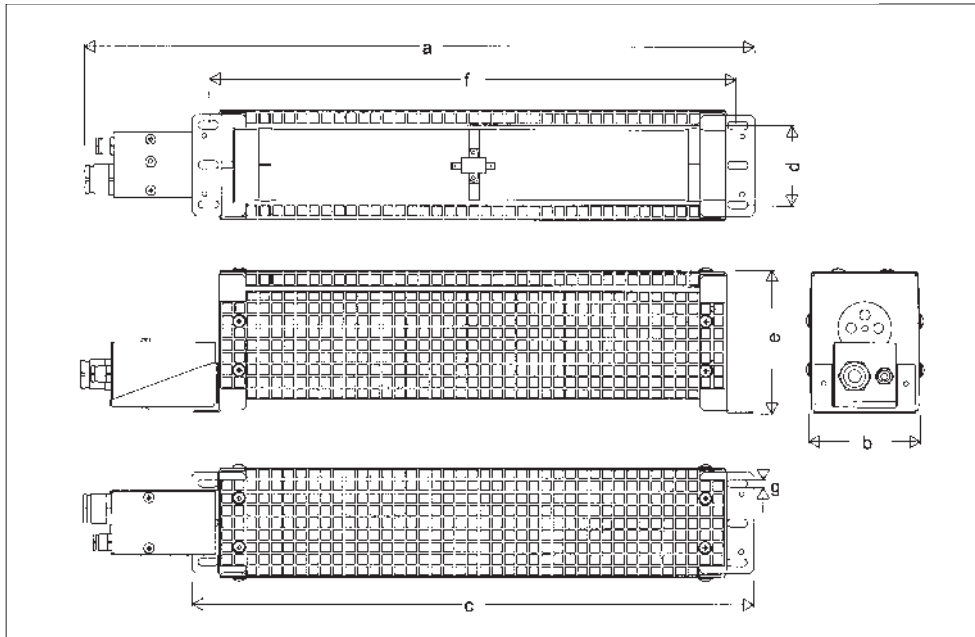

Brake resistor Order ref.	a [mm]	b [mm]	c [mm]	d [mm]	e [mm]	f [mm]	g [mm]	h [mm]
ERBD180R300W	440	89	354	64	115	326	6.5	13
ERBD100R600W	640	89	554	64	115	526	6.5	13
ERBD082R600W	640	89	554	64	115	526	6.5	13
ERBD068R800W	540	177	454	150	115	426	6.5	13
ERBD047R01k2	640	177	554	150	115	526	6.5	13
ERBD033R02k0	640	265	554	240	115	526	6.5	13
ERBD022R03k0	740	177	654	150	229	626	6.5	13
ERBD018R03k0	740	177	654	150	229	626	6.5	13

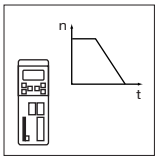

Design - 8200 and 9300 vector

9340 supply and feedback modules

9340 supply and feedback modules can be particularly useful for multi-axis and interconnected drives. These are compact devices with IP20 degree of protection. They can be connected to 8211-8227 and 9321-33EV drive controllers as add-on components and mounted directly adjacent to 8241-8246, 8221-8227 and 9321-33EV frequency inverters.

The brake energy of the frequency inverter is fed back into the mains via the supply and feedback modules.

There are no thermal problems dissipating the brake

energy. Mains filters can be used for the mains connection and DC bus fuses for DC-bus operation.

Brake modules or brake choppers can also be used instead of the supply and feedback module. These modules convert the brake energy into heat.

General data for supply and feedback modules

Humidity	Humidity class F, no condensation (relative humidity 85%, no condensation)
Transport temperature	-25 ... 70°C
Storage temperature	25 ... 55°C
Operating temperature	0 ... 40°C 40 ... 50°C with power derating 2.5% per K
Noise immunity	IEC801-2 to 5 intensity 4
Pollution degree	VDE 110 Part 2 pollution degree 2
Insulation strength	VDE 0110 overvoltage category III
Packaging	To DIN 4180
Degree of protection	IP 20 NEMA 1
Approval	CE conformance and UL approval
Air pressure	100% rated current up to 900 mbar (approx. 1000 m above sea level) acc. to VDE 875 Part 1 and pr EN 55082

Ratings

Type	9341	9342	9343
Mains voltage	320 ... 528 V $\pm 0\%$		
Mains frequency	48 ... 62 Hz $\pm 0\%$		
Feedback power [kVA] ¹⁾	8.3	16.6	31.2
Mech. total power of the motors connected via the drive controller (kW)	5.5	11.0	22.0
Rated mains current [A]	12.0	24.0	45.0
Max. mains current [A]	18.0	36.0	67.5
Power loss [W]	100	200	400

¹⁾ Electrical output power for motive and generative mode

DC bus fuses see page 91

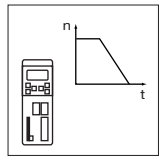

Dimensions

Device	a [mm]	b [mm]	b1 [mm]	c [mm]	c1 [mm]	d [mm]	d1 [mm]	e [mm]	e1 [mm]	g [mm]	k [mm]	m [kg]
9341	135	384	350	21.5	92	365	–	230	250	6.5	30	7.5
9342	135	384	350	21.5	92	365	–	230	250	6.5	30	7.5
9343	250	404	350	14	205	396	24	230	250	6.5	25	12.5

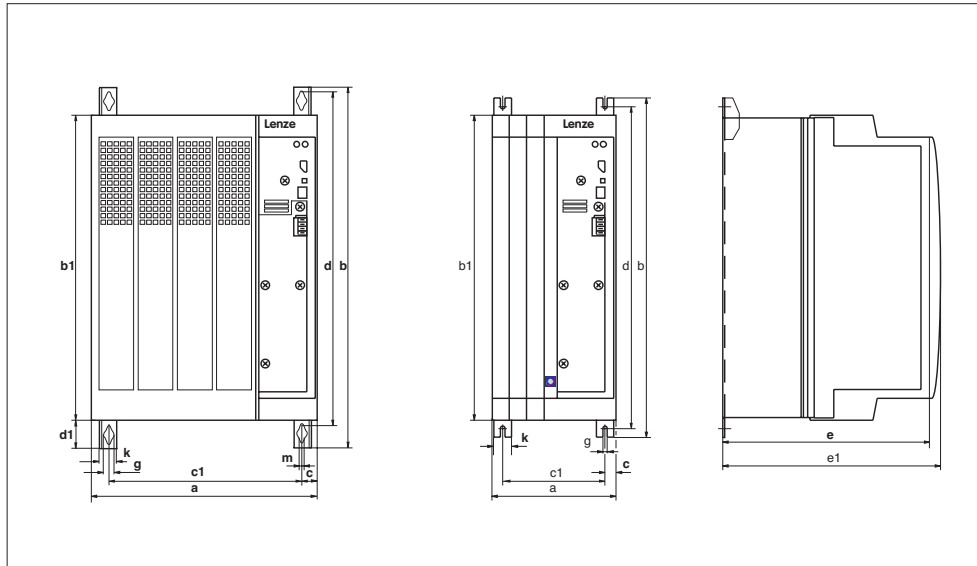

Like 8215-27 frequency inverters, thermal separation can be integrated into supply and feedback modules.

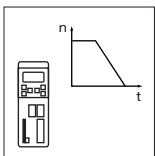

Design - 8200 and 9300 vector

9340 supply and feedback modules

Mains filter A

Depending on the application, various line-side measures can be used for mains current reduction and interference suppression on supply and feedback modules. The mains filter described overleaf or the assigned mains choke is required.

Limiting value class A is often required for industrial networks operating separately from mains supplies in domestic areas. The noise emitted by the connected consumers must not exceed the defined characteristic. In order to meet the requirements of limiting value class A, you can connect a mains filter A before the supply and feedback modules.

Technical data

Device	Mains filter A				
	Order ref.	I_r [A]	U_{mains} [V]	Inductance [mH]	m [kg]
9341	EZN3A0120H012	12.0	480	1.20	4.7
9342	EZN3A0088H024	24.0	480	0.88	12.2
9343	EZN3A0055H045	45.0	480	0.55	15.0

Dimensions of mains filter A

Order ref.	Figure	a [mm]	b [mm]	c [mm]	d [mm]	e [mm]	m [mm]	n [mm]					
EZN3A0120H012	A	135	260	135	245	230	7.0	-					
EZN3A0088H024	A	135	380	135	365	230	7.0	-					
EZN3A0055H045	B	a	b	b ₁	c	d	d ₁	d ₂	d ₃	d ₄	e	m	n
		278	710	365	258	670	22	300	38	300	250	11	6.5

Figure A

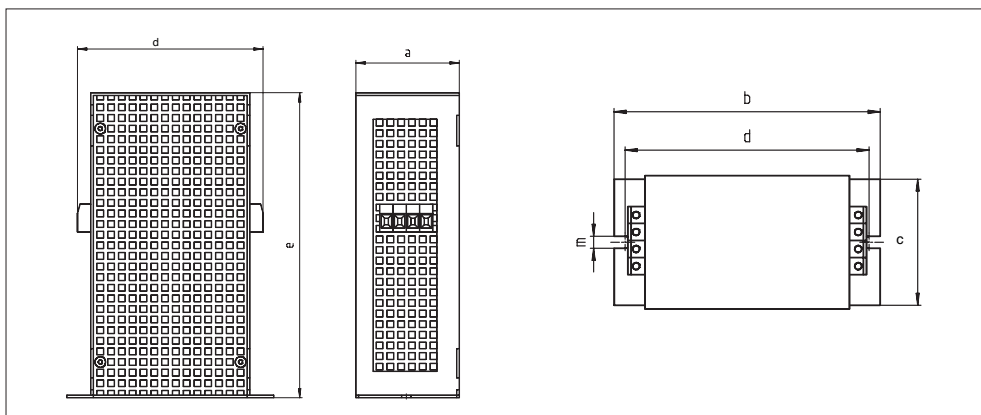
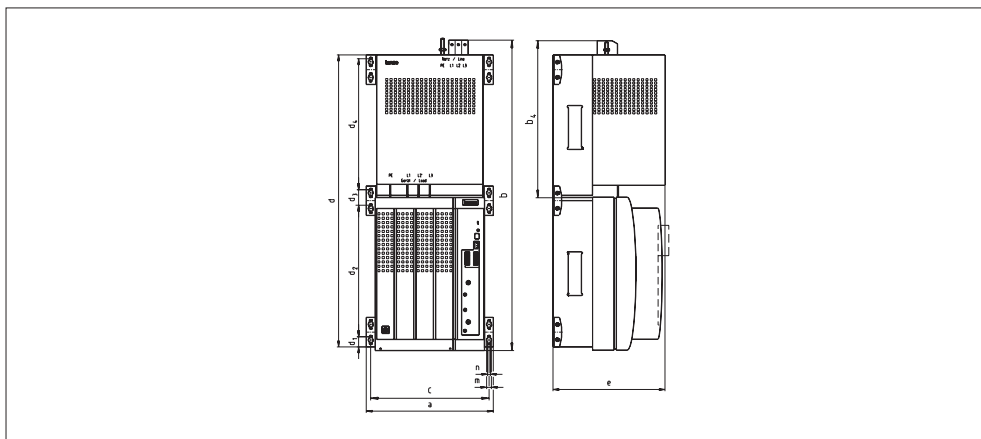
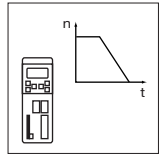

Figure B



The mains filter has an adapted connection cable and must therefore be connected directly to the supply and feedback unit.



DC fuses for DC-bus operation and DC power supply

Two ranges of fuses are required to provide DC fuses for the entire power range of the drive controller. Fuse size 14*51 mm covers the rated current range from 6 to 40 A and fuse size 22*58 mm covers the range from 12 to 100 A. Only fuse holders of the same size may be interconnected via DC busbars. DC currents above 100 A

can be implemented by connecting 22*58 mm DC fuses in parallel.

Note: A DC busbar system is available for each fuse range. At average supply levels, the current capacity $I = 200$ A.

Device		14*51 fuse without signalling device	
Type	Power [kW]	Fuse rated current [A]	Order ref.
8211	0.75	6	EFSGR0060AYHN (2x)
8212	1.5	10	EFSGR0100AYHN (2x)
8213	2.2	12	EFSGR0120AYHN (2x)
8214	3	20	EFSGR0200AYHN (2x)
8215	4	25	EFSGR0250AYHN (2x)
8216	5.5	32	EFSGR0320AYHN (2x)
8217	7.5	40	EFSGR0400AYHN (2x)
8218	11	40	EFSGR0400AYHN (2x)
8241	0.37	10	EFSGR0100AYHN (2x)
8242	0.75	10	EFSGR0100AYHN (2x)
8243	1.5	10	EFSGR0100AYHN (2x)
8244	3	20	EFSGR0200AYHN (2x)
8245	5.5	32	EFSGR0320AYHN (2x)
8246	11	40	EFSGR0400AYHN (2x)
9321	0.37	10	EFSGR0100AYHN (2x)
9322	0.75	10	EFSGR0100AYHN (2x)
9323	1.5	10	EFSGR0100AYHN (2x)
9324	3	20	EFSGR0200AYHN (2x)
9325	5.5	32	EFSGR0320AYHN (2x)
9326	11	40	EFSGR0400AYHN (2x)
9341		32	EFSGR0320AYHN (2x)
9351		20	EFSGR0200AYHN (2x)

Lenze offers a DC busbar system - EWZ 0036 - for DC fuses 14*51 mm.

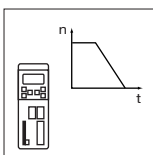

Design - 8200 and 9300 vector

DC fuses

Device		22*58 fuse without signalling device	
Type	Power [kW]	Fuse rated current [A]	Order ref.
8211	0.75	12	EFSGR0120AYIN (2x)
8212	1.5	12	EFSGR0120AYIN (2x)
8213	2.2	12	EFSGR0120AYIN (2x)
8214	3	20	EFSGR0200AYIN (2x)
8215	4	25	EFSGR0250AYIN (2x)
8216	5.5	32	EFSGR0320AYIN (2x)
8217	7.5	40	EFSGR0400AYIN (2x)
8218	11	40	EFSGR0400AYIN (2x)
8221	15	80	EFSGR0800AYIN (2x)
8222	22	100	EFSGR1000AYIN (2x)
8223	30	80	EFSGR0800AYIN (4x)
8224	45	100	EFSGR1000AYIN (4x)
8225	55	80	EFSGR0800AYIN (6x)
8226	75	100	EFSGR1000AYIN (6x)
8227	90	100	EFSGR1000AYIN (8x)
8241	0.37	12	EFSGR0120AYIN (2x)
8242	0.75	12	EFSGR0120AYIN (2x)
8243	1.5	12	EFSGR0120AYIN (2x)
8244	3	20	EFSGR0200AYIN (2x)
8245	5.5	32	EFSGR0320AYIN (2x)
8246	11	40	EFSGR0400AYIN (2x)
9321	0.37	12	EFSGR0120AYIN (2x)
9322	0.75	12	EFSGR0120AYIN (2x)
9323	1.5	12	EFSGR0120AYIN (2x)
9324	3	20	EFSGR0200AYIN (2x)
9325	5.5	32	EFSGR0320AYIN (2x)
9326	11	40	EFSGR0400AYIN (2x)
9327	15	80	EFSGR0800AYIN (2x)
9328	22	100	EFSGR1000AYIN (2x)
9329	30	80	EFSGR0800AYIN (4x)
9330	45	100	EFSGR1000AYIN (4x)
9331	55	80	EFSGR0800AYIN (6x)
9332	75	100	EFSGR1000AYIN (6x)
9333	90	100	EFSGR1000AYIN (8x)
9341		32	EFSGR0320AYIN (2x)
9342		50	EFSGR0500AYIN (2x)
9343		100	EFSGR1000AYIN (2x)
9351		20	EFSGR0200AYIN (2x)
9352		50	EFSGR0500AYIN (2x)

Lenze offers a DC busbar system - EWZ0037 - for DC fuses 22*58 mm.

Design - 8200 and 9300 vector

DC fuses

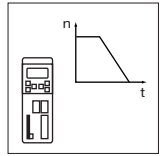

Fuse holder 14*51 mm	
Designation	Order ref.
Fuse holder, 2-pin, without signalling device ¹⁾	EFH20005

Fuse holder 22*58 mm	
Designation	Order ref.
Fuse holder, 2-pin, without signalling device ¹⁾	EFH20007

Miscellaneous accessories ²⁾	
Designation	Order ref.
DC busbar for 14*51 mm, 1m	EWZ0036
DC busbar for 22*58 mm, 1m	EWZ0037
Fuse-link contacts for DC busbar (unit packs of 10)	EWZ0038
1-pin terminal for internal supply of busbars for 14*51 and 22*58 mm ²⁾	EWZ0039

¹⁾ UL approval only for AC operation.

²⁾ The terminal provides a simple way of connecting a central power supply to the busbar system and of connecting busbar systems. Two terminals are required in each instance.

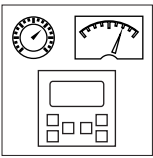

Design - 8200 and 9300 vector

8201BB operating module

The key to the 8200 frequency inverter

- Parameter settings:
The default factory settings of the 8200 frequency inverter (menus) meet the requirements of many common applications. The operating module, which can be attached to the front panel, provides an easy and user-friendly means of adapting all frequency inverter parameters to your requirements.
- Transferring parameter sets:
Even when the voltage is not connected, the built-in non-volatile memory can be used to buffer the parameter sets in the operating module.
- Drive control:
The drive can be controlled using the operator module keypad. The operating module can be expanded with a diagnosis terminal with up to 10 m of connection cable.
- Error and status message display:
The LCD display provides an easy and quick means of monitoring your drive.

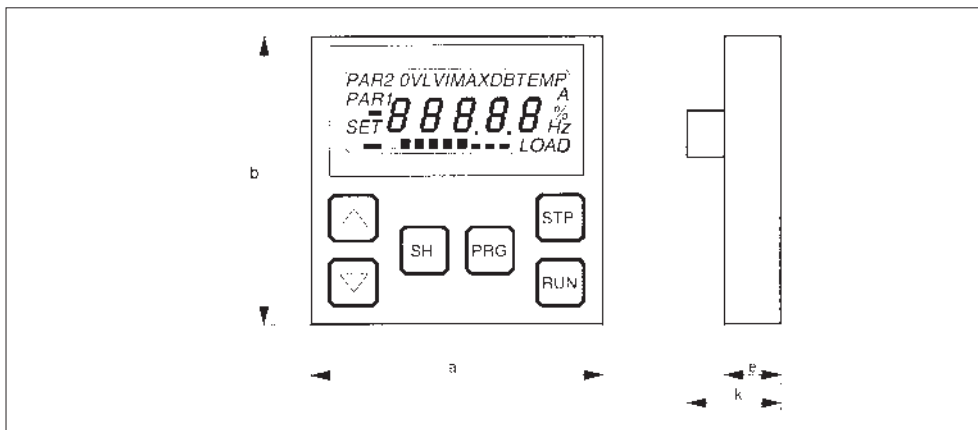

Operating module	Order ref.	a [mm]	b [mm]	e [mm]	k [mm]
EMZ8201BB	EMZ8201BB	60.5	60	12	21

Diagnosis terminal for the operating module

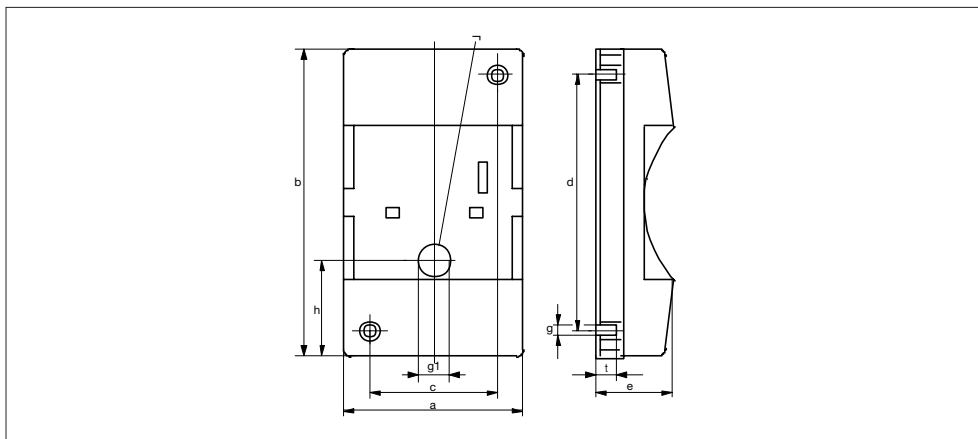

① Bore for control cabinet installation

Diagnosis terminal	Cable length [m]	a [mm]	b [mm]	c [mm]	d [mm]	e [mm]	g [mm]	g ¹ [mm]	h [mm]	t [mm]
EMZ8272BB-V001	2.5	70	120	50	100	30	3.8	12	37.5	8
EMZ8272BB-V002	5.0									
EMZ8272BB-V003	10.0									

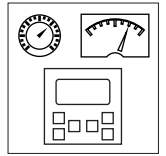

The key to the 9300 vector frequency inverter

- Parameter settings:
The default factory settings of the 9300 frequency inverter (menus) meet the requirements of many common applications. The operating module, which can be attached to the front panel, provides an easy and user-friendly means of adapting all servo inverter parameters to your requirements.
- Transferring parameter sets:
Even when the voltage is not connected, the built-in non-volatile memory can be used to buffer a parameter set in the operating module.
- If several drives are in use then the operating module can be used to transfer parameter sets from one controller to another.
- Drive control:
The drive can be controlled using the operator module keypad.
- Error and status message display:
The LCD display provides an easy and quick means of monitoring your drive.

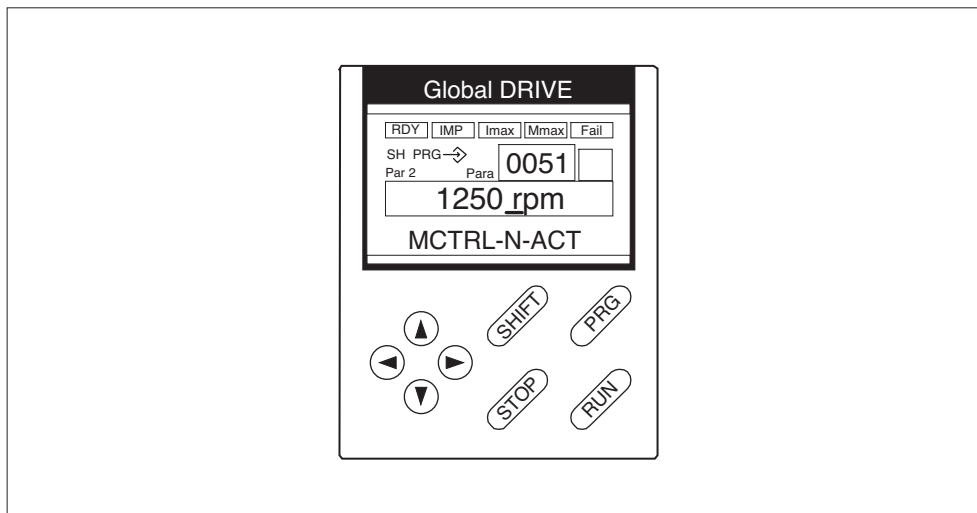

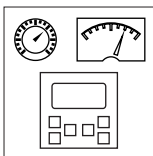

Design - 8200

Plug-in modules

PTC module EMZ 8274IB

A PTC probe or thermal contact (NC contact) is very often used in three-phase AC motors to monitor winding temperatures. This motor protection can be evaluated directly by the frequency inverter via the PTC module.

When activated, the inverter triggers an error message which can for example be evaluated via a TRIP relay. This input is integrated as standard on 8241-8246 and 8221-8227 frequency inverters.

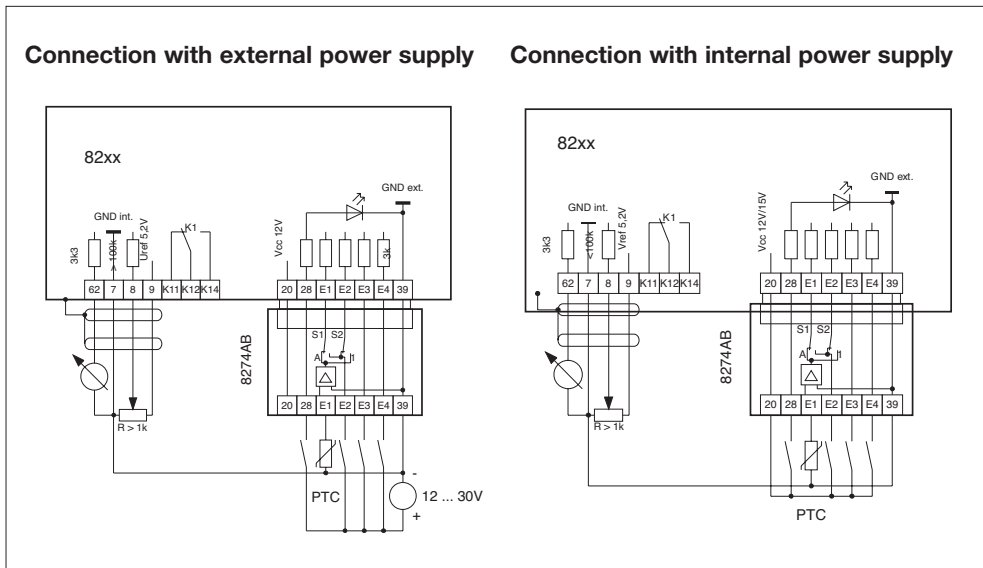

I/O module EMZ 8275IB

The I/O module enables the frequency inverter to perform additional functions. This module is connected in place of the operating unit and features the following functions:

- PTC input for motor temperature monitoring (function as 8274)
- 3 digital output terminals for functions (e.g.):
 Brake control via Q min signal
 Operating indicator for pulse inhibit
 Freely programmable output

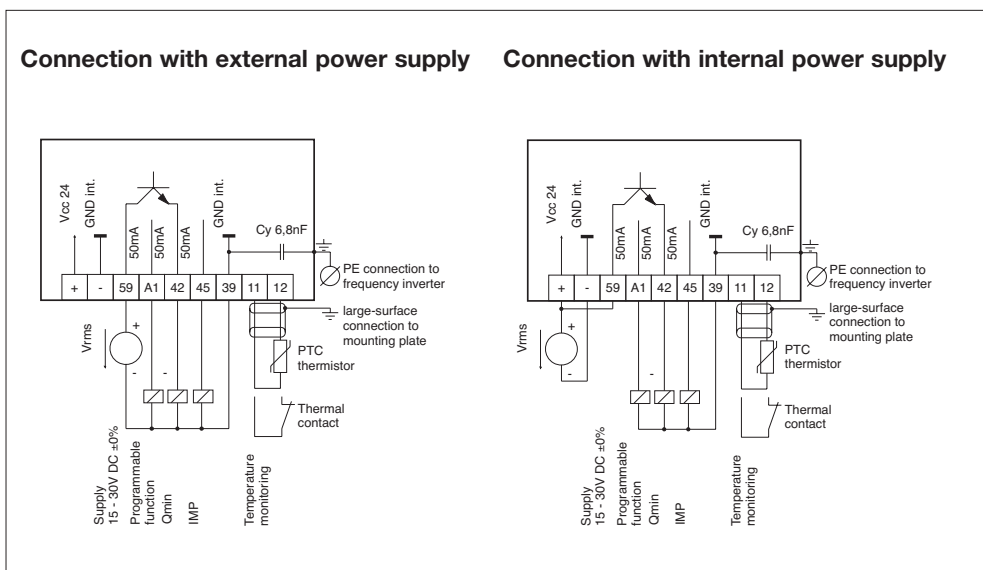

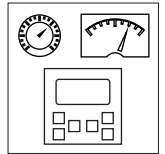

EMZ 8276IB monitor module

As standard, the 8200 frequency inverter has a 0 - 6 V analog output. If this output is not used as an indicator but is required in another controller, a 0 - 10 V voltage is often required.

The output voltage is converted as necessary by the monitor module.

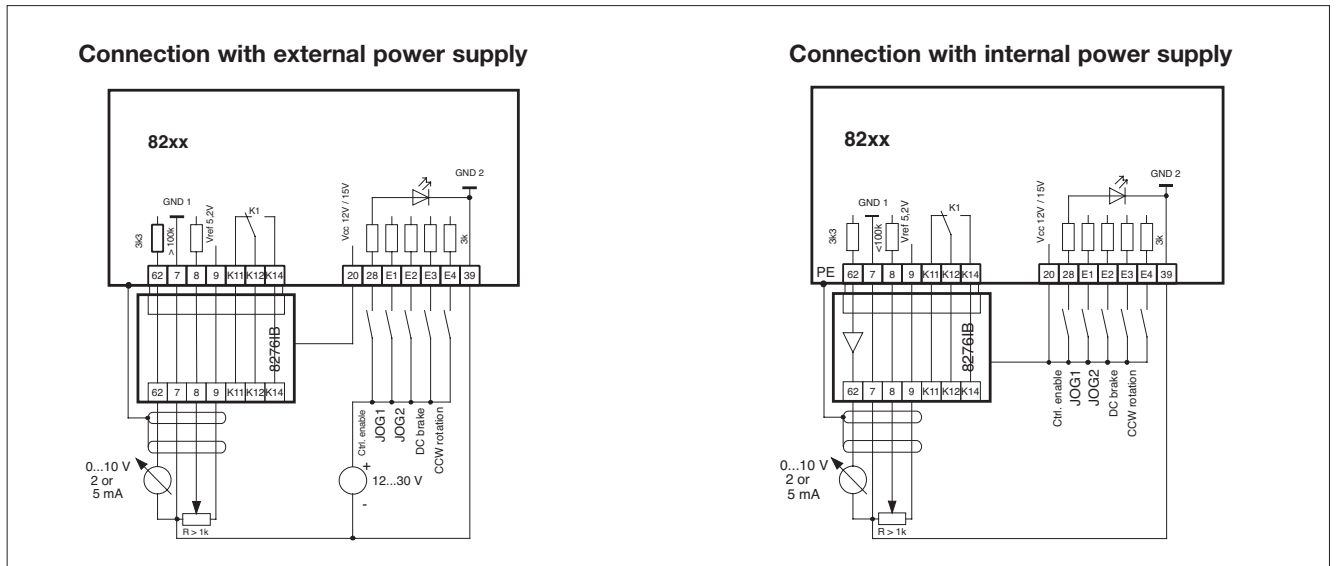

EMZ 8278IB bipolar input module

In some applications, the setpoint and direction of rotation are preset via a bipolar voltage ± 10 V. The bipolar analog module can be used to connect this voltage directly.

This enables a direct connection to be established between the open-loop control and the controller. This solution can be particularly useful in transportation and material handling applications.

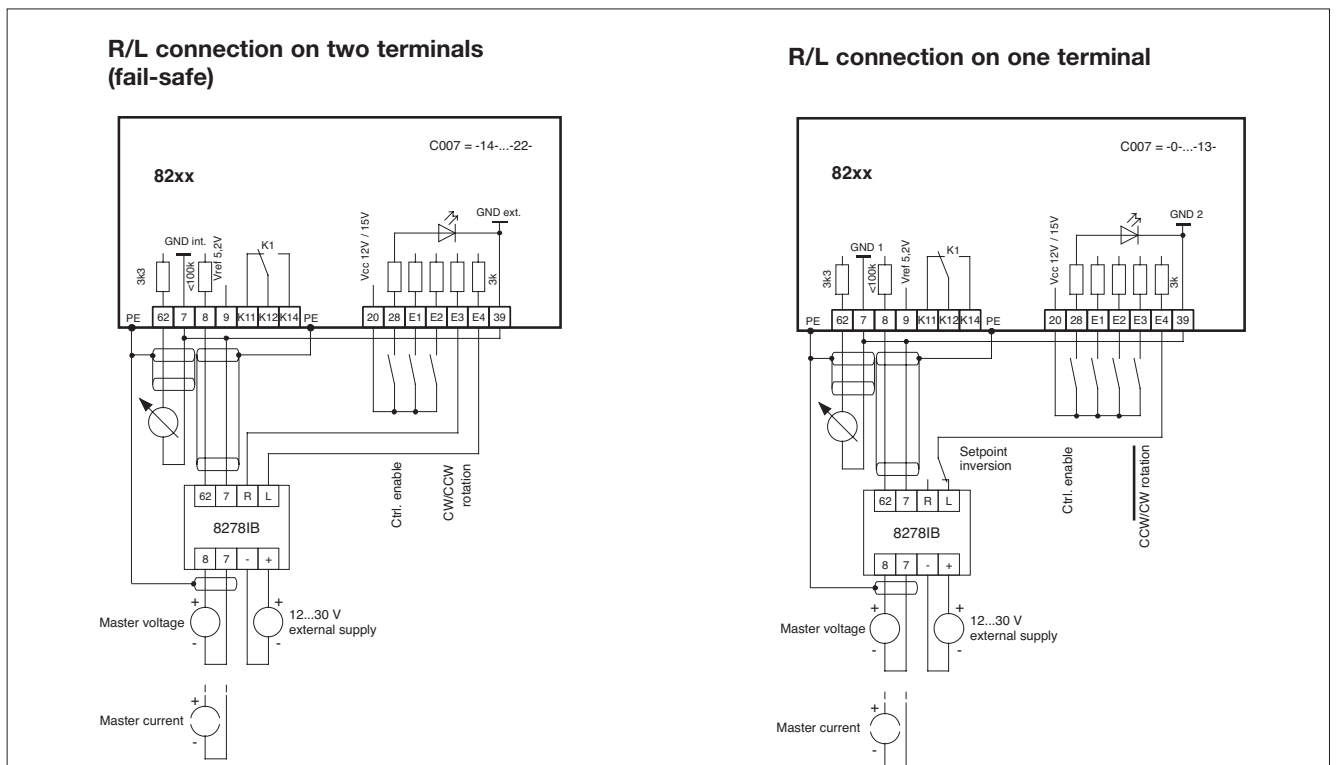

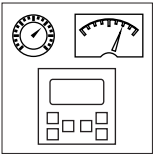

Design - 9300 vector

System bus components

2173IB PC system bus converter

The PC system bus converter can be used to set the parameters of the 9300 inverter via the system bus. This tool can be used for PC access to device data even if a fieldbus module is connected.



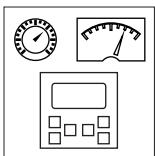

Design - 8200 and 9300 vector

Setpoint potentiometer

Setpoint potentiometer for 8200 frequency inverter

Speed can be preselected through an external potentiometer (setpoint preselection or field frequency preselection).

The setpoint potentiometer is connected to terminals 7, 8 and 9. A scale and a rotary knob are also available.

Name	Order ref.	Data	Dimensions
Setpoint potentiometer	ERPD0001k0001W	1 k Ω /1 Watt	6 mm x 35 mm
Rotary knob	ERZ0001		36 mm diameter
Scale	ERZ0002	0...100 %	62 mm diameter



Setpoint potentiometer for 9300 vector frequency inverter

Speed can be preselected through an external potentiometer (setpoint preselection or field frequency preselection).

The setpoint potentiometer is connected to terminals 7, 8 and 9. A scale and a rotary knob are also available.

Name	Order ref.	Data	Dimensions
Setpoint potentiometer	ERPD0010k0001W	10 k Ω /1 Watt	6 mm x 35 mm
Rotary knob	ERZ0001		36 mm diameter
Scale	ERZ0002	0...100 %	62 mm diameter



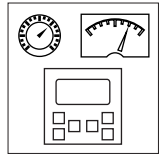

Digital display

A voltmeter can be connected to the monitor outputs to display the output frequency or the motor speed.

Name	Type	Measuring ranges	Mounting cut-out	Mounting depth
Voltmeter 3 1/2 digits	EPD203	0 - 6 V 0 - 20 V 0 - 200 V	91 mm x 22.5 mm	81.5 mm



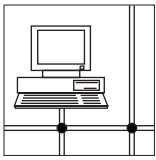

Design - 8200

Communication with a host system

Networking via the RS 232/485 interface

Attachable modules provide an easy way of networking 82XX frequency inverters e.g. with an RS 232 or RS 485 interface on a host system (PLC or PC). The modules are attached in place of the operating module. Three versions are available:

- 2102IBV001: RS 232/485 interface
 - 2102IBV002: RS 485 interface
- The RS 232 and RS 485 interfaces have been designed as 9-pin SUB-D connectors. On the RS 485 interface, there is an additional screw terminal for connecting through to the next drive.
- 2102IBV003: Optical fibres
- Networking via optical fibres (using a plastic core) is completely noise-free and very economical. The optical fibre can be easily adapted through an optical fibre socket at the module. For the host system we offer simple 2125IB plug-on optical fibre adapters which are attached to the interface of the communication module on your PLC.

All three interfaces communicate using the Lenze LECOM protocol. The LECOM protocol is completely open for your own applications. It is however also already integrated in various systems (e.g. Simatic S5), offering a simple option for integration into a control system. Lenze Global Drive Control 1 software can be used for parameter setting.

Networking via a system bus (CAN)

The 2171IB and 2172IB system bus modules are slave modules with the communication module to CIA DS 301. These modules can be used to preselect and read out all of the parameters of the drive. Process data can be transmitted directly in conjunction with a small control system.

The 2172IB system bus module can be used to preset the data transmission speed and the addressing (via program switches) for the drive controller. This module is particularly useful for servicing applications.

Networking via host systems with high processing speeds

- InterBus-S module 2111IB
- The InterBus-S link via the 2111 module is connected directly to the remote bus. The DRIVECOM profile 21 is supported for this connection. A 9-pin SUB-D connector is used for this extremely user-friendly way of networking a drive controller. A 15 V connection for an external power supply to the remote bus is also available on the module.
- Profibus module 2131IB
- The PROFIBUS-DP function module is a slave connection module with the PROFIBUS-DP communication profile. This module can simply be attached in the same way as the other fieldbus module. It is an interesting way of connecting to a process with average process dynamics.



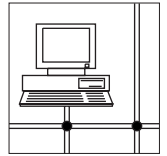

Networking via the RS 232/485 interface

Attachable modules provide an easy way of networking 9300 range devices e.g. with an RS 232 or RS 485 interface on a host system (PLC or PC). The modules are attached in place of the operating module. Three versions are available:

- 2102IBV001: RS 232/485 interface
 - 2102IBV002: RS 485 interface
 - 2102IBV003: Optical fibres
- The RS 232 and RS 485 interfaces have been designed as 9-pin SUB-D connectors. On the RS 485 interface, there is an additional screw terminal for connecting through to the next drive. We recommend the addition of the 2101IB level converter for electrical isolation on the host.
- Networking via optical fibres (using a plastic core) is completely noise-free and very economical. The optical fibre can be easily adapted through an optical fibre socket at the module. For the host system we offer simple 2125IB plug-on optical fibre adapters which are attached to the interface of the communication module on your PLC.

All three interfaces communicate using the Lenze LECOM protocol. The LECOM protocol is completely open for your own applications. It is however also already integrated in various systems (e.g. Simatic S5), offering a simple option for integration into a control system. Lenze Global Drive Control 3 software can be used for parameter setting.

Networking via a system bus (CAN)

All of the drive controller parameters can be preselected and read out. Process data can be transmitted directly in conjunction with a small control system.

Networking via host systems with high processing speeds

- InterBus-S module 2111IB
 - Profibus module 2131IB
- The InterBus-S link via the 2111 module is connected directly to the remote bus. The DRIVECOM profile 21 is supported for this connection. A 9-pin SUB-D connector is used for this extremely user-friendly way of networking a drive controller. A 15 V connection for an external power supply to the remote bus is also available on the module.
- The PROFIBUS-DP function module is a slave connection module with the PROFIBUS-DP communication profile. This module can simply be attached in the same way as the other fieldbus module. It is an interesting way of connecting to a process with average process dynamics. An external 24 V power supply can be used to maintain bus operation.

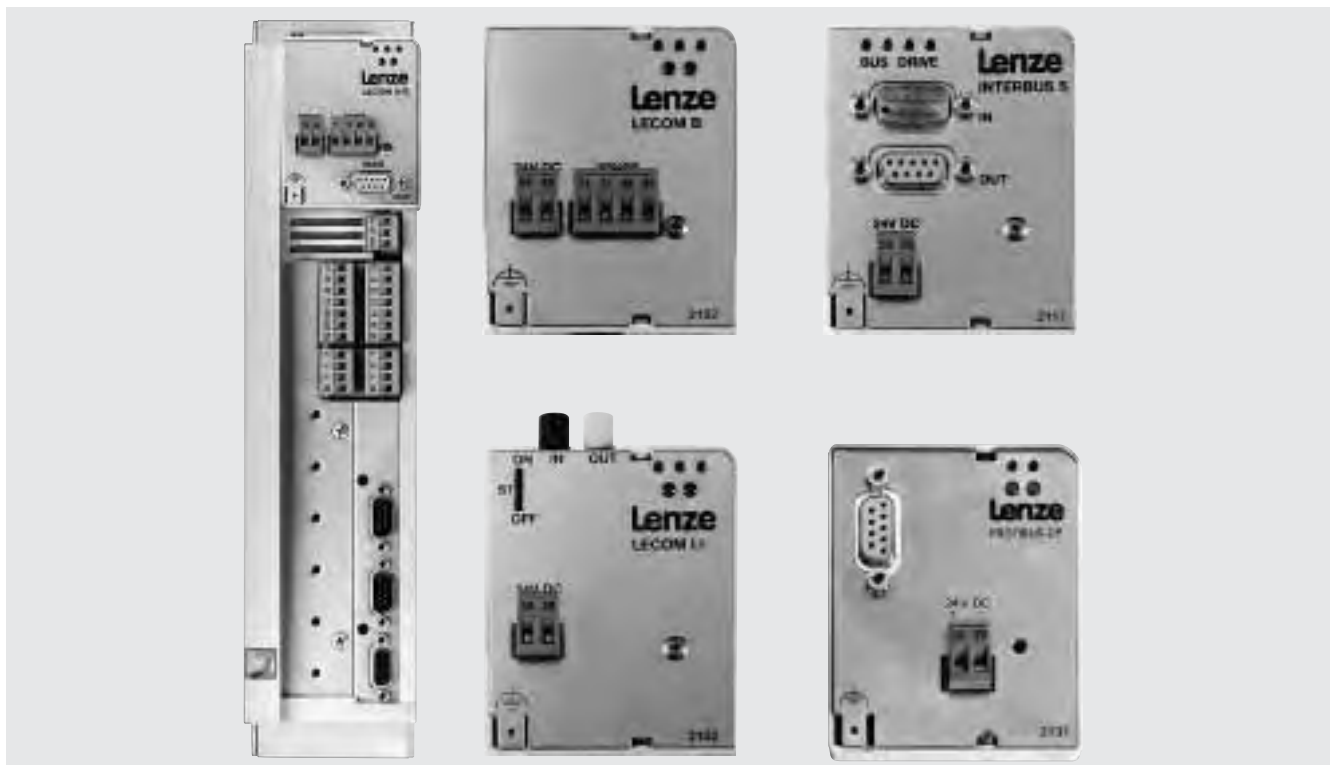

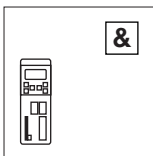

Design - 8200

Overview of accessories

Accessories for all types

Name	Order ref.
8201BB operating module	EMZ8201BB
Diagnosis terminal (2.5 m cable)	EMZ8272BB-V001
Diagnosis terminal (5.0 m cable)	EMZ8272BB-V002
Diagnosis terminal (10 m cable)	EMZ8272BB-V003
Digital display	EPD203
Setpoint potentiometer	ERPD0001k0001W
Rotary knob for potentiometer	ERZ0001
Scale for potentiometer	ERZ0002
RS232/485 fieldbus module	EMF2102IB-V001
RS485 fieldbus module	EMF2102IB-V002
Level converter for RS485	EMF2101IB
PC system cable RS232/485	EWL0020
PC program for Global Drive controller	ESP-GDC2 (GDCeasy: ESP-GDC2-E)
Optical fibre fieldbus module	EMF2102IB-V003
Optical fibre adapter for PLC 0...40 m	EMF2125IB
Power supply for optical fibre adapter 2125	EJ0013
InterBus-S module	EMF2111IB
PROFIBUS module	EMF2131IB
System bus module with addressing	EMF2172IB
System bus module (CAN)	EMF2171IB
PTC module	EMZ8274IB
I/O module	EMZ8275IB
Monitor module	EMZ8276IB
Bipolar setpoint module	EMZ8278IB
Analog input module	EMZ8279IB

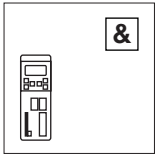

Type-specific accessories 8201 to 8204

Name	Order ref.			
	8201	8202	8203	8204
Automatic circuit-breaker	EFA1C10A	EFA1C16A	EFA1C20A	EFA1C20A
Fuse	EFSM-0100ASB	EFSM-0150ASB	EFSM-0200ASC	EFSM-0200ASC
Fuse holder	EFH30001	EFH30001	EFH30001	EFH30001
Mains filter type "A"	EZN2-004A001	EZN2-008A001	EZN2-013A001	EZN2-017A001
Mains choke	ELN1-0900H005	ELN1-0500H009	ELN1-0350H014	ELN1-0160H017
RFI filter for operation with mains choke without mains choke	EZF1-006A002 EZF1-006A002	EZF1-009A002 EZF1-009A002	EZF1-018A002 EZF1-018A002	EZF1-018A002 Not permitted
Motor filter	ELM3-030H003	ELM3-020H004	ELM3-010H010	ELM3-014H010
Sinusoidal filter	EZS3-003A001	EZS3-004A002	EZS3-007A001	EZS3-010A001
Brake module	EMB8251-E	EMB8251-E	EMB8251-E	EMB8251-E
Swivel wall fastening	EJ0001	EJ0001	EJ0001	EJ0002
DIN rail mounting	EJ0002	EJ0002	EJ0002	EJ0002
Fan for surface mounting	EJ0003	EJ0003	EJ0003	EJ0003
Current limiting module	EMZ8201AB	EMZ8201AB	EMZ8203AB	EMZ8203AB



Design - 8200

Overview of accessories

Type-specific accessories 8211 to 8218 at 150% overload

Name	Order ref.			
	8211	8212	8213	8214
Automatic circuit-breaker*	EFA3B06A	EFA3B06A	EFA3B10A	EFA3B10A
Fuse	EFSM-0060AWE	EFSM-0060AWE	EFSM-0100AWE	EFSM-0100AWE
Fuse holder	EFH10001	EFH10001	EFH10001	EFH10001
Mains filter type B	EZN3B1500H003	EZN3B0800H004	EZN3B0750H005	EZN3B0500H007
Mains choke	ELN3-0700H003	ELN3-0450H004	ELN3-0350H006	ELN3-0250H007
RFI filter* for operation with mains choke	EZF3-008A003	EZF3-008A003	EZF3-008A003	EZF3-008A003
without mains choke	EZF3-008A003	EZF3-008A003	EZF3-008A003	Not permitted
Motor filter	ELM3-030H004	ELM3-030H004	ELM3-014H010	ELM3-014H010
Sinusoidal filter	EZS3-002A001	EZS3-004A002	EZS3-006A001	EZS3-007A001
Brake module	EMB8252-E	EMB8252-E	EMB8252-E	EMB8252-E
Brake chopper	EMB8253-E	EMB8253-E	EMB8253-E	EMB8253-E
Brake resistor	ERBM470R100W	ERBM370R150W	ERBM240R200W	ERBD180R300W
Swivel wall fastening	EJ0001	EJ0001	EJ0001	EJ0001
DIN rail mounting	EJ0002	EJ0002	EJ0002	EJ0002

Name	Order ref.			
	8215	8216	8217	8218
Automatic circuit-breaker*	EFA3B13A	EFA3B20A	EFA3B25A	EFA3B32A
Fuse	EFSM-0160AWE	EFSM-0200AWE	EFSM-0250AXH	EFSM-0320AWH
Fuse holder	EFH10001	EFH10001	EFH10002	EFH10002
Mains filter type B	EZN3B0400H009	EZN3B0300H013	EZN3B0250H015	EZN3B0150H024
Mains choke	ELN3-0160H012	ELN3-0160H012	ELN3-0120H017	ELN3-0120H025
RFI filter* for operation with mains choke	EZF3-016A003	EZF3-016A003	EZF3-016A003	EZF3-024A001
without mainschoke	EZF3-016A003	EZF3-024A001	EZF3-024A001	Not permitted
Motor filter	ELM3-014H010	ELM3-007H025	ELM3-007H025	ELM3-007H025
Sinusoidal filter	EZS3-010A002	EZS3-013A001	EZS3-017A001	EZS3-024A001
Brake module	EMB8252-E	EMB8252-E	EMB8252-E	EMB8252-E
Brake chopper	EMB8253-E	EMB8253-E	EMB8253-E	EMB8253-E
Brake resistor	ERBD100R600W	ERBD082R600W	ERBD068R800W	ERBD047R01k2
Thermal separation ("push-through technology")	EJ0004	EJ0004	EJ0004	EJ0004
Heatsink with mounting kit only for version V003	EJ0005	EJ0005	EJ0005	EJ0005

* Operation at 400 V mains voltage

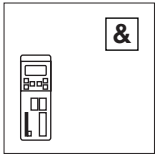

Type-specific accessories 8211 to 8218 at 120% overload

Name	Order ref.			
	8211	8212	8213	8214
Automatic circuit-breaker*	EFA3B06A	EFA3B06A	EFA3B10A	EFA3B10A
Fuse	EFSM-0060AWE	EFSM-0060AWE	EFSM-0100AWE	EFSM-0100AWE
Fuse holder	EFH10001	EFH10001	EFH10001	EFH10001
Mains filter type B	EZN3B0900H004	EZN3B0900H004	EZN3B0350H007	EZN3B0350H007
Mains choke	ELN3-0450H004	ELN3-0450H004	ELN3-0250H007	ELN3-0250H007
RFI filter* for operation with mains choke	EZF3-008A003	EZF3-008A003	EZF3-008A003	EZF3-008A003
Motor filter	ELM3-030H004	ELM3-030H004	ELM3-014H010	ELM3-014H010
Sinusoidal filter	EZS3-004A002	EZS3-004A002	EZS3-007A001	EZS3-007A001
Brake module	EMB8252-E	EMB8252-E	EMB8252-E	EMB8252-E
Brake chopper	EMB8253-E	EMB8253-E	EMB8253-E	EMB8253-E
Brake resistor	ERBM470R100W	ERBM370R150W	ERBM240R200W	ERBD180R300W
Swivel wall fastening	EJ0001	EJ0001	EJ0001	EJ0001
DIN rail mounting	EJ0002	EJ0002	EJ0002	EJ0002

Name	Order ref.			
	8215	8216	8217	8218
Automatic circuit-breaker*	EFA3B20A	EFA3B20A	EFA3B32A	EFA3B32A
Fuse	EFSM-0200AWE	EFSM-0200AWE	EFSM-0320AWH	EFSM-0320AWH
Fuse holder	EFH10001	EFH10001	EFH10002	EFH10002
Mains filter type B	EZN3B0300H013	EZN3B0300H013	EZN3B0120H021	EZN3B0150H024
Mains choke	ELN3-0160H012	ELN3-0160H012	ELN3-0120H025	ELN3-0120H025
RFI filter* for operation with mains choke	EZF3-016A003	EZF3-016A003	EZF3-024A001	EZF3-024A001
Motor filter	ELM3-007H025	ELM3-007H025	ELM3-007H025	ELM3-007H025
Sinusoidal filter	EZS3-013A001	EZS3-013A001	EZS3-024A001	EZS3-024A001
Brake module	EMB8252-E	EMB8252-E	EMB8252-E	EMB8252-E
Brake chopper	EMB8253-E	EMB8253-E	EMB8253-E	EMB8253-E
Brake resistor	ERBD100R600W	ERBD082R600W	ERBD068R800W	ERBD047R01k2
Thermal separation ("push-through technology")	EJ0004	EJ0004	EJ0004	EJ0004
Heatsink with mounting kit only for version V003	EJ0005	EJ0005	EJ0005	EJ0005

* Operation at 400 V mains voltage

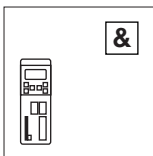

Design - 8200

Overview of accessories

Type-specific accessories 8241 to 8246 at 150% overload

Name	Order ref.			
	8241	8242	8243	8244
Automatic circuit breaker*	EFA3B06A	EFA3B06A	EFA3B10A	EFA3B10A
Fuse	EFSM-0060AWE	EFSM-0060AWE	EFSM-0100AWE	EFSM-0100AWE
Fuse holder	EFH10001	EFH10001	EFH10001	EFH10001
Mains filter type A	EZN3A2400H002	EZN3A1500H003	EZN3A0900H004	EZN3A0500H007
Mains filter type B	EZN3B2400H002	EZN3B1500H003	EZN3B0900H004	EZN3B0500H007
Motor filter	ELM3-030H004	ELM3-030H004	ELM3-003H004	ELM3-014H010
Sinusoidal filter	EZS3-002A001	EZS3-002A001	EZS3-004A002	EZS3-007A001
Brake module	EMB9351-E	EMB9351-E	EMB9351-E	EMB9351-E
Brake chopper	EMB9352-E	EMB9352-E	EMB9352-E	EMB9352-E
Brake resistor	ERBM470R050W	ERBM470R100W	ERBM370R150W	ERBD180R300W
Thermal separation (push-through technology)	EJ0036	EJ0036	EJ0037	EJ0037

Name	Order ref.			
	8245	8246		
Automatic circuit breaker*	EFA3B20A	EFA3B32A		
Fuse	EFSM-0200AWE	EFSM-0320AWH		
Fuse holder	EFH10001	EFH10002		
Mains filter type A	EZN3A0300H013	EZN3B0300H013		
Mains filter type B	EZN3B0300H013	ELN3-0160H012		
Motor filter	ELM3-007H025	ELM3-007H025		
Sinusoidal filter	EZS3-013A001	EZS3-024A001		
Brake module	EMB9351-E	EMB9351-E		
Brake chopper	EMB9352-E	EMB9352-E		
Brake resistor	ERBD100R600W	ERBD047R01k2		
Thermal separation (push-through technology)	EJ0038	EJ0038		

* Operation at 400 V mains voltage

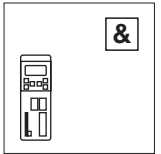

Type-specific accessories 8241 to 8246 at 120% overload

Name	Order ref.			
	8241	8242	8243	8244
Automatic circuit breaker*	EFA3B06A	EFA3B10A	EFA3B10A	EFA3B13A
Fuse	EFSM-0060AWE	EFSM-0100AWE	EFSM-0100AWE	EFSM-0160AWE
Fuse holder	EFH10001	EFH10001	EFH10001	EFH10001
Mains filter type A	EZN3A2400H002	EZN3A1500H003	EZN3A0750H005	EZN3A0400H009
Mains filter type B	EZN3B2400H002	EZN3B1500H003	EZN3B0750H005	EZN3B0400H009
Motor filter	ELM3-030H004	ELM3-014H010	ELM3-014H010	ELM3-014H010
Sinusoidal filter	EZS3-002A001	EZS3-004A002	EZS3-006A001	EZS3-008A001
Brake module	EMB9351-E	EMB9351-E	EMB9351-E	EMB9351-E
Brake chopper	EMB9352-E	EMB9352-E	EMB9352-E	EMB9352-E
Brake resistor	ERBM470R050W	ERBM470R100W	ERBM370R150W	ERBD180R300W
Thermal separation (push-through technology)	EJ0036	EJ0037	EJ0037	EJ0037

Name	Order ref.		
	8245	8246	
Automatic circuit breaker*	EFA3B20A	EFA3B32A	
Fuse	EFSM-0200AWE	EFSM-0320AWH	
Fuse holder	EFH10001	EFH10002	
Mains filter type A	EZN3A0300H013	EZN3A0150H024	
Mains filter type B	EZN3B0250H015	ELN3B0150H024	
Motor filter	ELM3-0150H024	ELM3-0150H024	
Sinusoidal filter	EZS3-017A001	EZS3-024A001	
Brake module	EMB9351-E	EMB9351-E	
Brake chopper	EMB9352-E	EMB9352-E	
Brake resistor	ERBD100R600W	ERBD047R01k2	
Thermal separation (push-through technology)	EJ0038	EJ0038	

* Operation at 400 V mains voltage



Design - 8200

Overview of accessories

Type-specific accessories 8221 to 8227 at 150% overload

Name	Order ref.			
	8221	8222	8223	8224
Mains filter type A	EZN3A0110H030	EZN3A0080H042	EZN3A0055H060	EZN3A0037H090
Mains filter type B	EZN3B0110H030	EZN3B0080H042	EZN3B0055H060	EZN3B0037H090
Mains choke	ELN3-088H035	ELN3-0075H045	ELN3-0055H055	ELN3-0038H085
Motor filter	ELM3-004H055	ELM3-004H055	on request	on request
Sinusoidal filter	on request	on request	on request	on request
Brake module	EMB9351-E	EMB9351-E	EMB9351-E	EMB9351-E
Brake chopper	EMB9352-E	EMB9352-E	EMB9352-E	EMB9352-E (2 x)
Brake resistor	ERBD033R02k0	ERBD022R03k0	ERBD018R03k0	ERBD022R03k0 (2 x)
Thermal separation	EJ0011	EJ0011	EJ0011	EJ0010

Name	Order ref.		
	8225	8226	8227
Mains filter type A	EZN3A0030H110	EZN3A0022H150	EZN3A0017H200
Mains filter type B	EZN3B0030H110	EZN3B0022H150	EZN3B0017H200
Mains choke	ELN3-0027H105	ELN3-0022H130	ELN3-0017H170
Motor filter	on request	on request	on request
Sinusoidal filter	on request	on request	on request
Brake module	EMB9351-E	EMB9351-E	EMB9351-E
Brake chopper	EMB9352-E (2 x)	EMB9352-E (3 x)	EMB9352-E (3 x)
Brake resistor	ERBD018R03k0 (2 x)	ERBD022R03k0 (3 x)	ERBD018R03k0 (3 x)
Thermal separation	EJ0010	EJ0009	EJ0009

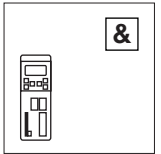

Type-specific accessories 8221 to 8227 at 120% overload

Name	Order ref.			
Device	8221	8222	8223	8224
Mains filter type A	EZN3A0080H042	EZN3A0060H054	EZN3A0055H060	EZN3A0030H110
Mains filter type B	EZN3B0080H042	EZN3B0060H054	EZN3B0055H060	EZN3B0030H110
Mains choke	ELN3-0075H045	ELN3-0055H055	ELN3-0055H055	ELN3-0027H105
Motor filter	ELM3-004H055	on request	on request	on request
Sinusoidal filter	on request	on request	on request	on request
Brake module	EMB9351-E	EMB9351-E	EMB9351-E	EMB9351-E
Brake chopper	EMB9352-E	EMB9352-E	EMB9352-E (2 x)	EMB9352-E (2 x)
Brake resistor	ERBD033R02k0	ERBD022R03k0	ERBD018R03k0 (2 x)	ERBD022R03k0 (2 x)
Thermal separation	EJ0011	EJ0011	EJ0011	EJ0010

Name	Order ref.		
Device	8225	8226	8227
Mains filter type A	EZN3A0030H110	EZN3A0022H150	EZN3A0017H200
Mains filter type B	EZN3B0030H110	EZN3B0022H150	EZN3B0017H200
Mains choke	ELN3-0022H130	ELN3-0017H170	ELN3-0014H200
Motor filter	on request	on request	on request
Sinusoidal filter	on request	on request	on request
Brake module	EMB9351-E	EMB9351-E	EMB9351-E
Brake chopper	EMB9352-E (2 x)	EMB9352-E (3 x)	EMB9352-E (3 x)
Brake resistor	ERBD018R03k0 (2 x)	ERBD022R03k0 (3 x)	ERBD018R03k0 (3 x)
Thermal separation	EJ0010	EJ0009	EJ0009

Type-specific accessories 9341-9343

Name	Order ref.		
Device	9341	9342	9343
Mains filter type A	EZN3A120H012	EZN3A0088H024	EZN3A0055H045
Thermal separation (push-through technology)	EJ0038	EJ0038	EJ0011



Design - 9300 vector

Overview of accessories

Accessories	Designation	Order ref.	
Communication modules	LECOM-LI (optical fibres)	EMF2102IB-V003	
	LECOM-B (RS485)	EMF2102IB-V002	
	LECOM-A/B (RS232/485)	EMF2102IB-V001	
	LON	EMF2141IB	
	INTERBUS	EMF2113IB	
	INTERBUS Loop	EMF2112IB	
	PROFIBUS-DP	EMF2133IB	
	DeviceNet/CANopen	EMF2175IB	
	Keypad XT operating module	EMZ9371BC	
	Diagnosis terminal (hand-held Keypad XT, IP20 ¹)	E82ZBBXC	
Miscellaneous	Connection cable	2.5 m	E82ZWL025
		5 m	E82ZWL050
		10 m	E82ZWL100
	"Global Drive Control" (GDC) parameter setting/operating software	ESP-GDC2	
	PC system bus converter (voltage supply via DIN connection)	EMF2173IB	
	PC system bus converter (voltage supply via PS2 connection)	EMF2173IB-V002	
	PC system bus converter (voltage supply via PS2 connection; electrical isolation)	EMF2173IB-V003	
	PC system bus converter USB	EMF2177IB	
	PC system cable RS232	5 m	EWL0020
		10 m	EWL0021
	Optical fibre adapter (normal transmission rating)	EMF2125IB	
	Optical fibre adapter (high transmission rating)	EMF2126IB	
	Power supply for optical fibre adapter	EJ0013	
	Optical fibre, 1-wire, black PE sleeve (simple protection), sold by the metre	EWZ0007	
	Optical fibre, 1-wire, red PUR sleeve (reinforced protection), sold by the metre	EWZ0006	
	Setpoint potentiometer	ERPD0010K0001W	
	Rotary knob for setpoint potentiometer	ERZ0001	
	Scale for setpoint potentiometer	ERZ0002	
	Digital display	EPD203	
	Encoder cable	2.5 m	EWLE002GX-T
		5.0 m	EWLE005GX-T
		10.0 m	EWLE010GX-T
		15.0 m	EWLE015GX-T
		20.0 m	EWLE020GX-T
		25.0 m	EWLE025GX-T
		30.0 m	EWLE030GX-T
		35.0 m	EWLE035GX-T
		40.0 m	EWLE040GX-T
		45.0 m	EWLE045GX-T
		50.0 m	EWLE050GX-T
	Connection cable for a master frequency connection (2.5 m)	EWLD002GGBS93	

¹⁾ Additional connection cable required



Accessories	Designation	Order ref.
Communication manual CAN ¹⁾	German	EDSCAN
	English	
	French	
Communication manual INTERBUS ¹⁾	German	EDSIBUS
	English	
	French	
Communication manual PROFIBUS ¹⁾	German	EDSPBUS
	English	
	French	
Communication manual LECOM ¹⁾	German	EDSLECOM
	English	
	French	
Communication manual DeviceNet ¹⁾	German	EDSDEN
	English	
	French	

¹⁾ Please specify the required language when ordering documentation.

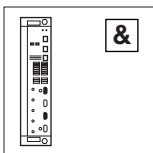

Design - 9300 vector

Overview of accessories

Type-specific accessories 9321EV to 9326EV at 120% overload

Name	Order ref.			
	EVF9321EV	EVF9322EV	EVF9323EV	EVF9324EV
Automatic circuit breaker*	EFA3B06A	EFA3B06A	EFA3B10A	EFA3B13A
Fuse	EFSM-0060AWE	EFSM-0060AWE	EFSM-0100AWE	EFSM-0160AWE
Fuse holder	EFH10001	EFH10001	EFH10001	EFH10001
Mains filter type A	EZN3A2400H002	EZN3A1500H003	EZN3A0750H005	EZN3A0400H009
Mains filter type B	EZN3B2400H002	EZN3B1500H003	EZN3B0750H005	EZN3B0400H009
Motor filter	ELM3-030H004	ELM3-030H004	ELM3-014H010	ELM3-007H025
Sinusoidal filter	EZS3-002A001	EZS3-004A002	EZS3-006A001	EZS3-009A002
Brake module	EMB9351-E	EMB9351-E	EMB9351-E	EMB9351-E
Brake chopper	EMB9352-E	EMB9352-E	EMB9352-E	EMB9352-E
Brake resistor	ERBM470R050W	ERBM470R100W	ERBM370R150W	ERBD180R300W
Thermal separation (push-through technology)	EJ0036	EJ0037	EJ0037	EJ0037

Name	Order ref.		
	EVF9325EV	EVF9326EV	
Automatic circuit breaker*	EFA3B20A	EFA3B32A	
Fuse	EFSM-0200AWE	EFSM-0320AWH	
Fuse holder	EFH10001	EFH10002	
Mains filter type A	EZN3A0300H013	EZN3A0150H024	
Mains filter type B	EZN3B0250H015	EZN3B0150H024	
Motor filter	ELM3-007H025	ELM3-007H025	
Sinusoidal filter	EZS3-017A001	EZS3-024A001	
Brake module	EMB9351-E	EMB9351-E	
Brake chopper	EMB9352-E	EMB9352-E	
Brake resistor	ERBD100R600W	ERBD047R01k2	
Thermal separation (push-through technology)	EJ0038	EJ0038	

* Operation at 400 V mains voltage

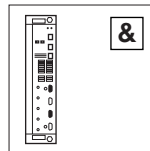

Type-specific accessories 9321 to 9326 at 150% overload

Name	Order ref.			
	EVF9321EV	EVF9322EV	EVF9323EV	EVF9324EV
Automatic circuit breaker*	EFA3B06A	EFA3B06A	EFA3B10A	EFA3B10A
Fuse	EFSM-0060AWE	EFSM-0060AWE	EFSM-0100AWE	EFSM-0100AWE
Fuse holder	EFH10001	EFH10001	EFH10001	EFH10001
Mains filter type A	EZN3A2400H002	EZN3A1500H003	EZN3A0900H004	EZN3A0500H007
Mains filter type B	EZN3B2400H002	EZN3B1500H003	EZN3B0900H004	EZN3B0500H007
Motor filter	ELM3-030H004	ELM3-030H004	ELM3-030H004	ELM3-014H010
Sinusoidal filter	EZS3-002A001	EZS3-002A001	EZS3-004A002	EZS3-007A002
Brake module	EMB9351-E	EMB9351-E	EMB9351-E	EMB9351-E
Brake chopper	EMB9352-E	EMB9352-E	EMB9352-E	EMB9352-E
Brake resistor	ERBM470R050W	ERBM470R100W	ERBM370R150W	ERBD180R300W
Thermal separation (push-through technology)	EJ0036	EJ0036	EJ0037	EJ0037

Name	Order ref.		
	EVF9325EV	EVF9326EV	
Automatic circuit breaker*	EFA3B20A	EFA3B32A	
Fuse	EFSM-0200AWE	EFSM-0320AWH	
Fuse holder	EFH10002	EFH10002	
Mains filter type A	EZN3A0300H013	EZN3A0150H024	
Mains filter type B	EZN3B0300H013	EZN3B0150H024	
Motor filter	ELM3-007H025	ELM3-007H025	
Sinusoidal filter	EZS3-013A001	EZS3-024A001	
Brake module	EMB9351-E	EMB9351-E	
Brake chopper	EMB9352-E	EMB9352-E	
Brake resistor	ERBD100R600W	ERBD047R01k2	
Thermal separation (push-through technology)	EJ0038	EJ0038	

* Operation at 400 V mains voltage

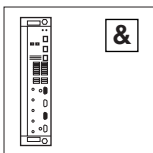

Design - 9300 vector

Overview of accessories

Type-specific accessories 9327EV to 9333EV at 150% overload

Name	Order ref.			
	EVF9327EV	EVF9328EV	EVF9329EV	EVF9330EV
Mains filter type A	EZN3A0110H030	EZN3A0080H042	EZN3A0055H060	EZN3A0037H090
Mains filter type B	EZN3B0110H030	EZN3B0080H042	EZN3B0055H060	EZN3B0037H090
Mains choke	ELN3-0088H035	ELN3-0075H045	ELN3-0055H055	ELN3-0038H085
Motor filter	ELM3-004H055	ELM3-004H055	on request	on request
Sinusoidal filter	on request	on request	on request	on request
Brake module	EMB9351-E	EMB9351-E	EMB9351-E	EMB9351-E
Brake chopper	EMB9352-E	EMB9352-E	EMB9352-E	EMB9352-E (2 x)
Brake resistor	ERBD033R02k0	ERBD022R03k0	ERBD018R03k0	ERBD022R03k0 (2 x)
Thermal separation	EJ0011	EJ0011	EJ0011	EJ0010

Name	Order ref.		
	EVF9331EV	EVF9332EV	EVF9333EV
Mains filter type A	EZN3A0030H110	EZN3A0022H150	EZN3A0017H200
Mains filter type B	EZN3B0030H110	EZN3B0022H150	EZN3B0017H200
Mains choke	ELN3-0027H105	ELN3-0022H130	ELN3-0017H170
Motor filter	on request	on request	on request
Sinusoidal filter	on request	on request	on request
Brake module	EMB9351-E	EMB9351-E	EMB9351-E
Brake chopper	EMB9352-E (2 x)	EMB9352-E (3 x)	EMB9352-E (3 x)
Brake resistor	ERBD018R03k0 (2 x)	ERBD022R03k0 (3 x)	ERBD018R03k0 (3 x)
Thermal separation	EJ0010	EJ0009	EJ0009

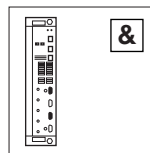

Type-specific accessories 9327 to 9333 at 120% overload

Name	Order ref.			
Device	EVF9327EV	EVF9328EV	EVF9329EV	EVF9330EV
Mains filter type A	EZN3A0080A042	EZN3A0060A054	EZN3A0055H060	EZN3A0030H110
Mains filter type B	EZN3B0080A042	EZN3B0055A060	EZN3B0055H060	EZN3B0030H110
Mains choke	ELN3-0075H045	ELN3-0055H055	ELN3-0055H055	ELN3-0027H105
Motor filter	ELM3-004H055	on request	on request	on request
Sinusoidal filter	on request	on request	on request	on request
Brake module	EMB9351-E	EMB9351-E	EMB9351-E	EMB9351-E
Brake chopper	EMB9352-E	EMB9352-E	EMB9352-E (2 x)	EMB9352-E (2 x)
Brake resistor	ERBD033R02k0	ERBD022R03k0	ERBD018R03k0 (2 x)	ERBD022R03k0 (2 x)
Thermal separation	EJ0011	EJ0011	EJ0011	EJ0010

Name	Order ref.		
Device	EVF9331EV	EVF9332EV	EVF9333EV
Mains filter type A	EZN3A0030H110	EZN3A0022H150	EZN3A0017H200
Mains filter type B	EZN3B0030H110	EZN3B0022H150	EZN3B0017H200
Mains choke	ELN3-0022H130	ELN3-0017H170	ELN3-0014H200
Motor filter	on request	on request	on request
Sinusoidal filter	on request	on request	on request
Brake module	EMB9351-E	EMB9351-E	EMB9351-E
Brake chopper	EMB9352-E (2 x)	EMB9352-E (3 x)	EMB9352-E (3 x)
Brake resistor	ERBD018R03k0 (2 x)	ERBD022R03k0 (3 x)	ERBD018R03k0 (3 x)
Thermal separation	EJ0010	EJ0009	EJ0009

Type-specific accessories 9341-9343

Name	Order ref.		
Device	9341	9342	9343
Mains filter type A	EZN3A120H012	EZN3A0088H024	EZN3A0055H045
Thermal separation (push-through technology)	EJ0038	EJ0038	EJ0011

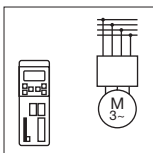

Application examples

Connecting diagrams

Power connection – 820XE frequency inverter

Connection to single-phase mains 1 x 220 ... 230 V

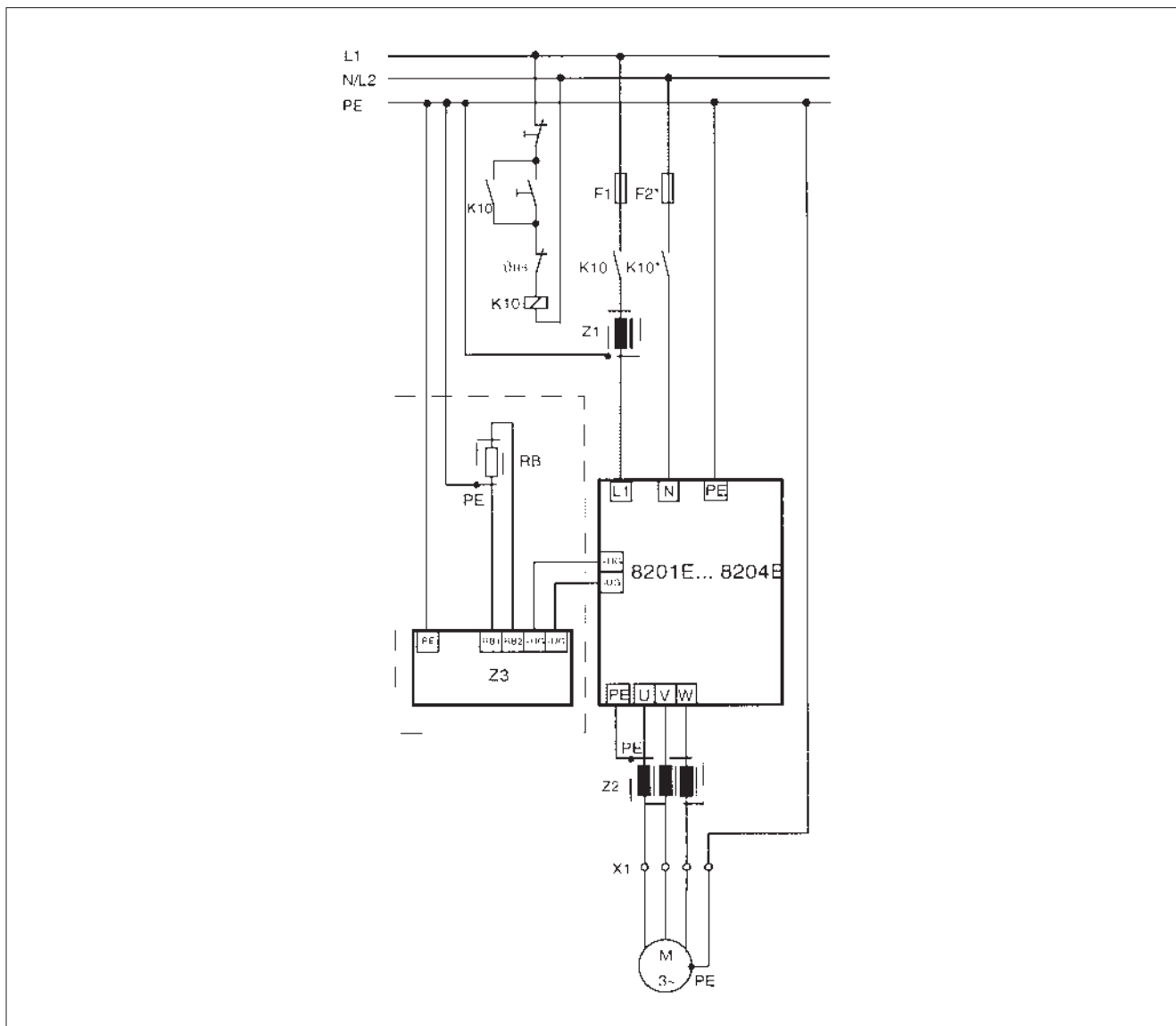

- F1, F2* Line protection, F2* only with 2 AC/PE/190 - 260 V power supply
- K10, K10* Mains contactor, K10* only with 2 AC/PE/190 - 260 V power supply
- Z1 Mains choke/mains filter, see Accessories
Only operate the 8204E with an assigned mains choke/mains filter
- Z2 Motor filter/sinusoidal filter, see Accessories
- Z3 Brake chopper/brake module, see Accessories
- RB Brake resistor, see Accessories
- ∅_{RB} Temperature monitoring for brake resistor
- X1 Terminal strip in control cabinet

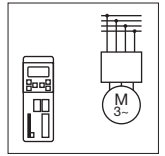

Power connection - 821X, 824X and 822X frequency inverters

Connection to three-phase mains 3 x 400 ... 460 V/480 V

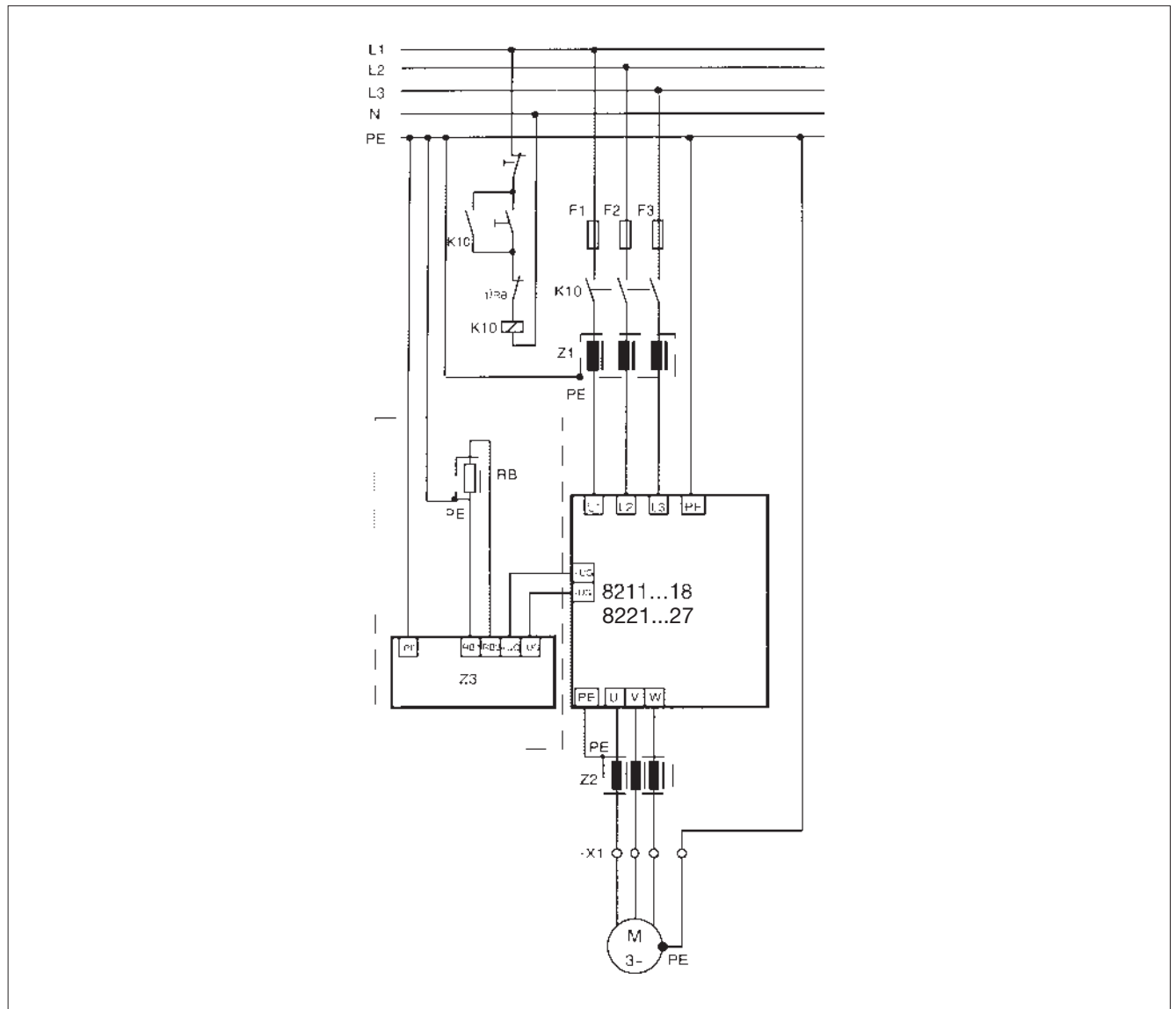

F1, F2, F3 Line protection

K10 Mains contactor

Z1 Mains choke/mains filter, see Accessories

Only operate the 8214E and 8221 to 8227 with an assigned mains choke/mains filter

Z2 Motor filter/sinusoidal filter, see Accessories

Z3 Brake chopper/brake module, see Accessories

RB Brake resistor, see Accessories

ϑ_{RB} Temperature monitoring for brake resistor

-X1 Terminal strip in control cabinet

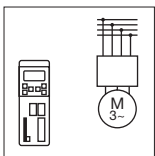

Application examples

Connecting diagrams

Control terminal connections – 820X and 821X frequency inverters

For power supply with internal control voltage

The control connectors have basic insulation (single insulating distances)

If protection against electrical contact is required,

- Double insulation must be implemented
- The components to be connected must be provided with the second isolating distance

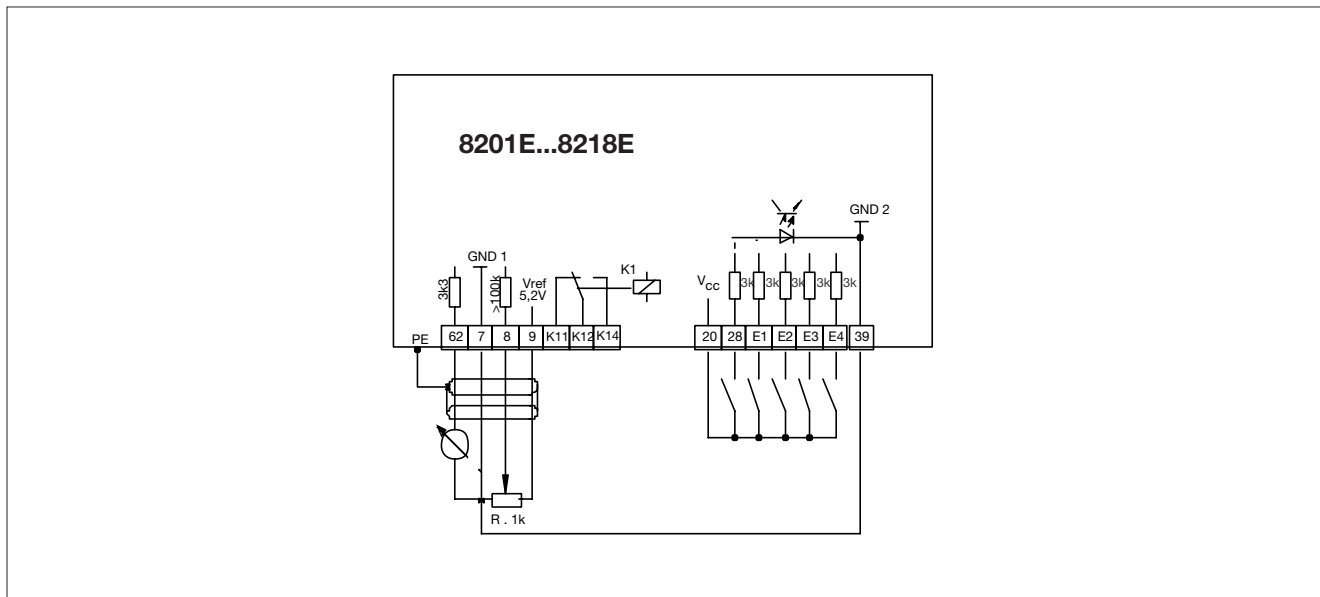

If the power is being supplied by an external control voltage (+12 ...+30 V)

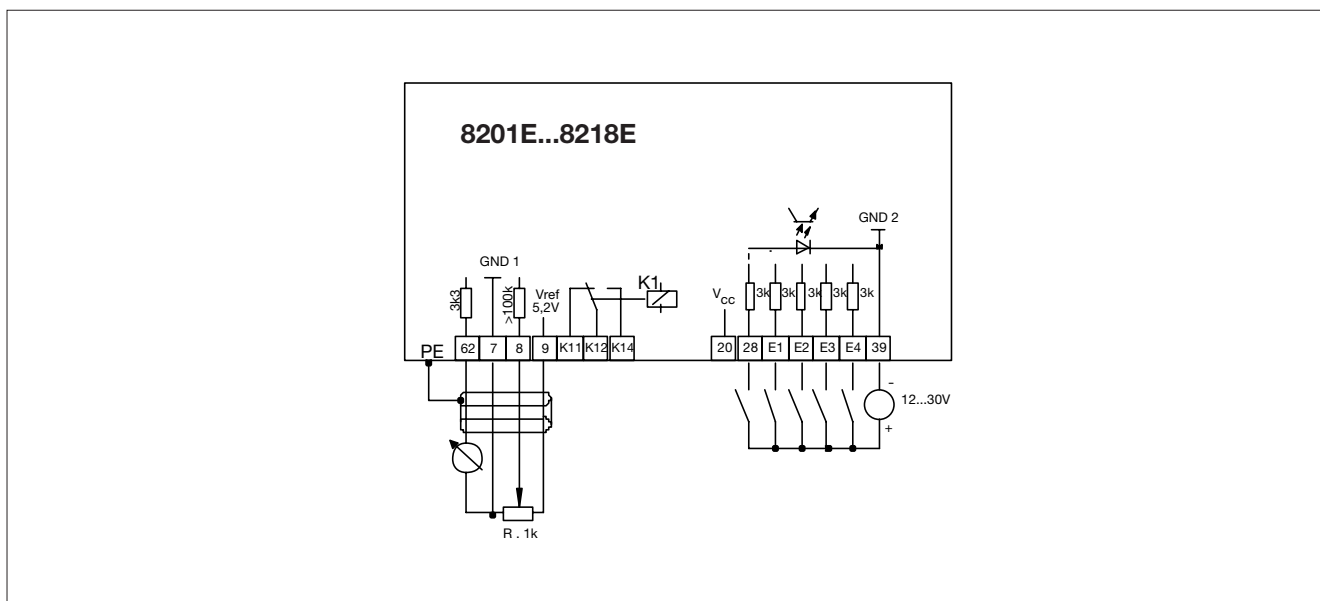

GND 1: Reference point for internal voltages

GND 2: Reference point for external voltages

GND 1 and GND 2 are electrically isolated inside the device

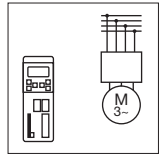

Control terminal connections – 824X and 822X frequency inverters

For power supply with internal control voltage

The control current terminals have dual basic insulation.

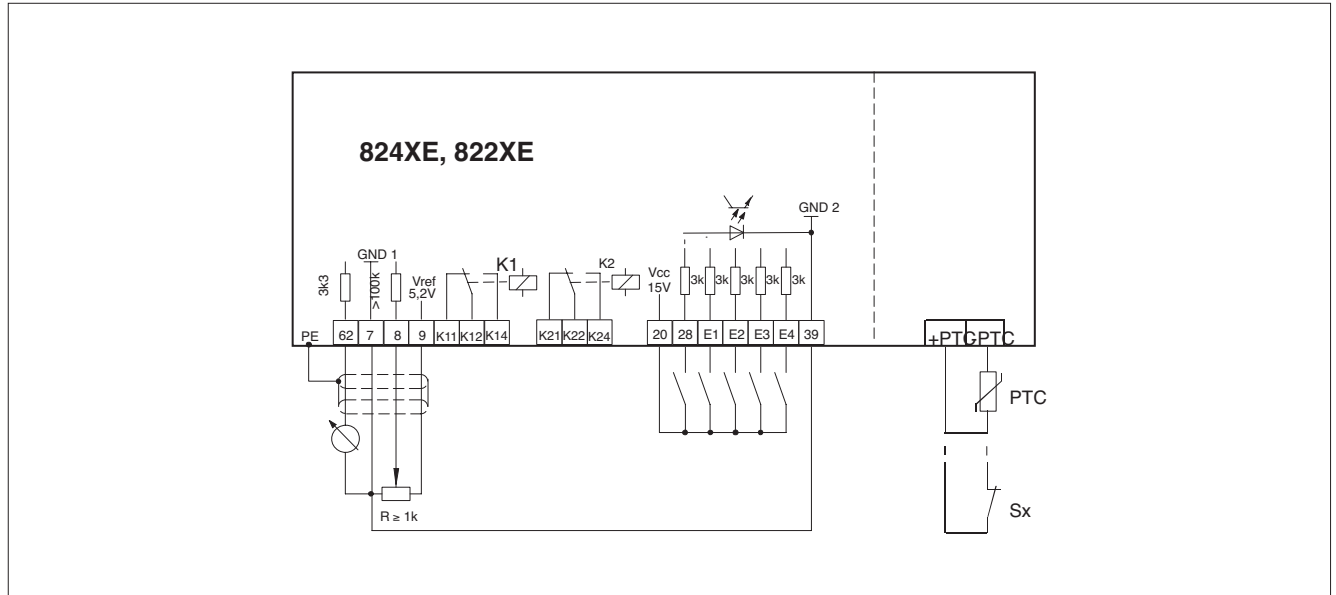

If the power is being supplied by an external control voltage (+12 ... +30 V)

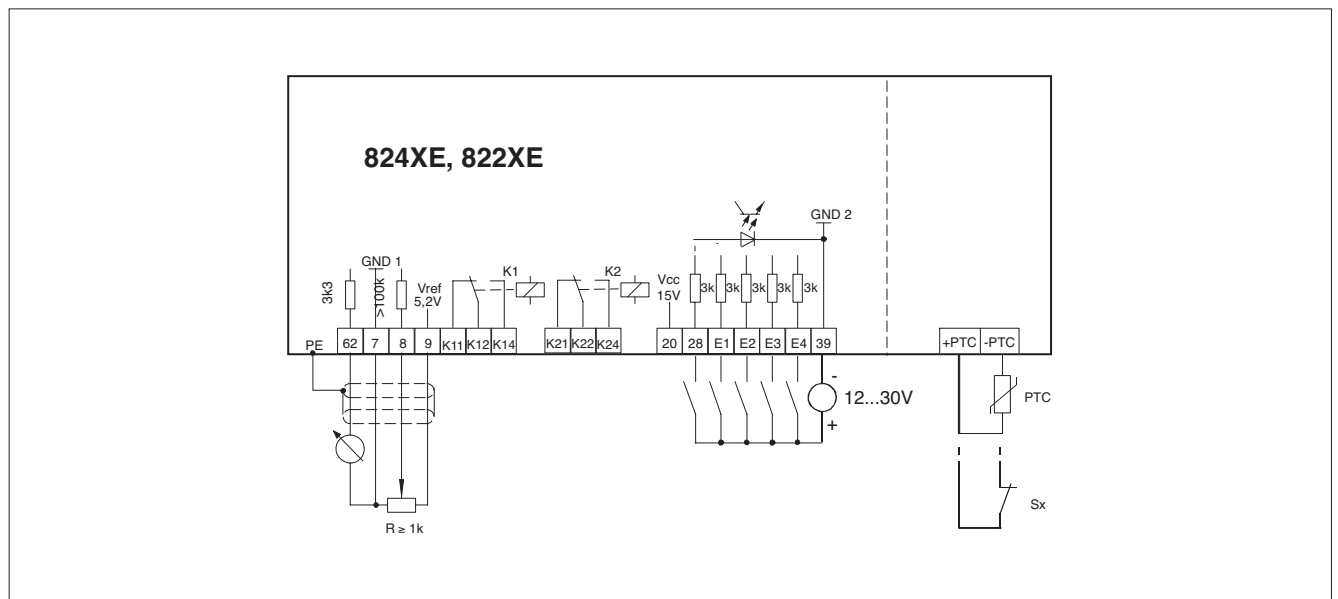

- GND 1: Reference point for internal voltages
- GND 2: Reference point for external voltages
- GND 1 and GND 2 are electrically isolated inside the device

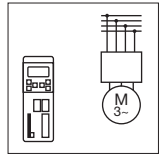

Power connection - 9300 vector frequency inverters

Connection to three-phase mains 3 x 400 ... 460 V/480 V

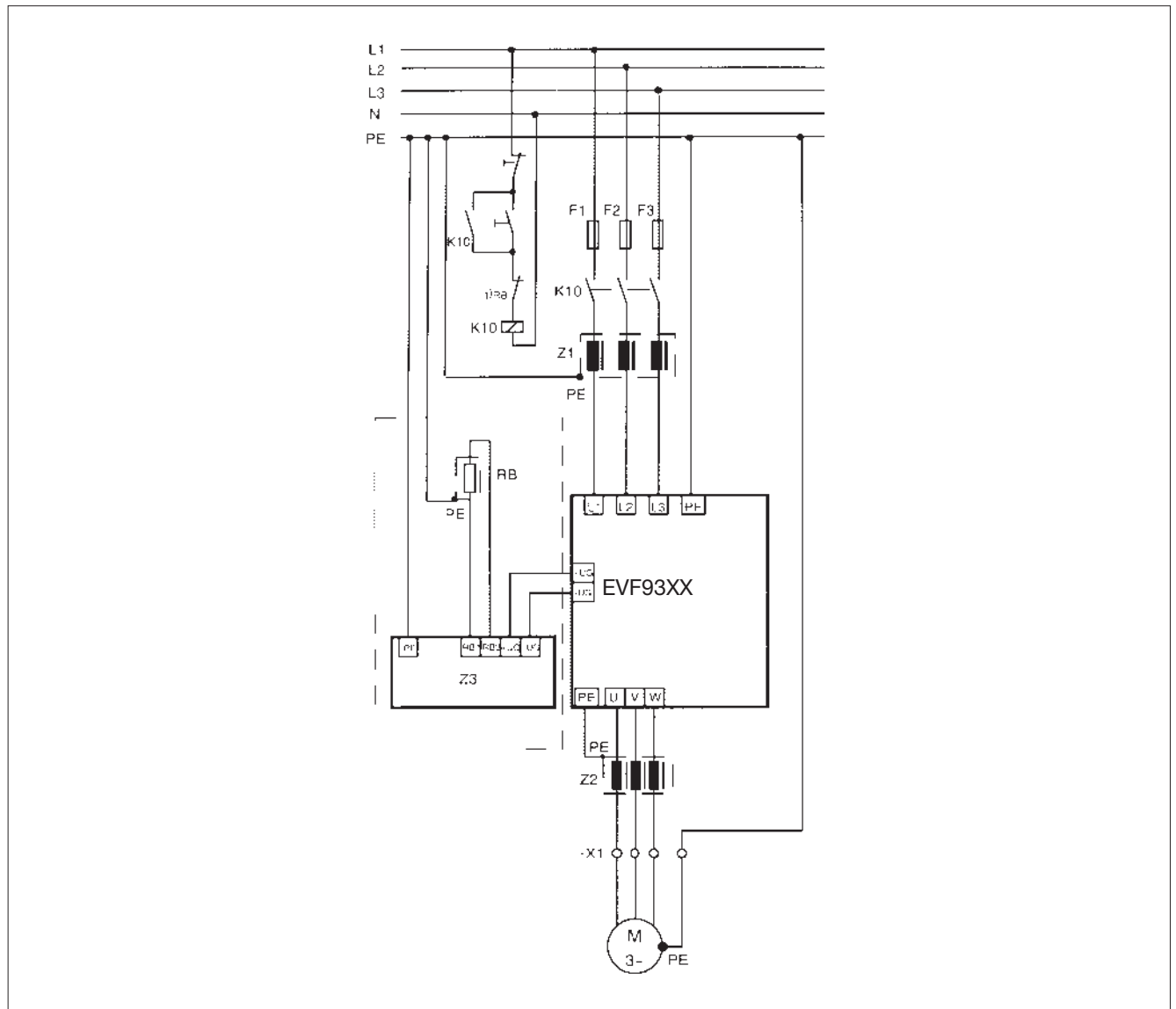

F1, F2, F3 Line protection

K10 Mains contactor

Z1 Mains choke/mains filter, see Accessories

Only operate 9327-9333 inverters with an assigned mains choke/mains filter

Z2 Motor filter/sinusoidal filter, see Accessories

Z3 Brake chopper/brake module, see Accessories

RB Brake resistor, see Accessories

ϑ_{RB} Temperature monitoring for brake resistor

-X1 Terminal strip in control cabinet

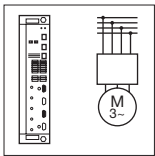

Application examples

Connecting diagrams

Connecting diagrams for 9300 vector frequency inverters

Notes about control cables

The frequency inverters have a number of digital and analog inputs and outputs. An internal or external control voltage can be used to supply them with power.

The control current terminals have basic insulation.

If protection against electrical contact is required,

- Double insulation must be implemented
- The components to be connected must be provided with the second isolating distance

The following connecting diagrams should be used for the purposes of wiring:

With internal control voltage	With external control voltage
Digital inputs and outputs	Digital inputs and outputs
Analog inputs and outputs	Analog inputs and outputs

Notes about wiring

Connect the control cables to screw terminals X5 and X6 on the front of the drive controller. Torque: 0.5 -0.6 Nm

Shielding the control cables:

- The PE connection is made via the shield sheet shown (included in the assembly kit).
Do not use it for the purposes of strain relief!
- Using a screw, connect the shield sheet on the drive controller with PE.

External control voltage

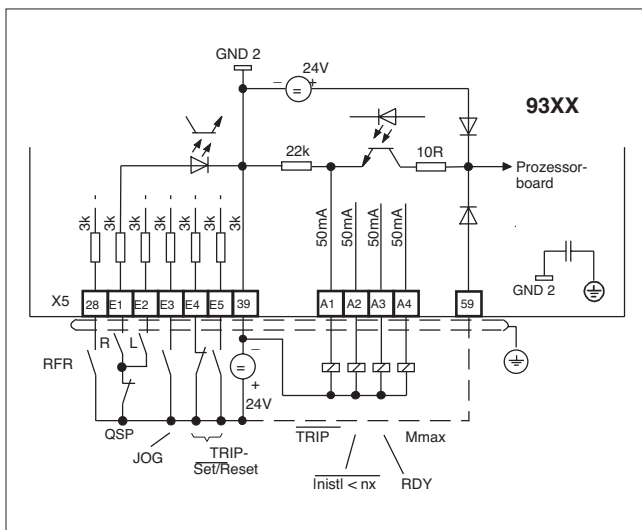

Internal control voltage

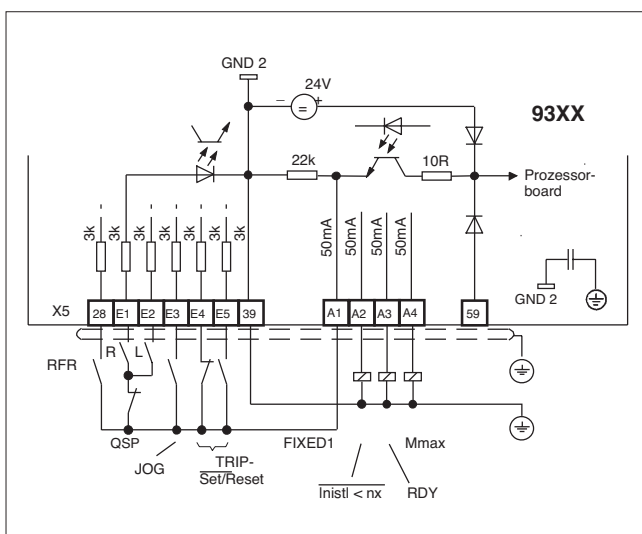

Example: Assignment of input and output terminals

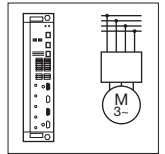

DC-bus operation with 9340 supply and regenerative feedback modules

We recommend the use of a supply and regenerative feedback module if you are using the frequency inverters in multi-axis applications. The wiring diagram below illustrates a possible circuit for DC-bus operation.

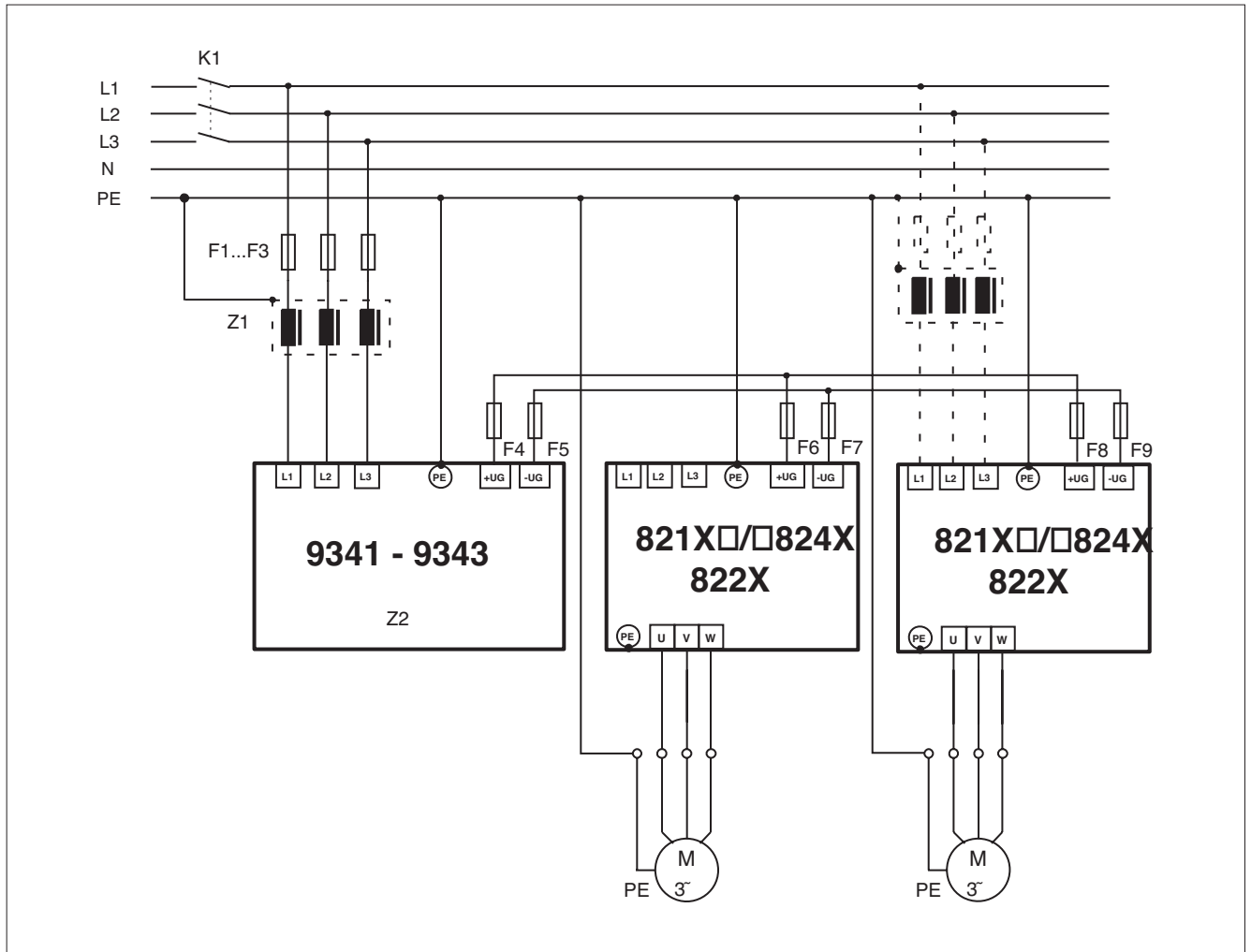

- Z1: Mains filter
- Z2: Supply and regenerative feedback module
- F1...F3: Mains fuses
- F4...F9: DC fuses
- K1: Mains contactor

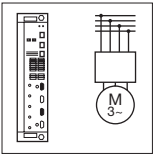

Application examples

Applications

DC-bus operation with 9340 supply and regenerative feedback modules

We recommend the use of a supply and regenerative feedback module if you are using the frequency inverters in multi-axis applications. The wiring diagram below illustrates a possible circuit for DC-bus operation.

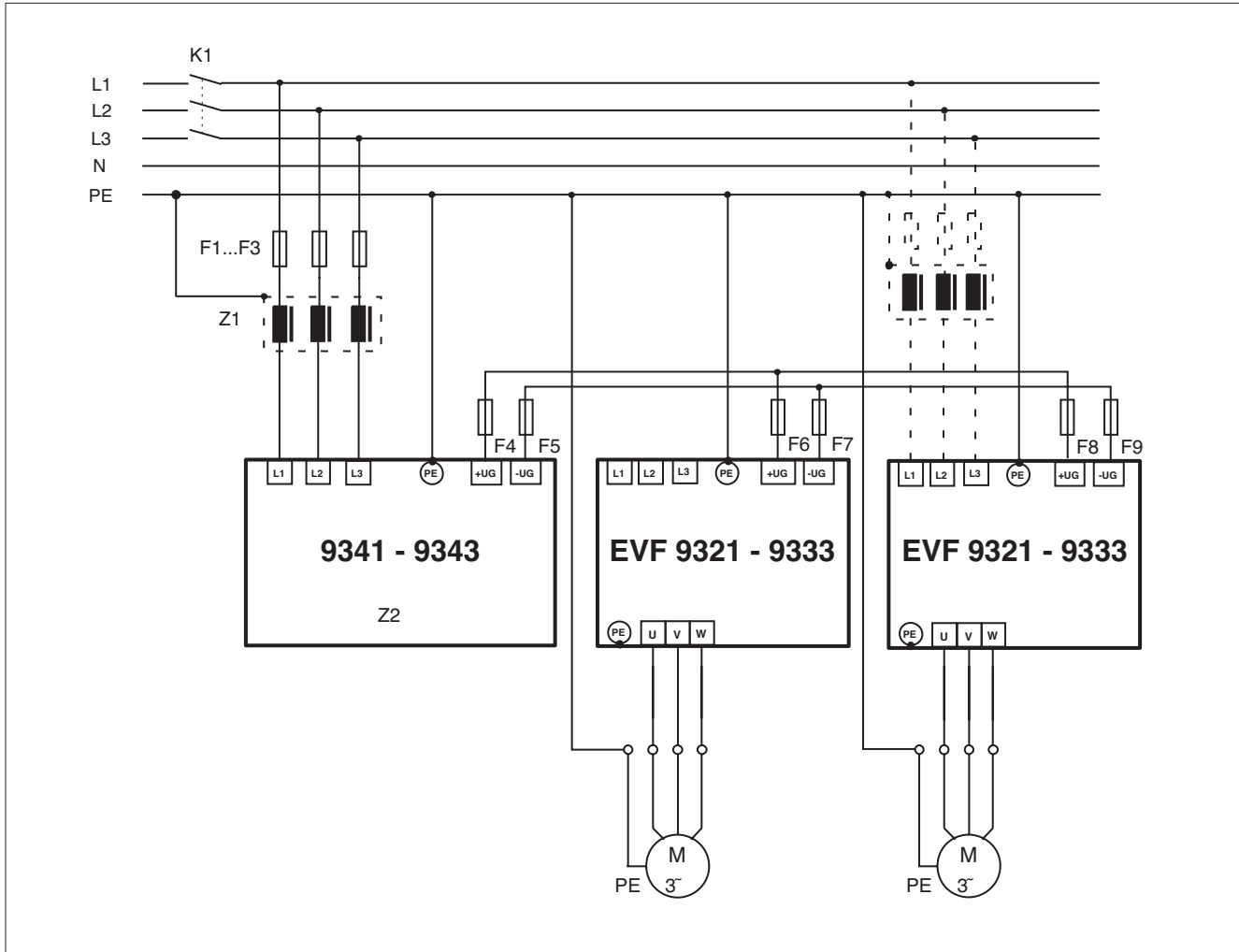

- Z1 Mains filter
- Z2 Supply and regenerative feedback module
- F1...F3: Mains fuses
- F4...F9: DC fuses
- K1: Mains contactor

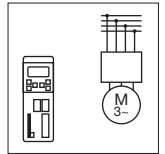

Pump application with pressure control

A centrifugal pump is to maintain constant pressure in a pipe system (e.g. water supply for private households or industrial plants). In addition to a network connection to the control room, on-site set-up should also be possible. The pressure should drop to a fixed value for a specific period of time during which demand is reduced. This provides an indirect means of detecting possible breaks in the pipe by monitoring actual pressure values.

Functions used:

- Internal PID controller for humidity control
 - Normal control, setpoint selection via fieldbus with feedback via analog channel terminal 8
- Networking via fieldbus (e.g. via 2102)
- Manual/remote changeover (M/Re.)
 - Switch between setpoint selection via fieldbus and manual switch (terminal E1 = Down, terminal E2 = Up)
- Process setpoint selection via inverter JOG values
- Electronic device lock (RFR)

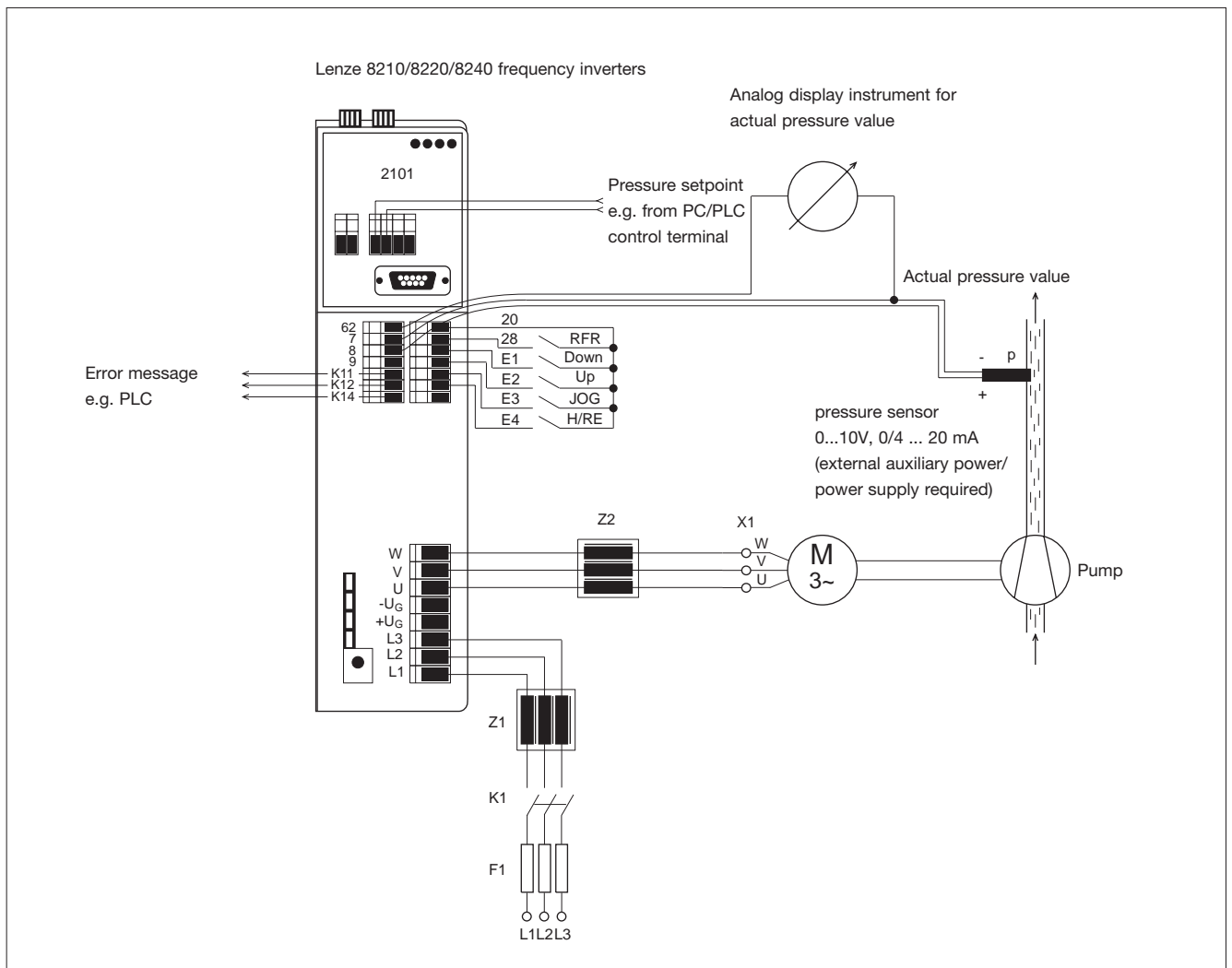

Using a pump with pressure control

*Z₁: Mains filter required for radio interference level A or B

*Z₂: Motor filter required for motor cables 50 m and longer (shielded), 100 m and longer (unshielded)

Sinusoidal filter required for motor cables 100 and longer (shielded), 200 m and longer (unshielded)

All signal cables and motor cables must be shielded

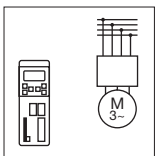

Application examples

Applications

Air conditioning system

An air conditioning system is for example to operate in a department store based on the number of people present in the building. The fans must increase or decrease the air circulation depending on the number of people present (preset e.g. based on a counter).

Functions used:

- V-belt monitoring
- Mains failure detection
 - Controlled shutdown of drive in the event of a mains failure
- Flying restart with coasting motor
- Elimination of mechanical resonances
- Smooth start/stop along S ramps

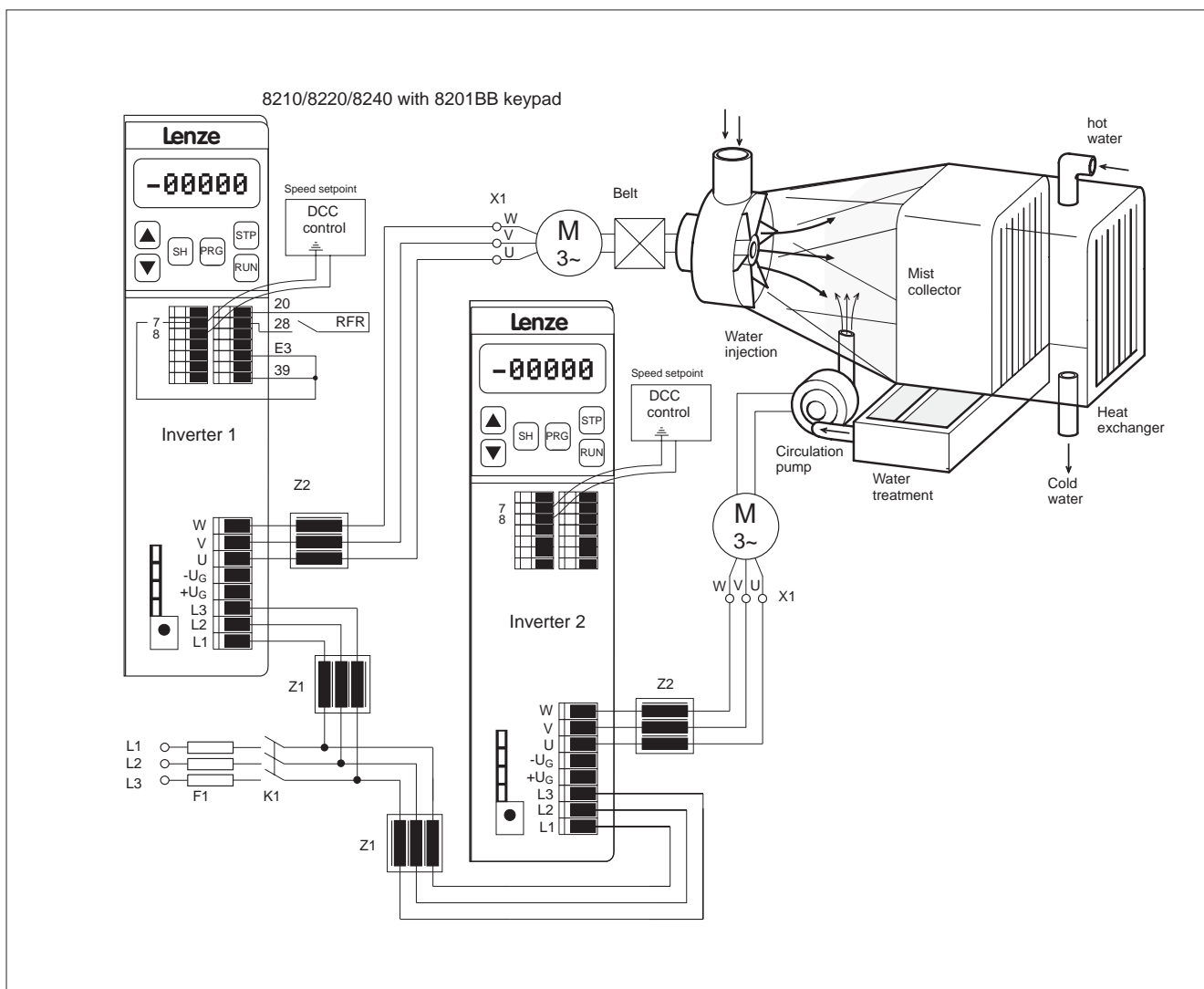

Application example for an air conditioning system

*Z₁: Mains filter required for radio interference level A or B

*Z₂: Motor filter required for motor cables 50 m and longer (shielded), 100 m and longer (unshielded)

Sinusoidal filter required for motor cables 100 and longer (shielded), 200 m and longer (unshielded)

All signal cables and motor cables must be shielded

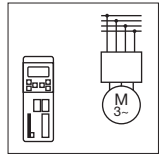

Pump application with level control

The water level in a water tank must remain constant. Depending on the amount of water drained, the feed pumps must adjust the speed and refill the tank with water.

Functions used:

- Internal PID controller for level control
 - Normal control, analog setpoint selection via terminal 8 with feedback via analog channel E1 with plug-in module 8279

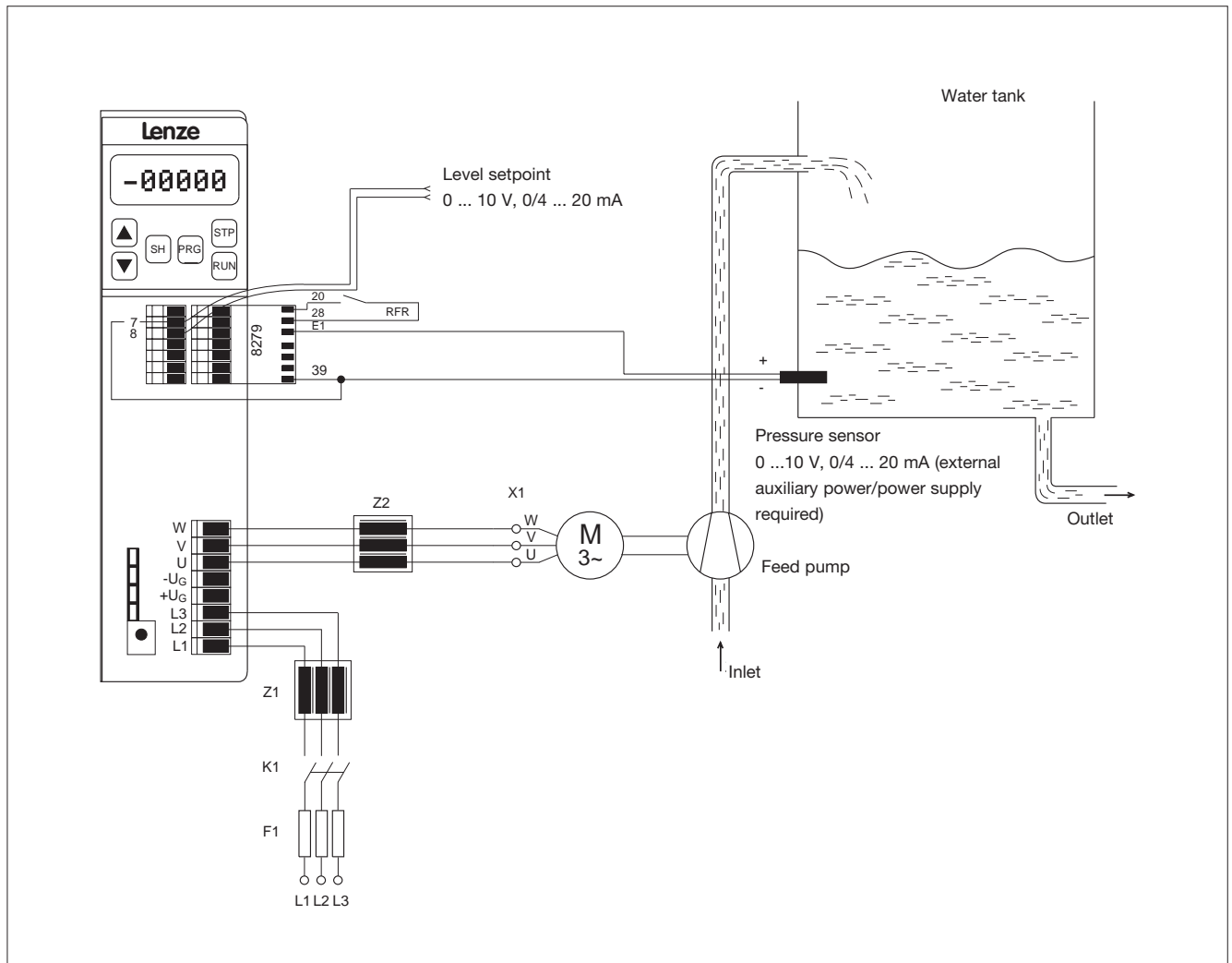

Using a pump with level control

*Z₁: Mains filter required for radio interference level A or B

*Z₂: Motor filter required for motor cables 50 m and longer (shielded), 100 m and longer (unshielded)

Sinusoidal filter required for motor cables 100 and longer (shielded), 200 m and longer (unshielded)

All signal cables and motor cables must be shielded

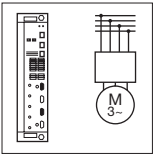

Application examples

Applications

Step control

Applications in which the drive should repeatedly turn a specific number of revolutions. This type of application is used for example to move unit loads on a conveyor belt sequentially or for dosing specific amounts repeatedly on worm conveyors.

The conveyor speed and path or dosing speed and amount are controlled independently of one another via the two analog inputs.

The execution of a step is started via a digital input.

Functions used:

- Optimum acceleration ramp generation
- Speed measurement
- Brake control

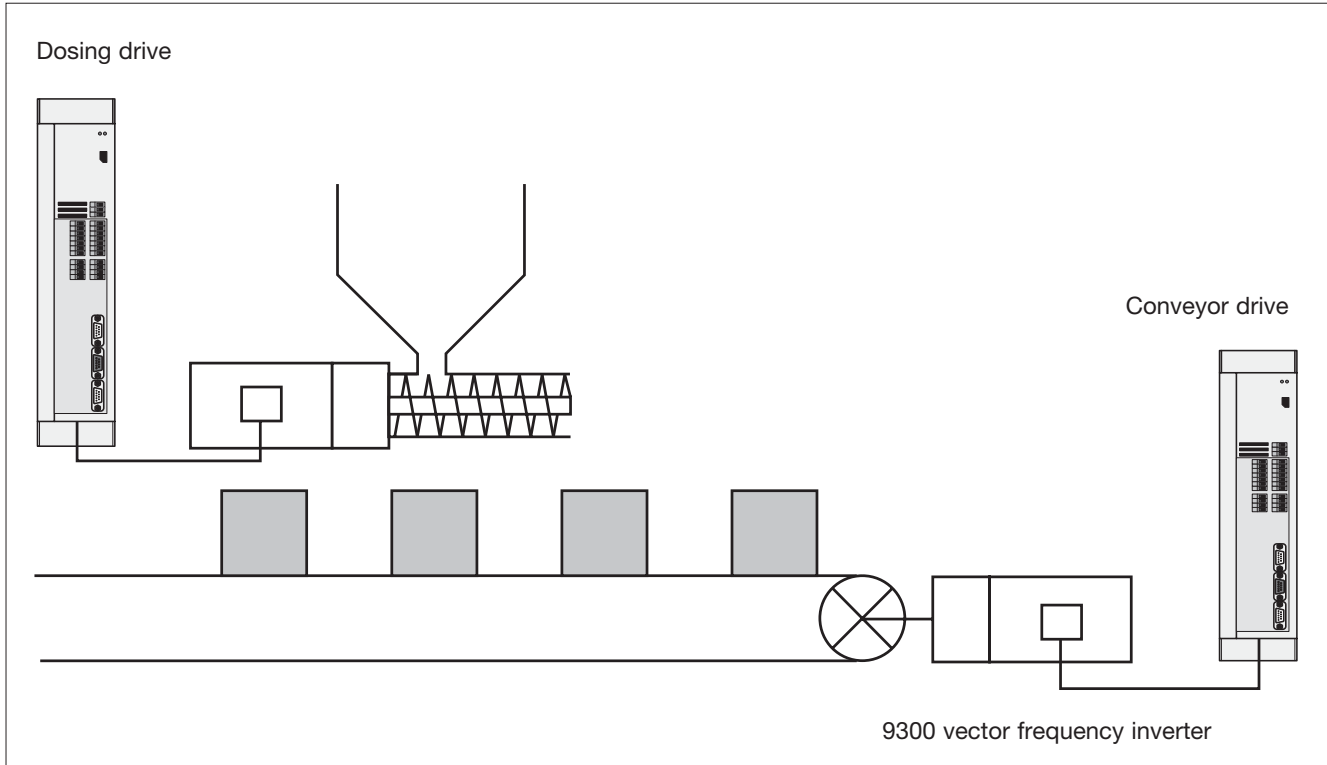

Basic structure of a step controller for a bulk material filling station

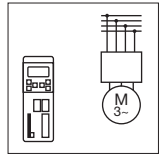

Traversing control

Spindle drives for moving material by means of winding. The speed of the winding drive is transferred in an analog input which is used to control the speed of the winder. The reversing of the direction of rotation is controlled via digital inputs. Limit switches operating as normally closed switch/break contacts which disable the active direction of rotation can for example be used for this purpose.

Functions used:

- Constant path ramp generation
- Speed measurement
- Pilot frequency input

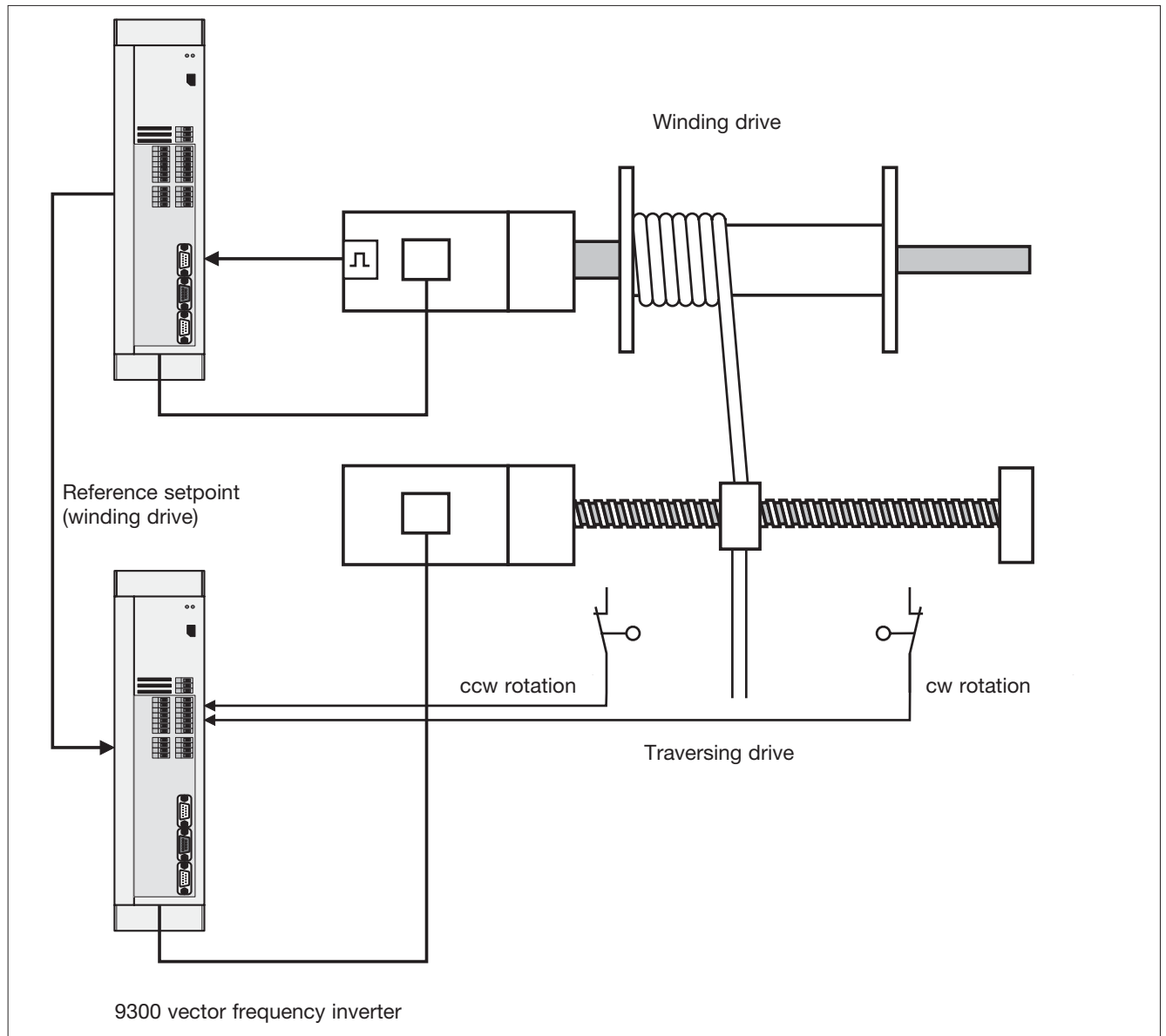

Basic structure of a traversing controller for a spindle drive on rewinders

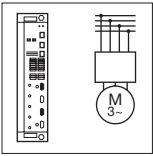

Application examples

Applications

Pilot frequency - Slave (cascade)

Integrating the drive controller into a drive system. The drive is controlled by reading in the pilot frequency setpoint via input X9. This value is then evaluated and the speed of the drive is adapted to the process based on the result of the evaluation.

An internal additional setpoint can also be activated via digital input E3.

Unlike in the pilot frequency slave configuration (bus), the evaluated control setpoint is forwarded via pilot frequency

output X10. This means that changes in the evaluation also affect subsequent drives.

Functions used:

- Pilot frequency input
- Analysis of gearbox ratio
- Analog/digital gearbox ratio trimming
- Pilot frequency ramp function generator

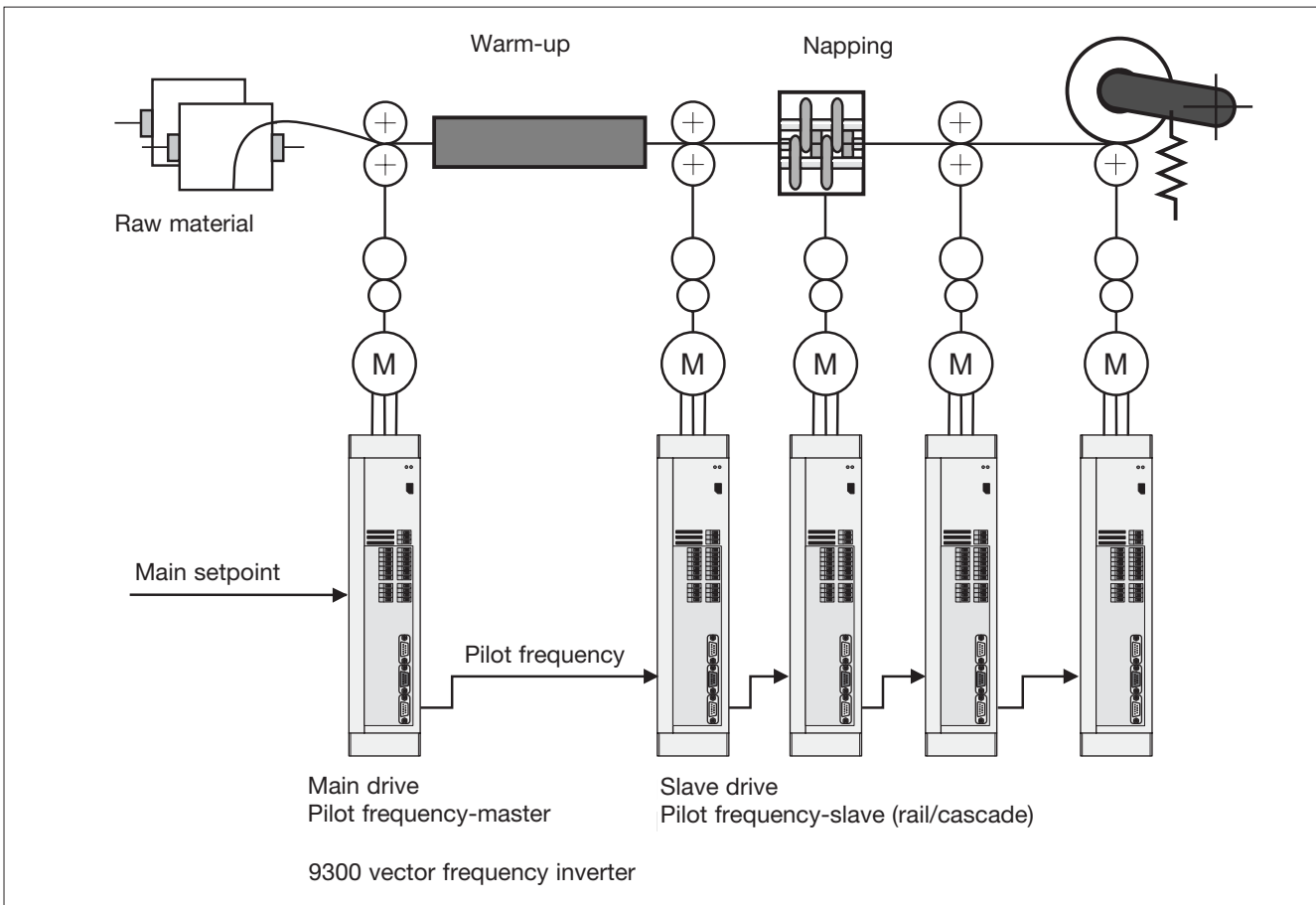

Basic structure of a pilot frequency network for textile machinery

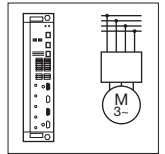

Dancer position control (internal diameter calculator)

Winding drives with dancer position control. Unlike the dancer position control configuration with external diameter detection, in this type of application, the diameter is calculated internally.

A pilot frequency signal is sent for pilot control of the drive with the system/material speed. On the basis of the actual position of the dancing roller, the dancer position controller generates a correction signal which is added to the pilot control signal. This results in a circumferential speed setpoint which, when multiplied by $1/D$, provides the speed setpoint.

The reel diameter is calculated using the signals for the line speed and the winding speed. Each time the reel changes, the new initial diameter can be loaded.

Functions used:

- Pilot frequency input
- Dancer position control
- Diameter calculation

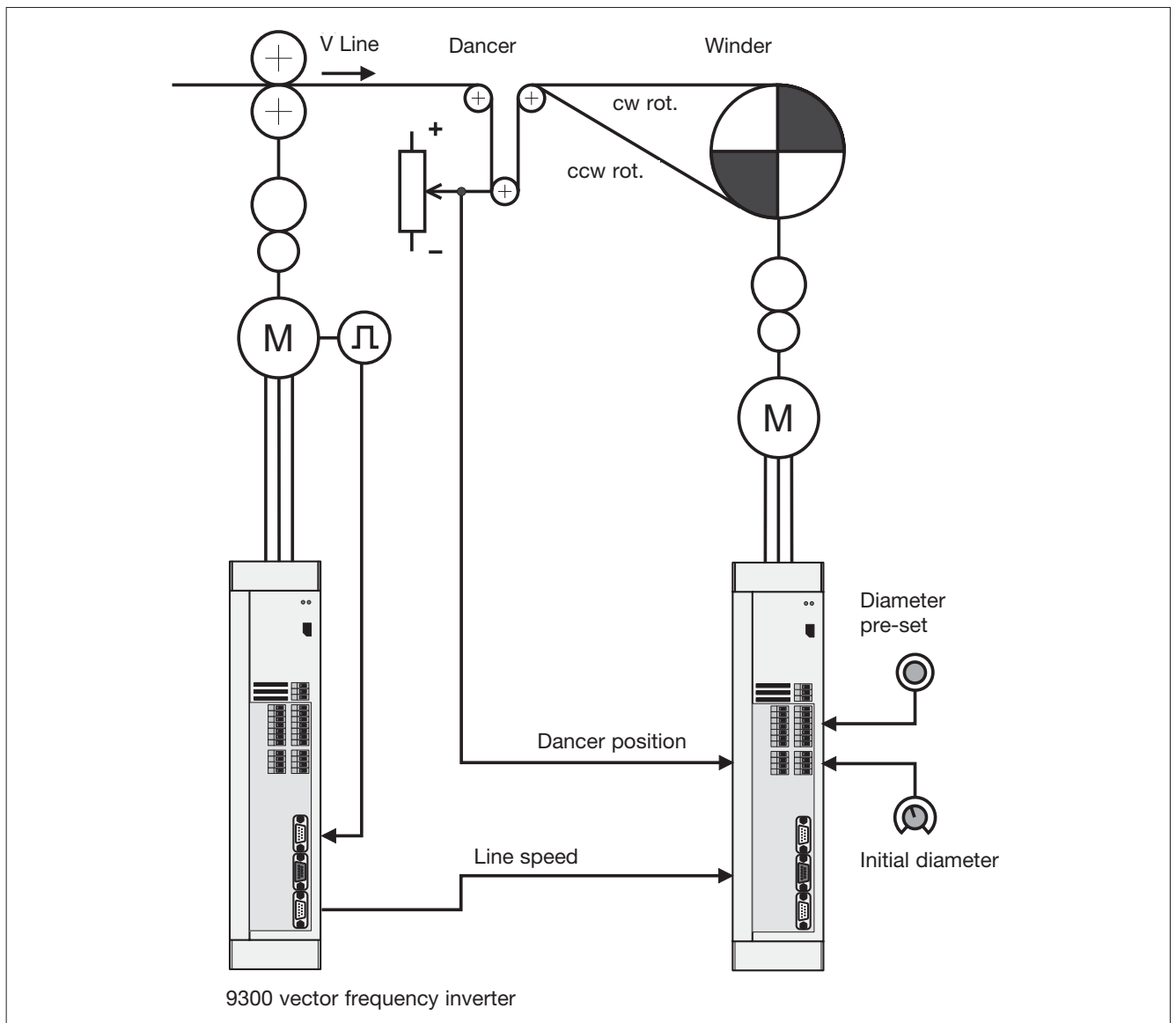

Basic structure of a dancer position controller with calculation of diameter via the internal diameter calculator

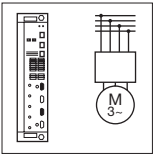

Application examples

Applications

Dancer position control (external diameter detection)

Winding drives with dancer position control and external diameter detection.

A pilot frequency signal is sent for pilot control of the drive with the system/material speed. On the basis of the actual position of the dancing roller, the dancer position controller generates a correction signal which is added to the pilot control signal. This results in a circumferential speed setpoint which, in the case of a surface winder, can be applied directly as the speed setpoint.

On a centre winding machine, the speed setpoint is obtained by evaluating the reel diameter. The analog signal generated by the diametrical sensor is preprocessed accordingly inside the controller.

Functions used:

- Pilot frequency input
- Dancer position control
- Diameter evaluation

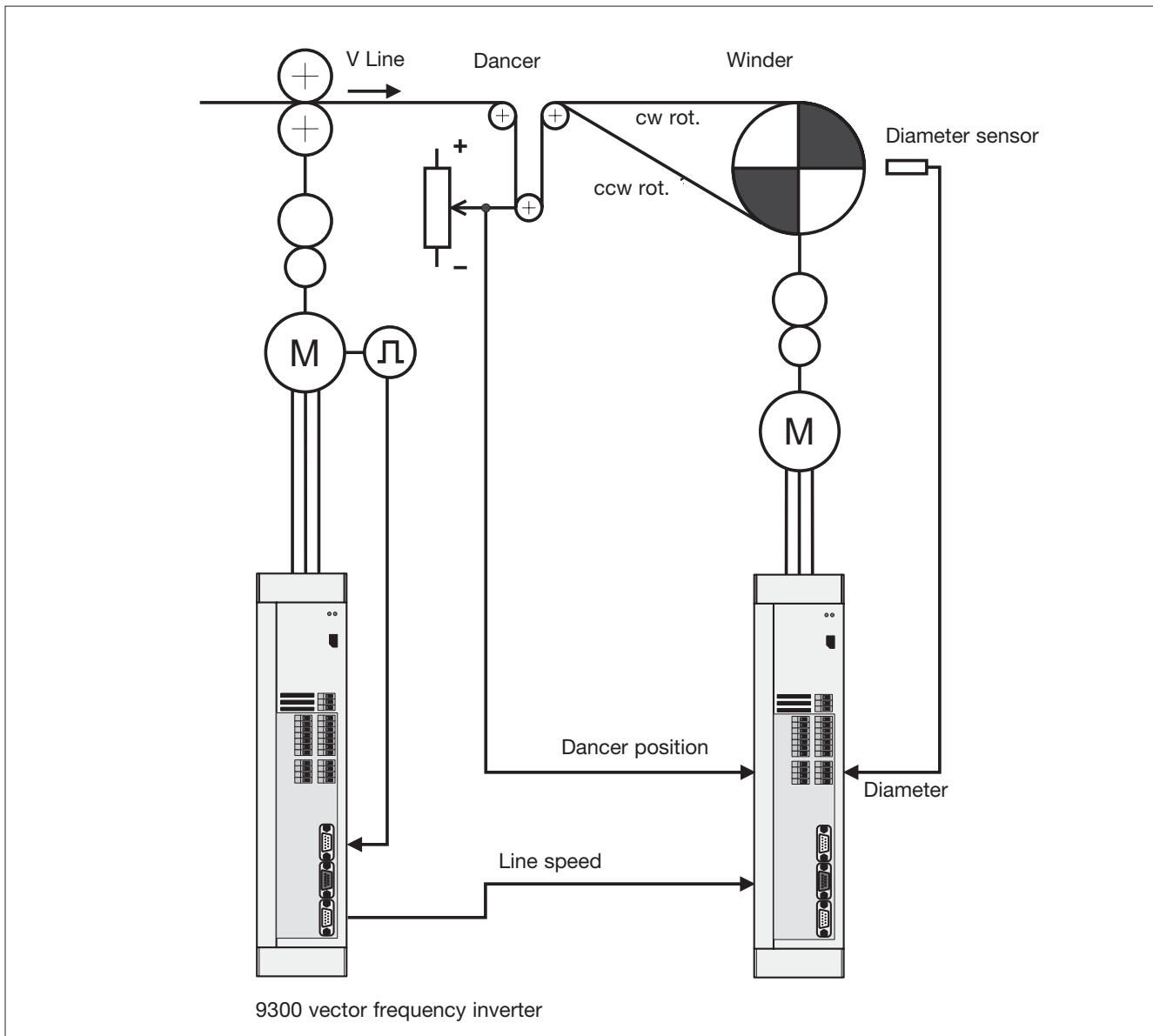

Basic structure of a dancer position controller with external diameter detection via a diametrical sensor