

Multilayer Varistor for ESD pulse [DC voltage lines/High speed signal lines]

Series : **EZJZ**



■ Features

- Excellent ESD suppression due to advanced material technology
- Meets IEC61000-4-2, Level 4 standard
- Can replace 2 Zener Diodes and 1 Capacitor
- Low capacitance versions for DC voltage lines of high speed busses
- Ultra low capacitance for signal lines of high speed busses
- Ideal usage for USB 2.0, IEEE1394, and HDMI high speed data busses
- RoHS compliant

■ Handling Precautions

see pages 75 to 80

■ Packaging Specifications

see pages 74, 144

■ Explanation of Part Numbers

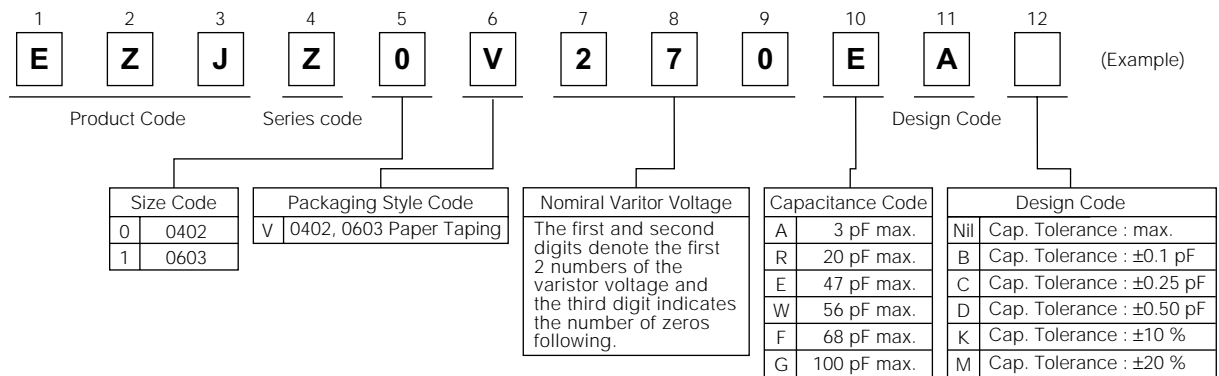

Under 3pF, the 10 or 11th position of the P/N indicates the capacitance value as follows :
2.0 pF.....20, 1.5 pF.....F15

■ Construction

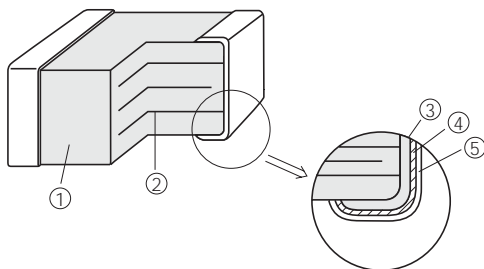

No.	Name	
①	Semiconductive Ceramics	
②	Internal electrode	
③	Terminal electrode	Substrate electrode
④		Intermediate electrode
⑤		External electrode

■ Dimensions in mm (not to scale)

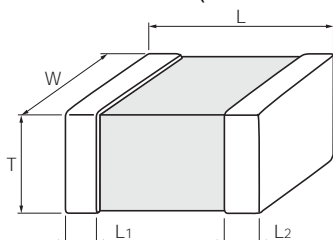

Size Code	Size	L	W	T	L ₁ , L ₂
0	0402	1.00±0.05	0.50±0.05	0.50±0.05	0.2±0.1
1	0603	1.6±0.1	0.8±0.1	0.8±0.1	0.3±0.2

Multilayer Varistor, Ultra Low Capacitance Type [High speed signal lines]

■ Features

- Multilayer monolithic ceramic construction for high speed signal lines
- Ideal usage for USB 2.0, IEEE1394, and HDMI high speed data busses
- Capacitance : 0.8 to 2.1 pF typ.

■ Recommended Applications

Mobile phone	Antenna circuit, External IF
DSC, DVC	USB2.0, IEEE1394
PC, PDA	USB2.0, IEEE1394, LAN1000BASE
TV, DVD	USB2.0, IEEE1394, HDMI
Game console	Controller, External IF

■ Ratings and Characteristics

Size	Part No.	Maximum allowable voltage DC (V)	Nominal varistor voltage at 1mA (V)	Capacitance (pF)	Maximum ESD IEC61000-4-2
				at 1MHz	
0402	EZJZ0V80010	10	80	1 max. [0.8 typ.]	Contact discharge : 8kV
	EZJZ0V80015D	5	80	1.5±0.5	
	EZJZ0V500AA	5	50	3 max. [2.1 typ.]	
	EZJZ0V800AA	18	80	3 max. [2.1 typ.]	
	EZJZ0V171AA	18	170	3 max. [2.1 typ.]	
0603	EZJZ1V80010	10	80	1 max. [0.8 typ.]	
	EZJZ1V500AA	5	50	3 max. [2.1 typ.]	
	EZJZ1V800AA	18	80	3 max. [2.1 typ.]	
	EZJZ1V171AA	18	170	3 max. [2.1 typ.]	

- Operating Temperature Range : -40 to 85 °C
- * Recommend soldering method : Reflow soldering

■ Voltage vs. Current

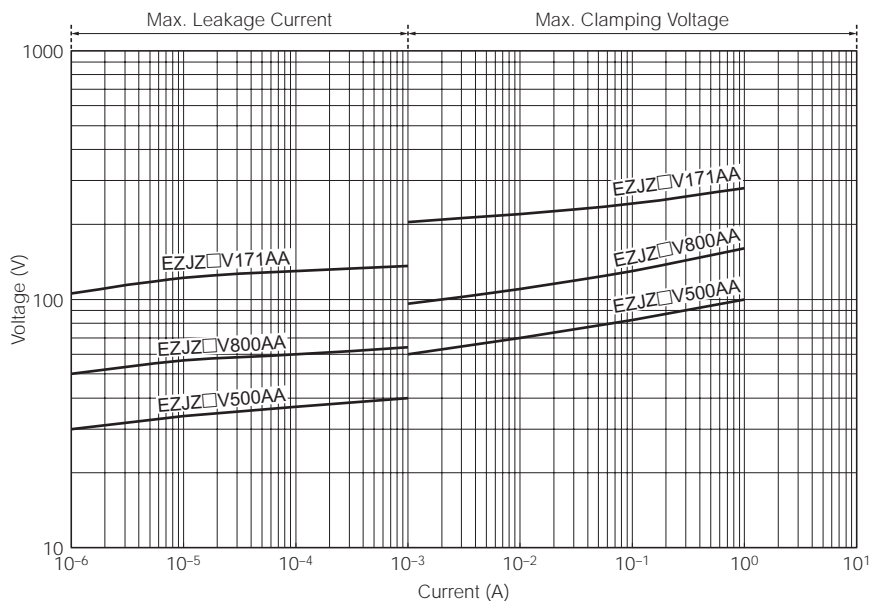

■ Frequency vs. Capacitance

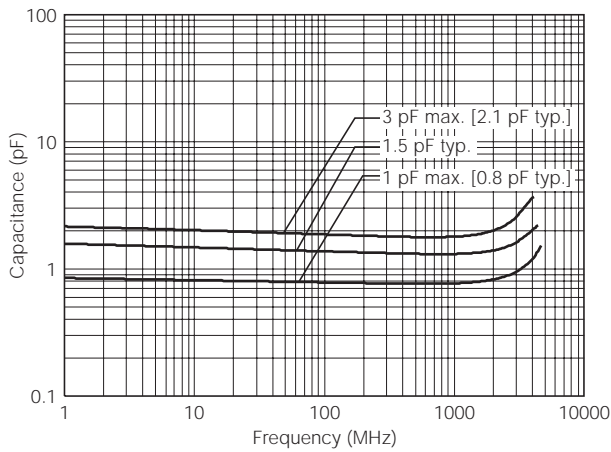

■ Frequency vs. Impedance

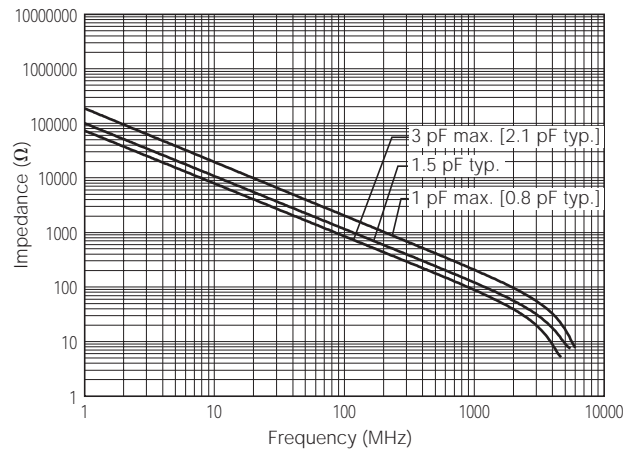

■ Frequency vs. Transmission

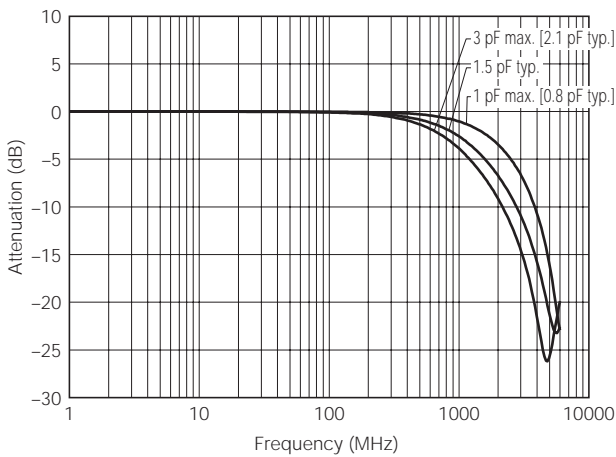

Multilayer Varistor, Low Capacitance Type (Standard Type) [DC voltage lines/Low speed signal lines]

■ Features

Multilayer monolithic ceramic construction for use protecting DC voltage lines or signal lines

● Circuit voltage

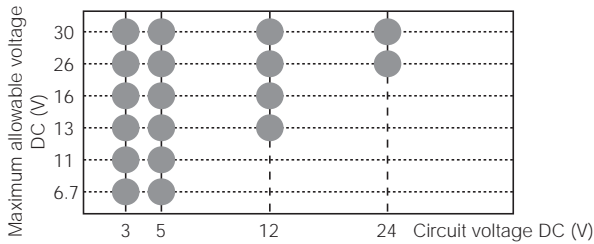

● Capacitance : 15 to 250pF typ.

■ Recommended Applications

Mobile phone	SW, LCD, LED, Audio terminal, Battery pack, Memory card, External IF
DSC, DVC	SW, LCD, LED, USB
PC, PDA	SW, LCD, LED, USB
TV, DVD	Audio, Video terminal
Audio	Audio terminal, Microphone, Receiver
Game console	Controller, External IF

■ Ratings and Characteristics

Size	Part No.	Maximum allowable voltage DC (V)	Nominal varistor voltage at 1mA (V)	Capacitance (pF)		Maximum peak current at 8/20μs, 2times (A)	Maximum ESD IEC61000-4-2
				at 1MHz	at 1kHz		
0402	EZJZ0V120JA	6.7	12	220 max. [150 typ.]	175 typ.	10	Contact discharge 8 kV
	EZJZ0V180HA	11	18	150 max. [120 typ.]	140 typ.	10	
	EZJZ0V220HA	13	22	150 max. [100 typ.]	116 typ.	10	
	EZJZ0V270EA	16	27	47 max. [33 typ.]	37 typ.	10	
	EZJZ0V270RA	16	27	20 max. [15 typ.]	16.5 typ.	3	
	EZJZ0V420WA	30	42	56 max. [40 typ.]	45 typ.	10	
0603	EZJZ1V120KA	6.7	12	330 max. [250 typ.]	290 typ.	20	
	EZJZ1V180JA	11	18	220 max. [180 typ.]	210 typ.	20	
	EZJZ1V220JA	13	22	220 max. [160 typ.]	185 typ.	20	
	EZJZ1V270GA	16	27	100 max. [85 typ.]	100 typ.	20	
	EZJZ1V270EA	16	27	47 max. [33 typ.]	37 typ.	20	
	EZJZ1V270RA	16	27	20 max. [15 typ.]	16.5 typ.	3	
	EZJZ1V330GA	26	33	100 max. [85 typ.]	100 typ.	20	
	EZJZ1V420FA	30	42	68 max. [55 typ.]	63 typ.	15	

● Operating Temperature Range : -40 to 85 °C

* Recommend soldering method : Reflow soldering

Maximum Allowable Voltage	Maximum DC Voltage that can be applied continuously within the operating temperature range
Varistor Voltage	Varistor starting voltage between terminals at DC 1 mA, also known as Breakdown voltage
Maximum Peak Current	Varistor's maximum current under the standard pulse 8/20μs, 2 times based on IEC60
Maximum ESD	Varistor's maximum voltage under ESD based on IEC61000-4-2, 10 times (5 times of each positive-negative polarity)

■ Voltage vs. Current

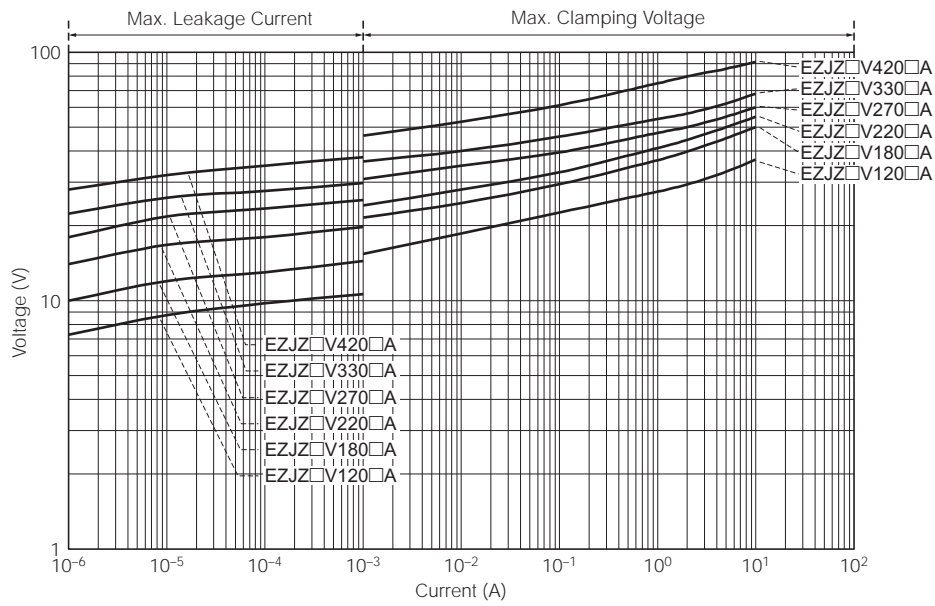

■ Frequency vs. Capacitance

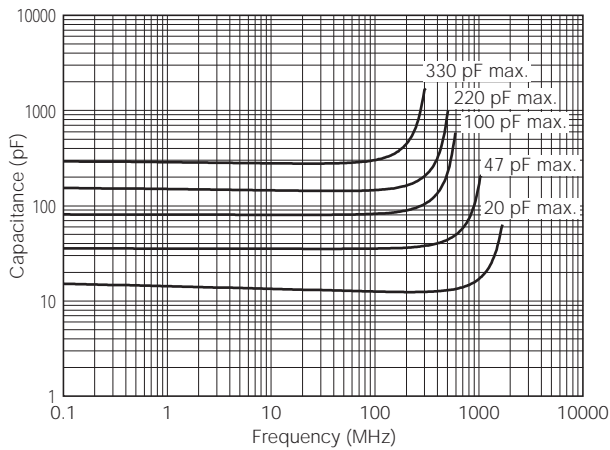

■ Frequency vs. Impedance

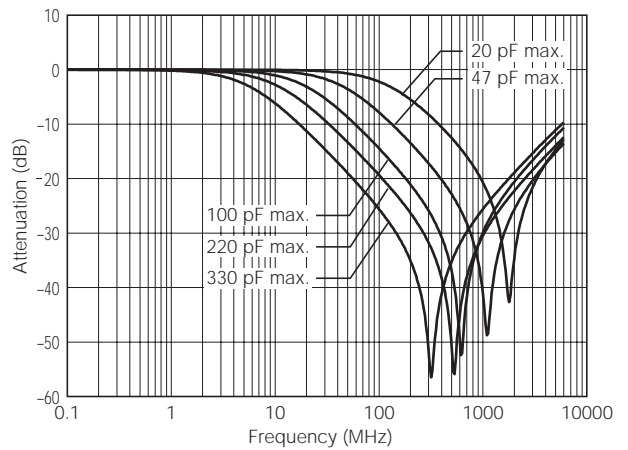

Multilayer Varistor for ESD pulse [2 Array Type for high speed signal lines]

Series : **EZJZS**

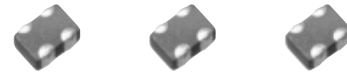

■ Features

- Excellent ESD suppression due to advanced material technology
- Meets IEC61000-4-2, Level 4 standard
- Can replace 2 Zener Diodes and 1 Capacitor
- 2 Array per package for multiple lines
- Ultra low capacitance for high speed signal lines
- Ideal usage for USB 2.0, IEEE1394, and HDMI high speed data busses
- RoHS compliant

■ Handling Precautions

see pages 75 to 80

■ Packaging Specifications

see pages 74, 144

■ Explanation of Part Numbers

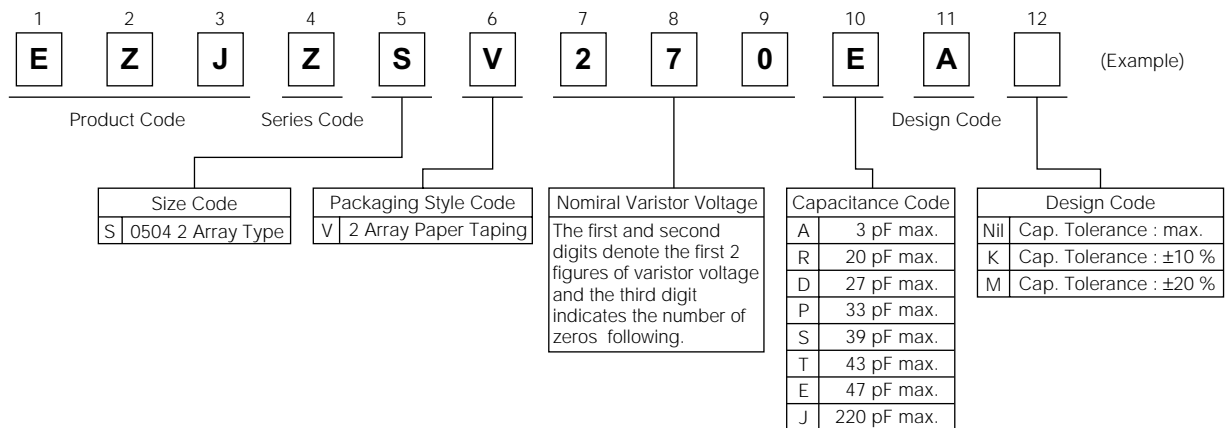

■ Construction

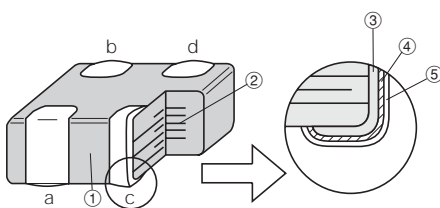

No.	Name
①	Semiconductive Ceramics
②	Internal electrode
③	Substrate electrode
④	Terminal electrode
⑤	External electrode

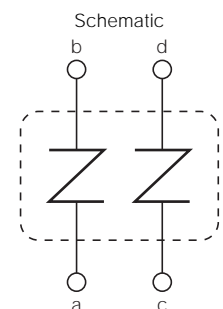

■ Dimensions in mm (not to scale)

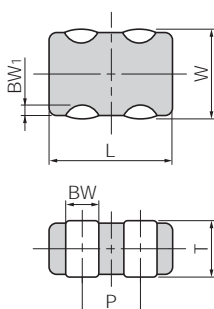

Size	L	W	T	BW	BW ₁	P
0504 (2 Array)	1.37±0.15	1.0±0.1	0.60 ^{+0.06} _{-0.10}	0.36±0.10	0.2±0.1	0.64±0.10

■ Ratings and Characteristics

Size	Part No.	Maximum allowable voltage DC (V)	Nominal varistor voltage at 1mA (V)	Capacitance (pF)		Maximum peak current at 8/20 μ s, 2times (A)	Maximum ESD IEC61000-4-2
				at 1MHz	at 1kHz		
0504 (2 Array)	EZJZSV120JA	6.7	12	220 max. [150 typ.]	175 typ.	10	Contact discharge 8 kV
	EZJZSV270EA	16	27	47 max. [33 typ.]	37 typ.	10	
	EZJZSV270RA	16	27	20 max. [15 typ.]	16.5 typ.	3	
	EZJZSV270DA□	16	27	27 \pm 10 % / \pm 20 %	30 typ.	5	
	EZJZSV270PA□	16	27	33 \pm 10 % / \pm 20 %	37 typ.	5	
	EZJZSV270SA□	16	27	39 \pm 10 % / \pm 20 %	43 typ.	5	
	EZJZSV270TA□	16	27	43 \pm 10 % / \pm 20 %	47 typ.	5	
	EZJZSV270EA□	16	27	47 \pm 10 % / \pm 20 %	52 typ.	5	
	EZJZSV500AA	5	50	3 max. [2.1 typ.]	—	—	
	EZJZSV800AA	18	80	3 max. [2.1 typ.]	—	—	
EZJZSV171AA	18	170	3 max. [2.1 typ.]	—	—		

● Operating Temperature Range: -40 to 85 °C

* □ : Capacitance Tolerance Code K: \pm 10 %, M: \pm 20 %

* Avoid flow soldering.

■ Voltage vs. Current

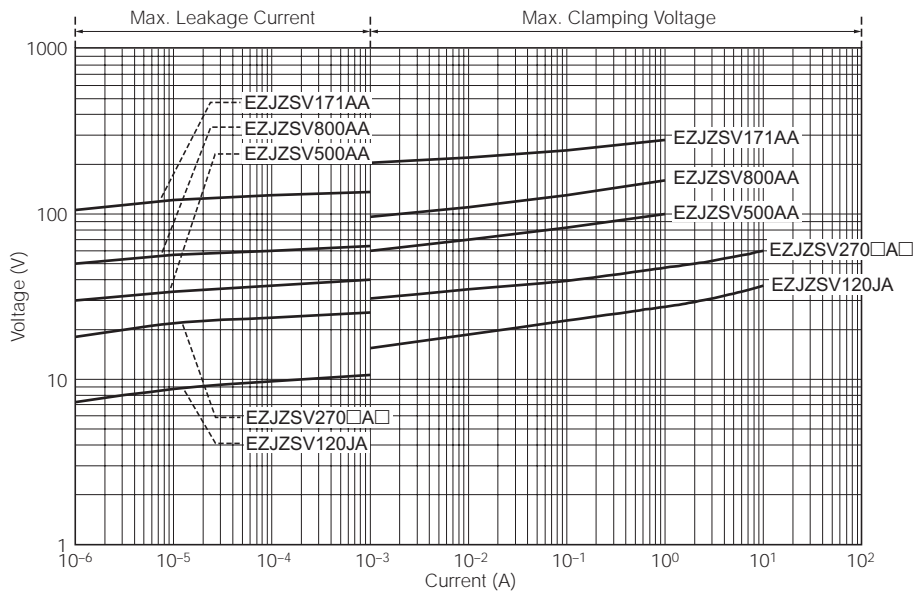

■ Frequency vs. Capacitance

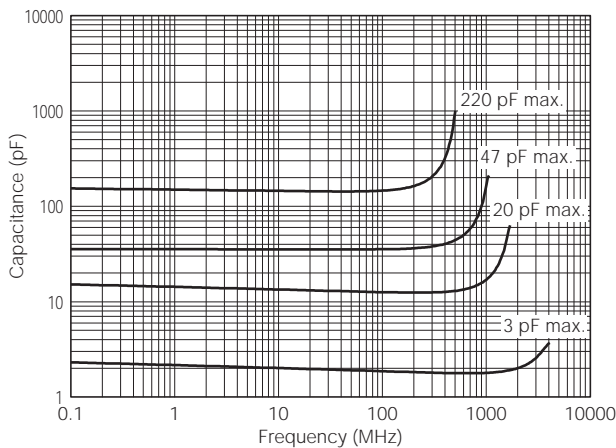

■ Frequency vs. Impedance

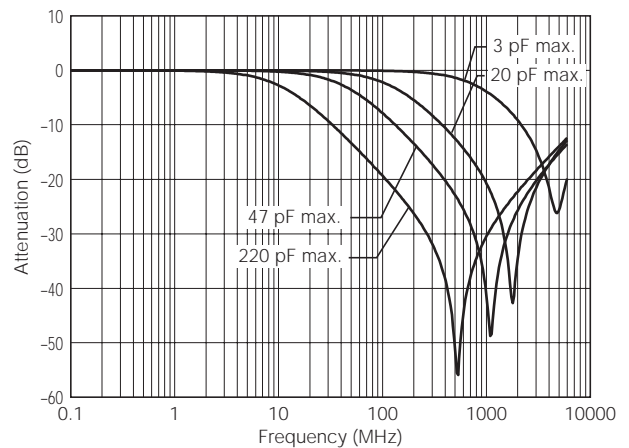

Multilayer Varistor for ESD pulse [DC voltage lines]

Series : **EZJS**



■ Features

- Excellent ESD suppression due to advanced material technology
- Meets IEC61000-4-2, Special Level 30 kV standard
- Can replace 2 Zener Diodes and 1 Capacitor
- RoHS compliant

■ Handling Precautions

see pages 75 to 80

■ Packaging Specifications

see pages 74, 144

■ Explanation of Part Numbers

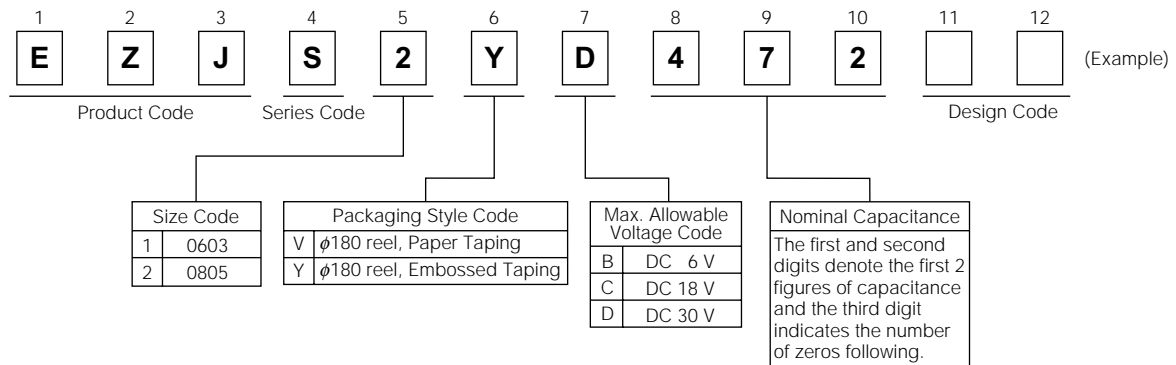

■ Construction

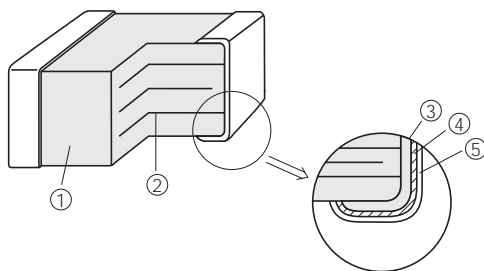

No.	Name	
①	Semiconductive Ceramics	
②	Internal electrode	
③	Terminal electrode	Substrate electrode
④		Intermediate electrode
⑤		External electrode

■ Dimensions in mm (not to scale)

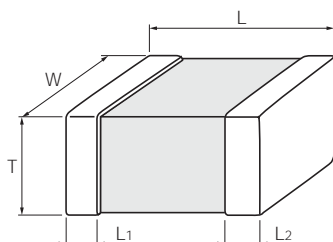

Size Code	Size	L	W	T	L ₁ , L ₂
1	0603	1.60±0.15	0.8±0.1	0.8±0.1	0.3±0.2
2	0805	2.0±0.2	1.25±0.20	0.8±0.2	0.50±0.25
				1.25±0.20	

■ Ratings and Characteristics

Size	Part No.	Maximum Allowable Voltage DC (V)	Nominal Varistor Voltage at 0.1 mA	Capacitance at 1 kHz	Maximum ESD IEC61000-4-2
0603	EZJS1VB822	6	12	8200 typ.	Contact discharge : 30 kV
	EZJS1VC392	18	30	3900 typ.	
	EZJS1VD182	30	50	1800 typ.	
0805	EZJS2VB223	6	12	22000 typ.	
	EZJS2YC822	18	30	8200 typ.	
	EZJS2YD472	30	50	4700 typ.	

- Operating Temperature Range: -40 to 85 °C
- * Recommend soldering method : Reflow soldering
- * 0805 size avoid flow soldering

■ Voltage vs. Current

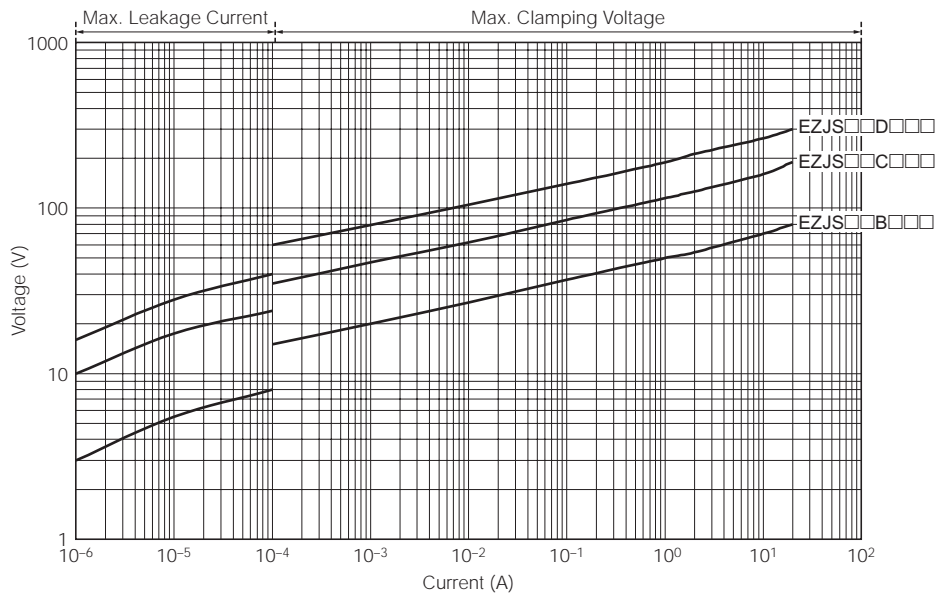

■ Frequency vs. Capacitance

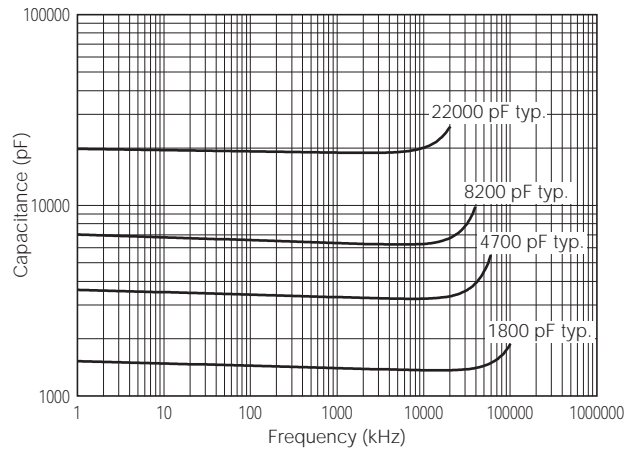

■ Frequency vs. Transmission

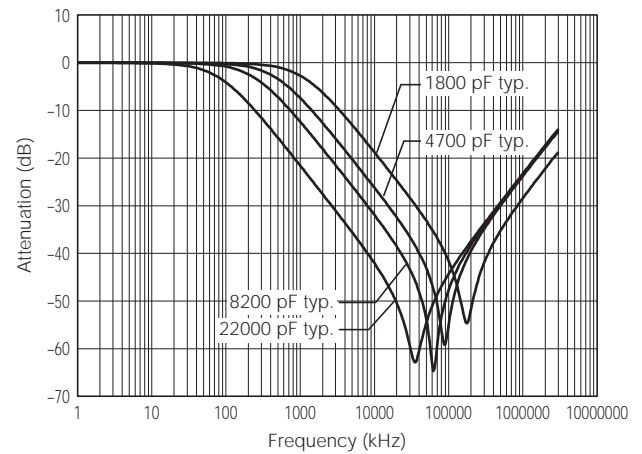

Varistor Characteristics and Equivalent Circuit

A Multilayer Varistor does not have an electrical polarity like zener diodes and is equivalent to total 3 pcs. of 2 zener diodes and 1 capacitor.

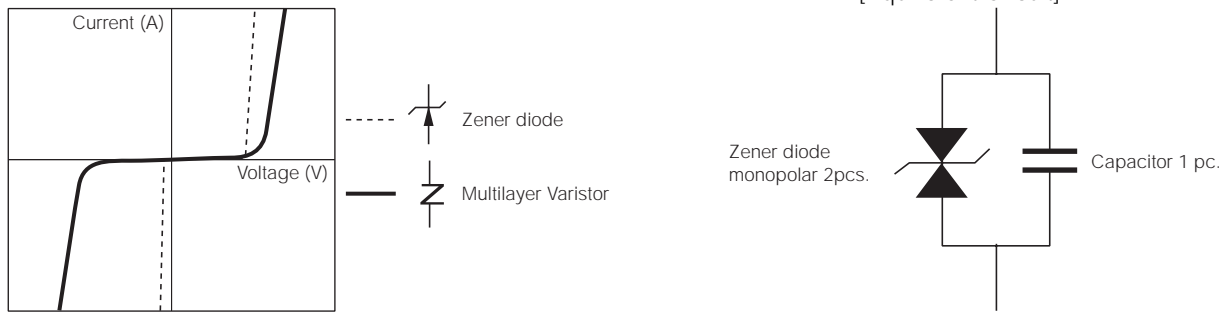

ESD Suppressive Effects

Typical effects of ESD suppression

Test conditions: IEC61000-4-2* Level 4 Contact discharge, 8 kV

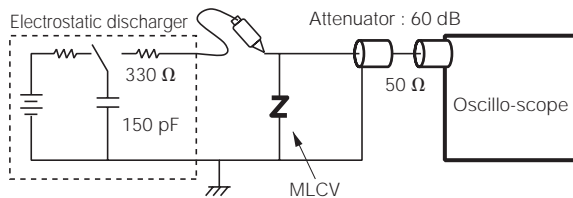

[ESD suppressed waveform]

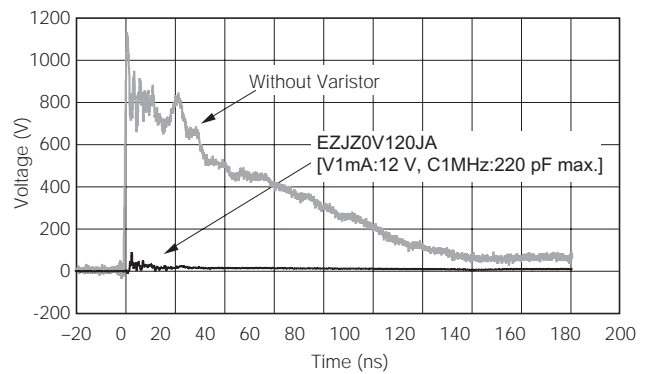

* IEC61000-4-2 ... International Standard of the ESD testing method (HBM) setting 4 levels of severity

Severity	Level 1	Level 2	Level 3	Level 4
Contact discharge	2 kV	4 kV	6 kV	8 kV
Air discharge	2 kV	4 kV	8 kV	15 kV

Replacement of Zener diode

Using a Multilayer Varistor to replace a "Zener diode & Capacitor" saves both the amount of space and number of components used

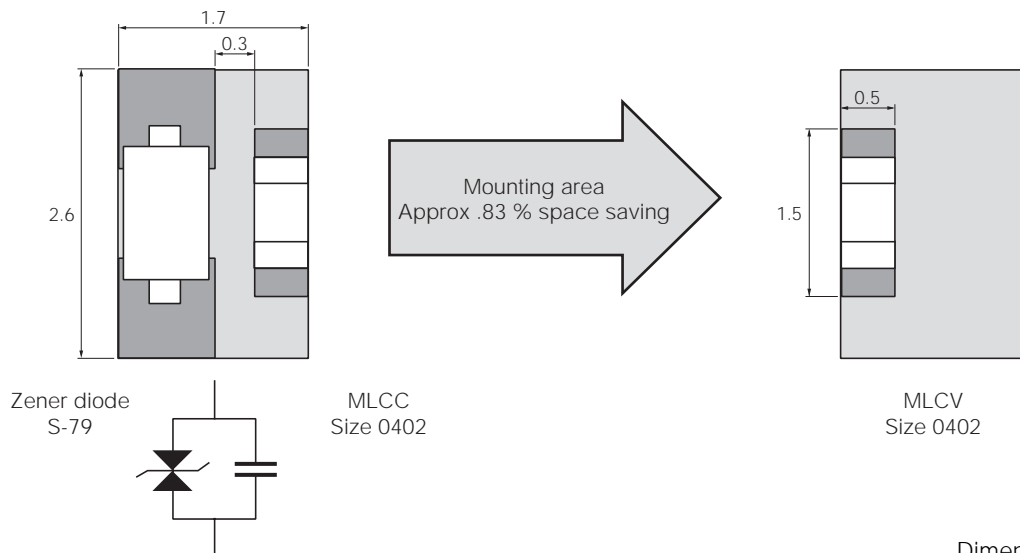

Recommended Applications

Applications	Series	Circuit				
		DC	1k	1M	1G (Hz)	
Mobile phones, DSC, PC, PDA, HDD TV (PDP, LC etc.), DVD, DVC, Game consoles, Audio equipment	Series EZJZ	Ultra low capacitance (Cap. : 3 pF or less)				DC to GHz Antenna, RF circuit, LVDS USB, IEEE1394, HDMI etc.
		Low capacitance (Cap. : 20 to 330 pF)				DC to millions of Hz PWR, SW, Audio terminals LCD, RS232C, etc.
PWR, Photoelectronic sensors, SSR, Motors, Pressure sensors, Proximity switches	Series EZJS	High capacitance (Cap. : 1800 to 22000 pF)				DC to thousands of Hz PWR, SW, Audio terminals etc.

Applications

Mobile Phone

· Audio lines

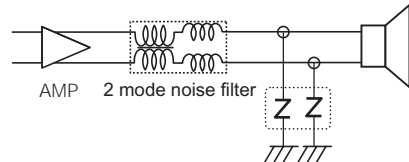

· LED

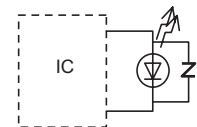

· SW/Keyboard

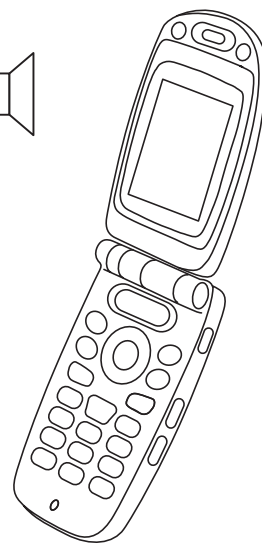
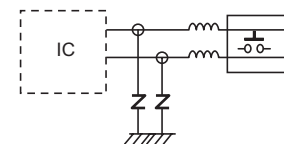

· LCD/Camera lines

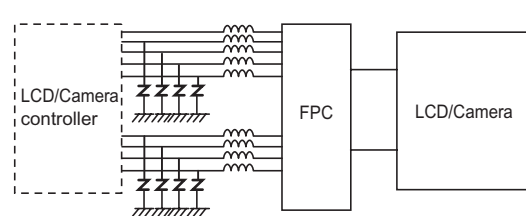

· I/O data lines

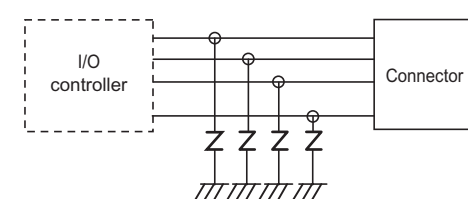

USB1.1/2.0 lines

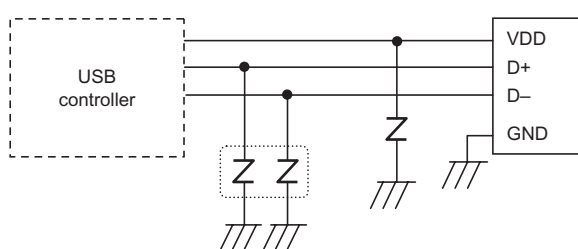

IEEE1394 lines

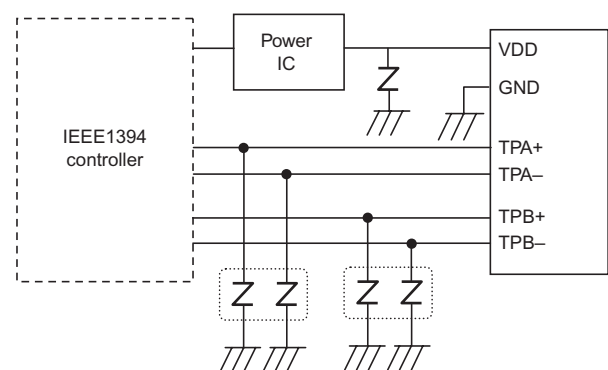

HDMI lines

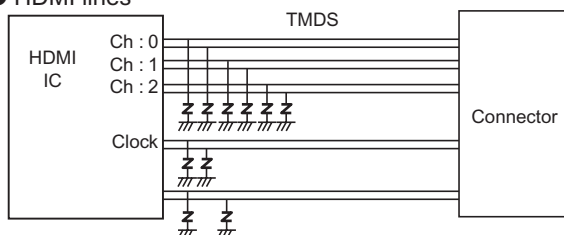

Performance and Testing Methods

Characteristics	Specifications	Testing Method															
Standard test conditions		Electrical characteristics shall be measured under the following conditions. Temp. : 5 to 35 °C, Relative humidity : 85 % or less															
Varistor voltage	To meet the specified value.	The voltage between both end terminals of a varistor when the specified measuring current (CmA) is applied to the Varistor (V _{c1} , or V _{CmA} .) The measurement shall be made as quickly as possible to avoid heating effects.															
Maximum allowable voltage	To meet the specified value.	The maximum DC voltage that can be applied continuously to a varistor															
Capacitance	To meet the specified value.	Capacitance shall be measured at the specified frequency, bias voltage 0 V, measuring voltage 0.2 to 2 Vrms.															
Maximum peak current	To meet the specified value.	The maximum current measured (while the varistor voltage is within ±10 % of its nominal value) when a standard impulse current of 8/20 μ seconds is applied twice within an interval of 5 minutes.															
Maximum ESD	To meet the specified value.	The maximum ESD measured (while the varistor voltage is within ±30 % of its nominal value) when exposed to ESD 10 times (five times for each positive-negative polarity) based on IEC61000-4-2.															
Solderability	To meet the specified value.	The part shall be immersed into a soldering bath under the conditions below. Solder: H63A Soldering flux : Ethanol solution of rosin (Concentration approx. 25 wt%) Soldering temp. : 230±5 °C Period : 4±1 s Soldering position: So that both terminal electrodes are completely immersed in the soldering bath															
Resistance to soldering heat	ΔVc / Vc : within ±10 %	The part shall be immersed into a soldering bath under the conditions below (before being subjected to standard conditions) for 24±2 hours to evaluate its characteristics. Soldering conditions : 270 °C, 3 s / 260 °C, 10 s Soldering position : So that both terminal electrodes are completely immersed in the soldering bath															
Temperature cycle	ΔVc / Vc : within ±10 %	Repeat the following cycle on the part for the specified number of times (before being subjected to standard conditions) for 24±2 hours to evaluate its characteristics. Cycle : 5 cycles <table border="1" style="margin-left: auto; margin-right: auto;"> <thead> <tr> <th>Step</th> <th>Temperature</th> <th>Period</th> </tr> </thead> <tbody> <tr> <td>1</td> <td>Max. Operating Temp.</td> <td>30±3 min</td> </tr> <tr> <td>2</td> <td>Ordinary temp.</td> <td>3 min max.</td> </tr> <tr> <td>3</td> <td>Min. Operating Temp.</td> <td>30±3 min</td> </tr> <tr> <td>4</td> <td>Ordinary temp.</td> <td>3 min max.</td> </tr> </tbody> </table>	Step	Temperature	Period	1	Max. Operating Temp.	30±3 min	2	Ordinary temp.	3 min max.	3	Min. Operating Temp.	30±3 min	4	Ordinary temp.	3 min max.
Step	Temperature	Period															
1	Max. Operating Temp.	30±3 min															
2	Ordinary temp.	3 min max.															
3	Min. Operating Temp.	30±3 min															
4	Ordinary temp.	3 min max.															
Damp heat load	ΔVc / Vc : within ±10 %	The part shall be tested under the conditions below (before being subjected to standard conditions) for 24±2 hours to evaluate its characteristics. Temp. : 40±2 °C Humidity : 90 to 95 %RH Applied voltage : Maximum allowable voltage (Individually specified) Period : 500+24 / 0 h															
High temperature load	ΔVc / Vc : within ±10 %	The part shall be tested under the conditions below (before being subjected to standard conditions) for 24±2 hours to evaluate its characteristics. Temp. : Maximum operating temperature ±3 °C (Individually specified) Applied voltage : Maximum allowable voltage (Individually specified) Period : 500+24 / 0h															

■ Packaging Specifications

● Standard Packing Quantity

Series	Size Code	Thickness (mm)	Paper Taping		Embossed Taping	
			Pitch (mm)	Q'ty (pcs./reel)	Pitch (mm)	Q'ty (pcs./reel)
EZJZ	0 (0402)	0.5	2	10,000	—	—
	1 (0603)	0.8	4	4,000	—	—
	S (0504 2Array)	0.6	4	4,000	—	—
EZJS	1(0603)	0.8	4	4,000	—	—
	2(0805)	0.8	4	5,000	—	—
		1.25	—	—	—	4

● Paper Taping

Pitch 2mm (Punched carrier) : 0402

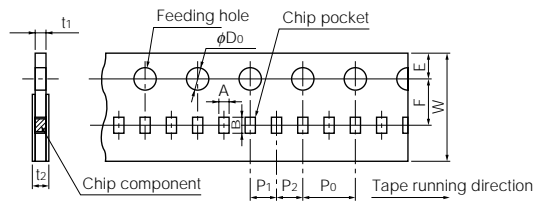

(Unit : mm)

Symbol	A	B	W	F	E	P ₁	P ₂	P ₀	φD ₀	t ₁	t ₂
Dim (mm)	0.62 ±0.05	1.12 ±0.05	8.0 ±0.2	3.50 ±0.05	1.75 ±0.10	2.00 ±0.05	2.00 ±0.05	4.0 ±0.1	1.5 ^{+0.1} ₀	0.7 max.	1.0 max.

Pitch 4mm (Punched carrier) : 0603, 0805, 0504/2Array

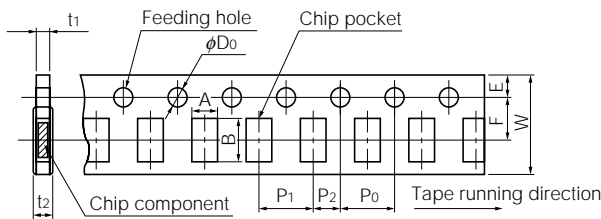

(Unit : mm)

Symbol	A	B	W	F	E	P ₁	P ₂	P ₀	φD ₀	t ₁	t ₂
1 (0603)	1.0 ±0.1	1.8 ±0.1									
S (0504 2 Array)	1.18 ±0.10	1.63 ±0.10	8.0 ±0.2	3.50 ±0.05	1.75 ±0.10	4.0 ±0.1	2.00 ±0.05	4.0 ±0.1	1.5 ^{+0.1} ₀	1.1 max.	1.4 max.
2 (0805)	1.65 ±0.20	2.4 ±0.2									

● Embossed Taping

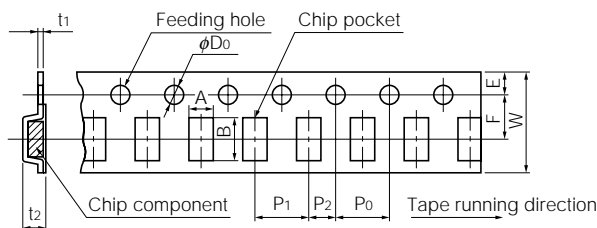

(Unit : mm)

Symbol	A	B	W	F	E	P ₁	P ₂	P ₀	φD ₀	t ₁	t ₂
Dim (mm)	1.55 ±0.20	2.35 ±0.20	8.0 ±0.2	3.50 ±0.05	1.75 ±0.10	4.0 ±0.1	2.00 ±0.05	4.0 ±0.1	1.5 ^{+0.1} ₀	0.6 max.	1.5 max.

● Reel for Taping

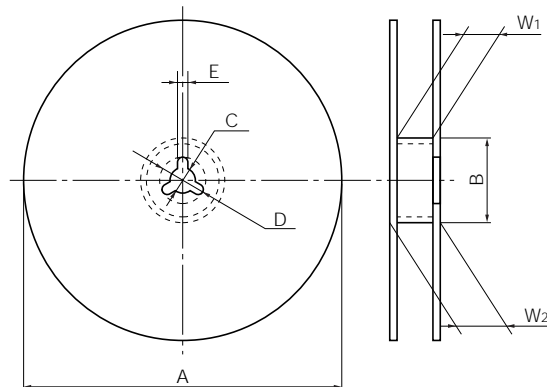

Symbol	A	B	C	D	E	W ₁	W ₂
Dim (mm)	φ180 ⁰ ₋₃	φ60.0 ±0.5	13.0 ±0.5	21.0 ±0.8	2.0 ±0.5	9.0 ±0.3	11.4 ±1.0

● Leader Part and Taped End

Leader part

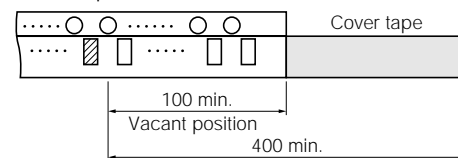

Tape end

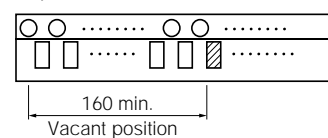

Dimensions in mm