

GENERAL DESCRIPTION

This document describes the specifications for the IDTF1100 Zero-Distortion™ RF to IF Downconverting Mixer. This device is part of a series of downconverting mixers covering all UTRA bands. See the Part# Matrix for the details of all devices in the series.

The F1100 dual channel device operates with a single 5V supply. It is optimized for operation in a Multi-carrier BaseStation Receiver for RF bands from 698 to 915 MHz with High Side Injection. IF frequencies from 150 to 450 MHz are supported. Nominally, the device offers +41 dBm Output IP3 with 350 mA of I_{CC} .

COMPETITIVE ADVANTAGE

In typical basestation receivers the mixer limits the linearity performance for the entire receive system. The F1100 with Zero-Distortion technology dramatically improves the maximum IM_3 interference that the BTS can withstand at a desired Signal to Noise Ratio (SNR.)

- ✓ $IP3_O$: \uparrow 7 dB
- ✓ Allows for higher RF gain improving **Sensitivity**



PART# MATRIX

| Part# | RF freq range | UTRA bands | IF freq range | Typ. Gain | Injection |
|-------|---------------|--|---------------|-----------|-----------|
| F1100 | 698 - 915 | 5,6,8,12,13,14,17,19,20 | 150 - 450 | 9 | High Side |
| F1102 | 400 - 1000 | 5,6,8,12,13,14,17,19,20 | 50 - 300 | 9.0 | Both |
| F1150 | 1700 - 2200 | 1,2,3,4,9,10,33,34,35,36,37,39 | 50 - 450 | 8.5 | High Side |
| F1152 | 1400 - 2200 | 1,2,3,4,9,10,21 ¹ ,24 ¹ ,33,34,35,36,37,39 | 50 - 350 | 8.5 | Low Side |
| F1162 | 2300 - 2700 | 7,38,40,41 | 50 - 500 | 8.8 | Both |

¹ - with High side injection

FEATURES

- Dual Path for Diversity Systems
- Ideal for Multi-Carrier Systems
- MIMO friendly: -6 dBm min LO drive
- 9 dB Gain
- Ultra linear: +41 dBm $IP3_O$ (350 MHz IF)
- Low NF \sim 10 dB
- 200 Ω output impedance
- Ultra high +13 dBm $P1dB_I$
- Pin Compatible w/Existing solutions
- 6x6 36 pin package
- Power Down mode
- Standard Mode: $I_{CC} = 350$ mA

DEVICE BLOCK DIAGRAM

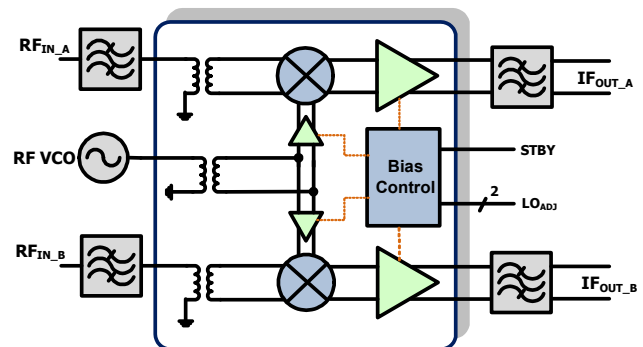

ORDERING INFORMATION

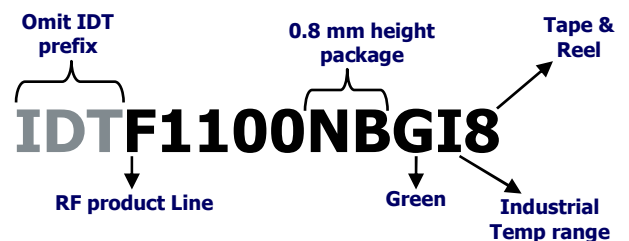

ABSOLUTE MAXIMUM RATINGS

| | |
|---|---|
| VCC to GND | -0.3V to +5.5V |
| STBY | -0.3V to (VCC_ + 0.3V) |
| IF_A+, IF_B+, IF_A-, IF_B-, LO1_ADJ, LO2_ADJ | -0.3V to (VCC_ + 0.3V) |
| LO_IN, LO_IN_ALT, RF_A, RF_B | -0.3V to +0.3V |
| IF_BiasA, IF_BiasB to GND | -0.3V to +0.3V |
| RF Input Power (RF_A, RF_B) | +20dBm |
| Continuous Power Dissipation | 2.2W |
| θ_{JA} (Junction – Ambient) | +35°C/W |
| θ_{JC} (Junction – Case) The Case is defined as the exposed paddle | +2.5°C/W |
| Operating Temperature Range (Case Temperature) | $T_C = -40^\circ\text{C}$ to $+100^\circ\text{C}$ |
| Maximum Junction Temperature | 150°C |
| Storage Temperature Range | -65°C to +150°C |
| Lead Temperature (soldering, 10s) . | +260°C |

Stresses above those listed above may cause permanent damage to the device. Functional operation of the device at these or any other conditions above those indicated in the operational section of this specification is not implied. Exposure to absolute maximum rating conditions for extended periods may affect device reliability.

IDTF1100 SPECIFICATION (698 – 915 MHz MIXER W/HIGH SIDE INJECTION)

Specifications apply at $V_{CC} = +5.0V$, $F_{RF} = 850 \text{ MHz}$, $F_{IF} = 350\text{MHz}$, Hi-Side Inj., $P_{LO} = 0 \text{ dBm}$, $T_{CASE} = +25^{\circ}\text{C}$, $STBY = GND$, Trace and Transformer Losses de-embedded unless otherwise noted.

| Parameter | Comment | Symbol | min | typ | max | units |
|-----------------------|--|------------------|------------|--------------|------------|---------------|
| Logic Input High | For Standby Pin | V_{IH} | 2 | | | V |
| Logic Input Low | For Standby Pin | V_{IL} | | | 0.8 | V |
| Logic Current | For Standby Pin | I_{IH}, I_{IL} | -5 | | +5 | μA |
| Supply Voltage(s) | All V_{CC} pins | V_{CC} | | 4.75 to 5.25 | | V |
| Operating Temperature | Case Temperature | T_{CASE} | | -40 to +100 | | degC |
| Supply Current | Total V_{CC} Both Channels | I_{STD} | | 350 | 395 | mA |
| Supply Current | Standby Mode <ul style="list-style-type: none"> ▪ $STBY = V_{IH}$ ▪ Total Both Channels | I_{STBY} | | 28 | 35 | mA |
| RF Freq Range | Operating Range | F_{RF} | | 698 to 915 | | MHz |
| IF Freq Range | Operating Range | F_{IF} | | 150 to 450 | | MHz |
| LO Freq Range | Operating Range | F_{LO} | | 848 to 1365 | | MHz |
| LO Power | Operating Range | P_{LO} | | -6 to +6 | | dBm |
| RF Input Impedance | Single Ended <i>Return Loss > 15 dB</i> | Z_{RF} | | 50 | | Ω |
| IF Output Impedance | Differential <i>Return Loss > 15 dB</i> | Z_{IF} | | 200 | | Ω |
| LO port Impedance | Single Ended <i>Return Loss > 15 dB</i> | Z_{LO} | | 50 | | Ω |
| Gain (low freq) | Conversion Gain <ul style="list-style-type: none"> • $F_{RF} = 698 \text{ MHz}$ • $F_{IF} = 450 \text{ MHz}$ • EVB trace and transformer loss = 0.9 dB | G_1 | 7.8 | 8.9 | 10 | dB |
| Gain (high freq) | Conversion Gain <ul style="list-style-type: none"> • $F_{RF} = 915 \text{ MHz}$ • $F_{IF} = 350 \text{ MHz}$ • EVB trace and transformer loss = 0.8 dB | G_2 | 8.0 | 9.0 | 10 | dB |

IDTF1100 SPECIFICATION (CONTINUED)

| Parameter | Comment | Symbol | min | typ | max | units |
|-------------------------|---|------------|------|------|-----|-------|
| Noise Figure | <ul style="list-style-type: none"> • $F_{RF} = 850$ MHz • $F_{IF} = 350$ MHz | NF_{STD} | | 10 | | dB |
| NF w/Blocker | <ul style="list-style-type: none"> ▪ 50 MHz offset blocker ▪ $P_{IN} = +10$ dBm ▪ $F_{IF} = 350$ MHz ▪ $F_{RF} = 900$ MHz | NF_{BLK} | | 20.3 | | dB |
| Output IP3 – Narrowband | <ul style="list-style-type: none"> ▪ $P_{IN} = -10$ dBm per tone ▪ 800 KHz Tone Separation ▪ $F_{IF} = 350$ MHz ▪ $F_{RF} = 850$ MHz | $IP3_{O1}$ | 38 | 41 | | dBm |
| Output IP3 – Wideband | <ul style="list-style-type: none"> ▪ $P_{IN} = -10$ dBm per tone ▪ 15 MHz Tone Separation ▪ $F_{IF} = 350$ MHz | $IP3_{O2}$ | | 41 | | dBm |
| 2RF X 2LO rejection | <ul style="list-style-type: none"> ▪ $P_{RF} = -10$ dBm ▪ $F_{IF} = 350$ MHz ▪ $F_{LO} = 1200$ MHz ▪ $F_{SPUR} = F_{LO} - \frac{1}{2} F_{IF}$ | 2x2 | | -80 | | dBc |
| 3RF X 3LO rejection | <ul style="list-style-type: none"> ▪ $P_{RF} = -10$ dBm ▪ $F_{IF} = 350$ MHz ▪ $F_{LO} = 1200$ MHz ▪ $F_{SPUR} = F_{LO} - \frac{1}{3} F_{IF}$ | 3x3 | | -82 | | dBc |
| 1 dB Compression | <ul style="list-style-type: none"> ▪ Input referred ▪ $F_{IF} = 350$ MHz | $P1dB_I$ | 12.4 | 13.1 | | dBm |
| Channel Isolation | IF_B Pout vs. IF_A w/ RF_A input | ISO_C | | 60 | | dB |
| LO to IF leakage | | ISO_{LI} | | -19 | -13 | dBm |
| RF to IF leakage | $P_{in} = -10$ dBm | ISO_{RI} | | -39 | -33 | dBm |
| LO to RF leakage | | ISO_{LR} | | -40 | | dBm |

1 – Items in min/max columns in ***bold italics*** are Guaranteed by Test

2 – All other Items in min/max columns are Guaranteed by Design Centering

TYPICAL OPERATING CONDITIONS
Unless Otherwise Noted:

- Dotted Lines: 450 MHz IF / Solid Lines: 350 MHz IF
- High Side Injection
- 800 KHz Channel Spacing
- Average of ChA, ChB
- $P_{in} = -10$ dBm
- Trace & Transformer Losses de-embedded

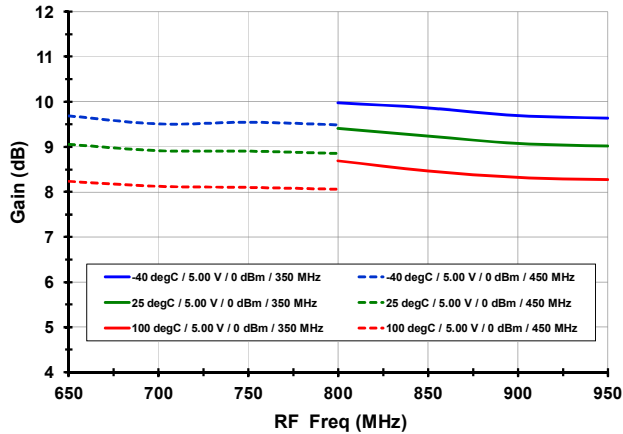
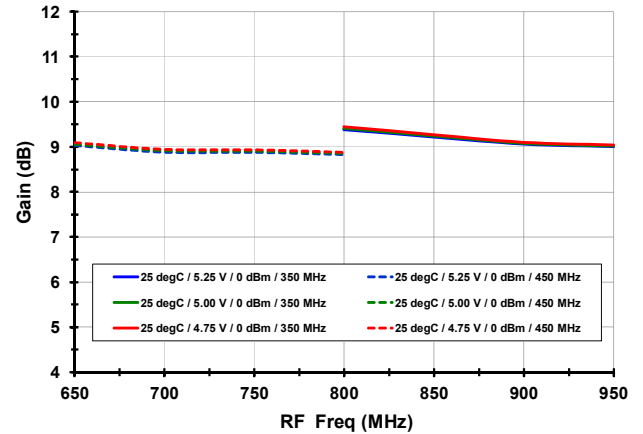
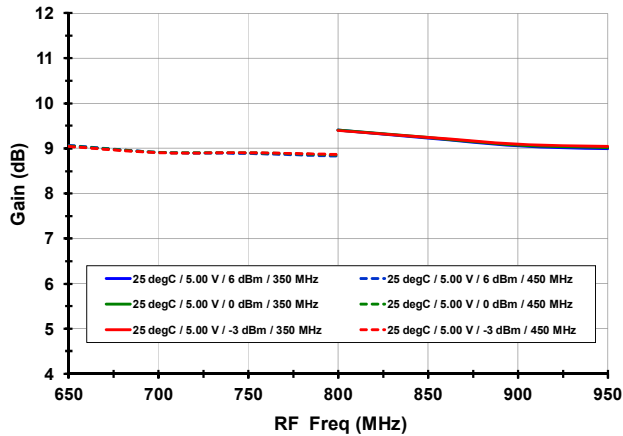
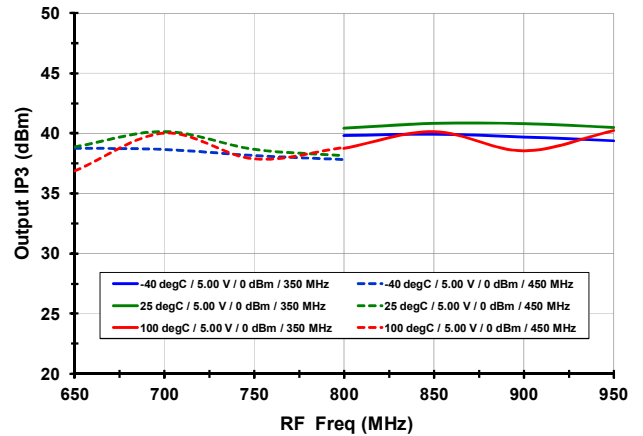
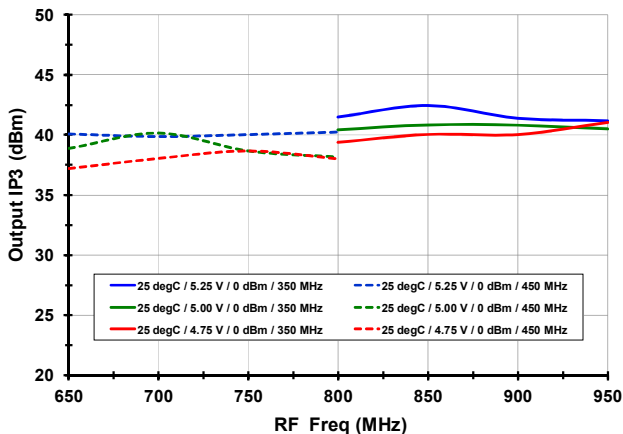
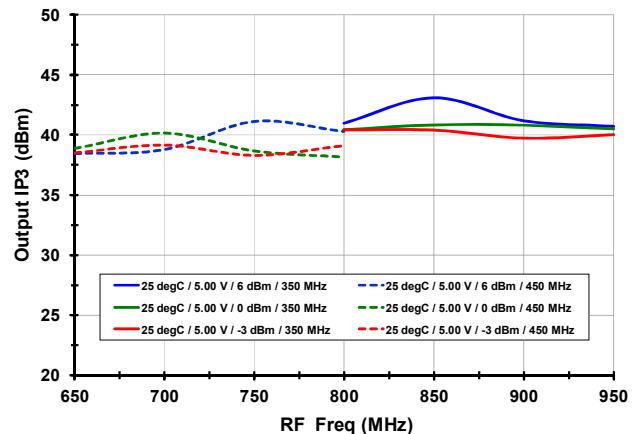
TYPICAL OPERATING CONDITIONS (-1-)
Gain vs. T_{CASE}

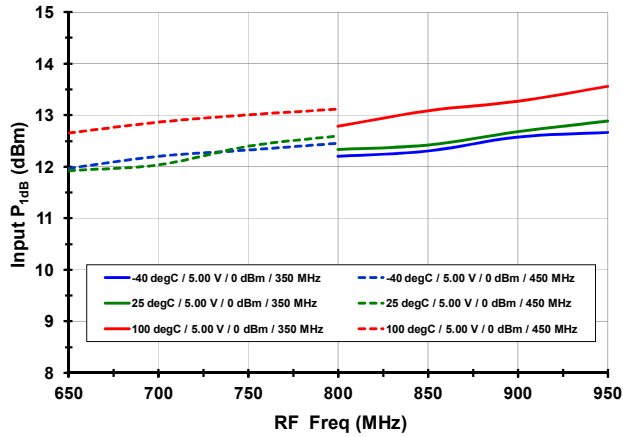
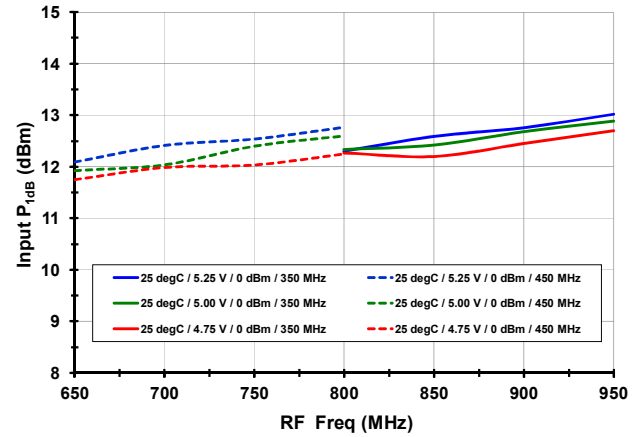
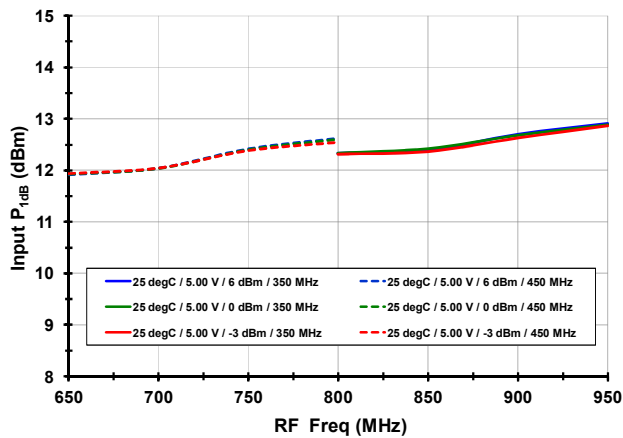
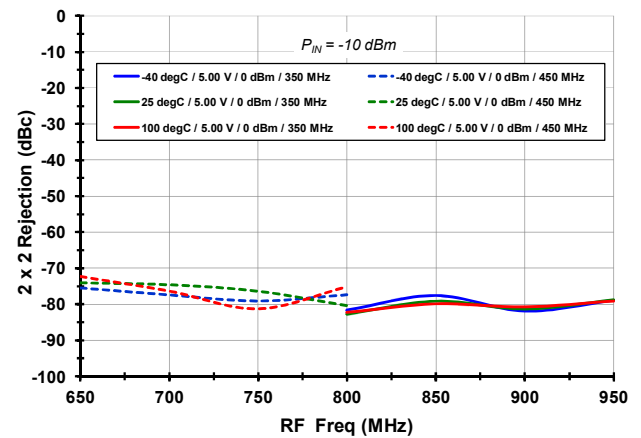
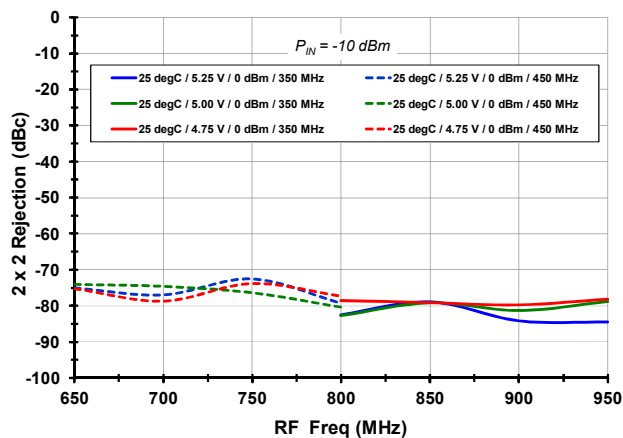
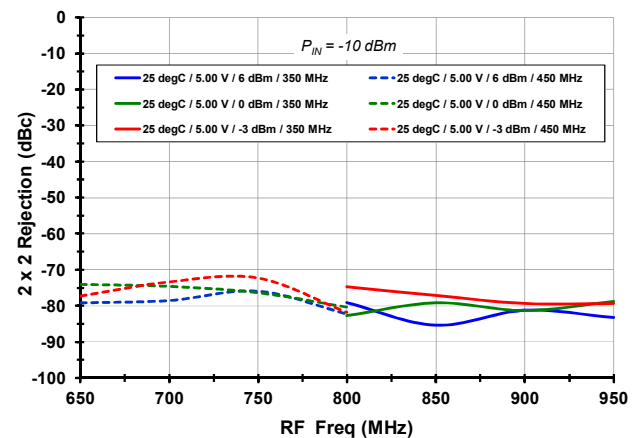
Gain vs. V_{CC}

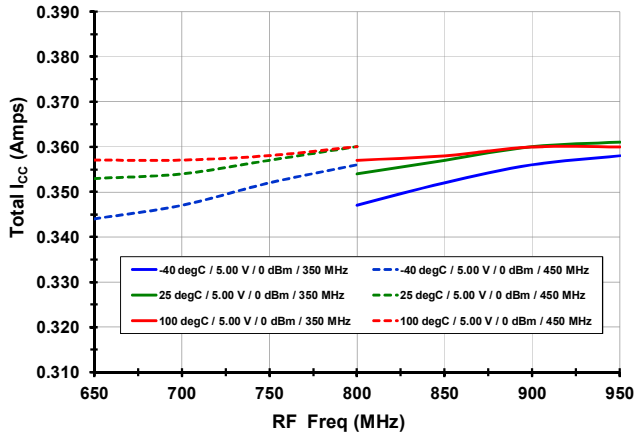
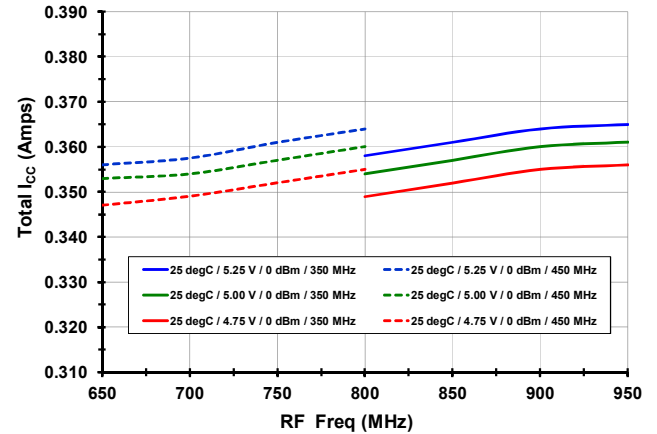
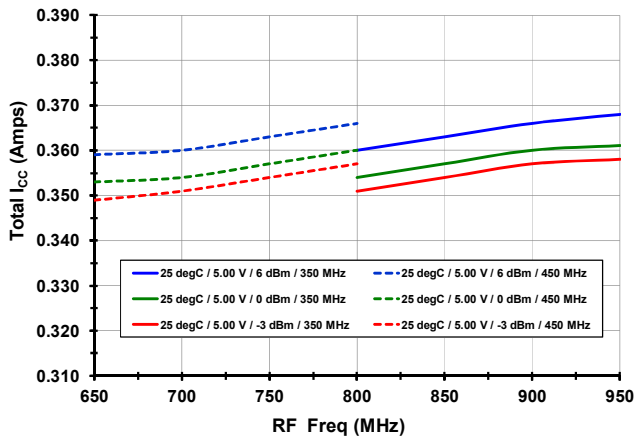
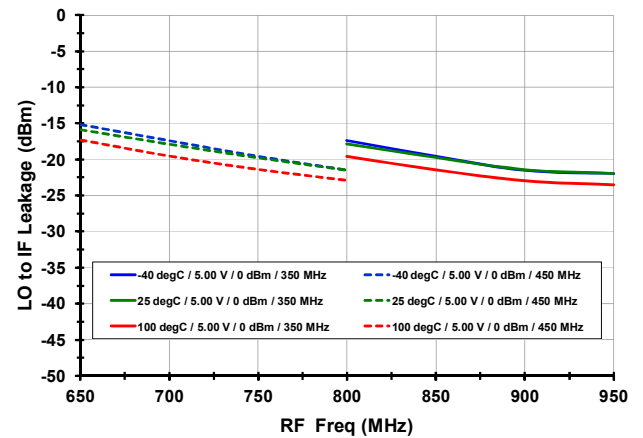
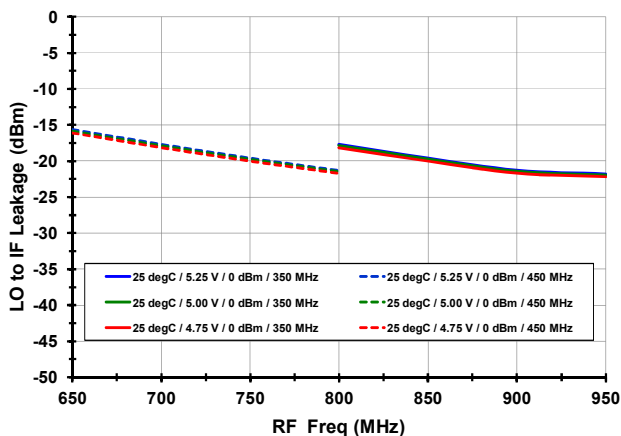
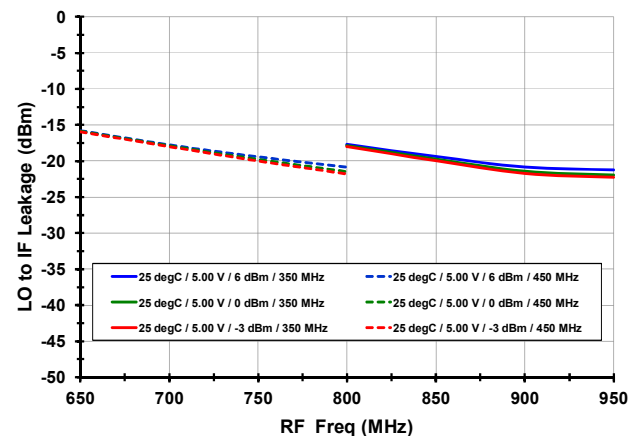
Gain vs. LO Level

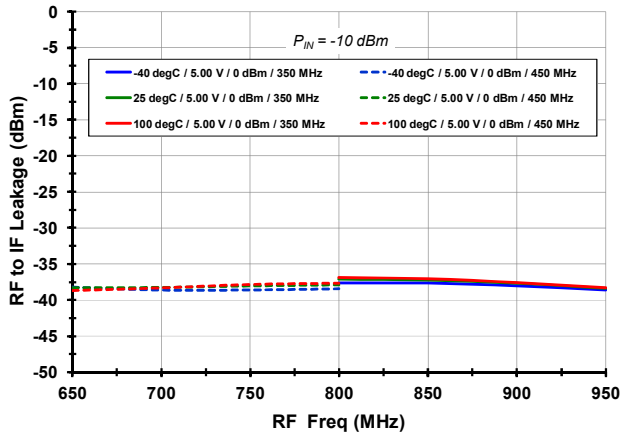
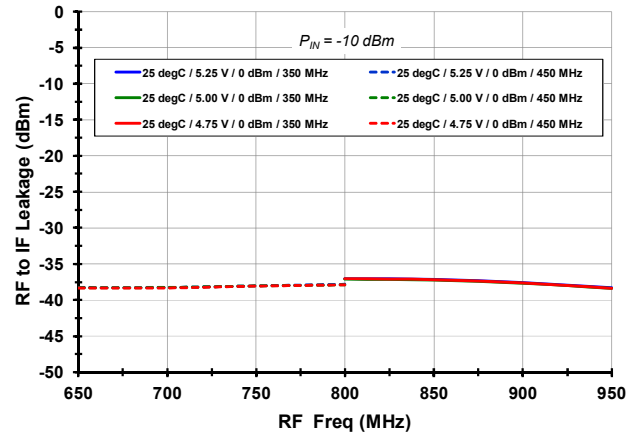
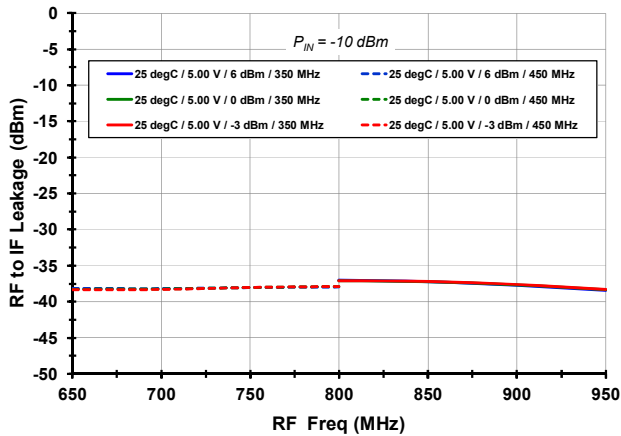
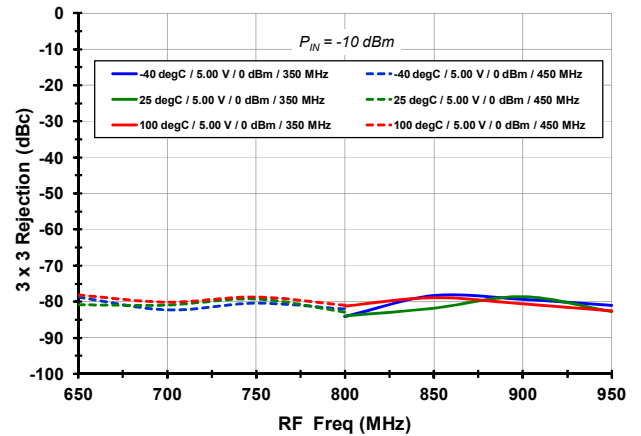
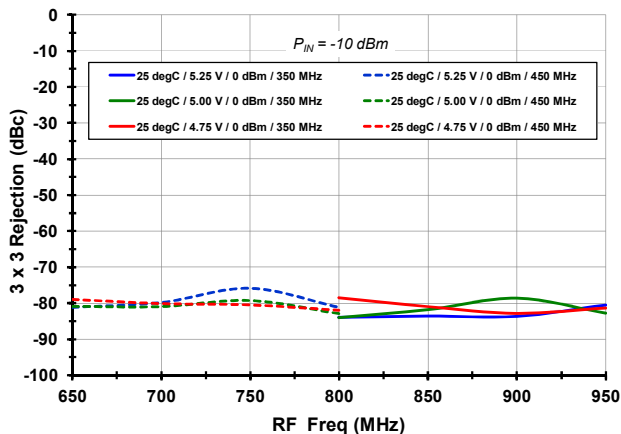
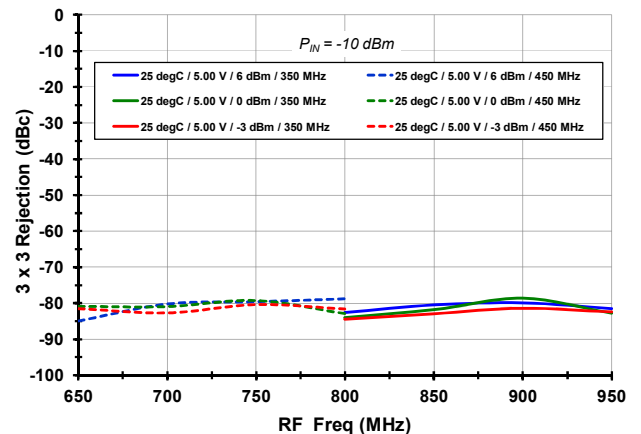
Output IP3 vs. T_{CASE}

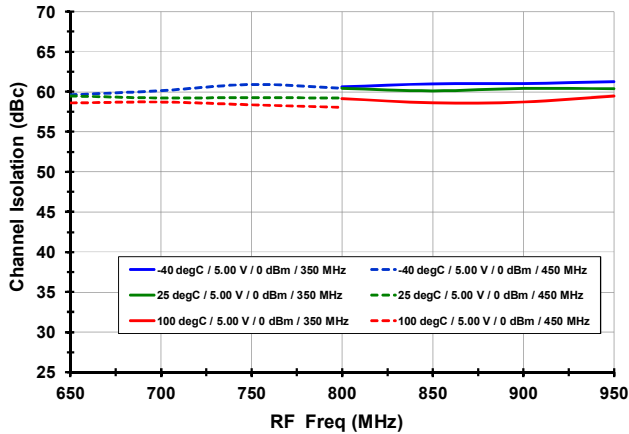
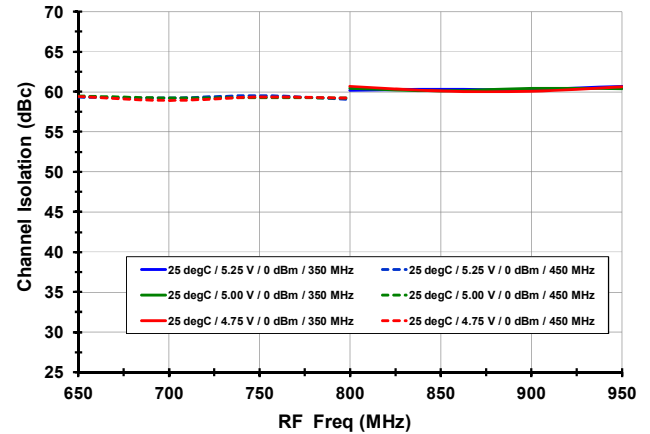
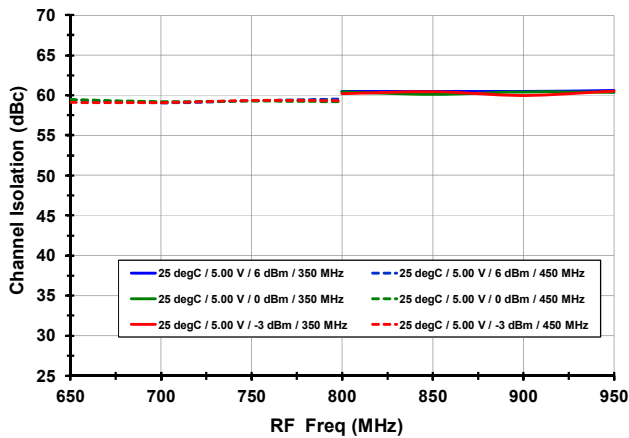
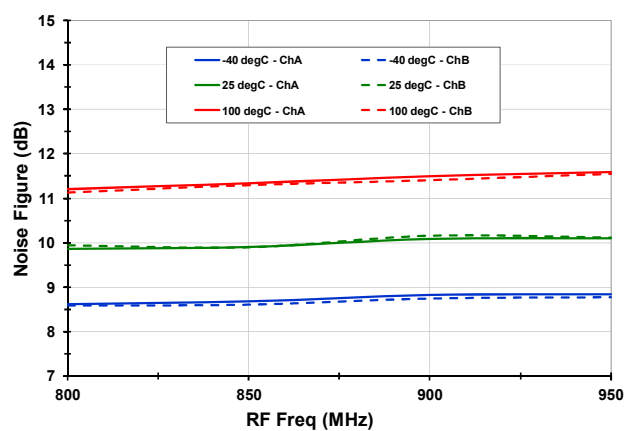
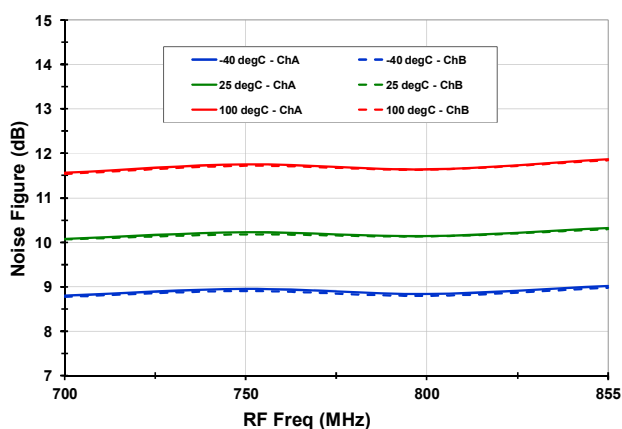
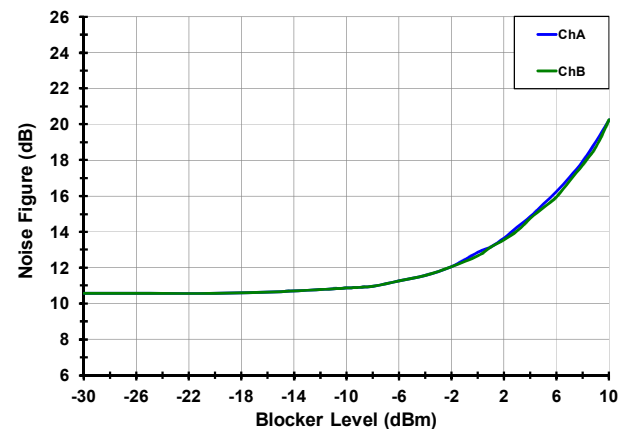
Output IP3 vs. V_{CC}

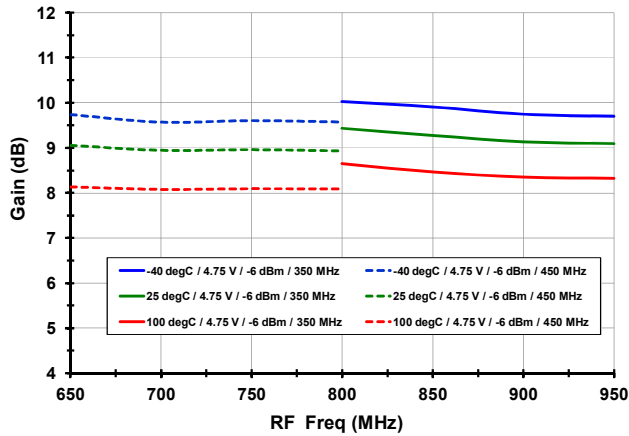
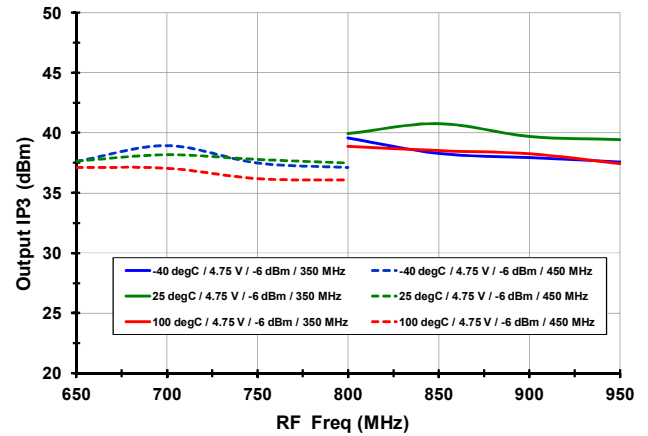
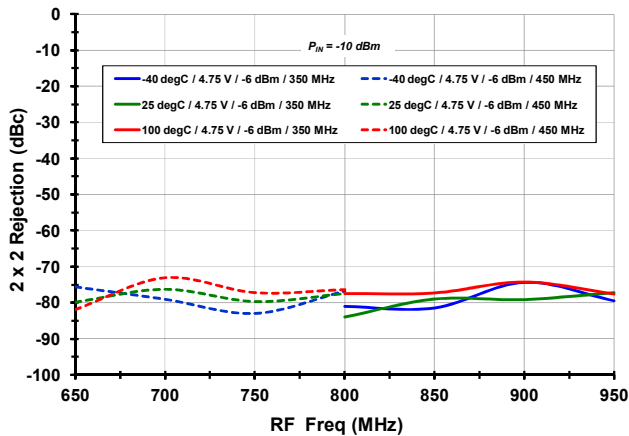
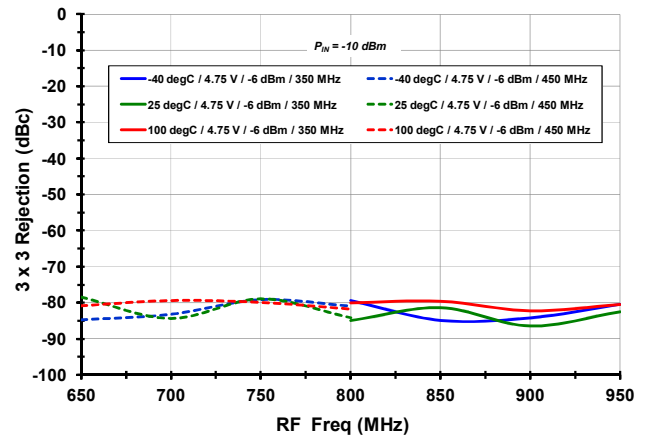
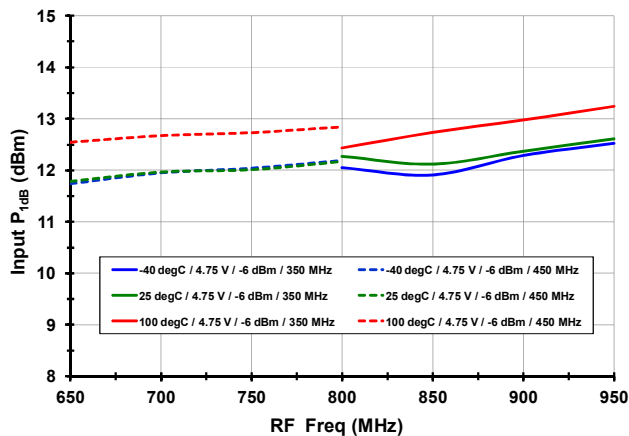
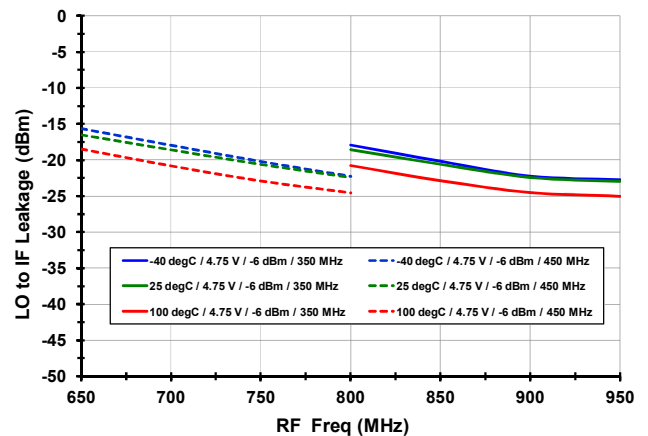
Output IP3 vs. LO Level

TYPICAL OPERATING CONDITIONS (-2-)
P1dB vs. T_{CASE}

P1dB vs. V_{CC}

P1dB vs. LO Level

2RF x 2LO rejection vs. T_{CASE}

2RF x 2LO Rejection vs. V_{CC}

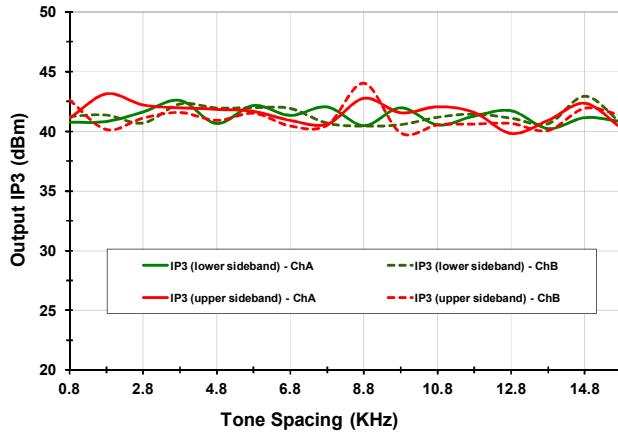
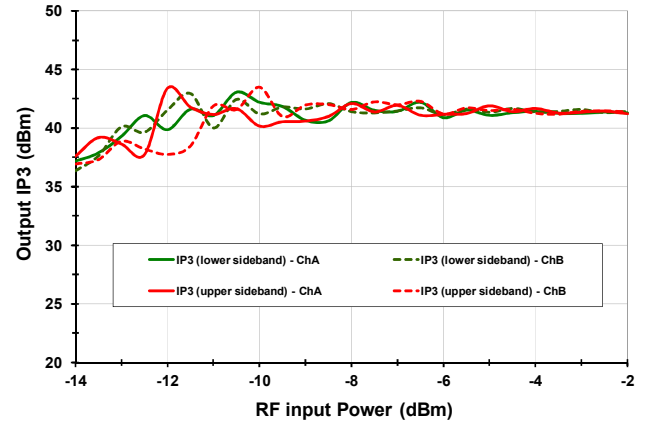
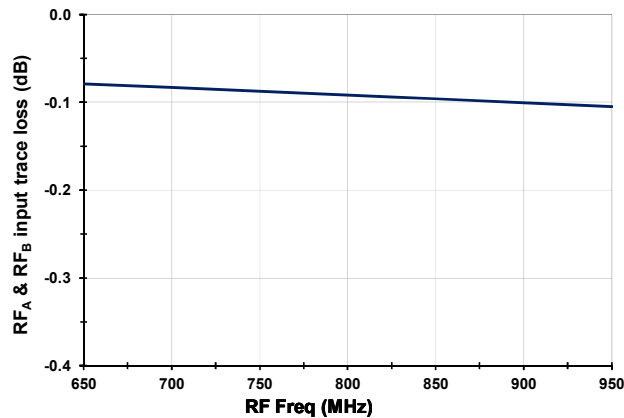
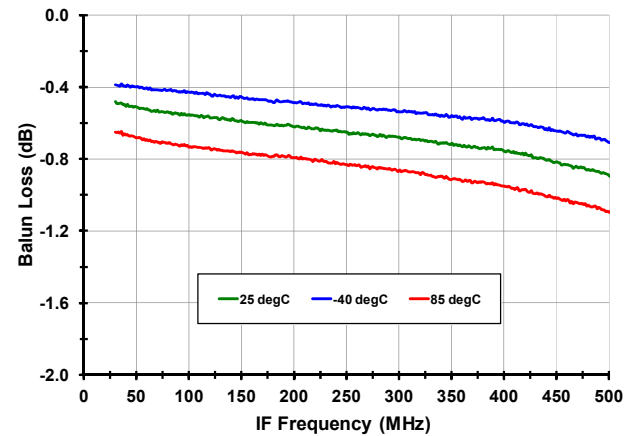
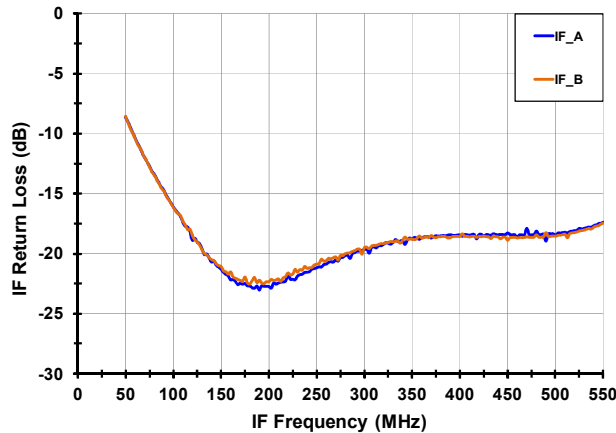
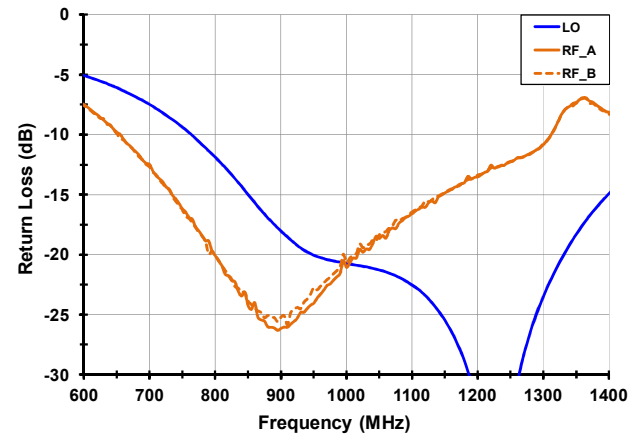
2RF x 2LO Rejection vs. LO Level

TYPICAL OPERATING CONDITIONS (-3-)
I_{CC} vs. T_{CASE}

I_{CC} vs. V_{CC}

I_{CC} vs. LO Level

LO-IF Leakage vs. T_{CASE}

LO-IF Leakage vs. V_{CC}

LO-IF Leakage vs. LO Level

TYPICAL OPERATING CONDITIONS (-4-)
RF-IF Leakage vs. T_{CASE}

RF-IF Leakage vs. V_{CC}

RF-IF Leakage vs. LO Level

3RF X 3LO Rejection vs. T_{CASE}

3RF X 3LO Rejection vs. V_{CC}

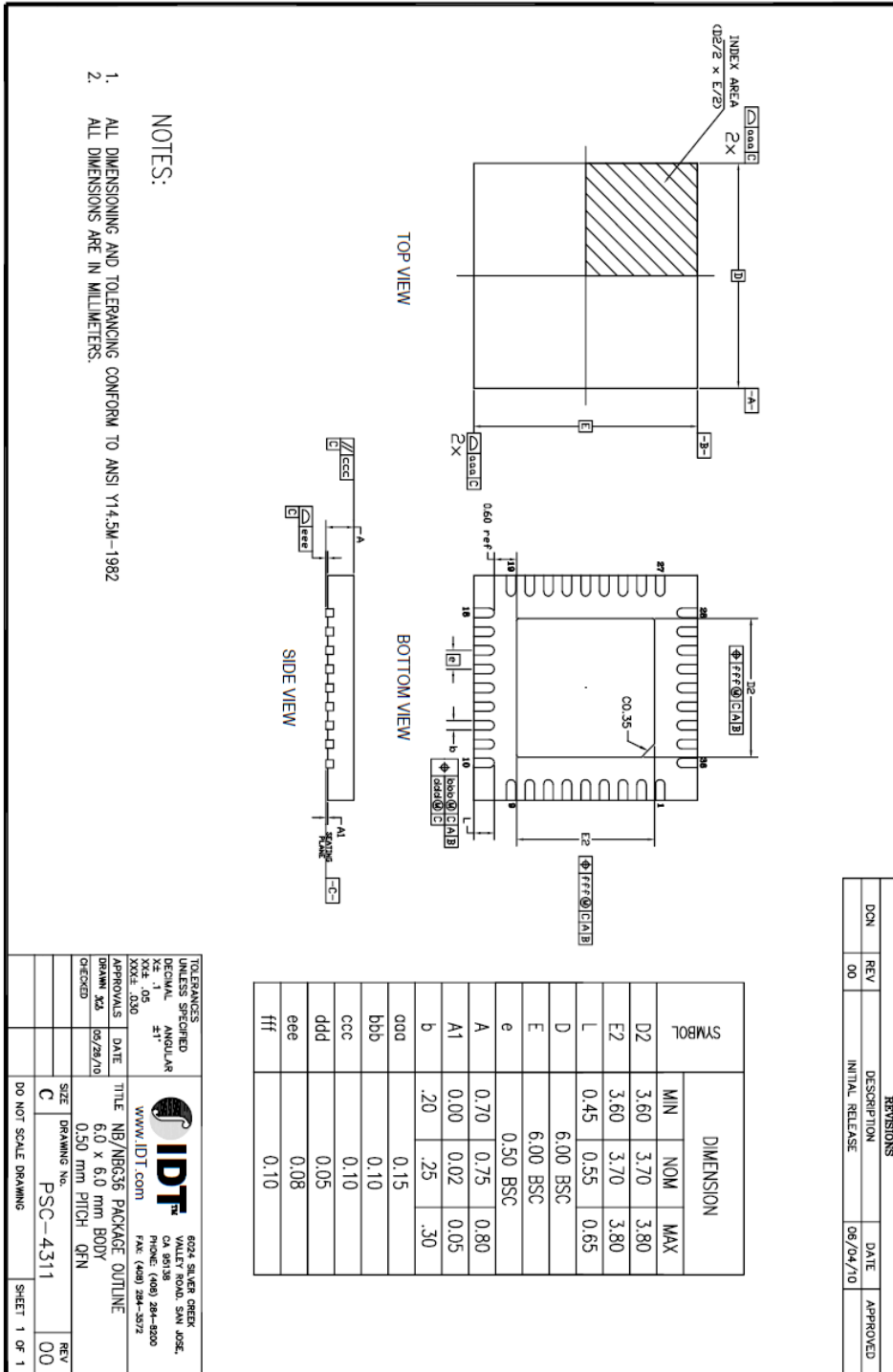
3RF X 3LO Rejection vs. LO Level

TYPICAL OPERATING CONDITIONS (-5-)
Channel Isolation vs. T_{CASE}

Channel Isolation vs. V_{CC}

Channel Isolation vs. LO Level

Noise Figure vs. T_{CASE} (350 MHz IF, RF trace de-embedded)

Noise Figure vs. T_{CASE} (450 MHz IF, RF trace de-embedded)

NF vs. Blocker (RF = 900 MHz, IF = 350 MHz, $T_A = 25C$)

RF to IF Dual Downconverting Mixer
698 - 915 MHz F1100NBGI
TYPICAL OPERATING CONDITIONS [*Extreme Conditions: low Supply, low LO level -6 dBm*] **(-6-)**
Gain

Output IP3

2x2 Rejection

3x3 Rejection

Input P1dB

LO to IF Leakage

TYPICAL OPERATING CONDITIONS [General] (-7-)
IP_{3O} vs. Δf ($T_A = 25C$, Freq = 850 MHz, IF = 350 MHz)

IP_{3O} vs. P_{IN} ($T_A = 25C$, Freq = 850 MHz, IF = 350 MHz)

EVkit Input RF Trace Loss ($T_A = 25C$)

TC4-6T Transformer Loss

EVkit IF Port Match ($T_A = 25C$)

EVkit RF & LO Port Match ($T_A = 25C$)

PACKAGE DRAWING (6X6 QFN)



| REVISIONS | | | |
|-----------|-----|-----------------|----------|
| DCN | REV | DESCRIPTION | DATE |
| 00 | | INITIAL RELEASE | 08/04/10 |

| | | | |
|-----------------------------|-------------|---------------------------|--------------|
| TOLERANCES UNLESS SPECIFIED | | 6024 SILVER GREEK | |
| DECIMAL | ANGULAR | MILLET RND. 5th POS. | |
| XX.X | ±1° | C/O PHONE: (408) 284-8000 | |
| XX.XX | ±1° | FAX: (408) 284-5072 | |
| XX.XXX | ±1° | WWW.IDT.COM | |
| APPROVALS | DATE | TITLE | |
| DRAWN XA | 05/28/10 | NB/NBGS6 PACKAGE OUTLINE | |
| CHECKED | | 6.0 x 6.0 mm BODY | |
| | | 0.50 mm PITCH OPEN | |
| SIZE | DRAWING NO. | REV | |
| C | PSC-4311 | 00 | |
| DO NOT SCALE DRAWING | | | SHEET 1 OF 1 |

PINOUTS

Black Text denotes recommended external connection

Red Text denotes internal Function or Connection

- DB GND = Downbonded to Paddle
- Internal NC = Pin not connected

Please Note!

- Only connect to one LO feed
- Choose Either Pin 19 or Pin 27
- Do not connect the unused LO pin to ensure good LO return loss

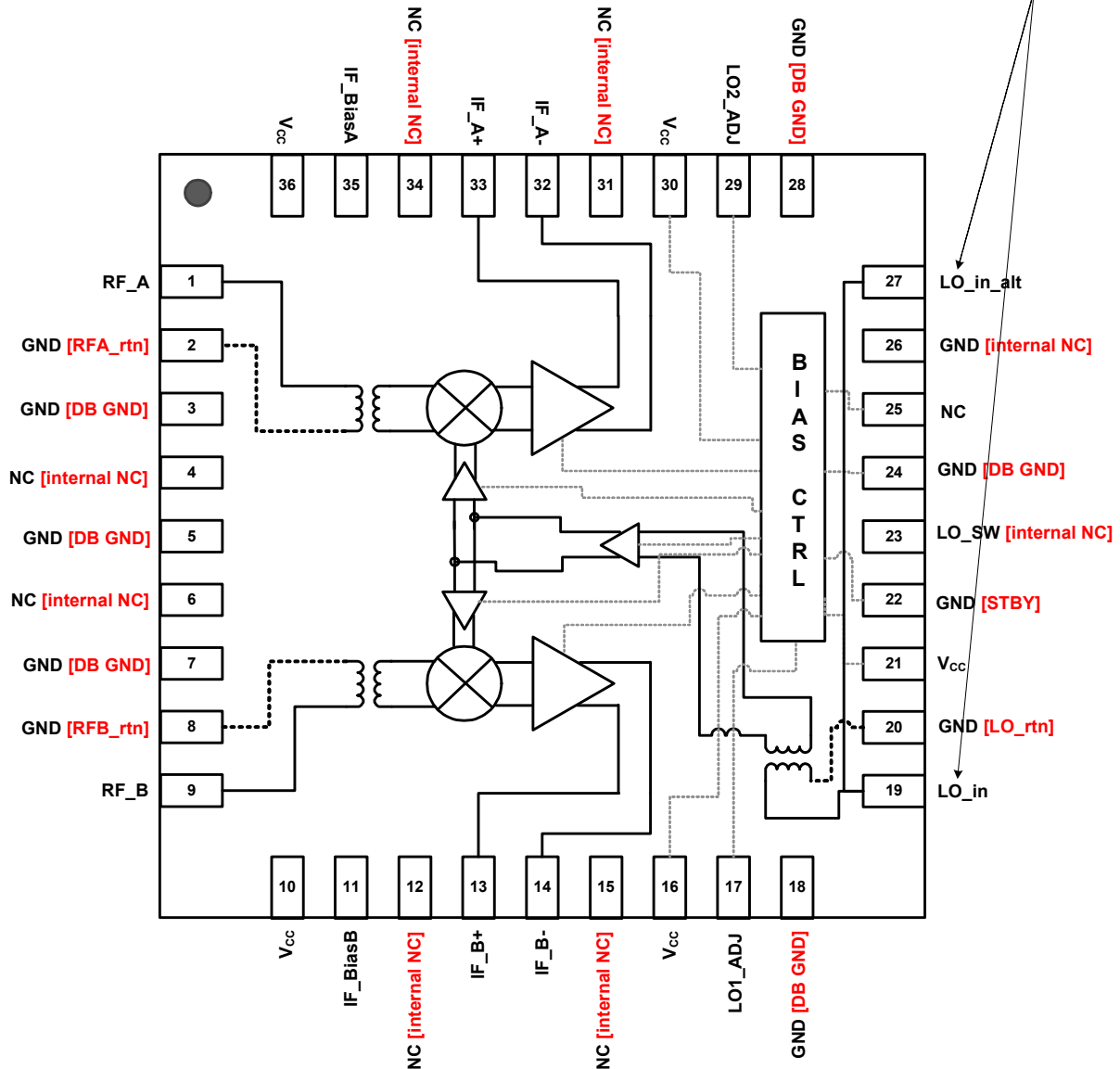

PIN DESCRIPTIONS

| Pin | Name | Function |
|---------------------------------|-----------------------------|--|
| 1 | RF_A | Main Channel RF Input. Internally matched to 50Ω. DO NOT apply DC to these pins |
| 2, 8, 20 | RF_Artn, RF_Brtn, LO_rtn | Transformer Ground Returns. Ground these pins. |
| 3, 5, 7, 18, 24, 28 | GND | Ground these pins. |
| 4, 6, 12, 15, 31, 23, 26, 34 | N.C. | No Connection. Not internally connected. OK to connect to Vcc. OK to connect to GND |
| 10, 16, 21, 30, 36 | VCC | Power Supply. Bypass to GND with capacitors shown in the Typical Application Circuit as close as possible to pin. |
| 9 | RF_B | Diversity Channel RF Input. Internally matched to 50Ω |
| 11 | IF_BiasB | Connect the specified resistor from this pin to ground to set the bias for the Diversity IF amplifier. This is NOT a current set resistor |
| 13, 14 | IFB+, IFB- | Diversity Mixer Differential IF Output. Connect pullup inductors from each of these pins to VCC (see the Typical Application Circuit). |
| 17 | LO1_ADJ | Connect the specified resistor for either Standard or LC mode from this pin to ground to set the LO common buffer Icc |
| 19, 27 | LO_in LO_in_alt | Local Oscillator Input. Connect the LO to this port through the recommended coupling capacitor. Note that you can only drive one LO port at a time. Remove the series capacitor from the unused port. |
| 25 | NC | Make Certain this pin is not connected. It is normally reserved for selecting <i>low current</i> mode which the F1100 does not offer |
| 22 | STBY | STBY Mode. Pull this pin high for Standby mode (~28 mA). Pull low or Ground for normal Operation |
| 29 | LO2_ADJ | Connect the specified resistor for either Standard or LC mode from this pin to ground to set the LO drive buffers Icc |
| 32, 33 | IFA-, IFA+ | Main Mixer Differential IF Output. Connect pullup inductors from each of these pins to VCC (see the Typical Application Circuit). |
| 35 | IF_BiasA | Connect the specified resistor from this pin to ground to set the bias for the Main IF amplifier. This is NOT a current set resistor |
| | — EP | Exposed Pad. Internally connected to GND. Solder this exposed pad to a PCB pad that uses multiple ground vias to provide heat transfer out of the device into the PCB ground planes. These multiple via grounds are also required to achieve the noted RF performance. |
| | | |

EVKIT SCHEMATIC

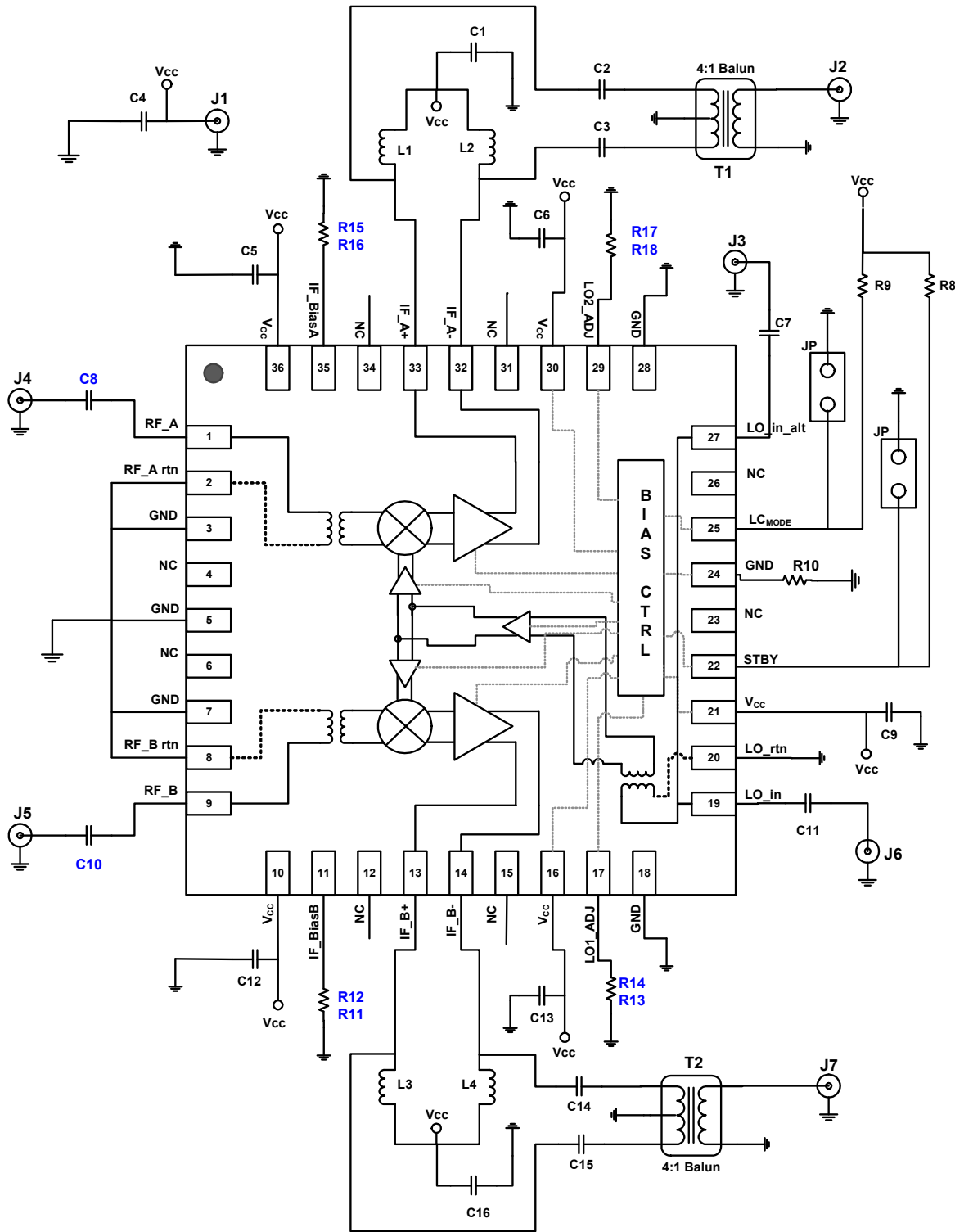

EVKIT PICTURE/LAYOUT/OPERATION

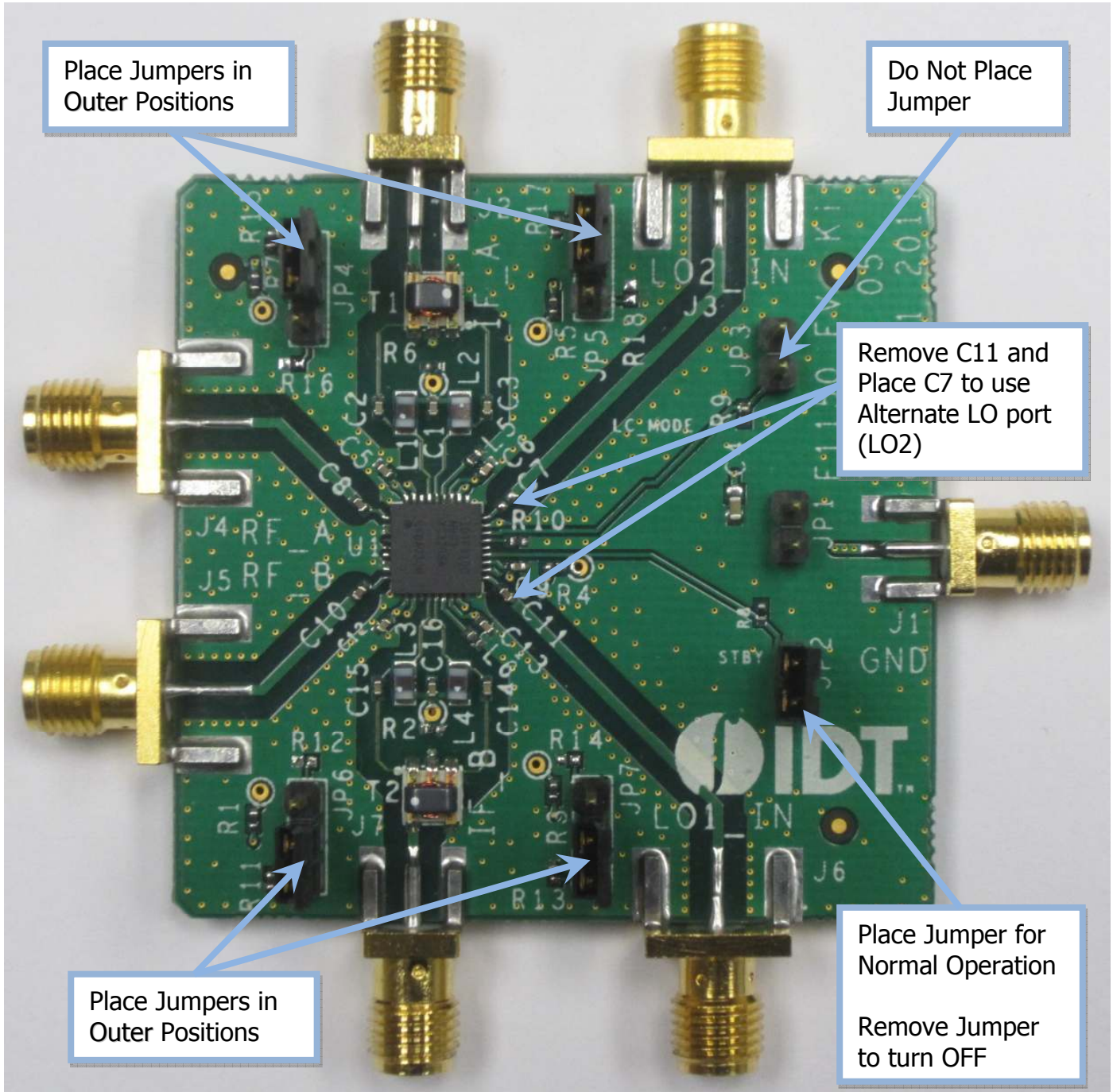

EVKIT BOM

For Normal Operation, Make sure the LC_{MODE} jumper is open and that the dual jumpers are set to the outer position.

F1100 PCB Rev 5 BOM Rev 02

| Item # | Value | Size | Desc | Mfr. Part # | Mfr. | Part Reference | Qty |
|--------|----------------|---|-------------------------------------|--------------------|-----------------|-------------------|-----|
| 1 | 10nF | 0402 | CAP CER 10000PF 16V 10% X7R 0402 | GRM155R71C103KA01D | MURATA | C1,5,6,9,12,13,16 | 7 |
| 2 | 1000pF | 0402 | CAP CER 1000PF 50V C0G 0402 | GRM1555C1H102JA01D | MURATA | C2,3,14,15 | 4 |
| 3 | 150pF | 0402 | CAP CER 150PF 50V C0G 0402 | GRM1555C1H151JA01D | MURATA | C8,10,11 | 3 |
| 4 | 150pF | NOTE: C7 and C11 cannot be installed together. C7 for Pin27 LO feed. C11 for Pin19 LO feed | | | | C7 | 1 |
| 5 | 10uF | 0603 | CAP CER 10UF 6.3V X5R 0603 | GRM188R60J106ME47D | MURATA | C4 | 1 |
| 6 | Header 2 Pin | TH 2 | CONN HEADER VERT SGL 2POS GOLD | 961102-6404-AR | 3M | JP1,2,3 | 3 |
| 7 | Header 3 Pin | TH 3 | CONN HEADER VERT SGL 3POS GOLD | 961103-6404-AR | 3M | JP4,5,6,7 | 4 |
| 8 | SMA_END_LAUNCH | .062 | SMA_END_LAUNCH (Small) | 142-0711-821 | Emerson Johnson | J1,2,7 | 3 |
| 9 | SMA_END_LAUNCH | .062 | SMA_END_LAUNCH (Big) | 142-0701-851 | Emerson Johnson | J3,4,5,6 | 4 |
| 10 | 270nH | 0805 | 0805CS (2012) Ceramic Chip Inductor | 0805CS-271XJLB | COILCRAFT | L1,2,3,4 | 4 |
| 11 | 20 | 0402 | RES 20 OHM 1/10W 1% 0402 SMD | ERJ-2RKF27R0X | Panasonic | R11,15 | 2 |
| 12 | 40.2 | 0402 | RES 40.2 OHM 1/10W 1% 0402 SMD | ERJ-2RKF40R2X | Panasonic | R13 | 1 |
| 13 | 1.21K | 0402 | RES 1.21K OHM 1/10W 1% 0402 SMD | ERJ-2RKF1211X | Panasonic | R17 | 1 |
| 14 | 47K | 0402 | RES 47.0K OHM 1/16W 1% 0402 SMD | RC0402FR-0747KL | Yageo | R8,9 | 2 |
| 15 | 0 | 0402 | RES 0.0 OHM 1/10W 0402 SMD | ERJ-2GE0R00X | Panasonic | R1,2,3,4,5,6,7,10 | 8 |
| 16 | 4:1 Balun | SM-22 | 4:1 Center Tap Balun | TC4-6TG2+ | Mini Circuits | T1,2 | 2 |
| 17 | F1100 | QFN-36 | DUAL RF MIXER | F1100NBGI | IDT | U1 | 1 |
| 18 | PCB | | EV Kit | F11XXEV Kit Rev 05 | | | 1 |

Total 52

TOPMARKINGS
