



Exhaust cleaner

# FA Series

www.DataSheet4U.com

Reducing exhaust noise and removing oil mist.

Port size: Rc3/8 to Rc2

JIS symbol



## Specifications

Descriptions	FA331-10A	FA431-15A	FA531-20A	FA631-25A	FA731-40A	FA831-50A
Port size Rc	3/8	1/2	3/4	1	1 1/2	2
Effective sectional area mm <sup>2</sup>	16	33	55	165	330	550
Max. flow rate m <sup>3</sup> /min(ANR)	0.3	0.6	1	3	6	10
Max. working temperature	65 °C					
Damping effect	35dB and over					
Oil mist collection ratio	99.9% and over					
Oil storage capacity cm <sup>3</sup>	80	130	150	250	350	550
Product mass kg	0.2	0.3	0.4	0.6	1.1	1.5
Bracket number (option)	B351-10A	B451-15A	B551-20A	B651-25A	—	—

## Flow characteristics

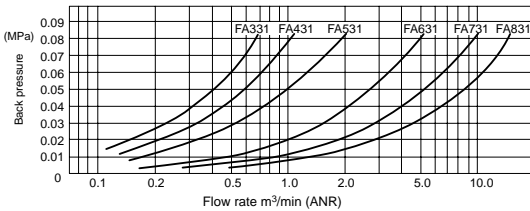

## Selection guide

For exhaust cleaner, select a model depending on air consumption in the used circuit.

- (1) Calculate air consumption of the used actuator.
- (2) Multiply the air consumption calculated by 1.4.
- (3) Select a model whose treating flow rate exceeds air consumption multiplied by 1.4.

The following diagram shows air consumption multiplied by 1.4 per air cylinder size. Use this diagram to select a model.

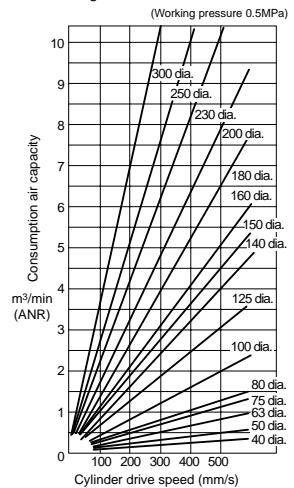

## How to order



**A** Series code

**B** Port size  
Note 1

**C** Option  
Note 2

Symbol	Descriptions
<b>A Series code</b>	
3	Compact
4	Standard
5	Large
6	Large
7	Large bore size
8	Large bore size
<b>B Port size</b>	
	Series
10A	Rc3/8
15A	Rc1/2
20A	Rc3/4
25A	Rc1
40A	Rc1 1/2
50A	Rc2
<b>C Option</b>	
B	Bracket

### ⚠ Note on model No. selection

Note 1: If NPT port is required, do not indicate nominal size A. (E.g.) FA431-15

Note 2: For FA731 and FA831, bracket option is not available.

www.DataSheet4U.com

## Internal structure and parts list

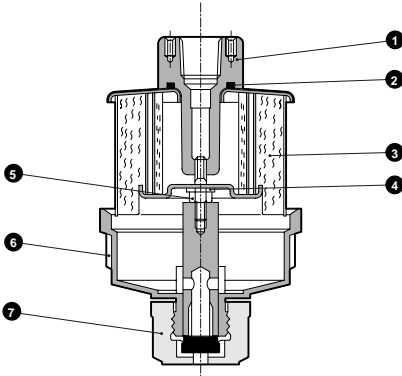

No.	Part name	Material					
		FA331	FA431	FA531	FA631	FA731	FA831
1	Adaptor assembly	Aluminum ally die casting and steel				Aluminum ally casting and steel	
2	O ring	Nitrile rubber					
3	Element assembly	Aluminum alloy, steel and glass fiber					
4	Gasket	Polyacetal resin					
5	Nut	Steel					
6	Case assembly	Polycarbonate resin and aluminum alloy					
7	Drain cock assembly	Nitrile rubber and polyamide resin					

## Dimensions

• FA331 to FA631

• FA731 to FA831

• Bracket (option)

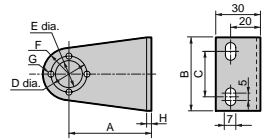
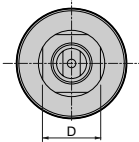
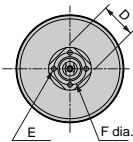

Note) 4 set screws for main body mounting are attached.

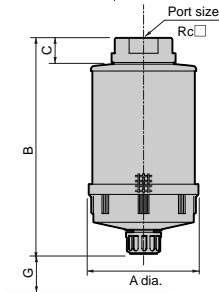
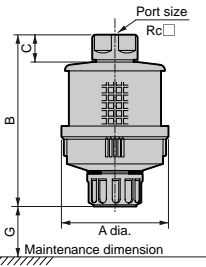

Model no.	A	B	C	D	E	F	G	H
B351-10A	55	50	30	24	18 dia.	R16.5	4-3.5 dia.	2.3t
B451-15A	60	60	40	32	23 dia.	R20	4-4.5 dia.	2.3t
B551-20A	70	70	40	40	29 dia.	R25.4	4-4.5 dia.	3.2t
B651-25A	80	70	40	48	37 dia.	R27.5	4-4.5 dia.	3.2t

### Set piping method

When many valves are used in a place, common piping method is recommended.

- Easy maintenance
- Low cost

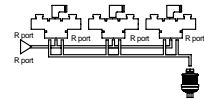

Model no.	FA331	FA431	FA531	FA631	FA731	FA831
A	80	90	100	112	132	150
B	129	147	171	195	259	312
C	20	23	25	28	32	36
D	27	32	41	46	70	80
E	4-M4 (depth 7)	4-M4 (depth 7)	4-M4 (depth 7)	4-M4 (depth 7)	—	—
F	24	32	40	48	—	—
G	80	100	100	100	200	250
Port size	Rc3/8	Rc1/2	Rc3/4	Rc1	Rc1 1/2	Rc2

## ⚠ Precautions

- Oil remaining in the case must be discharged with opening the drain cock before the oil reaching the element.
- To connect a drain tube to the case, follow the following steps.
  - Remove drain cock.
  - Screw half unions with R1/8 male screw into the resin tube to connect.
  - If back pressure raises 0.1MPa and over, replace the element assembly.



Refrigerating type dryer  
Desiccant type dryer  
High polymer membrane dryer  
Air filter  
Automatic drain other  
F.R.L. (Module)  
F.R.L. (Separate)  
Small F.R.  
Precise R.  
Electro pneumatic R.  
Auxiliary  
Flow control valve  
Silencer  
Check valve / others  
Joint / tube  
Vacuum F.  
Vacuum R.  
Vacuum generator  
Vacuum auxiliary / pad  
Mechanical pressure SW  
Electronic pressure SW  
Electronic dif. pres. SW  
Sealing / close contact conf. SW  
Pressure SW for coolant  
Flow sensor for air  
Total air system  
Water cooling refrigerator  
Flow sensor for water

Main line unit  
Exhaust cleaner

## Exhaust cleaner

### Optional parts drawing

---

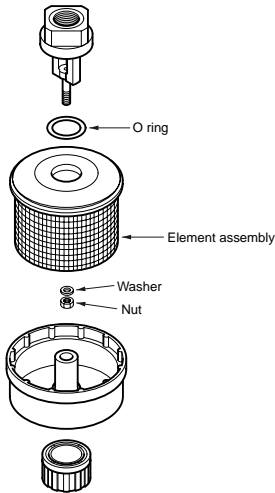

### Element kit

(Set of element assembly, O ring, washer and nut)

Model	Element kit model no.
FA331-10A	FA331-ELEMENT
FA431-15A	FA431-ELEMENT
FA531-20A	FA531-ELEMENT
FA631-25A	FA631-ELEMENT
FA731-40A	FA731-ELEMENT
FA831-50A	FA831-ELEMENT

# Automatic drain / exhaust cleaner / indicator

## Technical data

www.DataSheet4U.com

### Saturated viper rate table

Saturated viper table (relative humidity 100%)

(Unit: g/m<sup>3</sup>)

	Per 1 °C									
	0	1	2	3	4	5	6	7	8	9
90	418	433	449	465	481	498	515	532	551	569
80	291	302	313	325	337	350	363	376	390	404
70	197	205	213	222	231	240	250	259	270	280
60	130	135	141	147	154	160	167	174	182	189
50	82.8	86.7	90.8	95.0	95.5	104	109	114	119	124
40	51.1	53.7	56.4	59.3	62.2	65.3	68.5	71.9	75.4	79.0
30	30.3	32.0	33.7	35.6	37.6	39.6	41.7	43.9	46.2	48.6
20	17.2	18.3	19.4	20.6	21.8	23.0	24.4	25.8	27.2	28.7
10	9.39	10.0	10.7	11.3	12.1	12.8	13.6	14.5	15.4	16.3
0	4.85	5.19	5.56	5.94	6.36	6.79	7.26	7.75	8.27	8.81
-0	4.84	4.84	4.13	3.82	3.52	3.24	2.99	2.75	2.53	2.33
-10	2.14	1.96	1.80	1.65	1.51	1.39	1.27	1.16	1.06	0.967
-20	0.882	0.804	0.732	0.667	0.607	0.551	0.501	0.454	0.412	0.373
-30	0.338	0.305	0.276	0.249	0.225	0.203	0.183	0.164	0.148	0.133
-40	0.119	0.107	0.0955	0.0854	0.0763	0.0681	0.0608	0.0541	0.0482	0.0428
-50	0.0381	0.0338	0.0299	0.0265	0.0234	0.0207	0.0183	0.0161	0.0142	0.0125
-60	0.0109	0.00959	0.00840	0.00734	0.00642	0.00560	0.00488	0.00425	0.00369	0.00320
-70	0.00277	0.00240	0.00207	0.00179	0.00154	0.00133	0.00114	0.000977	0.000836	0.000715
-80	0.000610	0.000520	0.000442	0.000376	0.000318	0.000269	0.000228	0.000192	0.000162	0.000136
-90	0.000114	0.0000952	0.0000795	0.0000663	0.0000551	0.0000458	0.0000379	0.0000313	0.0000259	0.0000213

How to read saturated viper rate table  
In the table, temperature per 1°C is indicated in columns, while temperature per 10°C in rows.

(E.g.) Find saturated viper rate for 32°C.

E.g. 32 °C	Per 1 °C									
	0	1	2	3	4	5	6	7	8	9
Per 10 °C	40									
	30			33.7						
	20									

33.7g/m<sup>3</sup> is obtained according to the table above.

### Pressure dew point - atmospheric dew point conversion table

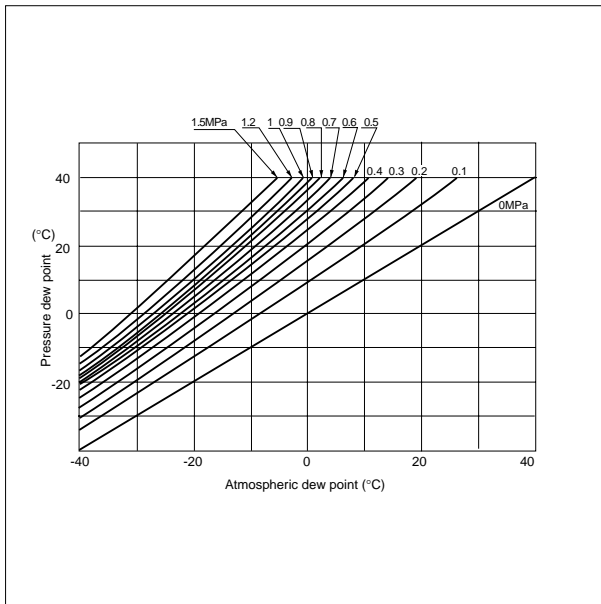

How to read pressure dew point

- atmospheric dew point conversion table

Use this table to convert pressure dew point per pressure to atmospheric dew point or atmospheric dew point to pressure dew point.

(E.g.) Where pressure 0.7MPa and pressure dew point 5°C, find atmospheric dew point.

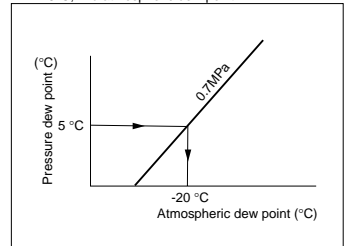

If pressure dew point 5°C is converted to atmospheric dew point at pressure 0.7MPa, -20°C is obtained.

www.DataSheet4U.com