



FAN23SV04T

4 A Synchronous Buck Regulator for DDR Termination

Features

- V_{IN} Range: 7 V to 18 V Using Internal Linear Regulator for Bias
- V_{IN} Range: 4.5 V to 5.5 V with $V_{IN}/P_{VIN}/P_{VCC}$ Connected to Bypass Internal Regulator
- High Efficiency
- Continuous Output Current: 4 A
- Internal Linear Bias Regulator
- Internal V_{DDQ} Resistor Divider
- Excellent Line and Load Transient Response
- Output Voltage Range: 0.5 to 1.5 V
- Programmable Frequency: 200 kHz to 1.5 MHz
- Programmable Soft-Start
- Low Shutdown Current
- Adjustable Sourcing Current Limit
- Internal Boot Diode
- Thermal Shutdown
- Halogen and Lead Free, RoHS Compliant

Applications

- Bus Termination
- Servers and Desktop Computers
- NVDC Notebooks, Netbooks
- Game Consoles

Description

The FAN23SV04T is a highly efficient, synchronous buck regulator for use in tracking applications, such as DDR termination rails. The V_{DDQ} input includes an internal 2:1 resistive voltage divider to reduce total circuit size and component count. The regulator operates with an input range from 7 V to 18 V and supports up to 4 A load currents. The device can operate from a 5 V rail ($\pm 10\%$) if V_{IN} , P_{VIN} , and P_{VCC} are connected together to bypass the internal linear regulator.

This device utilizes Fairchild's constant on-time control architecture to provide excellent transient response and to maintain a relatively constant switching frequency.

Switching frequency and sourcing over-current protection can be programmed to provide a flexible solution for various applications.

Output over-current, and thermal shutdown protections help prevent damage during fault conditions. A hysteresis feature restarts the device when normal operating temperature is reached.

Ordering Information

Part Number	Configuration	Operating Temperature Range	Output Current	Package
FAN23SV04TMPX	PWM Mode with V_{DDQ} Tracking Input	-40 to 125°C	4 A	34-Lead, PQFN, 5.5 mm x 5.0 mm

Typical Application Diagrams

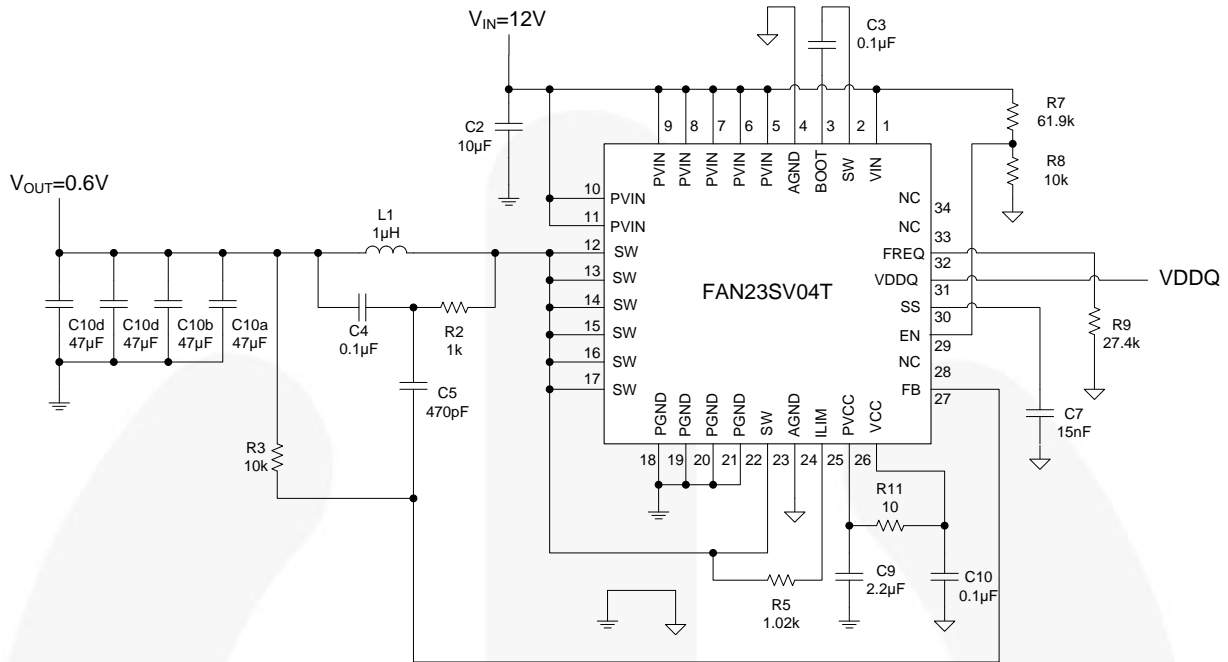

Figure 1. Typical Application with $V_{IN} = 12\text{ V}$

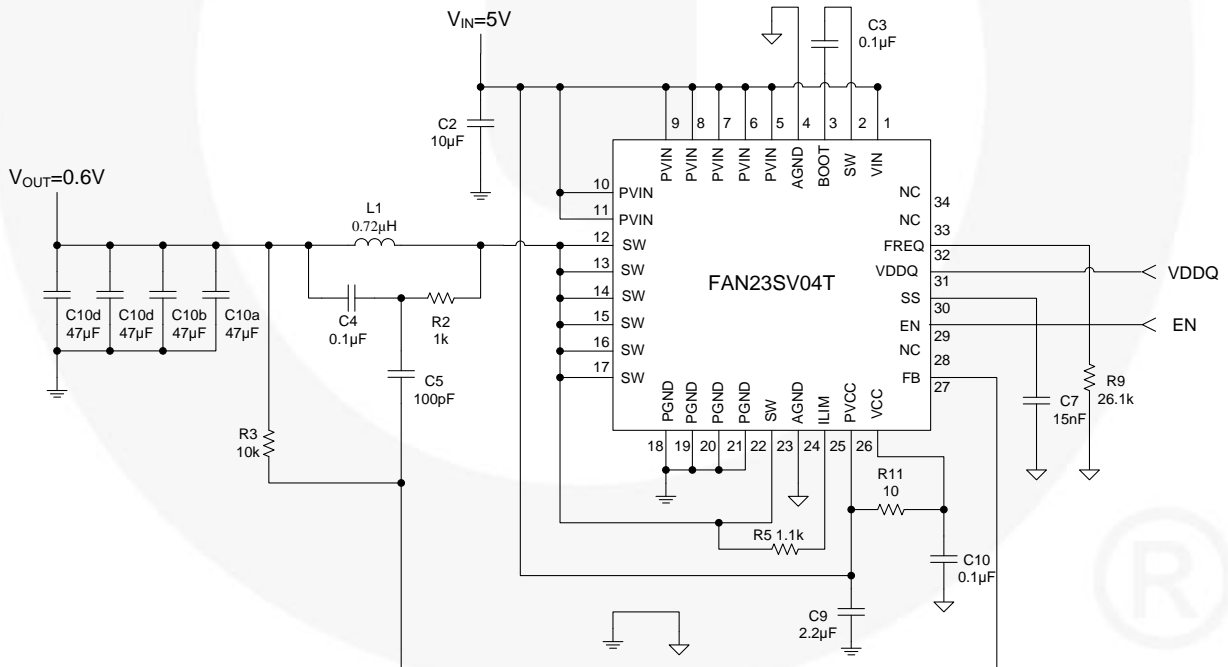

Figure 2. Typical Application with $V_{IN} = 5\text{ V}$

Functional Block Diagram

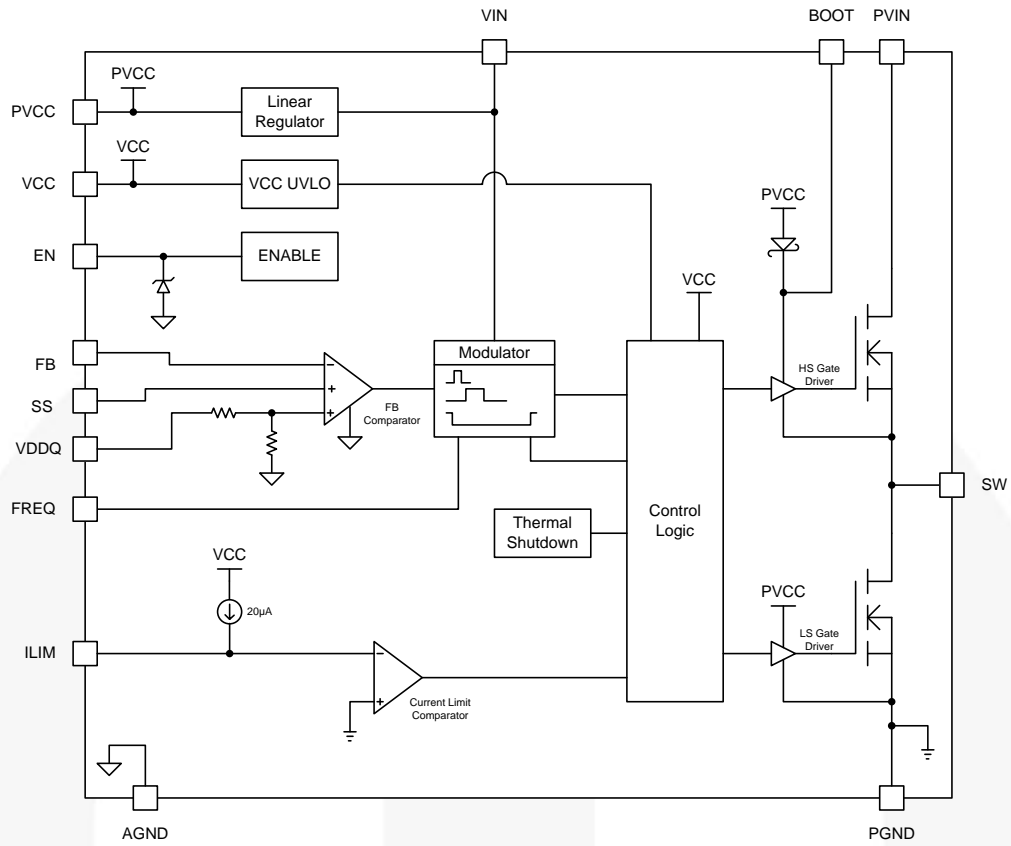

Figure 3. Block Diagram

Pin Configuration

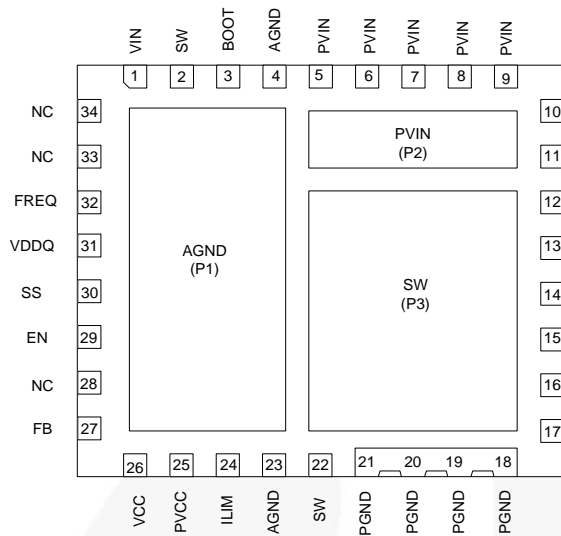

Figure 4. Bottom View

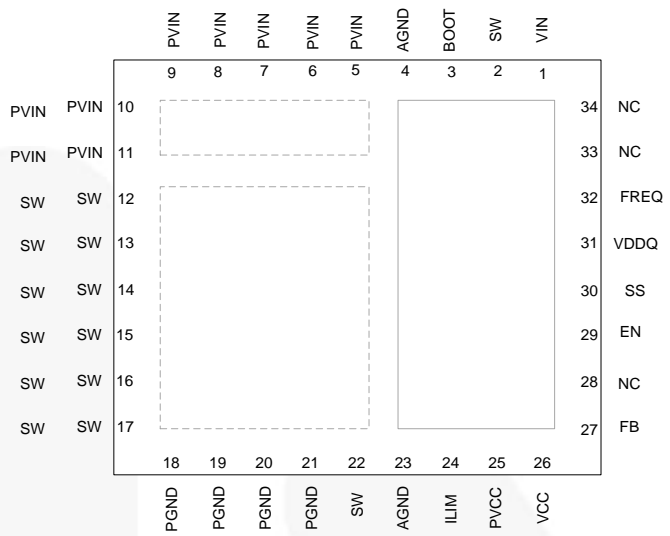

Figure 5. Top View

Pin Definitions

Name	Pad / Pin	Description
PVIN	P2; 5-11	Power input for the power stage.
VIN	1	Power input to the linear regulator; used in the modulator for input voltage feed-forward.
PVCC	25	Power output of the linear regulator; directly supplies power for the low-side gate driver and boot diode. Can be connected to VIN and PVIN for operation from 5 V rail.
VCC	26	Power supply input for the controller.
PGND	18-21	Power ground for the low-side power MOSFET and for the low-side gate driver.
AGND	P1; 4, 23	Analog ground for the analog portions of the IC and for substrate.
SW	P3; 2, 12-17, 22	Switching node; junction between high-and low-side MOSFETs.
BOOT	3	Supply for high-side MOSFET gate driver. A capacitor from BOOT to SW supplies the charge to turn on the N-channel high-side MOSFET. During the freewheeling interval (low-side MOSFET on), the high-side capacitor is recharged by an internal diode connected to PVCC.
ILIM	24	Current limit. A resistor between ILIM and SW sets the current-limit threshold.
FB	27	Output voltage feedback to the modulator.
EN	29	Enable input to the IC. Pin must be driven logic high to enable, or logic low to disable.
SS	30	Soft-Start input to the modulator
VDDQ	31	External reference input to the modulator. The modulator regulates to half of the voltage at the VDDQ pin.
FREQ	32	On-time and frequency programming pin. Connect a resistor between FREQ and AGND to program on-time and switching frequency.
NC	28, 33-34	Leave pin open or connect to AGND.

Absolute Maximum Ratings

Stresses exceeding the absolute maximum ratings may damage the device. The device may not function or be operable above the recommended operating conditions and stressing the parts to these levels is not recommended. In addition, extended exposure to stresses above the recommended operating conditions may affect device reliability. The absolute maximum ratings are stress ratings only.

Symbol	Parameter	Condition	Min.	Max.	Unit
V _{PVIN}	Power Input	Referenced to PGND	-0.3	25.0	V
V _{IN}	Modulator Input	Referenced to AGND	-0.3	25.0	V
V _{BOOT}	Boot Voltage	Referenced to PVCC	-0.3	26.0	V
		Referenced to PVCC, <20 ns	-0.3	30.0	V
V _{SW}	SW Voltage to GND	Referenced to PGND, AGND	-1	25	V
		Referenced to PGND, AGND < 20 ns	-5	25	V
V _{BOOT}	Boot to SW Voltage	Referenced to SW	-0.3	6.0	V
	Boot to PGND	Referenced to PGND	-0.3	30	V
V _{PVCC}	Gate Drive Supply Input	Referenced to PGND, AGND	-0.3	6.0	V
V _{VCC}	Controller Supply Input	Referenced to PGND, AGND	-0.3	6.0	V
V _{ILIM}	Current Limit Input	Referenced to AGND	-0.3	6.0	V
V _{FB}	Output Voltage Feedback	Referenced to AGND	-0.3	6.0	V
V _{EN}	Enable Input	Referenced to AGND	-0.3	6.0	V
V _{SS}	Soft Start Input	Referenced to AGND	-0.3	6.0	V
V _{FREQ}	Frequency Input	Referenced to AGND	-0.3	6.0	V
V _{DDQ}	VDDQ Input	Referenced to AGND	-0.3	6.0	V
ESD	Electrostatic Discharge	Human Body Model, JESD22-A114 ⁽¹⁾		2000	V
		Charged Device Model, JESD22-C101 ⁽²⁾		2500	V
T _J	Junction Temperature			+150	°C
T _{STG}	Storage Temperature		-55	+150	°C

Note:

- Exception for FB pin up to 350V
- Exception for FB pin up to 500V

Recommended Operating Conditions

The Recommended Operating Conditions table defines the conditions for actual device operation. Recommended operating conditions are specified to ensure optimal performance to the datasheet specifications. Fairchild does not recommend exceeding them or designing to Absolute Maximum Ratings.

Symbol	Parameter	Condition	Min.	Max.	Unit
V _{PVIN}	Power Input	Referenced to PGND	7	18	V
V _{IN}	Modulator Input	Referenced to AGND	7	18	V
T _J	Junction Temperature		-40	+125	°C
I _{LOAD}	Load Current	T _A =25°C, No Airflow		6	A
V _{PVIN} , V _{IN} , V _{PVCC}	PV _{IN} , V _{IN} , and Gate Drive Supply Input	V _{PVIN} , V _{IN} , V _{PVCC} Connected for 5 V Rail Operation and Referenced to PGND, AGND	4.5	5.5	V

Thermal Characteristics

The thermal characteristics were evaluated on a 4-layer pcb structure (1 oz/1 oz/1 oz/1 oz) measuring 7 cm x 7 cm).

Symbol	Parameter	Typ.	Unit
Θ_{JA}	Thermal Resistance, Junction-to-Ambient	35	°C/W
ψ_{JC}	Thermal Characterization Parameter, Junction-to-Top of Case	2.7	°C/W
ψ_{JPCB}	Thermal Characterization Parameter, Junction-to-PCB	2.3	°C/W

Electrical CharacteristicsUnless otherwise noted; $V_{IN}=12\text{ V}$, $V_{OUT}=0.6\text{ V}$, $T_A=T_J=-40\text{ to }+125^\circ\text{C}$.⁽⁴⁾

Symbol	Parameter	Condition	Min.	Typ.	Max.	Unit
Supply Current						
$I_{VIN,SD}$	Shutdown Current	$E_N=0\text{ V}$			16	μA
$I_{VIN,Q}$	Quiescent Current	$E_N=5\text{ V}$, Not Switching			1.8	mA
$I_{VIN,GateCharge}$	Gate Charge Current	$E_N=5\text{ V}$, $f_{SW}=500\text{ kHz}$		10		mA
Linear Regulator						
V_{REG}	Regulator Output Voltage		4.75	5.00	5.25	V
I_{REG}	Regulator Current Limit		60			mA
Reference, Feedback Comparator						
V_{FB}	FB Voltage Threshold		590	596	602	mV
V_{DDQ}	V_{DDQ} Pin Voltage Range		0		3	V
I_{FB}	FB Pin Bias Current		-100	0	100	nA
Modulator						
t_{ON}	On-Time Accuracy	$R_{FREQ}=56\text{ k}$, $V_{IN}=10\text{ V}$, $t_{ON}=250\text{ ns}$, No Load	-20		20	%
$t_{OFF,MIN}$	Minimum SW Off-Time			320	374	ns
D_{MIN}	Minimum Duty Cycle	$FB=1\text{ V}$		0		%
Soft-Start						
I_{SS}	Soft-Start Current	$SS=0\text{ V}$	7	10	13	μA
Current Limit						
I_{LIM}	Valley Current Limit Accuracy	$T_A=T_J=25^\circ\text{C}$, $I_{VALLEY}=4\text{ A}$	-10		10	%
K_{LIM}	I_{LIM} Set-Point Scale Factor			233		
I_{LIMTC}	Temperature Coefficient			4000		$\text{ppm}/^\circ\text{C}$
Enable						
V_{TH+}	Rising Threshold		1.11	1.26	1.43	V
V_{HYST}	Hysteresis			122		mV
V_{TH-}	Falling Threshold		1.00	1.14	1.28	V
$V_{ENCLAMP}$	Enable Voltage Clamp	$I_{EN}=20\text{ }\mu\text{A}$	4.3	4.5		V
$I_{ENCLAMP}$	Clamp Current	$E_N=5\text{ V}$	24			μA
I_{ENLK}	Enable Pin Leakage	$E_N=1.2\text{ V}$			100	nA
I_{ENLK}	Enable Pin Leakage	$V_{EN}=5\text{ V}$			76	μA
UVLO						
V_{ON}	V_{CC} Good Threshold Rising				4.4	V
V_{HYS}	Hysteresis Voltage			160		mV
Thermal Shutdown						
T_{OFF}	Thermal Shutdown Trip Point ⁽³⁾			155		$^\circ\text{C}$
T_{HYS}	Hysteresis ⁽³⁾			15		$^\circ\text{C}$
Internal Bootstrap Diode						
V_{FBOOT}	Forward Voltage	$I_F=10\text{ mA}$			0.6	V
I_R	Reverse Leakage	$V_R=5\text{ V}$			1000	μA

Notes:

- Guaranteed by design; not production tested.
- Device is 100% production tested at $T_A=25^\circ\text{C}$. Limits over that temperature are guaranteed by design.

Typical Performance Characteristics

Tested using evaluation board circuit shown in Figure 1 with $V_{IN}=12\text{ V}$, $V_{OUT}=0.6\text{ V}$, $f_{SW}=500\text{ kHz}$, $T_A=25^\circ\text{C}$, and no airflow; unless otherwise specified.

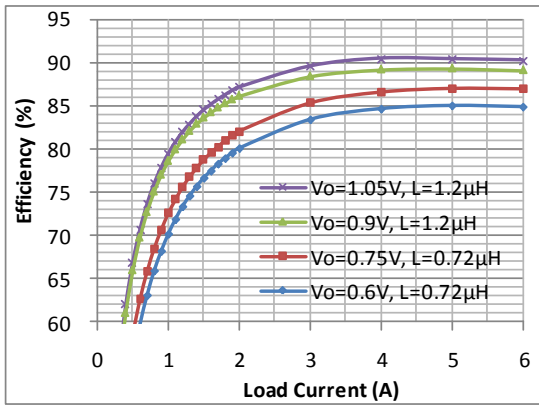

Figure 6. Efficiency vs. Load Current $V_{IN}=12\text{ V}$ and $f_{SW}=500\text{ kHz}$

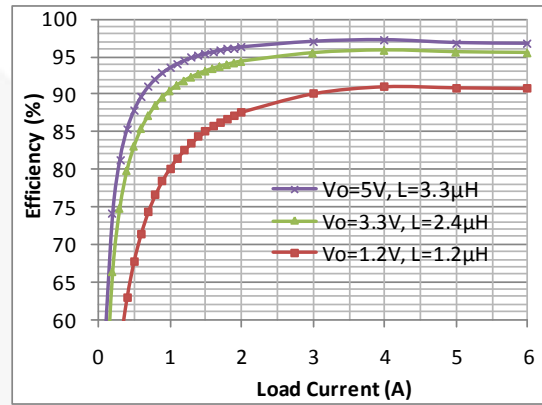

Figure 7. Efficiency vs. Load Current $V_{IN}=12\text{ V}$ and $f_{SW}=500\text{ kHz}$

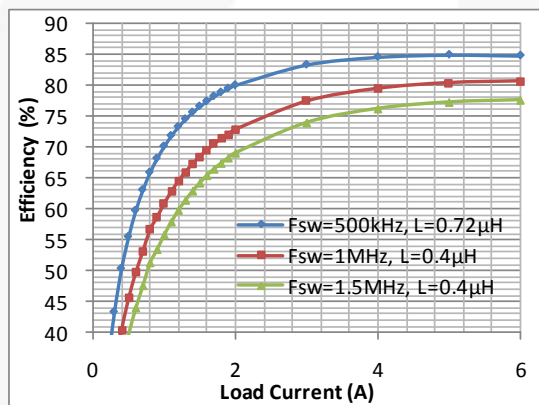

Figure 8. Efficiency vs. Load Current with $V_{IN}=12\text{ V}$ and $V_{OUT}=0.6\text{ V}$

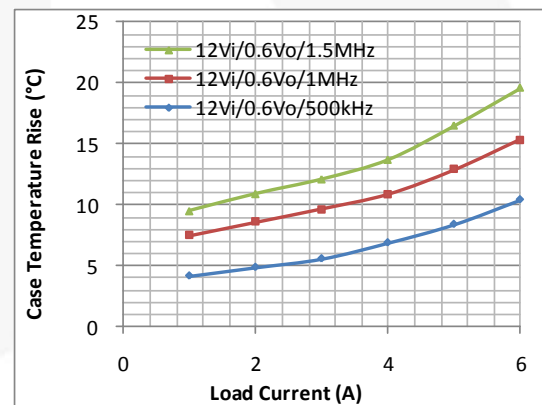

Figure 9. Case Temperature Rise vs. Load Current

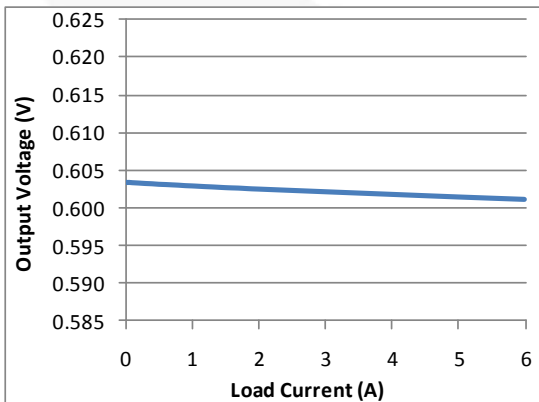

Figure 10. Load Regulation

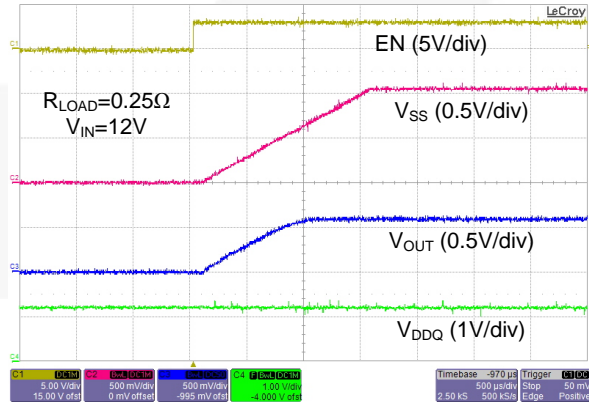

Figure 11. Startup Waveforms Using Soft-Start with 2.4 A Resistive Load

Typical Performance Characteristics (Continued)

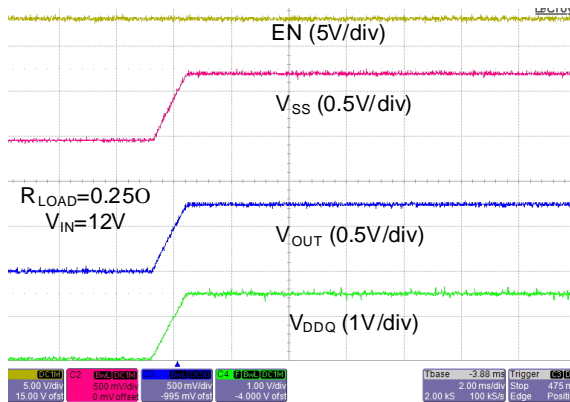

Figure 12. Startup Waveforms Tracking V_{DDQ} with 2.4 A Resistive Load

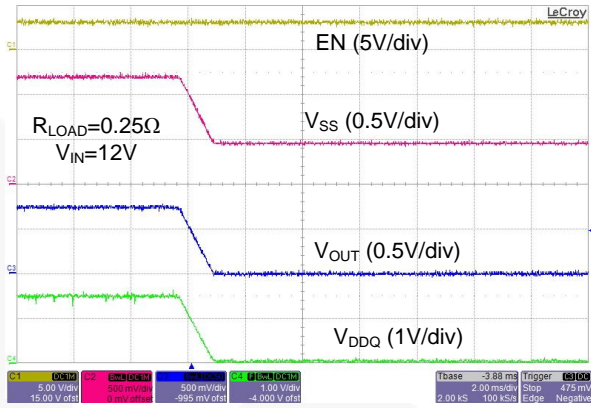

Figure 13. Shutdown Waveforms Tracking V_{DDQ} with 2.4 A Resistive Load

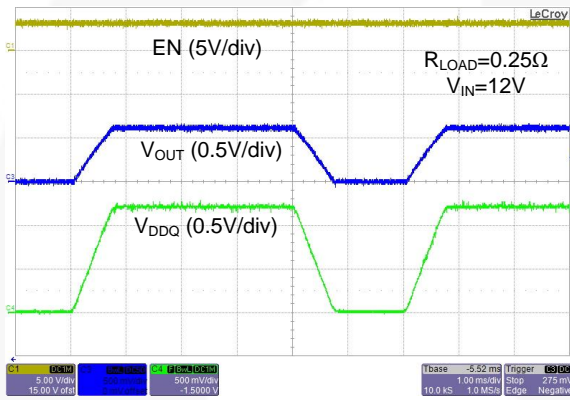

Figure 14. Tracking Operation with Variable V_{DDQ} Reference Input

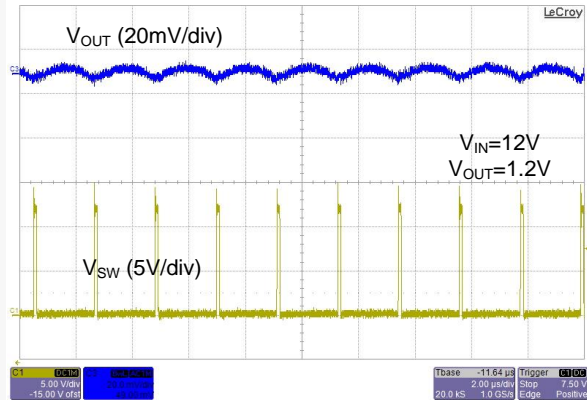

Figure 15. Static Output Ripple with No Load

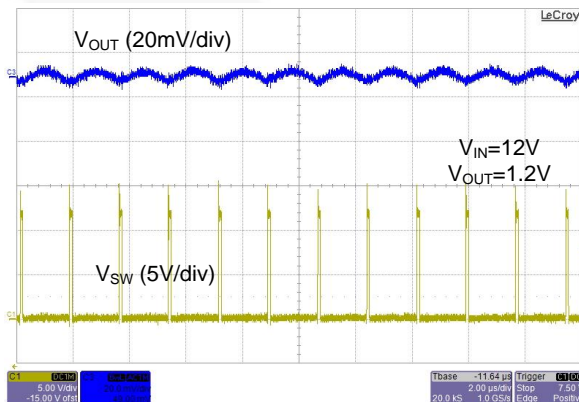

Figure 16. Static Output Ripple with 4 A Load Current

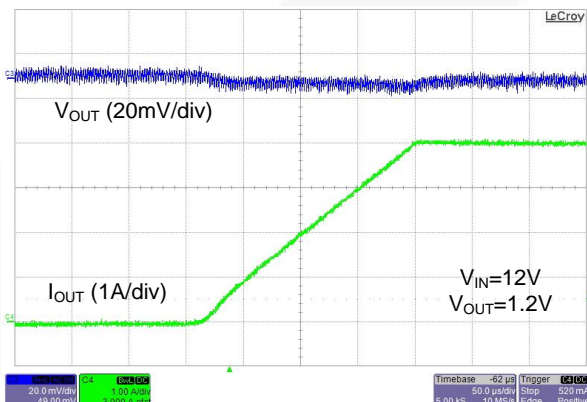

Figure 17. Operation as Load Changes from 0 A to 4 A

Typical Performance Characteristics (Continued)

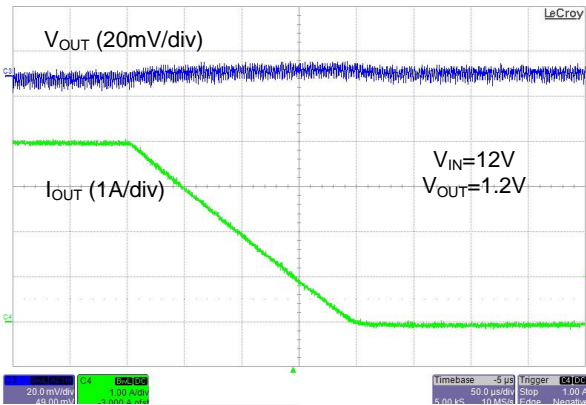

Figure 18. Operation as Load Changes from 4 A to 0 A

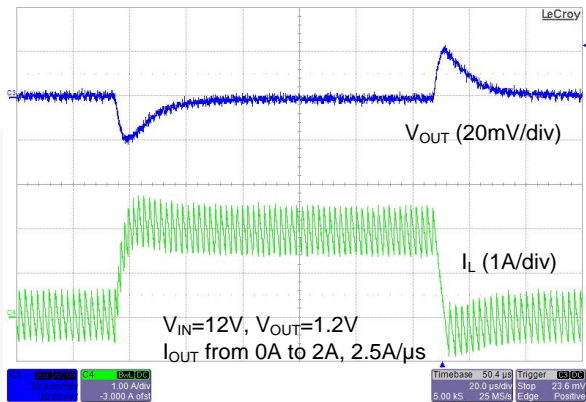

Figure 19. Load Transient from 0% to 50% Load Current

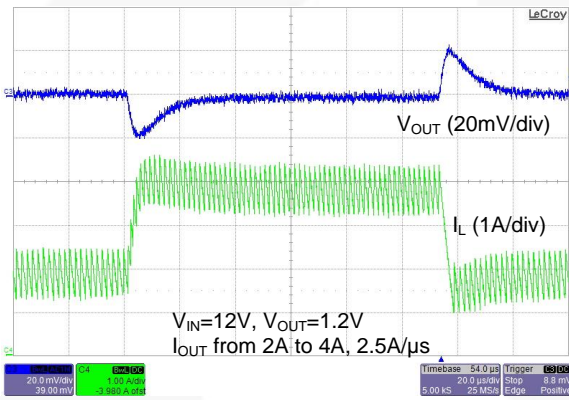

Figure 20. Load Transient from 50% to 100% Load Current

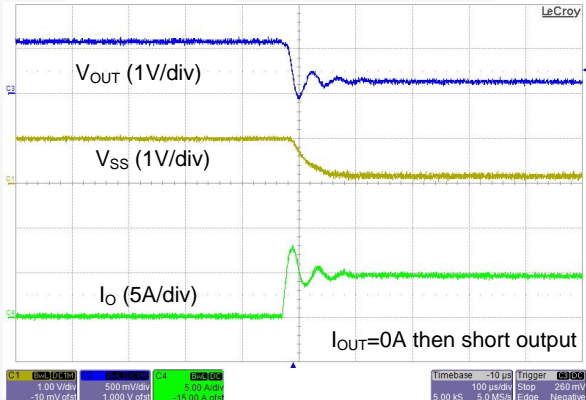

Figure 21. Over-Current Protection with Heavy Load

Circuit Operation

The FAN23SV04T uses a constant-on-time modulation architecture with a V_{IN} feed-forward input to accommodate a wide V_{IN} range. This method provides fixed switching frequency (f_{SW}) operation when the inductor operates in Continuous Conduction Mode (CCM). Additional benefits include excellent line and load transient response, cycle-by-cycle current limiting, and elimination of loop compensation requirements.

At the beginning of each cycle, FAN23SV04T turns on the high-side MOSFET (HS) for a fixed duration (t_{ON}). At the end of t_{ON} , HS turns off for a duration (t_{OFF}) determined by the operating conditions. Once the FB voltage (V_{FB}) falls below the reference voltage (V_{REF}), a new switching cycle begins.

The modulator provides a minimum off-time ($t_{OFF-MIN}$) of 250 ns to provide a guaranteed interval for low-side MOSFET (LS) current sensing and PFM operation. $t_{OFF-MIN}$ provides stability against multiple pulsing and limits maximum switching frequency during transient events.

Enable

The enable pin can be driven with an external logic signal, connected to a resistive divider from PV_{IN}/V_{in} to ground to create an Under-Voltage Lockout (UVLO) based on the PV_{IN}/V_{IN} supply, or connected to PV_{IN}/V_{IN} through a single resistor to auto-enable while operating within the EN pin internal clamp current sink capability.

The EN pin can be directly driven by logic voltages of 5 V, 3.3 V, 2.5 V, etc. If the EN pin is driven by 5 V logic, a small current flows into the pin when the EN pin voltage exceeds the internal clamp voltage of 4.3 V. To eliminate clamp current flowing into the EN pin use a voltage divider to limit the EN pin voltage to < 4 V.

To implement the UVLO function based on PV_{IN}/V_{IN} voltage level, select values for R7 and R8 in Figure 1 such that the tap point reaches 1.26 V when V_{IN} reaches the desired startup level using the following equation:

$$R7 = R8 \left(\frac{V_{IN,on}}{V_{EN,on}} - 1 \right) \quad (1)$$

where $V_{IN,on}$ is the input voltage for startup and $V_{EN,on}$ is the EN pin rising threshold of 1.26 V. With R8 selected as 10 k Ω , and $V_{IN,on}=9$ V the value of R7 is 61.9 k Ω .

The EN pin can be pulled high with a single resistor connected from V_{IN} to the EN pin. With $V_{IN} > 5.5$ V a series resistor is required to limit the current flow into the EN pin clamp to less than 24 μ A to keep the internal clamp within normal operating range. The resistor value can be calculated from the following equation:

$$R_{EN} > \frac{V_{IN,max} - V_{EN,clamp,min}}{22\mu A} \quad (2)$$

Constant On-Time Modulation

The FAN23SV04T uses a constant on-time modulation technique, in which the HS MOSFET is turned on for a fixed time, set by the modulator, in response to the input

voltage and the frequency-setting resistor. This on-time is proportional to the desired output voltage, divided by the input voltage. With this proportionality, the frequency is essentially constant over the load range where inductor current is continuous.

For a buck converter in Continuous-Conduction Mode (CCM), the switching frequency f_{SW} is expressed as:

$$f_{SW} = \frac{V_{OUT}}{V_{IN} \cdot t_{ON}} \quad (3)$$

The on-time generator sets the on-time (t_{ON}) for the high-side MOSFET, which results in the switching frequency of the regulator during steady-state operation. To maintain a relatively constant switching frequency over a wide range of input conditions, the input voltage information is fed into the on-time generator.

t_{ON} is determined by:

$$t_{ON} = \frac{C_{LON}}{I_{LON}} \cdot 2V \quad (4)$$

where I_{LON} is:

$$I_{LON} = \frac{1}{10} \cdot \frac{V_{IN}}{R_{FREQ}} \quad (5)$$

where R_{FREQ} is the frequency-setting resistor described in the Setting Switching Frequency section; C_{LON} is the internal 2.2 pF capacitor; and I_{LON} is the V_{IN} feed-forward current that generates the on-time.

The FAN23SV04T implements open-circuit detection on the FREQ pin to protect the output from an infinitely long on-time. In the event the FREQ pin is left floating, switching of the regulator is disabled. The FAN23SV04T is designed for a V_{IN} input range 7 to 18 V and f_{SW} from 200 kHz to 1.5 MHz, resulting in an I_{LON} ratio of 1 to 16.

As the ratio of V_{OUT} to V_{IN} increases, $t_{OFF,min}$ introduces a limit on the maximum switching frequency as calculated in the following equation, where the factor 1.2 is included in the denominator to provide some headroom for transient operation:

$$f_{SW} < \frac{\left(1 - \frac{V_{OUT}}{V_{IN,min}}\right)}{1.2 \cdot t_{OFF,min}} \quad (6)$$

VDDQ

This pin is connected to the V_{DDQ} supply, which the FAN23SV04T must track during startup and produce an output (V_{TT}) equal to half of V_{DDQ} in steady-state conditions. To accomplish this, the V_{DDQ} pin has an internal resistor divider to AGND that provides a reference voltage equal to $V_{DDQ}/2$ at the positive input of the FB comparator.

Soft-Start (SS)

A conventional soft-start ramp is implemented to provide a controlled startup sequence of the output voltage. A current is generated on the SS pin to charge an external capacitor. The lesser of the voltage on the SS pin and the reference voltage is used for output regulation.

During normal operation, the SS voltage is clamped to 400 mV above the FB voltage. The clamp voltage drops to 40 mV during an overload condition (when V_{FB} is \leq 400 mV) to allow the converter to recover using the soft-start ramp once the overload condition is removed. There is no on-time modulation during normal soft-start or when recovering from an overload condition.

The nominal startup time is programmable through an internal current source charging the external soft-start capacitor C_{SS} :

$$C_{SS} = \frac{I_{SS} \cdot t_{SS}}{V_{REF}} \quad (7)$$

where:

C_{SS} = External soft-start programming capacitor;

I_{SS} = Internal soft-start charging current source, 10 μ A;

t_{SS} = Soft-start time; and

V_{REF} = VDDQ/2.

For example; for 1 ms startup time, C_{SS} =15 nF.

The soft-start option can be used for ratiometric tracking.

When EN is LOW, the soft-start capacitor is discharged.

Internal Linear Regulator

The FAN23SV04T includes a linear regulator to facilitate single-supply operation for self-biased applications. PVCC is the linear regulator output and supplies power to the internal gate drivers. The PVCC pin should be bypassed with a 2.2 μ F ceramic capacitor. The device can operate from a 5 V rail if the V_{IN} , P_{VIN} , and P_{VCC} pins are connected together to bypass the internal linear regulator.

V_{CC} Bias Supply and UVLO

The V_{CC} rail supplies power to the controller. It is generally connected to the PVCC rail through a low-pass filter of a 10 Ω resistor and 0.1 μ F capacitor to minimize any noise sources from the driver supply.

An Under-Voltage Lockout (UVLO) circuit monitors the V_{CC} voltage to ensure proper operation. Once the V_{CC} voltage is above the UVLO threshold, the part begins operation after an initialization routine of 50 μ s. There is no UVLO circuitry on either the PVCC or V_{IN} rails.

Over-Current Protection (OCP)

The FAN23SV04T uses current information through the LS to implement valley-current limiting. While an OC event is detected, the HS is prevented from turning on and the LS is kept on until the current falls below the user-defined set point. Once the current is below the set point, the HS is allowed to turn on.

The ILIM pin has an open detection circuit to provide protection against operation without a current limit.

Over-Temperature Protection (OTP)

FAN23SV04T incorporates an over-temperature protection circuit that disables the converter when the die temperature reaches 155°C. The IC restarts when the die temperature falls below 140°C.

Application Information

Stability

Constant on-time stability consists of two parameters: stability criterion and sufficient signal at V_{FB} .

Stability criterion is given by:

$$R_{ESR} \cdot C_{OUT} \gg \frac{t_{ON}}{2} \quad (8)$$

Sufficient signal requirement is given by:

$$\Delta I_{IND} \cdot R_{ESR} > \Delta V_{FB} \quad (9)$$

where ΔI_{IND} is the inductor current ripple and ΔV_{FB} is the ripple voltage on V_{FB} , which should be \geq 12 mV.

In certain applications, especially designs utilizing only ceramic output capacitors, there may not be sufficient ripple magnitude available on the feedback pin for stable operation. In this case, an external circuit, such as R2-C4-C5 shown in Figure 1, can be added to inject ripple voltage into the FB pin.

There are some specific considerations when selecting the RCC ripple injector circuit. For typical applications, the value of C4 can be selected as 0.1 μ F and approximate values for R2 and C5 can be determined using the following equations.

R2 must be small enough to develop 12 mV of ripple:

$$R2 < \frac{(V_{IN} - V_{OUT}) \cdot V_{OUT}}{V_{IN} \cdot 0.012V \cdot C4 \cdot f_{SW}} \quad (10)$$

R2 must also be selected such that the R2C4 time constant enables stable operation:

$$R2 < \frac{0.33 \cdot 2\pi \cdot f_{SW} \cdot L_{OUT} \cdot C_{OUT}}{C4} \quad (11)$$

The minimum value of C5 can be selected to minimize the capacitive component of ripple appearing on the feedback pin:

$$C5_{MIN} = \frac{L_{OUT} \cdot C_{OUT}}{R2 \cdot R3 \cdot C4} \quad (12)$$

Using the minimum value of C5 generally offers the best transient response, and 100 pF is a good initial value in many applications. However, under some operating conditions excessive pulse jitter may be observed. To reduce jitter and improve stability, the value of C5 can be increased:

$$C5 \geq 2 \cdot C5_{MIN} \quad (13)$$

5 V PV_{CC}

The PV_{CC} is the output of the internal regulator that supplies power to the drivers and V_{CC} . It is crucial to keep this pin decoupled to PGND with a \geq 1 μ F X5R or X7R ceramic capacitor. Because V_{CC} powers the internal analog circuit, it is filtered from PV_{CC} with a 10 Ω resistor and 0.1 μ F X7R decoupling ceramic capacitor to AGND.

Setting the Output Voltage (V_{OUT})

The output voltage, V_{OUT} , is regulated by initiating a high-side MOSFET on-time interval when the valley of the divided output voltage appearing at the FB pin reaches V_{REF} . Since this method regulates at the valley of the output ripple voltage, the actual DC output voltage on V_{OUT} is offset from the programmed output voltage by the average value of the output ripple voltage. The output V_{OUT} setting of the regulator can be determined using the following equation:

$$V_{OUT} = \frac{V_{DDQ}}{2} \quad (14)$$

where V_{DDQ} is the voltage applied to pin 31.

For example; if $V_{DDQ}=1.2\text{ V}$ then $V_{OUT}=600\text{ mV}$. V_{FB} is trimmed to a value of 596 mV when $V_{DDQ}=V_{REF}=600\text{ mV}$. The final output voltage, including the effect of the output ripple voltage, can be approximated by:

$$V_{OUT} = V_{FB} * \left[\frac{V_{rip}}{2} \right] \quad (15)$$

Setting the Switching Frequency (f_{sw})

f_{sw} is programmed through external R_{FREQ} as follows:

$$R_{FREQ} = \frac{V_{OUT}}{20 * C_{TON} * f_{sw}} \quad (16)$$

where $C_{TON}=2.2\text{ pF}$. For example; for $f_{sw}=500\text{ kHz}$ and $V_{OUT}=0.6\text{ V}$, then select a standard resistor value for $R_{FREQ}=27.4\text{ k}\Omega$.

Inductor Selection

The inductor is typically selected based on the ripple current (ΔI_L), which is approximately 25% to 45% of the maximum DC load. The inductor current rating should be selected such that the saturation and heating current ratings exceed the intended currents encountered in the application over the expected temperature range of operation. Regulators that require fast transient response use smaller inductance and higher current ripple; while regulators that require higher efficiency keep ripple current on the low side.

The inductor value is given by:

$$L = \frac{(V_{IN} - V_{OUT}) \cdot V_{OUT}}{\Delta I_L \cdot f_{sw}} \quad (17)$$

For example: for 12 V V_{IN} , 0.6 V V_{OUT} , 4 A load, 25% I_L , and 500 kHz f_{sw} ; L is calculated to be 1.1 μH and a standard value of 1 μH is selected.

Input Capacitor Selection

Input capacitor C_{IN} is selected based on voltage rating, RMS current $I_{CIN(RMS)}$ rating, and capacitance. For capacitors with DC voltage bias derating, such as ceramic capacitors, higher rating is strongly recommended. RMS current rating is given by:

$$I_{CIN(RMS)} = I_{LOAD-MAX} \cdot \sqrt{D \cdot (1 - D)} \quad (18)$$

where $I_{LOAD-MAX}$ is the maximum load current and D is the duty cycle V_{OUT}/V_{IN} . The maximum $I_{CIN(RMS)}$ occurs at 50% duty cycle.

The capacitance is given by:

$$C_{IN} = \frac{I_{LOAD-MAX} \cdot D \cdot (1 - D)}{f_{sw} \cdot \Delta V_{IN}} \quad (19)$$

where ΔV_{IN} is input voltage ripple, normally 1% of V_{IN} .

For example: for $V_{IN}=12\text{ V}$, $\Delta V_{IN}=120\text{ mV}$, $V_{OUT}=0.6\text{ V}$, 4 A load, and $f_{sw}=950\text{ kHz}$; then C_{IN} is calculated as 1.7 μF , select a single 10 μF , 25 V-rated ceramic capacitor with X7R or similar dielectric, recognizing that the capacitor DC bias characteristic indicates that the capacitance value falls approximately 40% at $V_{IN}=12\text{ V}$.

Output Capacitor Selection

Output capacitor C_{OUT} is also selected based on voltage rating, RMS current I_{CIN} (RMS) rating, and capacitance. For capacitors with DC voltage bias derating, such as ceramic capacitors, higher rating is recommended.

When calculating C_{OUT} , usually the dominant requirement is the current load step transient. If the unloading transient requirement (I_{OUT} transitioning from HIGH to LOW), is satisfied, the load transient (I_{OUT} transitioning LOW to HIGH), is also usually satisfied. The unloading C_{OUT} calculation, assuming C_{OUT} has negligible parasitic resistance and inductance in the circuit path, is given by:

$$C_{OUT} = L \cdot \frac{I_{LEVEL1}^2 - I_{LEVEL2}^2}{(V_{OUT} + \Delta V_{OUT})^2 - V_{OUT}^2} \quad (20)$$

where I_{level1} and I_{level2} are current levels before and after load steps, and ΔV_{OUT} is the voltage overshoot, usually specified at 3 to 5%.

For example: for $V_{IN}=12\text{ V}$, $V_{OUT}=0.6\text{ V}$, $I_{LEVEL1}=3\text{ A}$, $I_{LEVEL2}=2\text{ A}$, $f_{sw}=500\text{ kHz}$, $L_{OUT}=1\text{ }\mu\text{H}$, and 4.0% ΔV_{OUT} overshoot of 24 mV; the C_{OUT} value is calculated to be 170 μF , and four 47 μF , 6.3 V-rated X5R ceramic capacitors may be used. This equation assumes that the load current rises instantaneously; with reduced current slew rate, the value for C_{OUT} can be reduced.

Setting the Current Limit

Current limit is implemented by sensing the inductor valley current across the LS MOSFET V_{DS} during the LS on-time. The current-limit comparator prevents a new on-time from starting until the valley current is less than the current limit.

The set point is configured by connecting a resistor from the ILIM pin to the SW pin. A trimmed current is output onto the ILIM pin, which creates a voltage across the resistor. When the voltage on ILIM goes negative, an over-current condition is detected.

R_{ILIM} is calculated by:

$$R_{ILIM} = 1.02 * K_{ILIM} * I_{VALLEY} \quad (21)$$

where K_{ILIM} is the current source scale factor, and I_{VALLEY} is the inductor valley current when the current limit threshold is reached. The factor 1.02 accounts for the temperature offset of the LS MOSFET compared to the control circuit.

With the constant on-time architecture, HS is always turned on for a fixed on-time. This determines the peak-to-peak inductor current.

Current ripple ΔI is given by:

$$\Delta I_L = \frac{(V_{IN} - V_{OUT}) * t_{ON}}{L} \quad (22)$$

From the equation above, the worst-case ripple occurs during an output short circuit (where V_{OUT} is 0 V). This should be taken into account when selecting the current limit set point.

The FAN23SV04T uses valley-current sensing. The current limit (I_{ILIM}) set point is the valley (I_{VALLEY}).

The valley current level for calculating R_{ILIM} is given by:

$$I_{VALLEY} = I_{LOAD(CL)} - \frac{\Delta I_L}{2} \quad (23)$$

where $I_{LOAD(CL)}$ is the DC load current when the current limit threshold is reached.

For example: in a converter designed for 4 A steady-state operation and 1 A current ripple, the current-limit threshold could be selected at 120% of $I_{LOAD(SS)}$ to accommodate transient operation and inductor value decrease under loading. As a result; $I_{LOAD(SS)}$ is 4.8 A, $I_{VALLEY}=4.3$ A, and R_{ILIM} is selected as the standard value of 1.02 k Ω .

Boot Resistor

In some applications, especially with higher input voltage, the V_{SW} ring voltage may exceed the derating guidelines of 80% to 90% of absolute rating for V_{SW} . In this situation, a resistor can be connected in series with the boot capacitor (C3 in Figure 1) to reduce the turn-on speed of the high-side MOSFET to reduce the amplitude of the V_{SW} ring voltage.

PCB (Printed Circuit Board) Layout Guidelines

The following should be considered before beginning a PCB layout using the FAN23SV04T. A sample PCB layout from the evaluation board following the layout guidelines is shown in Figure 22 - Figure 25.

Power components consisting of the input capacitors, output capacitors, inductor, and FAN23SV04T device

should be on a common side of the PCB in close proximity to each other and connected using surface copper.

Sensitive analog components; including SS, FB, ILIM, FREQ, and EN; should be placed away from the high-voltage switching circuits, such as SW and BOOT, and connected to their respective pins with short traces.

The inner PCB layer closest to the FAN23SV04T device should have Power Ground (PGND) under the power-processing portion of the device (PVIN, SW, and PGND). This inner PCB layer should have a separate Analog Ground (AGND) under the P1 pad and the associated analog components. AGND and PGND should be connected together near the IC between PGND pins 18-21 and AGND pin 23, which connects to P1 thermal pad.

The AGND thermal pad (P1) should be connected to AGND plane on the inner layer using four 0.25 mm vias spread under the pad. No vias are included under PVIN (P2) and SW (P3) to maintain the PGND plane under the power circuitry intact.

Power circuit loops that carry high currents should be arranged to minimize the loop area. Primary focus should be directed to minimize the loop for current flow from the input capacitor to PVIN, through the internal MOSFETs, and returning to the input capacitor. The input capacitor should be placed as close to the PVIN terminals as possible.

The current return path from PGND at the low-side MOSFET source to the negative terminal of the input capacitor can be routed under the inductor and also through vias that connect the input capacitor and low-side MOSFET source to the PGND region under the power portion of the IC.

The SW node trace that connects the source of the high-side MOSFET and the drain of the low-side MOSFET to the inductor should be short and wide.

To control the voltage across the output capacitor, the output voltage divider should be located close to the FB pin, with the upper FB voltage divider resistor connected to the positive side of the output capacitor, and the bottom resistor should be connected to the AGND portion of the FAN23SV04T device.

When using ceramic capacitor solutions with external ramp injection circuitry (R2, C4, C5 in Figure 1), R2 and C4 should be connected near the inductor and coupling capacitor C5 should be placed near the FB pin to minimize FB pin trace length.

Decoupling capacitors for PVCC and VCC should be located close to their respective device pins.

SW node connections to BOOT, ILIM, and ripple injection resistor R2 should be through separate traces.

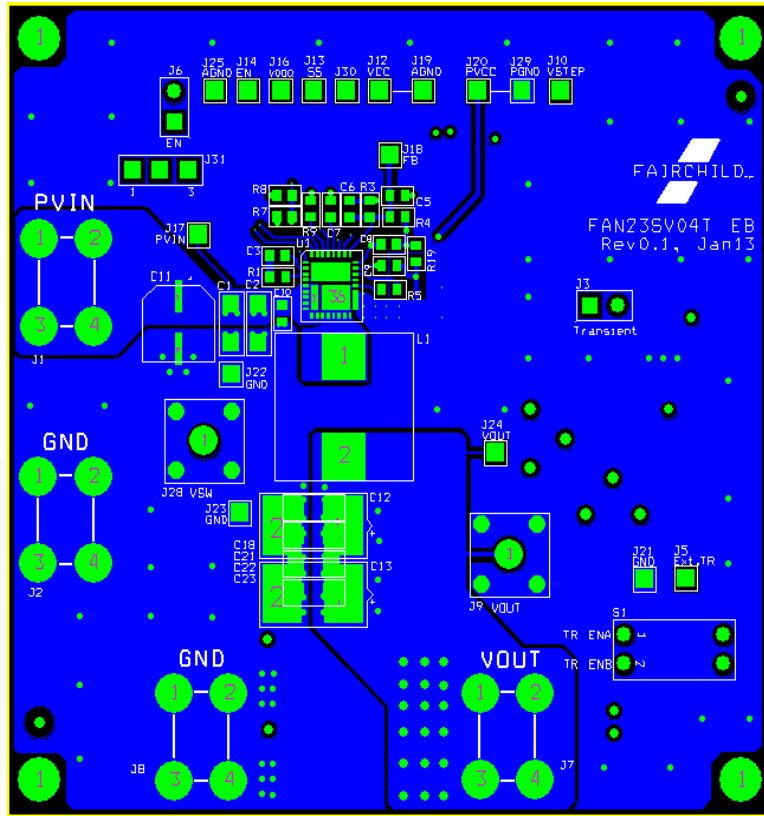

Figure 22. Evaluation Board Top Layer Copper

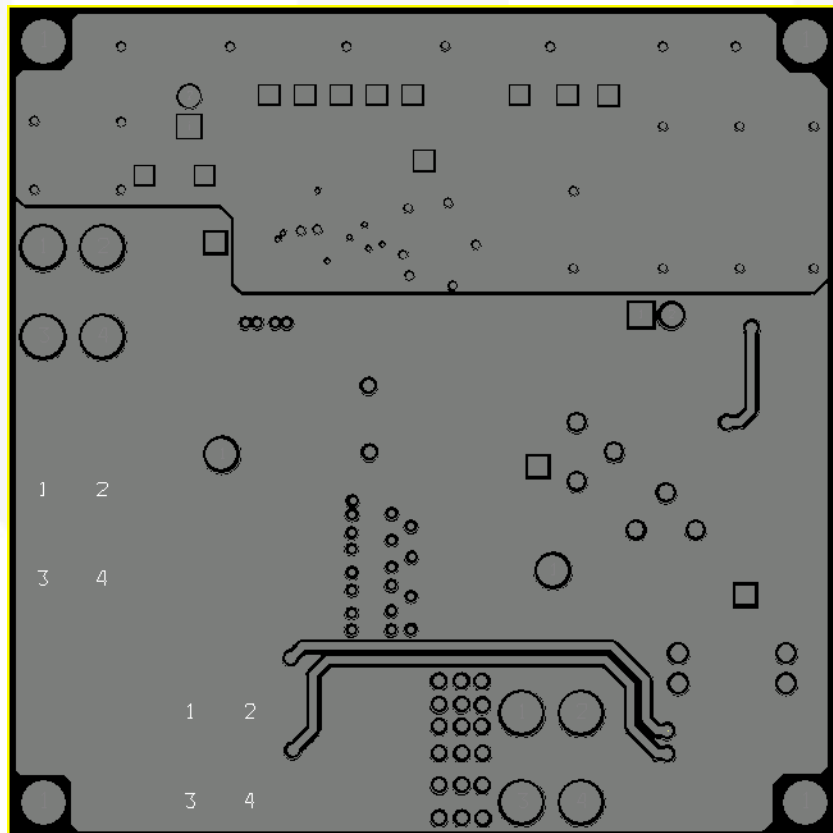

Figure 23. Evaluation Board Inner Layer 1 Copper

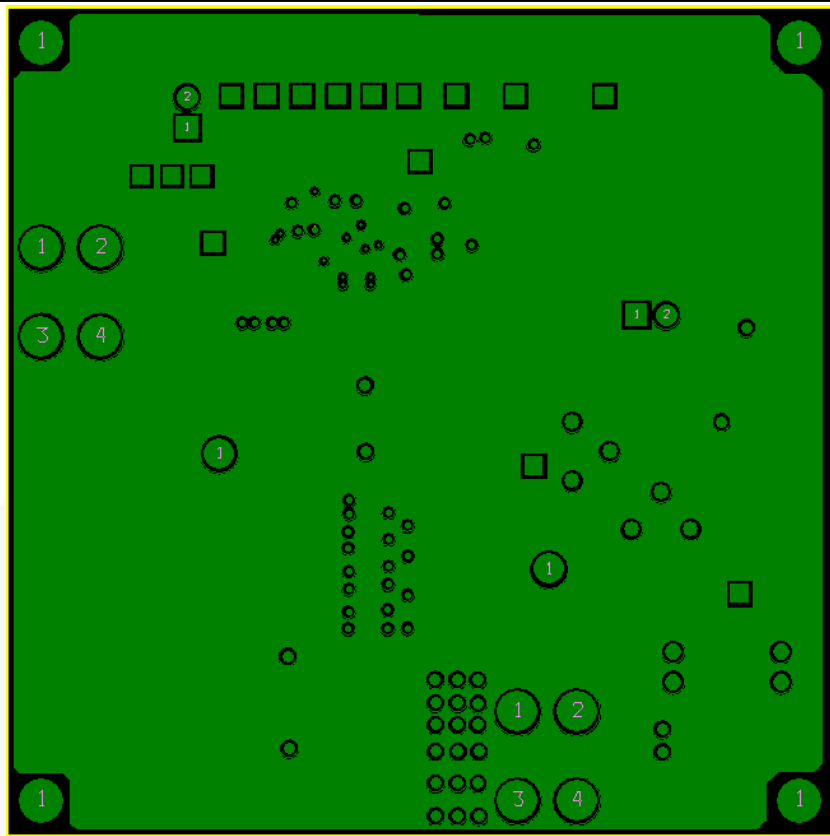

Figure 24. Evaluation Board Inner Layer 2 Copper

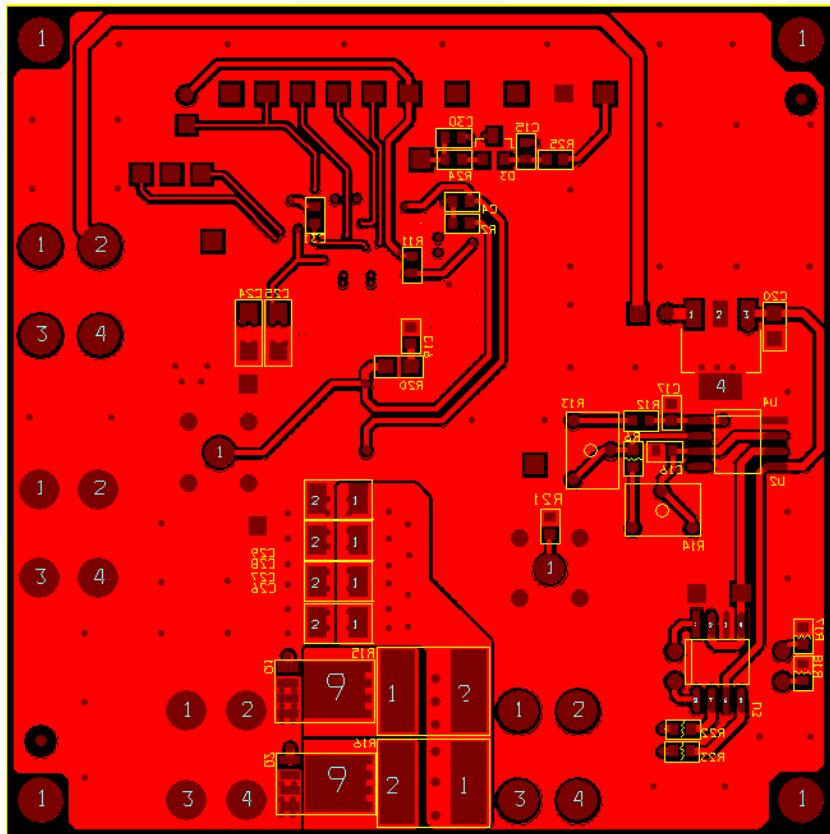
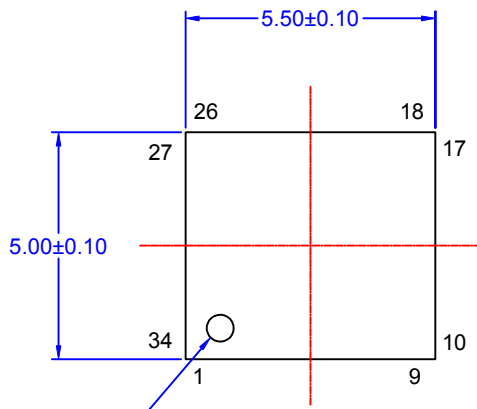
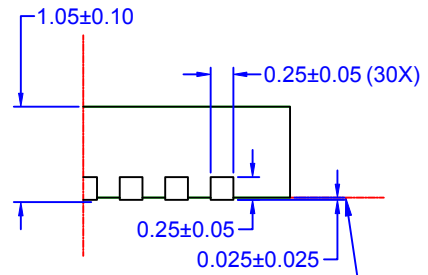

Figure 25. Evaluation Board Bottom Layer Copper



PIN#1
INDICATOR

TOP VIEW



DETAIL 'A'
SCALE: 2:1

SEATING
PLANE

SEE
DETAIL 'A'

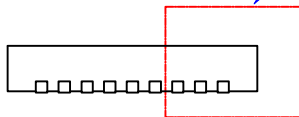

FRONT VIEW

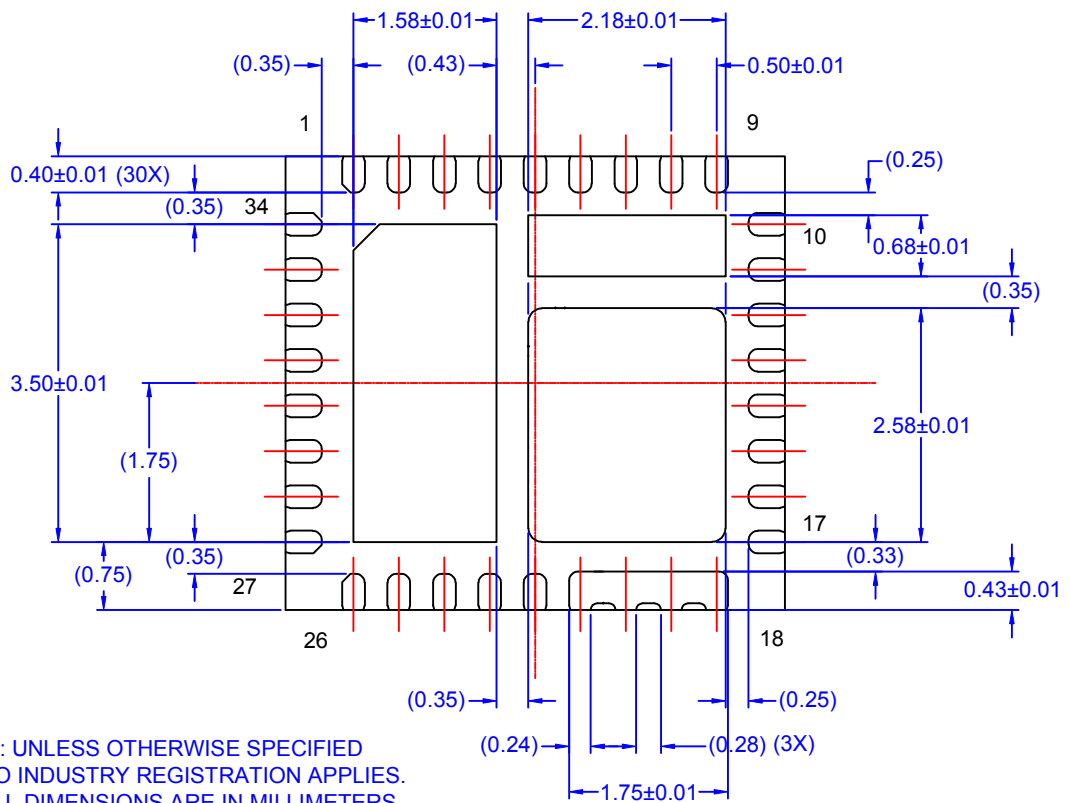

BOTTOM VIEW

- NOTES: UNLESS OTHERWISE SPECIFIED
- A) NO INDUSTRY REGISTRATION APPLIES.
 - B) ALL DIMENSIONS ARE IN MILLIMETERS.
 - C) DIMENSIONS DO NOT INCLUDE BURRS OR MOLD FLASH. MOLD FLASH OR BURRS DOES NOT EXCEED 0.10MM.
 - D) DIMENSIONING AND TOLERANCING PER ASME Y14.5M-2009.
 - E) DRAWING FILE NAME: MKT-PQFN34AREV2
 - F) FAIRCHILD SEMICONDUCTOR

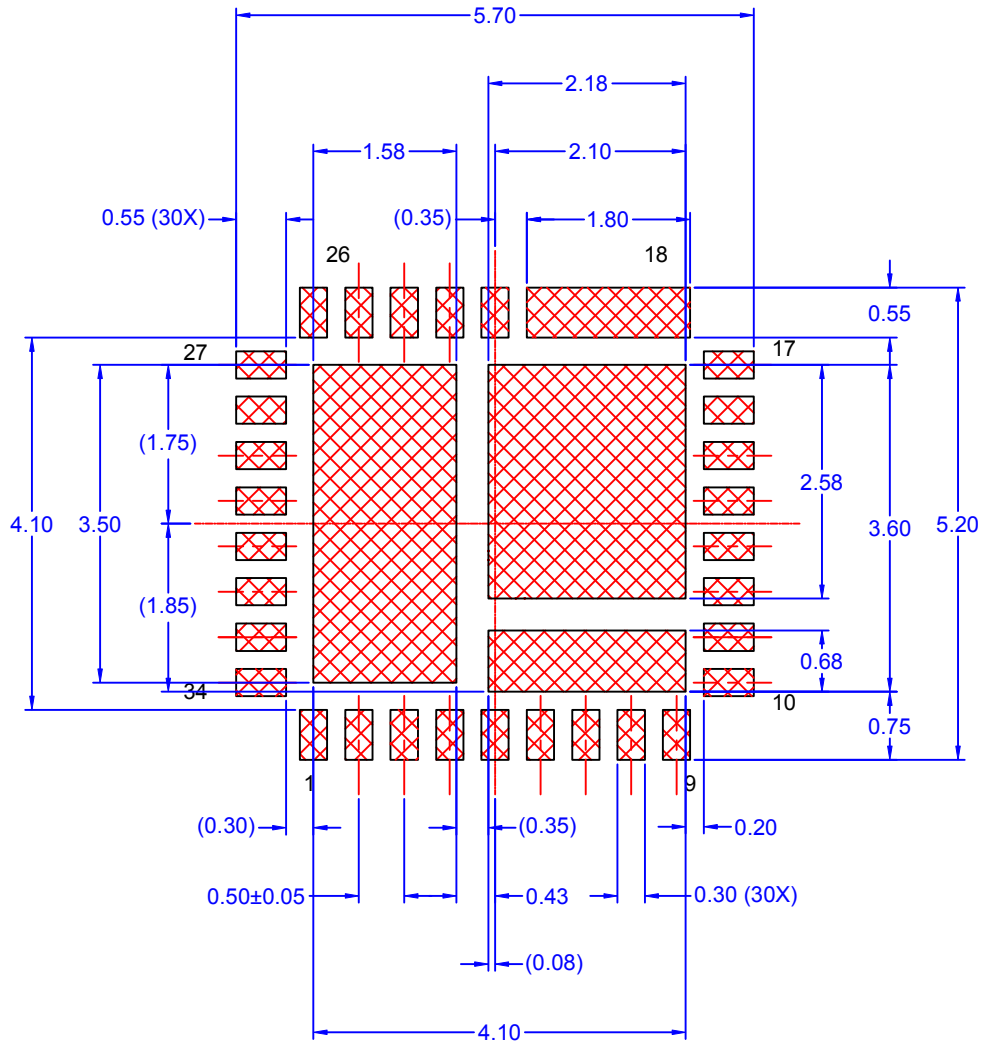

LAND PATTERN
 RECOMMENDATION

ON Semiconductor and  are trademarks of Semiconductor Components Industries, LLC dba ON Semiconductor or its subsidiaries in the United States and/or other countries. ON Semiconductor owns the rights to a number of patents, trademarks, copyrights, trade secrets, and other intellectual property. A listing of ON Semiconductor's product/patent coverage may be accessed at www.onsemi.com/site/pdf/Patent-Marking.pdf. ON Semiconductor reserves the right to make changes without further notice to any products herein. ON Semiconductor makes no warranty, representation or guarantee regarding the suitability of its products for any particular purpose, nor does ON Semiconductor assume any liability arising out of the application or use of any product or circuit, and specifically disclaims any and all liability, including without limitation special, consequential or incidental damages. Buyer is responsible for its products and applications using ON Semiconductor products, including compliance with all laws, regulations and safety requirements or standards, regardless of any support or applications information provided by ON Semiconductor. "Typical" parameters which may be provided in ON Semiconductor data sheets and/or specifications can and do vary in different applications and actual performance may vary over time. All operating parameters, including "Typicals" must be validated for each customer application by customer's technical experts. ON Semiconductor does not convey any license under its patent rights nor the rights of others. ON Semiconductor products are not designed, intended, or authorized for use as a critical component in life support systems or any FDA Class 3 medical devices or medical devices with a same or similar classification in a foreign jurisdiction or any devices intended for implantation in the human body. Should Buyer purchase or use ON Semiconductor products for any such unintended or unauthorized application, Buyer shall indemnify and hold ON Semiconductor and its officers, employees, subsidiaries, affiliates, and distributors harmless against all claims, costs, damages, and expenses, and reasonable attorney fees arising out of, directly or indirectly, any claim of personal injury or death associated with such unintended or unauthorized use, even if such claim alleges that ON Semiconductor was negligent regarding the design or manufacture of the part. ON Semiconductor is an Equal Opportunity/Affirmative Action Employer. This literature is subject to all applicable copyright laws and is not for resale in any manner.

PUBLICATION ORDERING INFORMATION

LITERATURE FULFILLMENT:

Literature Distribution Center for ON Semiconductor
19521 E. 32nd Pkwy, Aurora, Colorado 80011 USA
Phone: 303-675-2175 or 800-344-3860 Toll Free USA/Canada
Fax: 303-675-2176 or 800-344-3867 Toll Free USA/Canada
Email: orderlit@onsemi.com

N. American Technical Support: 800-282-9855 Toll Free
USA/Canada
Europe, Middle East and Africa Technical Support:
Phone: 421 33 790 2910
Japan Customer Focus Center
Phone: 81-3-5817-1050

ON Semiconductor Website: www.onsemi.com
Order Literature: <http://www.onsemi.com/orderlit>
For additional information, please contact your local
Sales Representative