

Single and Dual, Rail-to-Rail I/O, CMOS Amplifier

FAN4174, FAN4274

Description

The FAN4174 (single) and FAN4274 (dual) are voltage feedback amplifiers with CMOS inputs that consume only 200 μA of supply current per amplifier, while providing $\pm 33\text{ mA}$ of output short-circuit current. These amplifiers are designed to operate 5 V supplies. The common mode voltage range extends beyond the negative and positive rails.

The FAN4174 and FAN4274 are designed on a CMOS process and provide 3.7 MHz of bandwidth and 3 V / μs of slew rate at a supply voltage of 5 V.

These amplifiers operate and are reliable over a wide temperature range of -40°C to $+125^\circ\text{C}$.

The combination of extended temperature operation, low power, rail-to-rail performance, low-voltage operation, and a tiny package optimize this amplifier family for use in many industrial, general-purpose, and battery-powered applications.

Features

- 200 μA Supply Current per Amplifier
- 3.7 MHz Bandwidth
- Output Swing to Within 10 mV of Either Rail
- Input Voltage Range Exceeds the Rails
- 3 V/ μs Slew Rate
- 25 nV/ $\sqrt{\text{Hz}}$ Input Voltage Noise
- Replaces KM4170 and KM4270
- FAN4174 Competes with OPA340 and TLV2461; Available in a SOT23-5 Package
- FAN4274 Competes with OPA2340 and TLV2462; Available in MSOP-8 Package
- Fully Specified at +5 V Supplies
- These are Pb-Free Devices

Applications

- Motor Control
- Portable / Battery-powered Applications
- PCMCIA, USB
- Mobile Communications, Cellular Phones, Pagers
- Notebooks and PDAs
- Sensor Interface
- A/D Buffer
- Active Filters
- Signal Conditioning
- Portable Test Instruments



ON Semiconductor®

www.onsemi.com

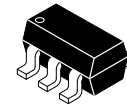

SOT-23, 5 Lead
CASE 527AH-01

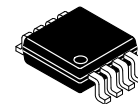

Micro8
CASE 846A-02

MARKING DIAGRAM

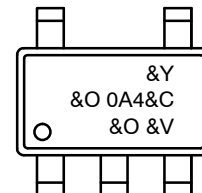

- 0A4 = Specific Device Code
- &Y = Binary Year Coding
- &O = Plant Code Identifier
- &C = Single Digit Die Run Code
- &V = Eight-Week Data Coding

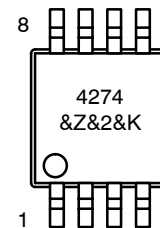

- 4274 = Specific Device Code
- &Z = Assembly Plant Code
- &2 = 2-Digit Date Code
- &K = 2-Digits Lot Run Traceability Code

ORDERING INFORMATION

See detailed ordering and shipping information on page 12 of this data sheet.

FAN4174, FAN4274

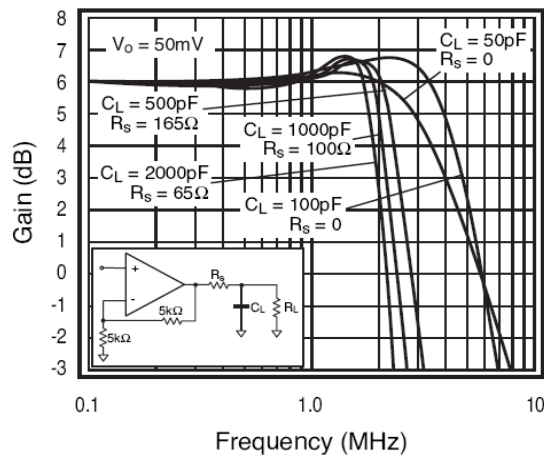

Figure 1. Frequency vs. Gain

TYPICAL APPLICATION

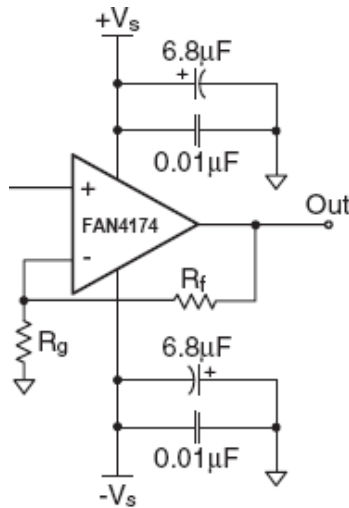

Figure 2. Typical Application Circuit

PIN CONFIGURATIONS

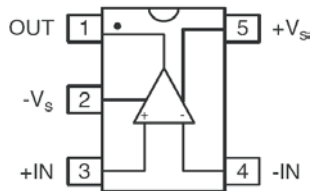

Figure 3. FAN4174 (SOT23)

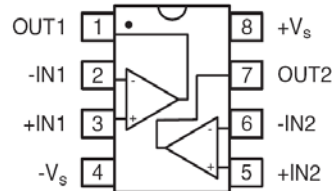

Figure 4. FAN4274 (MSOP)

FAN4174, FAN4274

FAN4174 PIN ASSIGNMENTS

Pin No.	Name	Description
1	OUT	Output
2	-V _S	Negative Supply
3	+IN	Positive Supply
4	-IN	Negative Input
5	+V _S	Positive Supply

FAN4274 PIN ASSIGNMENTS

Pin No.	Name	Description
1	OUT1	Output, Channel 1
2	-IN1	Negative Input, Channel 1
3	+IN1	Positive Input, Channel 1
4	-V _S	Negative Supply
5	+IN2	Positive Input, Channel 2
6	-IN2	Negative Input, Channel 2
7	OUT2	Output, Channel 2
8	+V _S	Positive Supply

ABSOLUTE MAXIMUM RATINGS

Symbol	Parameter	Min	Max	Unit	
V _{CC}	Supply Voltage	0	6	V	
V _{IN}	Input Voltage Range	-V _S - 0.5	+V _S + 0.5	V	
T _J	Junction Temperature	-	+150	°C	
T _{STG}	Storage Temperature	-65	+150	°C	
T _L	Lead Soldering, 10 Seconds	-	+300	°C	
Θ _{JA}	Thermal Resistance (Note 1)	5-Lead SOT23	-	256	°C/W
		8-Lead MSOP	-	206	

Stresses exceeding those listed in the Maximum Ratings table may damage the device. If any of these limits are exceeded, device functionality should not be assumed, damage may occur and reliability may be affected.

1. Package thermal resistance JEDEC standard, multi-layer test boards, still air.

RECOMMENDED OPERATING CONDITIONS

Symbol	Parameter	Min	Max	Unit
+V _S	Supply Voltage	2.30	5.25	V
T _A	Operating Temperature Range	-40	+125	°C

Functional operation above the stresses listed in the Recommended Operating Ranges is not implied. Extended exposure to stresses beyond the Recommended Operating Ranges limits may affect device reliability.

FAN4174, FAN4274

ELECTRICAL SPECIFICATIONS AT +2.7 V ($V_S = +2.7$ V, $G = 2$, $R_L = 10$ k Ω to $V_S / 2$, $R_F = 5$ k Ω ; unless otherwise noted)

Symbol	Parameter	Conditions	Min	Typ	Max	Unit
--------	-----------	------------	-----	-----	-----	------

FREQUENCY DOMAIN RESPONSE

UGBW	-3 dB Bandwidth	$G = +1$	-	4.0	-	MHz
BW _{SS}			-	2.5	-	MHz
GBWP	Gain Bandwidth Product		-	4	-	MHz

TIME DOMAIN RESPONSE

t_R, f_F	Rise and Fall Time	$V_O = 1.0$ V Step	-	300	-	ns
OS	Overshoot	$V_O = 1.0$ V Step	-	5	-	%
SR	Slew Rate	$V_O = 3$ V Step, $G = -1$	-	3	-	V/ μ s

DISTORTION AND NOISE RESPONSE

HD2	2nd Harmonic Distortion	$V_O = 1$ V _{PP} , 10 kHz	-	-66	-	dBc
HD3	3rd Harmonic Distortion	$V_O = 1$ V _{PP} , 10 kHz	-	-67	-	dBc
THD	Total Harmonic Distortion	$V_O = 1$ V _{PP} , 10 kHz	-	0.1	-	%
e_n	Input Voltage Noise		-	26	-	nV/ \sqrt Hz
X _{TALK}	Crosstalk (FAN4274)	100 kHz	-	-100	-	dB

DC PERFORMANCE

V_{IO}	Input Offset Voltage (Note 2)		-6	0	+6	mV
d V_{IO}	Average Drift		-	2.1	-	μ V/ $^{\circ}$ C
I_{bn}	Input Bias Current		-	5	-	pA
PSRR	Power Supply Rejection Ratio (Note 2)	DC	50	73	-	dB
A _{OL}	Open-loop Gain	DC	-	98	-	dB
I_S	Supply Current per Amplifier (Note 2)		-	200	300	μ A

INPUT CHARACTERISTICS

R_{IN}	Input Resistance		-	10	-	G Ω	
C_{IN}	Input Capacitance		-	1.4	-	pF	
CMIR	Input Common Mode Voltage Range		-	-0.3 to 2.8	-	V	
CMRR	Common Mode Rejection Ratio (Note 2)	FAN4174	DC, $V_{CM} = 0$ V to 2.2 V	50	65	-	dB
		FAN4274	DC, $V_{CM} = 0$ V to 2.2 V	50	65	-	

OUTPUT CHARACTERISTICS

V_O	Output Voltage Swing (Note 2)	$R_L = 10$ k Ω to $V_S / 2$	0.03	0.01 to 2.69	2.65	V
		$R_L = 1$ k Ω to $V_S / 2$	-	0.05 to 2.55	-	
I_{SC}	Short-Circuit Output Current		-	+34 / -12	-	mA
V_S	Power Supply Operating Range		-	2.5 to 5.5	-	V

Product parametric performance is indicated in the Electrical Characteristics for the listed test conditions, unless otherwise noted. Product performance may not be indicated by the Electrical Characteristics if operated under different conditions.

2. 100% tested at 25 $^{\circ}$ C.

FAN4174, FAN4274

ELECTRICAL SPECIFICATIONS AT +5 V ($V_S = +5\text{ V}$, $G = 2$, $R_L = 10\text{ k}\Omega$ to $V_S / 2$, $R_F = 5\text{ k}\Omega$; unless otherwise noted)

Symbol	Parameter	Conditions	Min	Typ	Max	Unit
--------	-----------	------------	-----	-----	-----	------

FREQUENCY DOMAIN RESPONSE

UGBW	-3dB Bandwidth	$G = +1$, $T_A = 85^\circ\text{C}$	-	3.7	-	MHz
		$G = +1$, $T_A = 125^\circ\text{C}$	-	3.2	-	
BW _{SS}			-	2.3	-	MHz
GBWP	Gain Bandwidth Product	$T_A = 85^\circ\text{C}$	-	3.7	-	MHz
		$T_A = 125^\circ\text{C}$	-	3.2	-	

TIME DOMAIN RESPONSE

t_R, t_F	Rise and Fall Time	$V_O = 1.0\text{ V Step}$	-	300	-	ns
OS	Overshoot	$V_O = 1.0\text{ V Step}$	-	5	-	%
SR	Slew Rate	$V_O = 3\text{ V Step}$, $G = -1$	-	3	-	V/ μs

DISTORTION AND NOISE RESPONSE

HD2	2nd Harmonic Distortion	$V_O = 1\text{ V}_{PP}$, 10 kHz	-	-80	-	dBc
HD3	3rd Harmonic Distortion	$V_O = 1\text{ V}_{PP}$, 10 kHz	-	-80	-	dBc
THD	Total Harmonic Distortion	$V_O = 1\text{ V}_{PP}$, 10 kHz	-	0.02	-	%
e_n	Input Voltage Noise		-	25	-	nV/ $\sqrt{\text{Hz}}$
X _{TALK}	Crosstalk (FAN4274)	100 kHz	-	-100	-	dB

DC PERFORMANCE

V_{IO}	Input Offset Voltage ⁽³⁾		-8	0	+8	mV
d V_{IO}	Average Drift		-	2.9	-	$\mu\text{V}/^\circ\text{C}$
I_{bn}	Input Bias Current		-	5	-	pA
PSRR	Power Supply Rejection Ratio (Note 3)	DC	50	73	-	dB
A_{OL}	Open-loop Gain	DC	-	102	-	dB
I_S	Supply Current per Amplifier ⁽³⁾		-	200	300	μA

INPUT CHARACTERISTICS

R_{IN}	Input Resistance		-	10	-	GW
C_{IN}	Input Capacitance		-	1.2	-	pF
CMIR	Input Common Mode Voltage Range		-	-0.3 to 5.1	-	V
CMRR	Common Mode Rejection Ratio (Note 3)	DC, $V_{CM} = 0\text{ V to }V_S$	58	73	-	dB

OUTPUT CHARACTERISTICS

V_O	Output Voltage Swing (Note 3)	$R_L = 10\text{ k}\Omega$ to $V_S / 2$	0.03	0.01 to 4.99	4.95	V
		$R_L = 1\text{ k}\Omega$ to $V_S / 2$	-	0.1 to 4.9	-	
I_{SC}	Short-Circuit Output Current		-	± 33	-	mA
V_S	Power Supply Operating Range		-	2.5 to 5.5	-	V

Product parametric performance is indicated in the Electrical Characteristics for the listed test conditions, unless otherwise noted. Product performance may not be indicated by the Electrical Characteristics if operated under different conditions.

3. 100% tested at 25°C.

TYPICAL PERFORMANCE CHARACTERISTICS

($V_S = +2.7\text{ V}$, $G = 2$, $R_L = 10\text{ k}\Omega$ to $V_S / 2$, $R_F = 5\text{ k}\Omega$; unless otherwise noted)

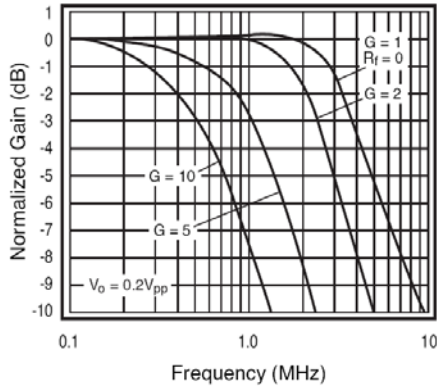

Figure 5. Non-Inverting Frequency Response (+5 V)

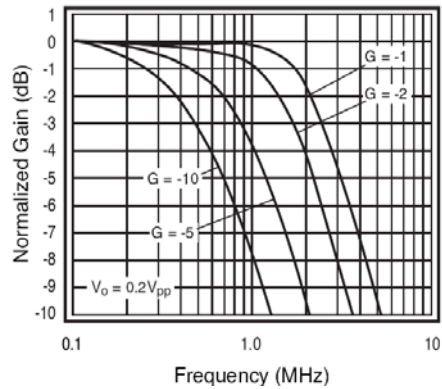

Figure 6. Inverting Frequency Response (+5 V)

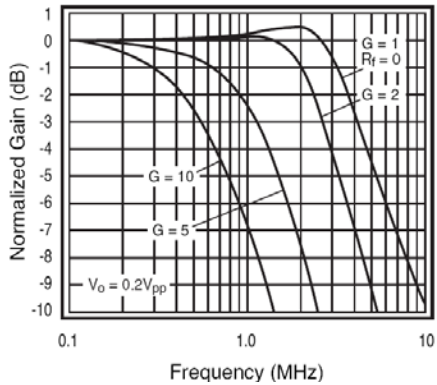

Figure 7. Non-Inverting Frequency Response

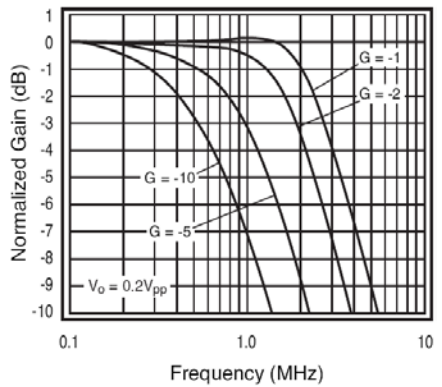

Figure 8. Inverting Frequency Response

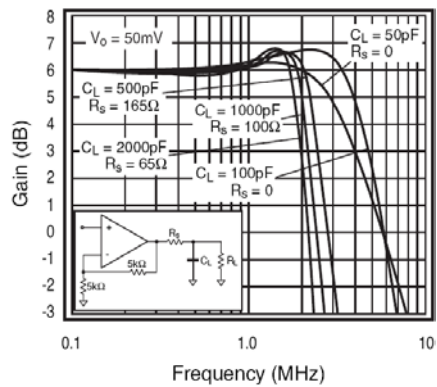

Figure 9. Frequency Response vs. C_L

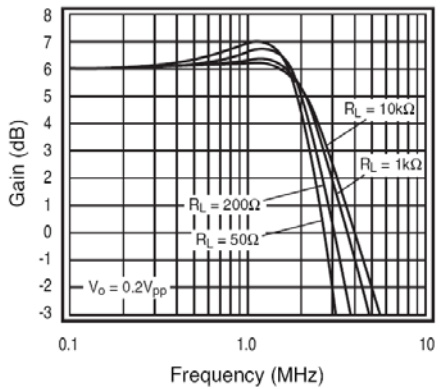

Figure 10. Open-loop Gain and Phase vs. Frequency

FAN4174, FAN4274

TYPICAL PERFORMANCE CHARACTERISTICS

($V_S = +2.7\text{ V}$, $G = 2$, $R_L = 10\text{ k}\Omega$ to $V_S / 2$, $R_F = 5\text{ k}\Omega$; unless otherwise noted) (continued)

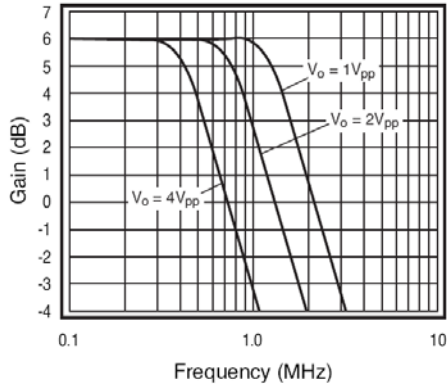

Figure 11. Large Signal Frequency Response (+5 V)

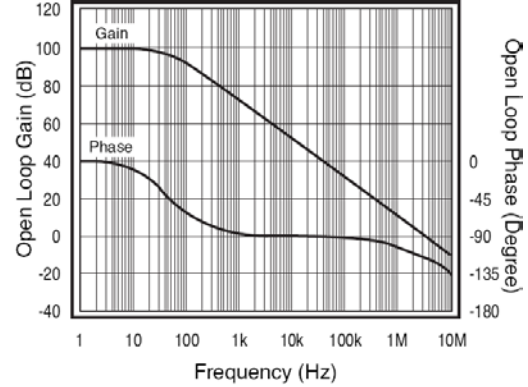

Figure 12. Open-loop Gain and Phase vs. Frequency

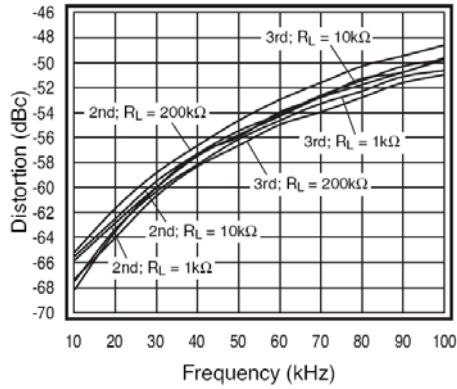

Figure 13. 2nd and 3rd Harmonic Distortion

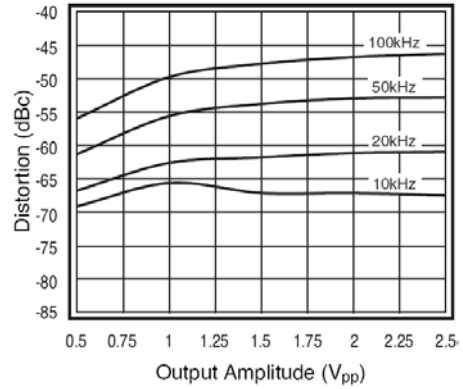

Figure 14. 2nd Harmonic Distortion vs. V_O

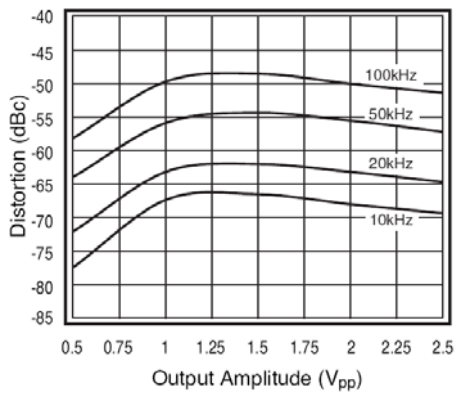

Figure 15. 3rd Harmonic Distortion vs. V_O

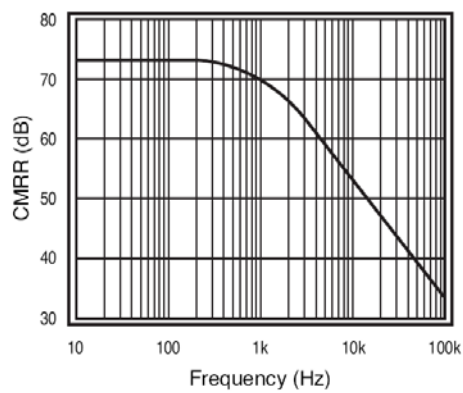

Figure 16. CMRR $V_S = 5\text{ V}$

FAN4174, FAN4274

TYPICAL PERFORMANCE CHARACTERISTICS

($V_S = +2.7\text{ V}$, $G = 2$, $R_L = 10\text{ k}\Omega$ to $V_S / 2$, $R_F = 5\text{ k}\Omega$; unless otherwise noted) (continued)

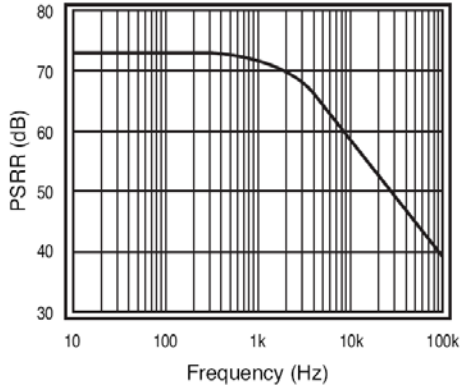

Figure 17. PSRR $V_S = 5\text{ V}$

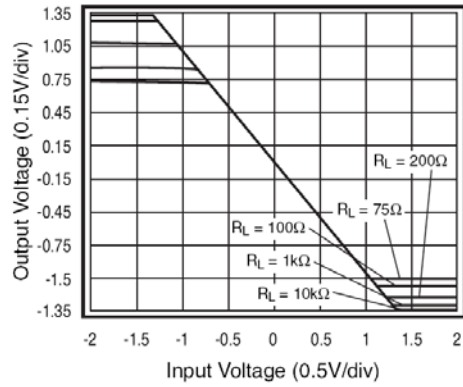

Figure 18. Output Swing vs. Load

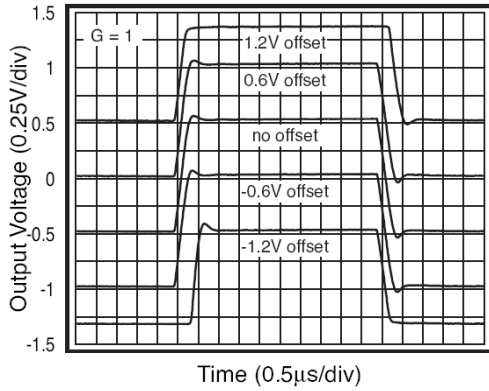

Figure 19. Pulse Response vs. Common-Mode Voltage

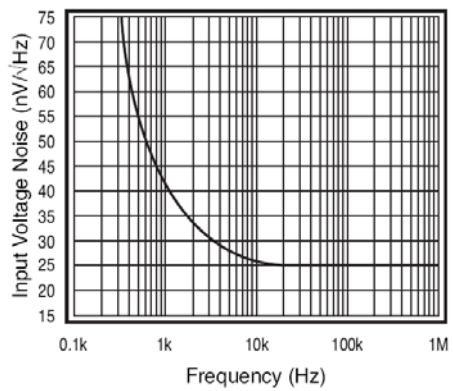

Figure 20. Input Voltage Noise

APPLICATION INFORMATION

General Description

The FAN4174 amplifier includes single-supply, general-purpose, voltage-feedback amplifiers, fabricated on a bi-CMOS process. The family features a rail-to-rail input and output and is unity gain stable. The typical non-inverting circuit schematic is shown in Figure 21.

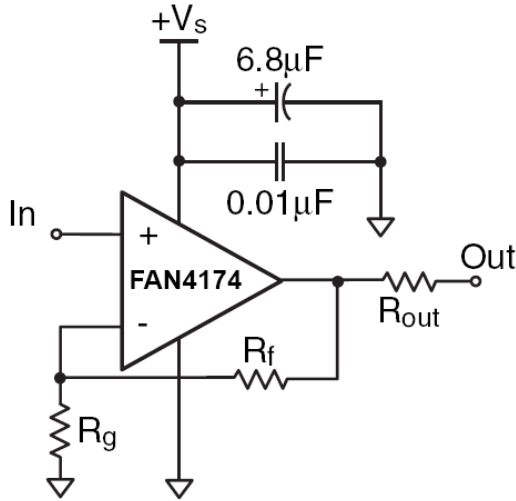

Figure 21. Typical Non-inverting Configuration

Input Common Mode Voltage

The common mode input range extends to 300 mV below ground and to 100 mV above V_S in single supply operation. Exceeding these values does not cause phase reversal; however, if the input voltage exceeds the rails by more than 0.5 V, the input ESD devices begin to conduct. The output stays at the rail during this overdrive condition. If the absolute maximum input V_{IN} (700 mV beyond either rail) is exceeded, externally limit the input current to ± 5 mA, as shown in Figure 22.

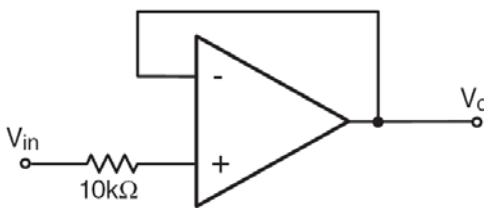

Figure 22. Circuit for Input Current Protection

Power Dissipation

The maximum internal power dissipation allowed is directly related to the maximum junction temperature. If the maximum junction temperature exceeds 150°C, performance degradation occurs. If the maximum junction temperature exceeds 150°C for an extended time, device failure may occur.

Overdrive Recovery

Overdrive of an amplifier occurs when the output and/or input ranges are exceeded. The recovery time varies based on whether the input or output is overdriven and by how much the range is exceeded. The FAN4174 typically recovers in less than 500 ns from an overdrive condition. Figure 23 shows the FAN4174 amplifier in an overdriven condition.

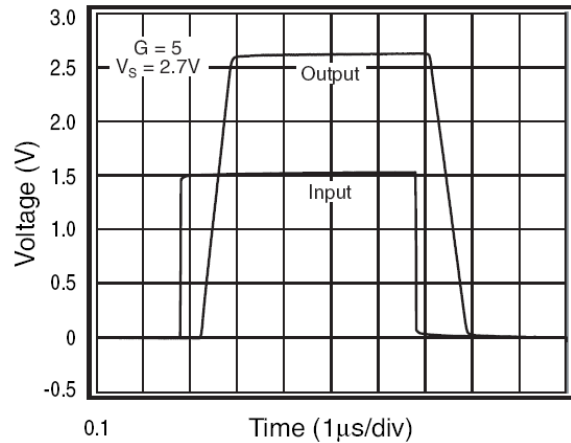

Figure 23. Overdrive Recovery

Driving Capacitive Loads

Figure 9 illustrates the response of the FAN4174 amplifier. A small series resistance (R_S) at the output of the amplifier, illustrated in Figure 24, improves stability and settling performance. R_S values in Figure 9 achieve maximum bandwidth with less than 2 dB of peaking. For maximum flatness, use a larger R_S . Capacitive loads larger than 500 pF require the use of R_S .

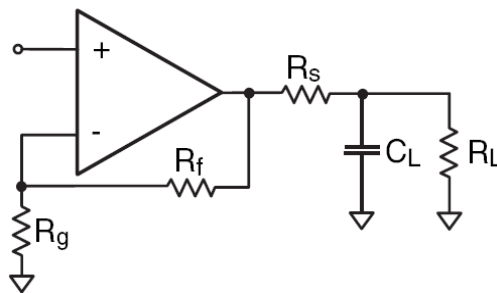

Figure 24. Typical Topology for Driving a Capacitive Load

Driving a capacitive load introduces phase-lag into the output signal, which reduces phase margin in the amplifier. The unity gain follower is the most sensitive configuration. In a unity gain follower configuration, the FAN4174 amplifier requires a 300 Ω series resistor to drive a 100 pF load.

FAN4174, FAN4274

LAYOUT CONSIDERATIONS

General layout and supply bypassing play major roles in high-frequency performance. ON Semiconductor evaluation boards help guide high-frequency layout and aid in device testing and characterization. Follow the steps below as a basis for high-frequency layout:

1. Include 6.8 μF and 0.01 μF ceramic capacitors.
2. Place the 6.8 μF capacitor within 19.05 mm (0.75 inches) of the power pin.
3. Place the 0.01 μF capacitor within 2.54 mm (0.1 inches) of the power pin.
4. Remove the ground plane under and around the part, especially near the input and output pins, to reduce parasitic capacitance.

Minimize all trace lengths to reduce series inductances.

Refer to the evaluation board layouts shown in Figure 27 through Figure 30 for more information.

When evaluating only one channel, complete the following on the unused channel:

1. Ground the non-inverting input.
2. Short the output to the inverting input.

EVALUATION BOARD INFORMATION

The following evaluation boards are available to aid in the testing and layout of this device:

Table 1.

Board	Description	Product
KEB002	Single Channel, Dual Supply, 5 and 6-Lead SOT23	FAN4174IS5X
KEB010	Dual Channel, Dual Supply 8-Lead MSOP	FAN4274IMU8X

Evaluation board schematics are shown in Figure 25 and Figure 26; layouts are shown in Figure 27 through Figure 30.

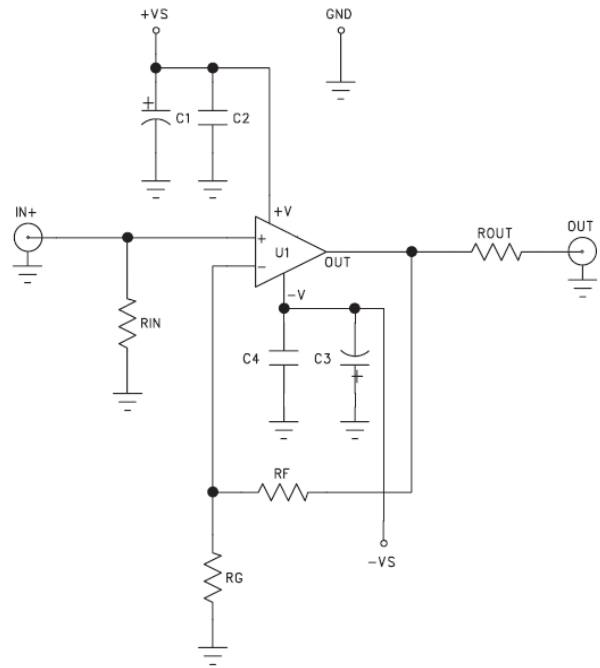

Figure 25. FAN4174 Evaluation Board Schematic (KEV002)

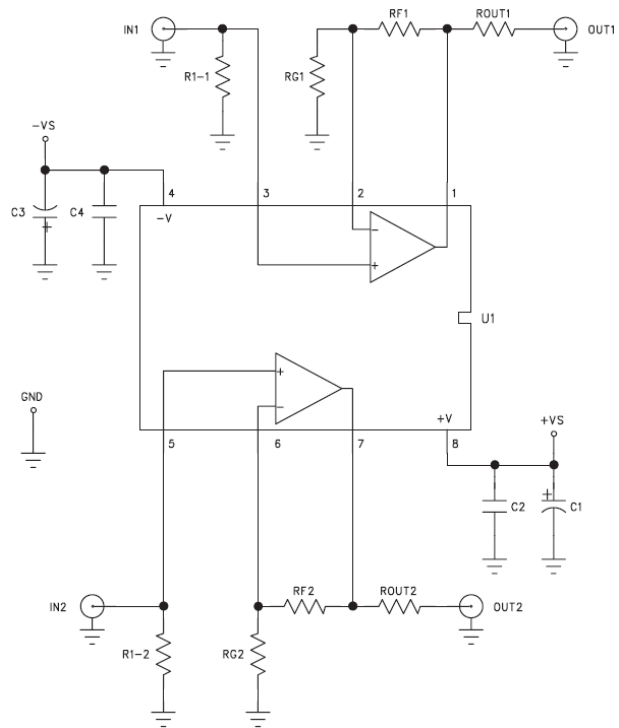

Figure 26. FAN4274 Evaluation Board Schematic (KEB010)

BOARD LAYOUT INFORMATION

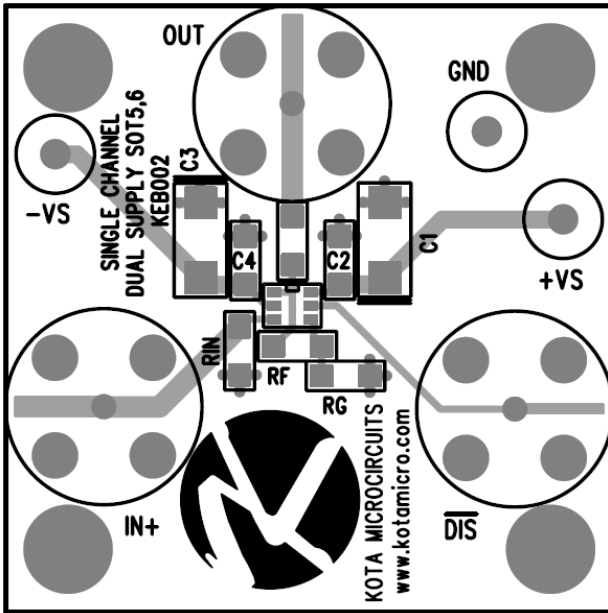

Figure 27. KEB002 (Top Side)

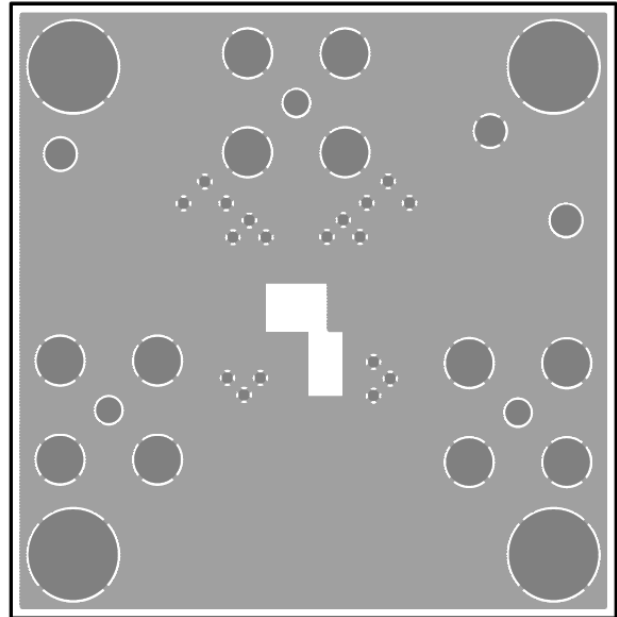

Figure 28. KEB002 (Bottom Side)

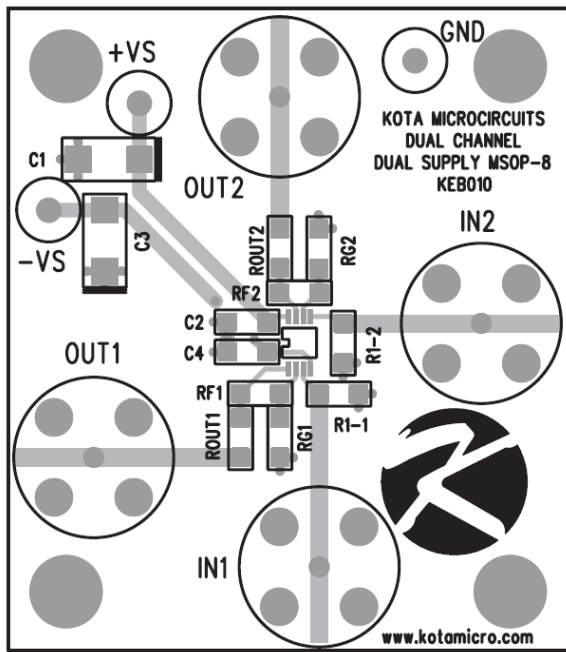

Figure 29. KEB010 (Top Side)

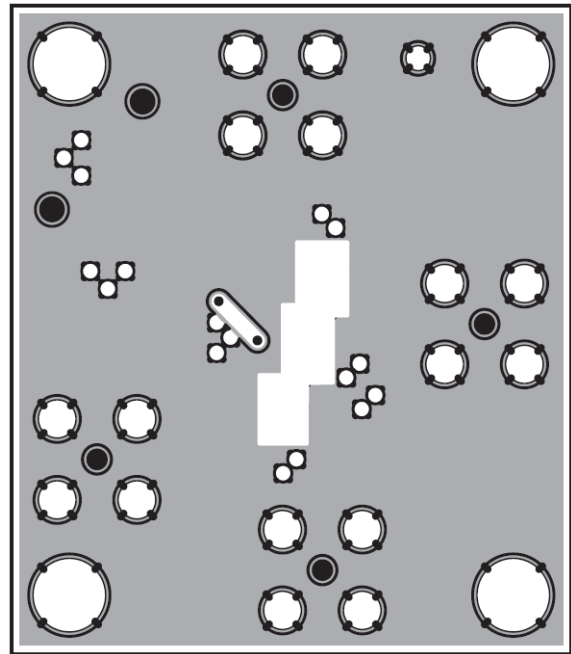

Figure 30. KEB010 (Bottom Side)

FAN4174, FAN4274

ORDERING INFORMATION

Device	Operating Temperature Range	Package	Shipping [†]
FAN4174IS5X	-40 to +125°C	SOT-23, 5 Lead (Pb-Free)	3000 / Tape & Reel
FAN4274IMU8X	-40 to +125°C	Micro8, Lead Molded Small-Outline (Pb-Free)	3000 / Tape & Reel

[†]For information on tape and reel specifications, including part orientation and tape sizes, please refer to our Tape and Reel Packaging Specifications Brochure, BRD8011/D.

MECHANICAL CASE OUTLINE PACKAGE DIMENSIONS

ON Semiconductor®

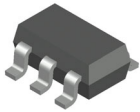

SOT-23, 5 Lead CASE 527AH ISSUE A

DATE 09 JUN 2021

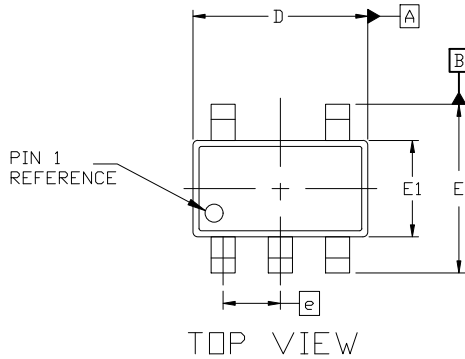

NOTES:

1. DIMENSIONING AND TOLERANCING PER ASME Y14.5M, 1989A
2. CONTROLLING DIMENSION: MILLIMETERS
3. MAXIMUM LEAD THICKNESS INCLUDES LEAD FINISH THICKNESS. MINIMUM LEAD THICKNESS IS THE MINIMUM THICKNESS OF THE BASE MATERIAL.
4. DIMENSIONS D AND E1 DO NOT INCLUDE MOLD FLASH, PROTRUSIONS, OR GATE BURRS. MOLD FLASH, PROTRUSIONS, OR GATE BURRS SHALL NOT EXCEED 0.25 PER SIDE. D AND E1 DIMENSIONS ARE DETERMINED AT DATUM D.
5. DIMENSION 'b' DOES NOT INCLUDE DAMBAR PROTRUSION. ALLOWABLE DAMBAR PROTRUSION SHALL BE 0.08mm TOTAL IN EXCESS OF THE 'b' DIMENSION AT MAXIMUM MATERIAL CONDITION. MINIMUM SPACE BETWEEN PROTRUSION AND AN ADJACENT LEAD SHALL NOT BE LESS THAN 0.07mm.

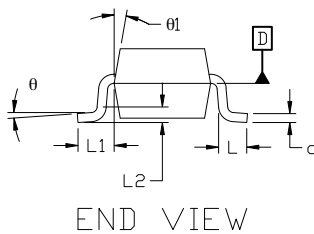
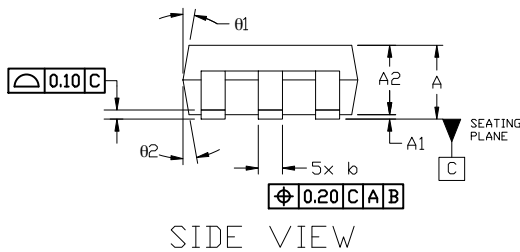

DIM	MILLIMETERS		
	MIN.	NOM.	MAX.
A	0.90	—	1.45
A1	0.00	—	0.15
A2	0.90	1.15	1.30
b	0.30	—	0.50
c	0.08	—	0.22
D	2.90 BSC		
E	2.80 BSC		
E1	1.60 BSC		
e	0.95 BSC		
L	0.30	0.45	0.60
L1	0.60 REF		
L2	0.25 REF		
theta	0°	4°	8°
theta1	0°	10°	15°
theta2	0°	10°	15°

GENERIC MARKING DIAGRAM*

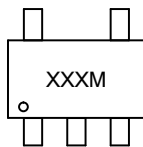

XXX = Specific Device Code
M = Date Code

*This information is generic. Please refer to device data sheet for actual part marking. Pb-Free indicator, "G" or microdot "•", may or may not be present. Some products may not follow the Generic Marking.

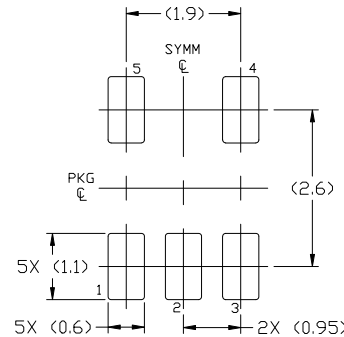

For additional information on our Pb-Free strategy and soldering details, please download the ON Semiconductor Soldering and Mounting Techniques Reference Manual, SOLDERRM/D.

DOCUMENT NUMBER:	98AON34320E	Electronic versions are uncontrolled except when accessed directly from the Document Repository. Printed versions are uncontrolled except when stamped "CONTROLLED COPY" in red.
DESCRIPTION:	SOT-23, 5 LEAD	PAGE 1 OF 1

ON Semiconductor and ON are trademarks of Semiconductor Components Industries, LLC dba ON Semiconductor or its subsidiaries in the United States and/or other countries. ON Semiconductor reserves the right to make changes without further notice to any products herein. ON Semiconductor makes no warranty, representation or guarantee regarding the suitability of its products for any particular purpose, nor does ON Semiconductor assume any liability arising out of the application or use of any product or circuit, and specifically disclaims any and all liability, including without limitation special, consequential or incidental damages. ON Semiconductor does not convey any license under its patent rights nor the rights of others.

MECHANICAL CASE OUTLINE

PACKAGE DIMENSIONS

ON Semiconductor®



SCALE 2:1

Micro8 CASE 846A-02 ISSUE K

DATE 16 JUL 2020

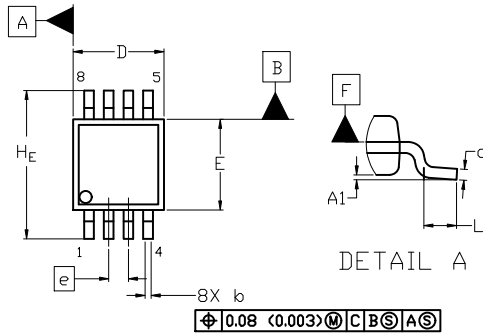

TOP VIEW

NOTE 3

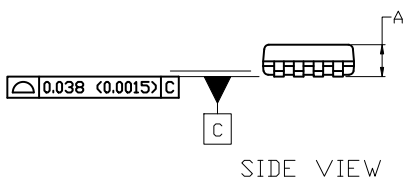

SIDE VIEW

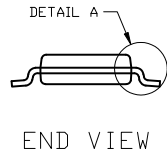

END VIEW

NOTES:

1. DIMENSIONING AND TOLERANCING PER ASME Y14.5M, 2009.
2. CONTROLLING DIMENSION: MILLIMETERS
3. DIMENSION *b* DOES NOT INCLUDE DAMBAR PROTRUSION. ALLOWABLE PROTRUSION SHALL BE 0.10 mm IN EXCESS OF MAXIMUM MATERIAL CONDITION.
4. DIMENSIONS *D* AND *E* DO NOT INCLUDE MOLD FLASH, PROTRUSION OR GATE BURRS. MOLD FLASH, PROTRUSIONS, OR GATE BURRS SHALL NOT EXCEED 0.15 mm PER SIDE. DIMENSION *E* DOES NOT INCLUDE INTERLEAD FLASH OR PROTRUSION. INTERLEAD FLASH OR PROTRUSION SHALL NOT EXCEED 0.25 mm PER SIDE. DIMENSIONS *D* AND *E* ARE DETERMINED AT DATUM *F*.
5. DATUMS *A* AND *B* ARE TO BE DETERMINED AT DATUM *F*.
6. *A1* IS DEFINED AS THE VERTICAL DISTANCE FROM THE SEATING PLANE TO THE LOWEST POINT ON THE PACKAGE BODY.

⌀ 0.08 (0.003) M C B S A S

DIM	MILLIMETERS		
	MIN.	NOM.	MAX.
A	---	---	1.10
A1	0.05	0.08	0.15
<i>b</i>	0.25	0.33	0.40
<i>c</i>	0.13	0.18	0.23
<i>D</i>	2.90	3.00	3.10
<i>E</i>	2.90	3.00	3.10
<i>e</i>	0.65 BSC		
<i>H_E</i>	4.75	4.90	5.05
<i>L</i>	0.40	0.55	0.70

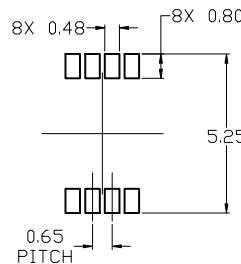

RECOMMENDED MOUNTING FOOTPRINT

For additional information on our Pb-Free strategy and soldering details, please download the ON Semiconductor Soldering and Mounting Techniques Reference Manual, SOLDERM/D.

GENERIC MARKING DIAGRAM*

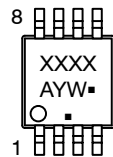

- XXXX = Specific Device Code
- A = Assembly Location
- Y = Year
- W = Work Week
- = Pb-Free Package

(Note: Microdot may be in either location)

*This information is generic. Please refer to device data sheet for actual part marking. Pb-Free indicator, "G" or microdot "▪", may or may not be present. Some products may not follow the Generic Marking.

STYLE 1:

1. SOURCE
2. SOURCE
3. SOURCE
4. GATE
5. DRAIN
6. DRAIN
7. DRAIN
8. DRAIN

STYLE 2:

1. SOURCE 1
2. GATE 1
3. SOURCE 2
4. GATE 2
5. DRAIN 2
6. DRAIN 2
7. DRAIN 1
8. DRAIN 1

STYLE 3:

1. N-SOURCE
2. N-GATE
3. P-SOURCE
4. P-GATE
5. P-DRAIN
6. P-DRAIN
7. N-DRAIN
8. N-DRAIN

DOCUMENT NUMBER:	98ASB14087C	Electronic versions are uncontrolled except when accessed directly from the Document Repository. Printed versions are uncontrolled except when stamped "CONTROLLED COPY" in red.
DESCRIPTION:	MICRO8	PAGE 1 OF 1

ON Semiconductor and ON are trademarks of Semiconductor Components Industries, LLC dba ON Semiconductor or its subsidiaries in the United States and/or other countries. ON Semiconductor reserves the right to make changes without further notice to any products herein. ON Semiconductor makes no warranty, representation or guarantee regarding the suitability of its products for any particular purpose, nor does ON Semiconductor assume any liability arising out of the application or use of any product or circuit, and specifically disclaims any and all liability, including without limitation special, consequential or incidental damages. ON Semiconductor does not convey any license under its patent rights nor the rights of others.

onsemi, **Onsemi**, and other names, marks, and brands are registered and/or common law trademarks of Semiconductor Components Industries, LLC dba "**onsemi**" or its affiliates and/or subsidiaries in the United States and/or other countries. **onsemi** owns the rights to a number of patents, trademarks, copyrights, trade secrets, and other intellectual property. A listing of **onsemi**'s product/patent coverage may be accessed at www.onsemi.com/site/pdf/Patent-Marking.pdf. **onsemi** reserves the right to make changes at any time to any products or information herein, without notice. The information herein is provided "as-is" and **onsemi** makes no warranty, representation or guarantee regarding the accuracy of the information, product features, availability, functionality, or suitability of its products for any particular purpose, nor does **onsemi** assume any liability arising out of the application or use of any product or circuit, and specifically disclaims any and all liability, including without limitation special, consequential or incidental damages. Buyer is responsible for its products and applications using **onsemi** products, including compliance with all laws, regulations and safety requirements or standards, regardless of any support or applications information provided by **onsemi**. "Typical" parameters which may be provided in **onsemi** data sheets and/or specifications can and do vary in different applications and actual performance may vary over time. All operating parameters, including "Typicals" must be validated for each customer application by customer's technical experts. **onsemi** does not convey any license under any of its intellectual property rights nor the rights of others. **onsemi** products are not designed, intended, or authorized for use as a critical component in life support systems or any FDA Class 3 medical devices or medical devices with a same or similar classification in a foreign jurisdiction or any devices intended for implantation in the human body. Should Buyer purchase or use **onsemi** products for any such unintended or unauthorized application, Buyer shall indemnify and hold **onsemi** and its officers, employees, subsidiaries, affiliates, and distributors harmless against all claims, costs, damages, and expenses, and reasonable attorney fees arising out of, directly or indirectly, any claim of personal injury or death associated with such unintended or unauthorized use, even if such claim alleges that **onsemi** was negligent regarding the design or manufacture of the part. **onsemi** is an Equal Opportunity/Affirmative Action Employer. This literature is subject to all applicable copyright laws and is not for resale in any manner.

PUBLICATION ORDERING INFORMATION

LITERATURE FULFILLMENT:

Email Requests to: orderlit@onsemi.com

onsemi Website: www.onsemi.com

TECHNICAL SUPPORT

North American Technical Support:

Voice Mail: 1 800-282-9855 Toll Free USA/Canada

Phone: 011 421 33 790 2910

Europe, Middle East and Africa Technical Support:

Phone: 00421 33 790 2910

For additional information, please contact your local Sales Representative