

# Synchronous Regulator, TINYBOOST<sup>®</sup>, 3 MHz

## FAN4860

### Description

The FAN4860 is a low-power boost regulator designed to provide a regulated 3.3 V, 5.0 V or 5.4 V output from a single cell Lithium or Li-Ion battery. Output voltage options are fixed at 3.3 V, 5.0 V, or 5.4 V with a guaranteed maximum load current of 200 mA at  $V_{IN} = 2.3$  V and 300 mA at  $V_{IN} = 3.3$  V. Input current in Shutdown Mode is less than 1  $\mu$ A, which maximizes battery life.

Light-load PFM operation is automatic and “glitch-free”. The regulator maintains output regulation at no-load with as low as 37  $\mu$ A quiescent current.

The combination of built-in power transistors, synchronous rectification, and low supply current make the FAN4860 ideal for battery powered applications.

The FAN4860 is available in 6-bump 0.4 mm pitch Wafer-Level Chip Scale Package (WLCSP) and a 6-lead 2 x 2 mm ultra-thin MLP package.

### Features

- Operates with Few External Components:  
1  $\mu$ H Inductor and 0402 Case Size Input and Output Capacitors
- Input Voltage Range from 2.3 V to 5.4 V
- Fixed 3.3 V, 5.0 V, or 5.4 V Output Voltage Options
- Maximum Load Current >150 mA at  $V_{IN} = 2.3$  V
- Maximum Load Current 300 mA at  $V_{IN} = 3.3$  V,  $V_{OUT} = 5.4$  V
- Maximum Load Current 300 mA at  $V_{IN} = 3.3$  V,  $V_{OUT} = 5.0$  V
- Maximum Load Current 300 mA at  $V_{IN} = 2.7$  V,  $V_{OUT} = 3.3$  V
- Up to 92% Efficient
- Low Operating Quiescent Current
- True Load Disconnect During Shutdown
- Variable On-time Pulse Frequency Modulation (PFM) with Light-Load Power-Saving Mode
- Internal Synchronous Rectifier (No External Diode Needed)
- Thermal Shutdown and Overload Protection
- 6-Pin 2 x 2 mm UMLP
- 6-Bump WLCSP, 0.4 mm Pitch

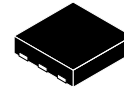
### Applications

- USB “On the Go” 5 V Supply
- 5 V Supply – HDMI, H-Bridge Motor Drivers
- Powering 3.3 V Core Rails
- PDAs, Portable Media Players
- Cell Phones, Smart Phones, Portable Instruments



ON Semiconductor<sup>®</sup>

[www.onsemi.com](http://www.onsemi.com)



UDFN6 2 x 2, 0.65P  
CASE 517DS

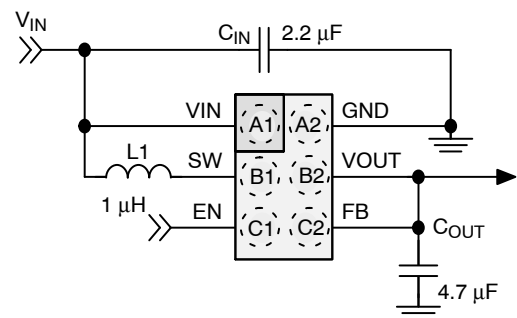


WLCSP6 1.23 x 0.88 x 0.586  
CASE 567RP

### ORDERING INFORMATION

See detailed ordering and shipping information on page 2 of this data sheet.

### TYPICAL APPLICATION



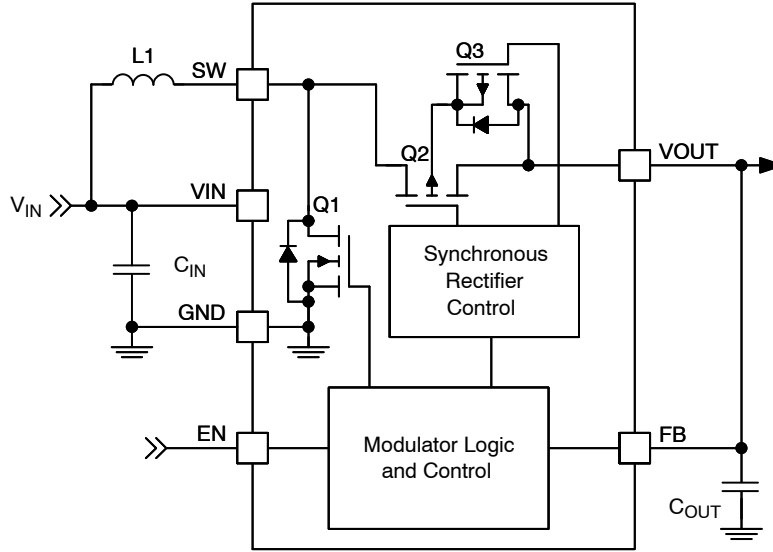
# FAN4860

**Table 1. ORDERING INFORMATION**

Part Number	Operating Temperature Range	Package	Packing Method
FAN4860UC5X	-40°C to 85°C	WLCSP, 0.4 mm Pitch	Tape and Reel
FAN4860UMP5X	-40°C to 85°C	UMLP-6, 2 x 2 mm	Tape and Reel
FAN4860UC33X*	-40°C to 85°C	WLCSP, 0.4 mm Pitch	Tape and Reel
FAN4860UC54X*	-40°C to 85°C	WLCSP, 0.4 mm Pitch	Tape and Reel

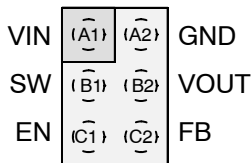
\*This device is End of Life. Please contact sales for additional information and assistance with replacement devices.

## BLOCK DIAGRAMS

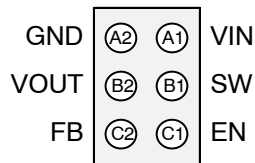


**Figure 1. IC Block Diagram**

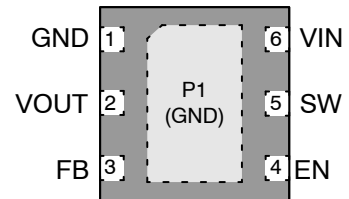
## PIN CONFIGURATIONS



**Figure 2. WLCSP (Top View)**



**Figure 3. WLCSP (Bottom View)**



**Figure 4. 2x2 mm UMLP (Top View)**

# FAN4860

**Table 2. PIN DEFINITIONS**

Pin #		Name	Description
WLCSP	UMLP		
A1	6	VIN	Input Voltage. Connect to Li-Ion battery input power source and input capacitor (C <sub>IN</sub> )
B1	5	SW	Switching Node. Connect to inductor
C1	4	EN	Enable. When this pin is HIGH, the circuit is enabled. This pin should not be left floating
C2	3	FB	Feedback. Output voltage sense point for V <sub>OUT</sub> . Connect to output capacitor (C <sub>OUT</sub> )
B2	2	VOUT	Output Voltage. This pin is both the output voltage terminal as well as an IC bias supply
A2	1, P1	GND	Ground. Power and signal ground reference for the IC. All voltages are measured with respect to this pin

**Table 3. ABSOLUTE MAXIMUM RATINGS**

Symbol	Parameter		Min.	Max.	Units
V <sub>IN</sub>	VIN Pin		-0.3	5.5	V
V <sub>OUT</sub>	VOUT Pin		-2	6	V
V <sub>FB</sub>	FB Pin		-2	6	V
V <sub>SW</sub>	SW Node	DC	-0.3	5.5	V
		Transient: 10 ns, 3 MHz	-1.0	6.5	
V <sub>EN</sub>	EN Pin		-0.3	5.5	V
ESD	Electrostatic Discharge Protection Level	Human Body Model per JESD22-A114	2		kV
		Charged Device Model per JESD22-C101	1		
T <sub>J</sub>	Junction Temperature		-40	+150	°C
T <sub>STG</sub>	Storage Temperature		-65	+150	°C
T <sub>L</sub>	Lead Soldering Temperature, 10 Seconds			+260	°C

Stresses exceeding those listed in the Maximum Ratings table may damage the device. If any of these limits are exceeded, device functionality should not be assumed, damage may occur and reliability may be affected.

**Table 4. RECOMMENDED OPERATING CONDITIONS**

Symbol	Parameter		Min.	Max.	Units
V <sub>IN</sub>	Supply Voltage	5.4 V <sub>OUT</sub>	2.3	4.5	V
		5.0 V <sub>OUT</sub>	2.3	4.5	
		3.3 V <sub>OUT</sub>	2.5	3.2	
I <sub>OUT</sub>	Output Current			200	mA
T <sub>A</sub>	Ambient Temperature		-40	+85	°C
T <sub>J</sub>	Junction Temperature		-40	+125	°C

Functional operation above the stresses listed in the Recommended Operating Ranges is not implied. Extended exposure to stresses beyond the Recommended Operating Ranges limits may affect device reliability.

# FAN4860

**Table 5. THERMAL PROPERTIES**

Symbol	Parameter	Typical	Units
$\theta_{JA}$	Junction-to-Ambient Thermal Resistance	WLCSP	130
		UMLP	57

1. Junction-to-ambient thermal resistance is a function of application and board layout. This data is measured with four-layer 2s2p boards in accordance to JEDEC standard JESD51. Special attention must be paid not to exceed junction temperature  $T_{J(max)}$  at a given ambient temperature  $T_A$ .

**Table 6. ELECTRICAL SPECIFICATIONS**

(Minimum and maximum values are at  $V_{IN} = V_{EN} = 2.3\text{ V}$  to  $4.5\text{ V}$  ( $2.5$  to  $3.2\text{ V}_{IN}$  for  $3.3\text{ V}_{OUT}$  option),  $T_A = -40^\circ\text{C}$  to  $+85^\circ\text{C}$ ; circuit of Typical Application, unless otherwise noted. Typical values are at  $T_A = 25^\circ\text{C}$ ,  $V_{IN} = V_{EN} = 3.6\text{ V}$  for  $V_{OUT} = 5.0\text{ V} / 5.4\text{ V}$ , and  $V_{IN} = V_{EN} = 2.7\text{ V}$  for  $V_{OUT} = 3.3\text{ V}$ )

Symbol	Parameter	Conditions	Min	Typ	Max	Units	
$I_{IN}$	$V_{IN}$ Input Current	5.4 $V_{OUT}$	Quiescent: $V_{IN} = 3.6\text{ V}$ , $I_{OUT} = 0$ , $EN = V_{IN}$		37	45	$\mu\text{A}$
			Shutdown: $EN = 0$ , $V_{IN} = 3.6\text{ V}$		0.5	1.5	$\mu\text{A}$
		5.0 $V_{OUT}$	Quiescent: $V_{IN} = 3.6\text{ V}$ , $I_{OUT} = 0$ , $EN = V_{IN}$		37	45	
			Shutdown: $EN = 0$ , $V_{IN} = 3.6\text{ V}$		0.5	1.5	
		3.3 $V_{OUT}$	Quiescent: $V_{IN} = 2.7\text{ V}$ , $I_{OUT} = 0$ , $EN = V_{IN}$		50	65	
			Shutdown: $EN = 0$ , $V_{IN} = 2.7\text{ V}$		0.5	1.5	
$I_{LK\_OUT}$	$V_{OUT}$ Leakage Current	$V_{OUT} = 0$ , $EN = 0$ , $V_{IN} \geq 3\text{ V}$		10		nA	
$I_{LK\_RVSR}$	$V_{OUT}$ to $V_{IN}$ Reverse Leakage	$V_{OUT} = 5.4\text{ V}$ , $V_{IN} = 3.6\text{ V}$ , $EN = 0$			2.5	$\mu\text{A}$	
		$V_{OUT} = 5.0\text{ V}$ , $V_{IN} = 3.6\text{ V}$ , $EN = 0$					
		$V_{OUT} = 3.3\text{ V}$ , $V_{IN} = 3.0\text{ V}$ , $EN = 0$					
$V_{UVLO}$	Under-Voltage Lockout	$V_{IN}$ Rising		2.2	2.3	V	
$V_{UVLO\_HYS}$	Under-Voltage Lockout Hysteresis			190		mV	
$V_{ENH}$	Enable HIGH Voltage		1.05			V	
$V_{ENL}$	Enable LOW Voltage				0.4	V	
$I_{LK\_EN}$	Enable Input Leakage Current			0.01	1.00	$\mu\text{A}$	
$V_{OUT}$	Output Voltage Accuracy (Note 2)	$V_{IN}$ from 2.3 V to 4.5 V, $I_{OUT} \leq 200\text{ mA}$	5.15	5.40	5.50	V	
		$V_{IN}$ from 2.7 V to 4.5 V, $I_{OUT} \leq 200\text{ mA}$	5.20	5.40	5.50		
		$V_{IN}$ from 3.3 V to 4.5 V, $I_{OUT} \leq 300\text{ mA}$	5.15	5.40	5.50		
		$V_{IN}$ from 2.3 V to 4.5 V, $I_{OUT} \leq 200\text{ mA}$	4.80	5.05	5.15		
		$V_{IN}$ from 2.7 V to 4.5 V, $I_{OUT} \leq 200\text{ mA}$	4.85	5.05	5.15		
		$V_{IN}$ from 3.3 V to 4.5 V, $I_{OUT} \leq 300\text{ mA}$	4.85	5.05	5.15		
		$V_{IN}$ from 2.5 V to 3.2 V, $I_{OUT} \leq 200\text{ mA}$	3.17	3.33	3.41		
$V_{ref}$	Reference Accuracy	Referred to $V_{OUT} = 5.4\text{ V}$	5.325	5.400	5.475	V	
		Referred to $V_{OUT} = 5.0\text{ V}$	4.975	5.050	5.125		
		Referred to $V_{OUT} = 3.3\text{ V}$	3.280	3.330	3.380		
$t_{OFF}$	Off Time	$V_{IN} = 3.6\text{ V}$ , $V_{OUT} = 5.4\text{ V}$ , $I_{OUT} = 200\text{ mA}$	185	230	255	ns	
		$V_{IN} = 3.6\text{ V}$ , $V_{OUT} = 5.0\text{ V}$ , $I_{OUT} = 200\text{ mA}$	195	240	265		
		$V_{IN} = 2.7\text{ V}$ , $V_{OUT} = 3.3\text{ V}$ , $I_{OUT} = 200\text{ mA}$	240	290	350		

# FAN4860

**Table 6. ELECTRICAL SPECIFICATIONS** (continued)

(Minimum and maximum values are at  $V_{IN} = V_{EN} = 2.3\text{ V}$  to  $4.5\text{ V}$  ( $2.5$  to  $3.2\text{ V}_{IN}$  for  $3.3\text{ V}_{OUT}$  option),  $T_A = -40^\circ\text{C}$  to  $+85^\circ\text{C}$ ; circuit of Typical Application, unless otherwise noted. Typical values are at  $T_A = 25^\circ\text{C}$ ,  $V_{IN} = V_{EN} = 3.6\text{ V}$  for  $V_{OUT} = 5.0\text{ V} / 5.4\text{ V}$ , and  $V_{IN} = V_{EN} = 2.7\text{ V}$  for  $V_{OUT} = 3.3\text{ V}$ )

Symbol	Parameter	Conditions	Min	Typ	Max	Units	
$I_{OUT}$	Maximum Output Current (Note 2)	5.4 $V_{OUT}$	$V_{IN} = 2.3\text{ V}$	200			mA
			$V_{IN} = 3.3\text{ V}$	300			
			$V_{IN} = 3.6\text{ V}$		400		
		5.0 $V_{OUT}$	$V_{IN} = 2.3\text{ V}$	200			
			$V_{IN} = 3.3\text{ V}$	300			
			$V_{IN} = 3.6\text{ V}$		400		
		3.3 $V_{OUT}$	$V_{IN} = 2.5\text{ V}$	250			
$V_{IN} = 2.7\text{ V}$			300				
$I_{SW}$		SW Peak Current Limit	5.4 $V_{OUT}$	$V_{IN} = 3.6\text{ V}, V_{OUT} > V_{IN}$	1000	1400	
	5.0 $V_{OUT}$		$V_{IN} = 3.6\text{ V}, V_{OUT} > V_{IN}$	930	1100	1320	
	3.3 $V_{OUT}$		$V_{IN} = 2.7\text{ V}, V_{OUT} > V_{IN}$	650	800	950	
$I_{SS}$	Soft-Start Input Peak Current Limit (Note 3)	5.4 $V_{OUT}$	$V_{IN} = 3.6\text{ V}, V_{OUT} < V_{IN}$		900		mA
		5.0 $V_{OUT}$	$V_{IN} = 3.6\text{ V}, V_{OUT} < V_{IN}$		850		
		3.3 $V_{OUT}$	$V_{IN} = 2.7\text{ V}, V_{OUT} < V_{IN}$		700		
$t_{SS}$	Soft-Start Time (Note 4)	5.4 $V_{OUT}$	$V_{IN} = 3.6\text{ V}, I_{OUT} = 200\text{ mA}$		270	400	$\mu\text{s}$
		5.0 $V_{OUT}$	$V_{IN} = 3.6\text{ V}, I_{OUT} = 200\text{ mA}$		100	300	
		3.3 $V_{OUT}$	$V_{IN} = 2.7\text{ V}, I_{OUT} = 200\text{ mA}$		250	750	
$R_{DS(ON)}$	N-Channel Boost Switch	$V_{IN} = 3.6\text{ V}$		300		m $\Omega$	
	P-Channel Sync Rectifier	$V_{IN} = 3.6\text{ V}$		400			
$T_{TSD}$	Thermal Shutdown	$I_{LOAD} = 10\text{ mA}$		150		$^\circ\text{C}$	
$T_{TSD\_HYS}$	Thermal Shutdown Hysteresis			30		$^\circ\text{C}$	

2.  $I_{LOAD}$  from 0 to  $I_{OUT}$ ; also includes load transient response.  $V_{OUT}$  measured from mid-point of output voltage ripple.

Effective capacitance of  $C_{OUT} > 1.5\text{ }\mu\text{F}$ .

3. Guaranteed by design and characterization; not tested in production.

4. Elapsed time from rising EN until regulated  $V_{OUT}$ .

5.4 V<sub>OUT</sub> TYPICAL CHARACTERISTICS

Unless otherwise specified; circuit per Typical Application, 3.6 V<sub>IN</sub>, and T<sub>A</sub> = 25°C.

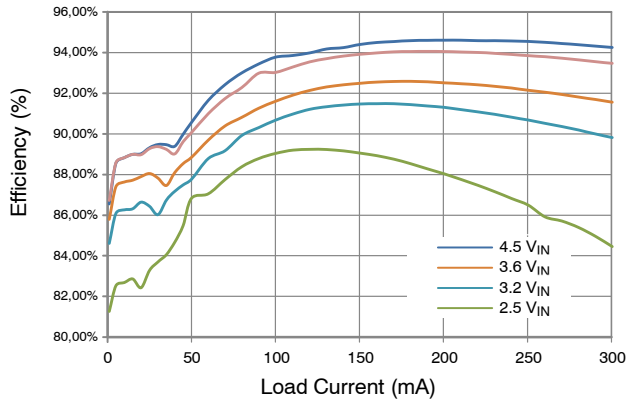


Figure 5. Efficiency vs. V<sub>IN</sub>

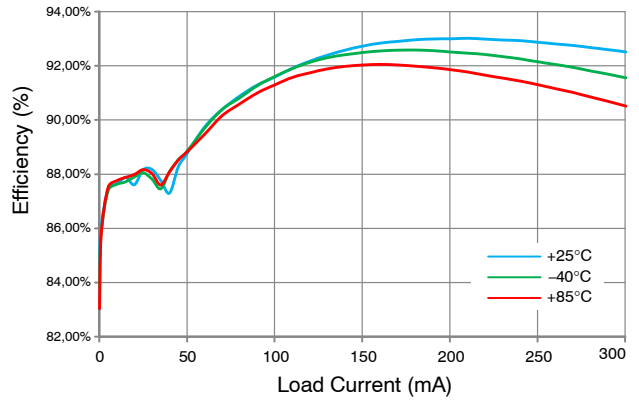


Figure 6. Efficiency vs. Temperature, 3.6 V<sub>IN</sub>

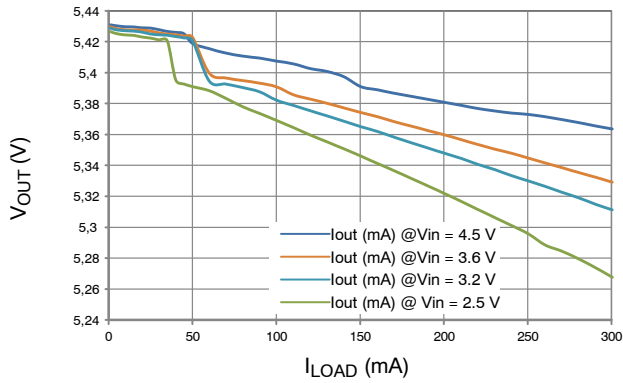


Figure 7. Line and Load Regulation

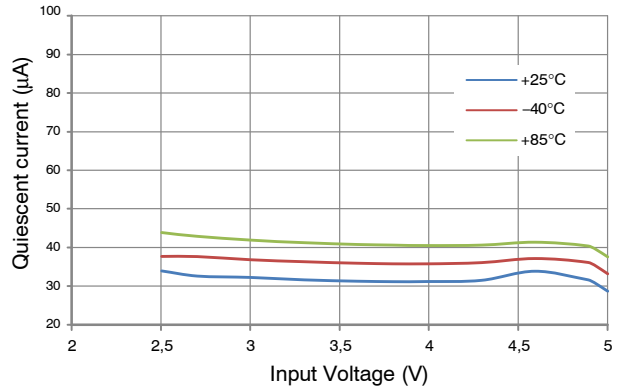


Figure 8. Quiescent Current

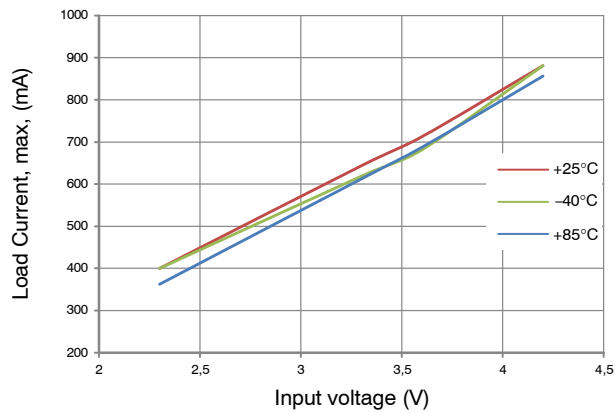


Figure 9. Maximum DC Load Current

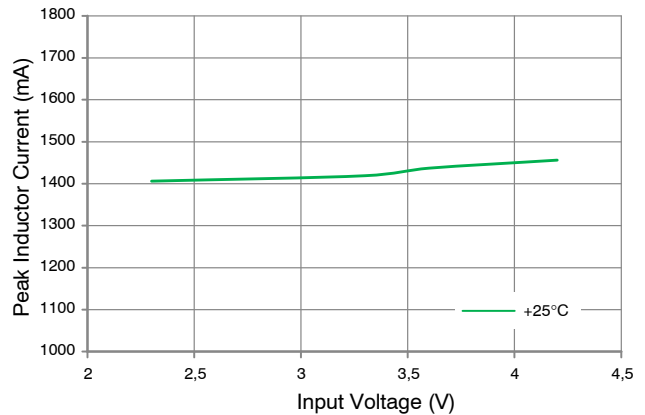


Figure 10. Peak Inductor Current

**5.4 V<sub>OUT</sub> TYPICAL CHARACTERISTICS** (continued)

Unless otherwise specified; circuit per Typical Application, 3.6 V<sub>IN</sub>, and T<sub>A</sub>=25°C.

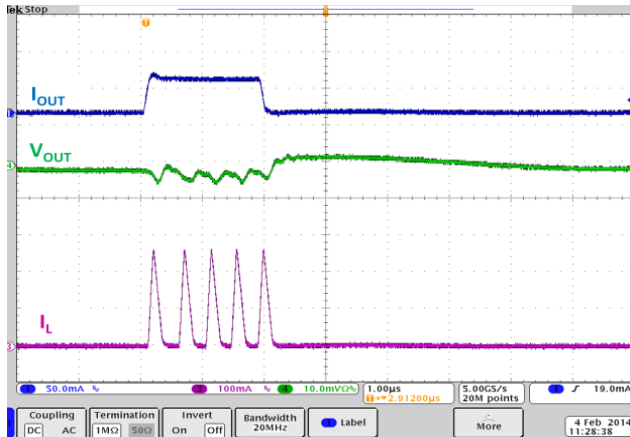


Figure 11. 0–50 mA Load Transient, 100 ns Step

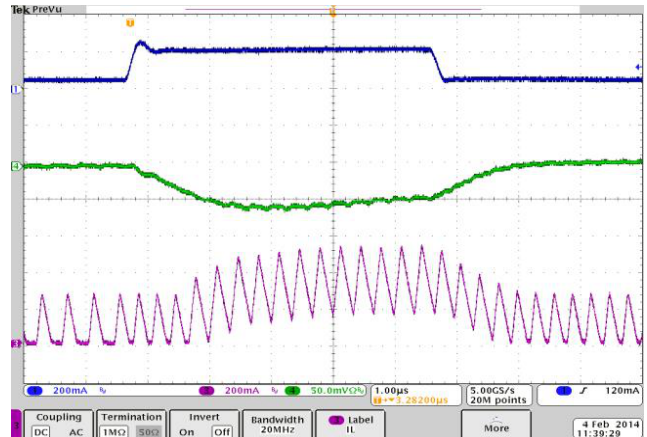


Figure 12. 50–200 mA Load Transient, 100 ns Step

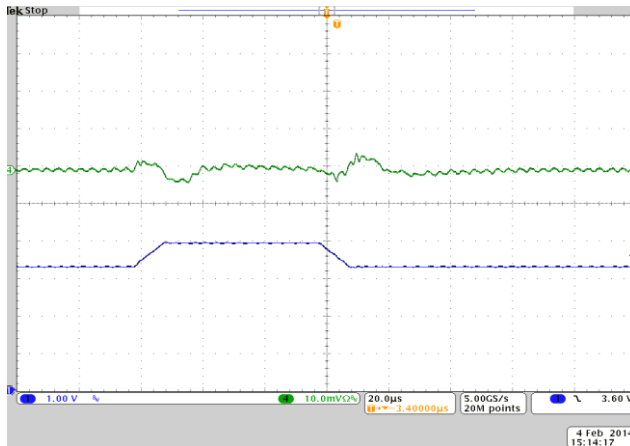


Figure 13. Line Transient, 5 mA Load, 10 μs Step



Figure 14. Line Transient, 200 mA Load, 10 μs Step

**5.0 V<sub>OUT</sub> TYPICAL CHARACTERISTICS**

Unless otherwise specified; circuit per Typical Application, 3.6 V<sub>IN</sub>, and T<sub>A</sub> = 25°C.

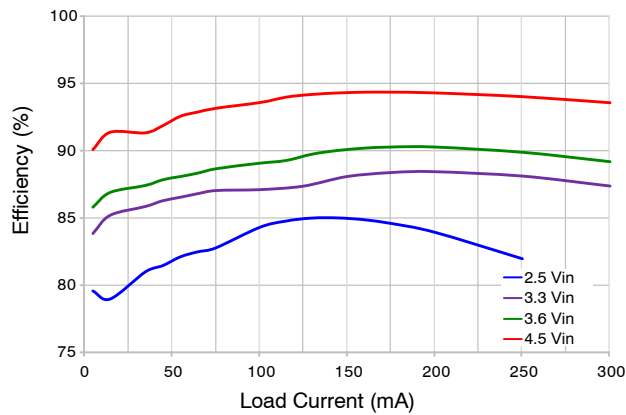


Figure 15. Efficiency vs. V<sub>IN</sub>

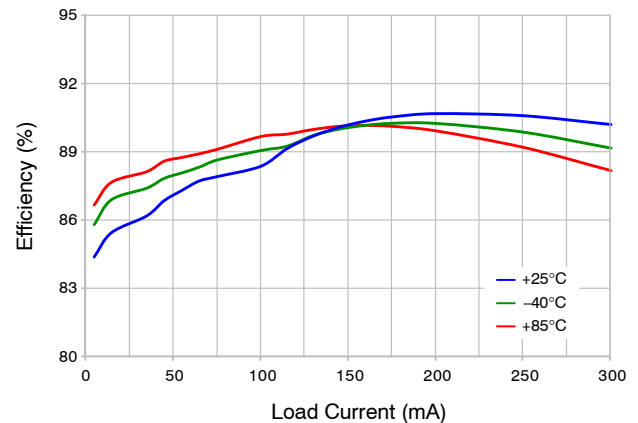


Figure 16. Efficiency vs. Temperature, 3.6 V<sub>IN</sub>

5.0 V<sub>OUT</sub> TYPICAL CHARACTERISTICS (continued)

Unless otherwise specified; circuit per Typical Application, 3.6 V<sub>IN</sub>, and T<sub>A</sub> = 25°C.

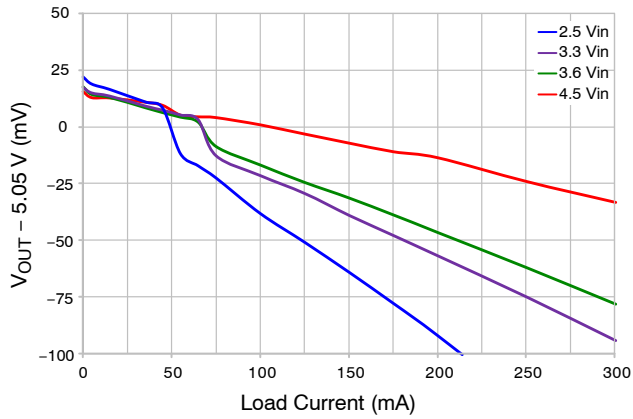


Figure 17. Line and Load Regulation

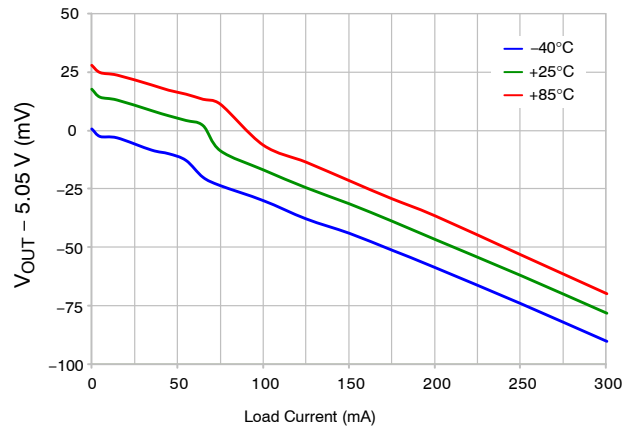


Figure 18. Load Regulation vs. Temperature, 3.6 V<sub>IN</sub>

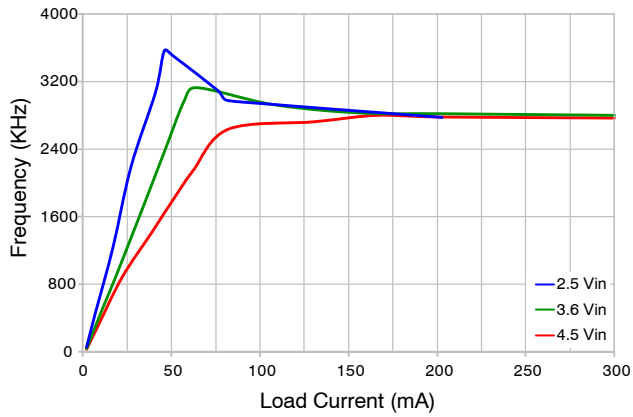


Figure 19. Switching Frequency

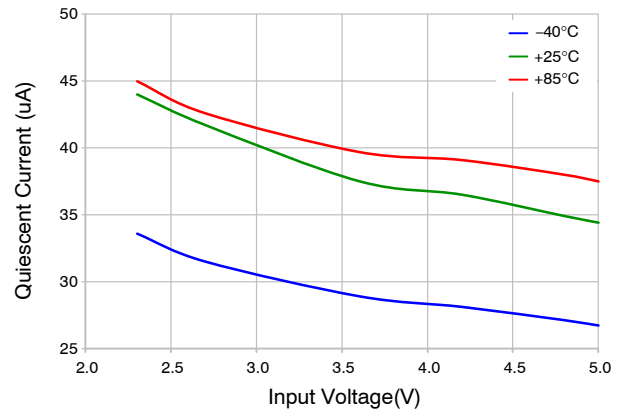


Figure 20. Quiescent Current

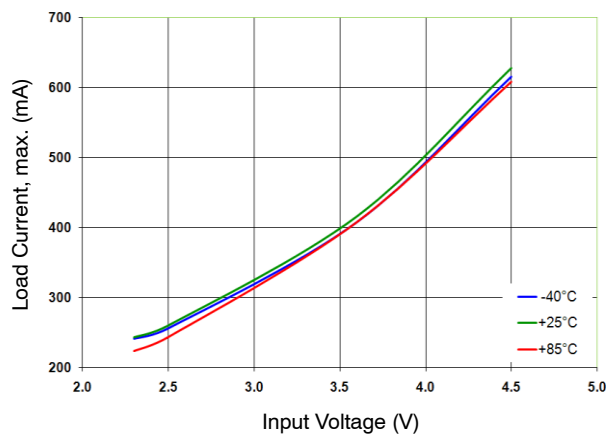


Figure 21. Maximum DC Load Current

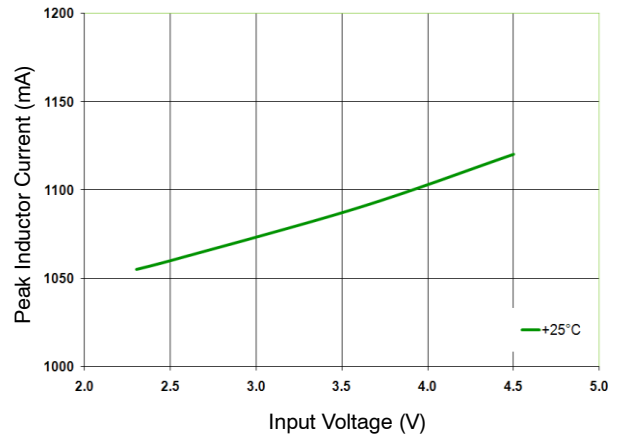


Figure 22. Peak Inductor Current



5.0 V<sub>OUT</sub> TYPICAL CHARACTERISTICS (continued)

Unless otherwise specified; circuit per Typical Application, 3.6 V<sub>IN</sub>, and T<sub>A</sub> = 25°C.

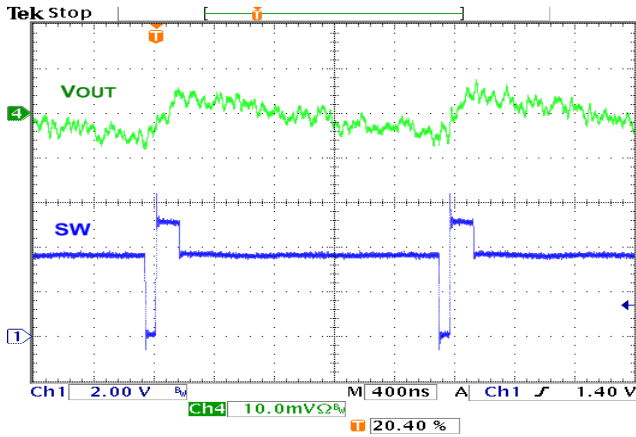


Figure 23. Output Ripple, 10 mA PFM Load

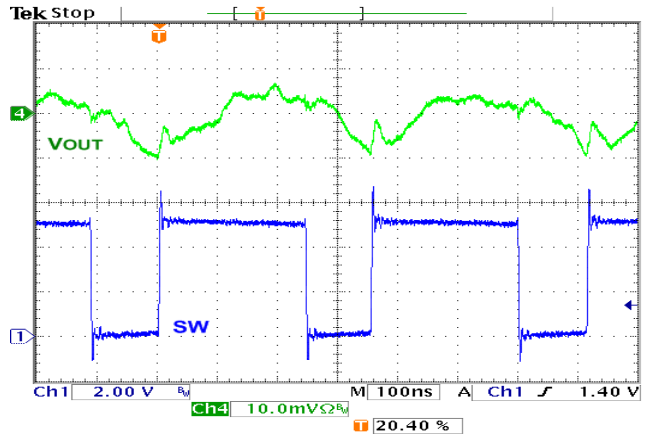


Figure 24. Output Ripple, 200 mA PWM Load

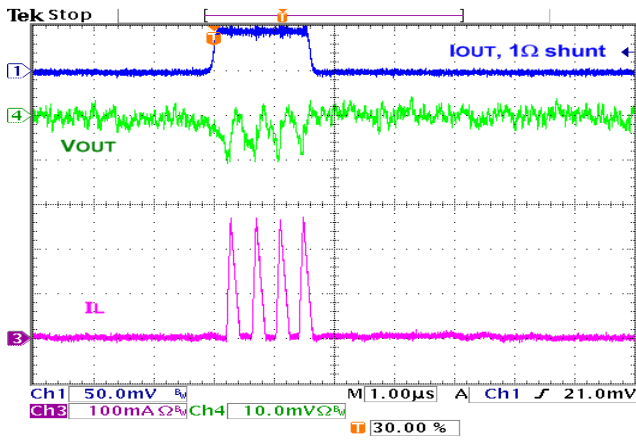


Figure 25. 0–50 mA Load Transient, 100 ns Step

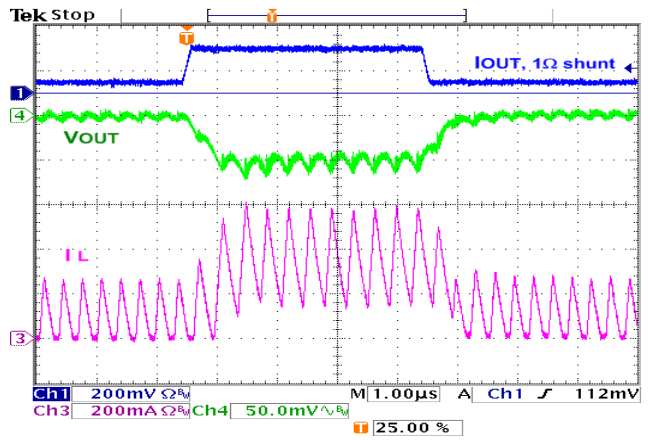


Figure 26. 50–200 mA Load Transient, 100 ns Step

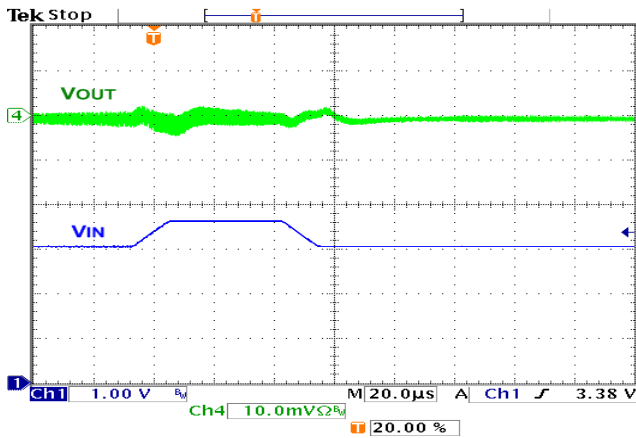


Figure 27. Line Transient, 5 mA Load, 10 μs Step

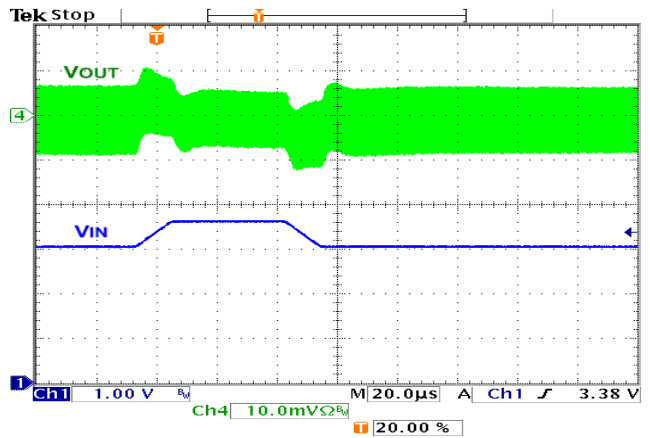


Figure 28. Line Transient, 200 mA Load, 10 μs Step

# FAN4860

## 5.0 V<sub>OUT</sub> TYPICAL CHARACTERISTICS (continued)

Unless otherwise specified; circuit per Typical Application, 3.6 V<sub>IN</sub>, and T<sub>A</sub> = 25°C.

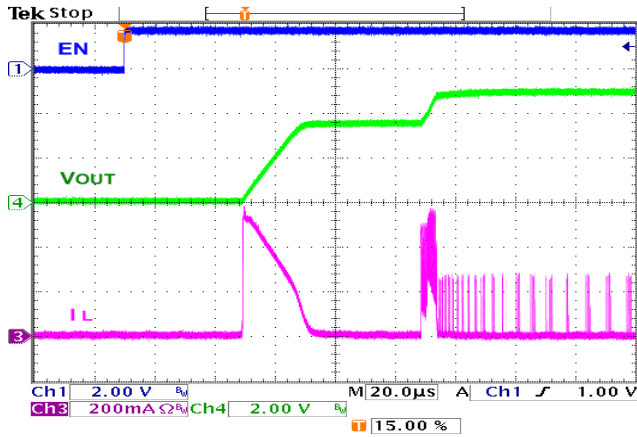


Figure 29. Start Up, No load

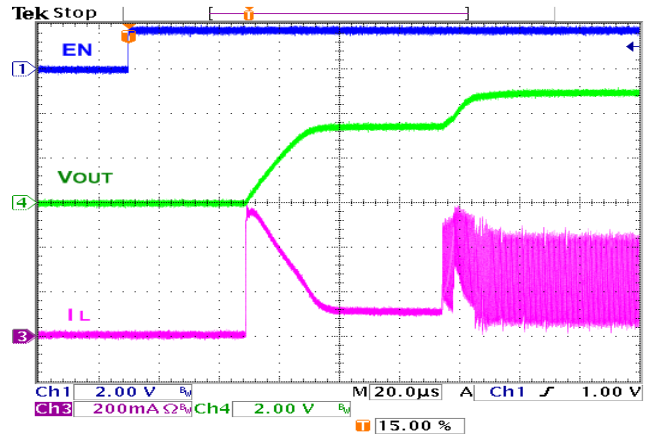


Figure 30. Start Up, 33 Ω Load

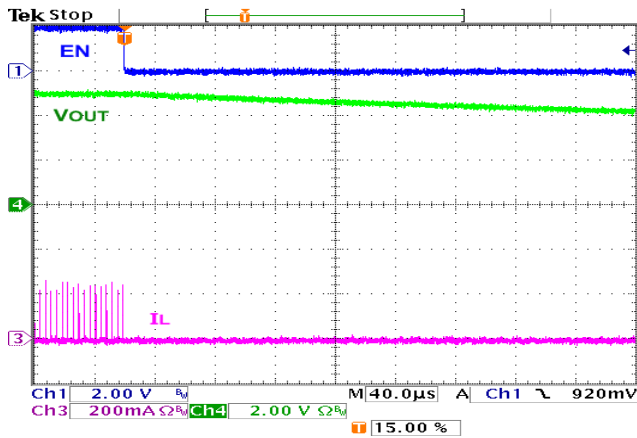


Figure 31. Shutdown, 1 kΩ Load

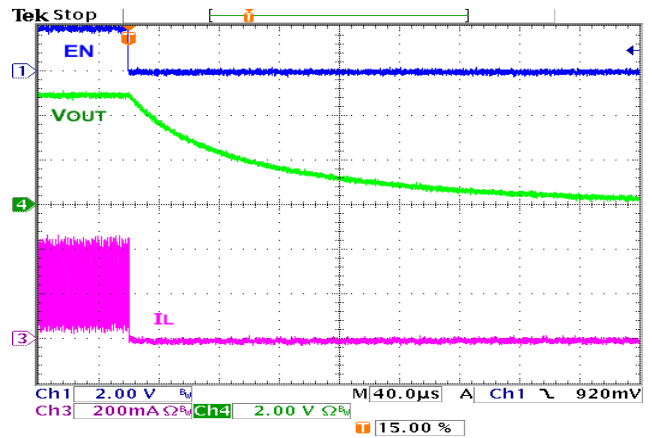


Figure 32. Shutdown, 33 Ω Load

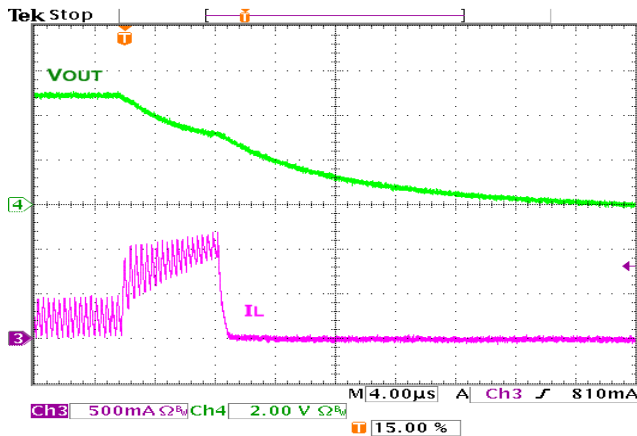


Figure 33. Overload Protection

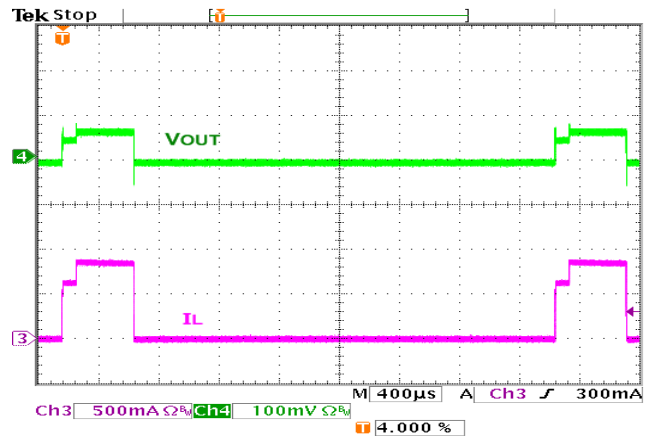


Figure 34. Short-Circuit Response

### 3.3 V<sub>OUT</sub> TYPICAL CHARACTERISTICS

Unless otherwise specified; circuit per Typical Application, 3.0 V<sub>IN</sub>, and T<sub>A</sub> = 25°C.

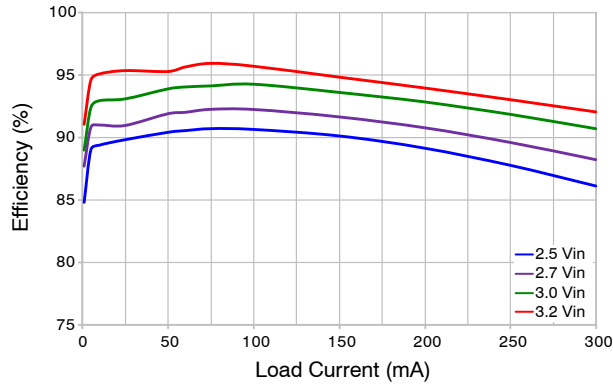


Figure 35. Efficiency vs. V<sub>IN</sub>

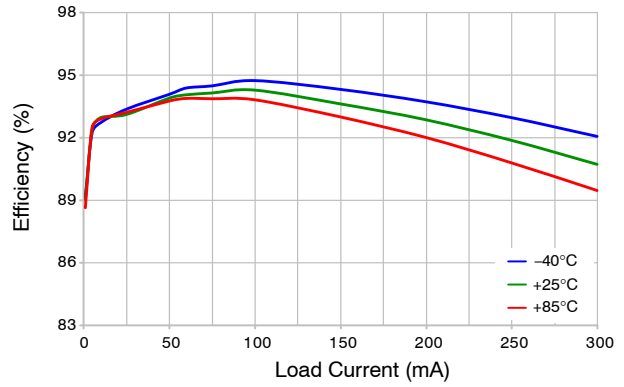


Figure 36. Efficiency vs. Temperature, 3.0 V<sub>IN</sub>

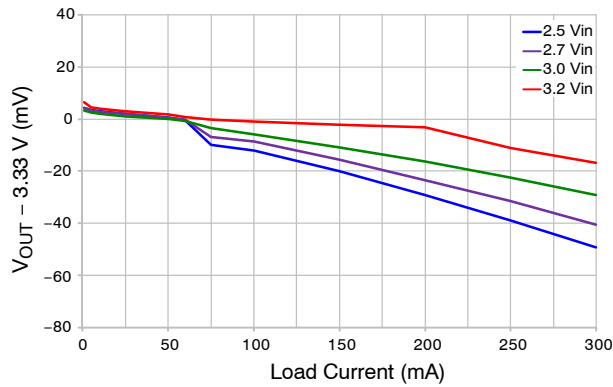


Figure 37. Line and Load Regulation

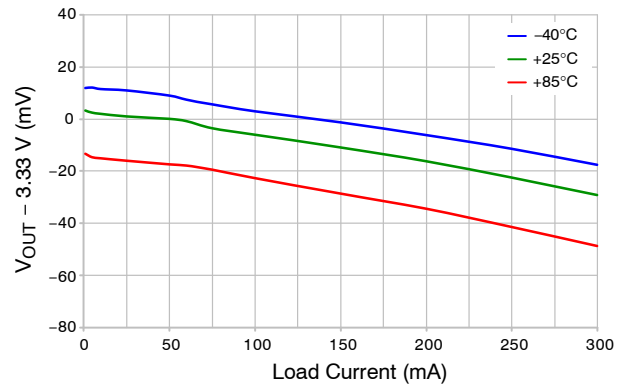


Figure 38. Load Regulation vs. Temperature, 3.0 V<sub>IN</sub>

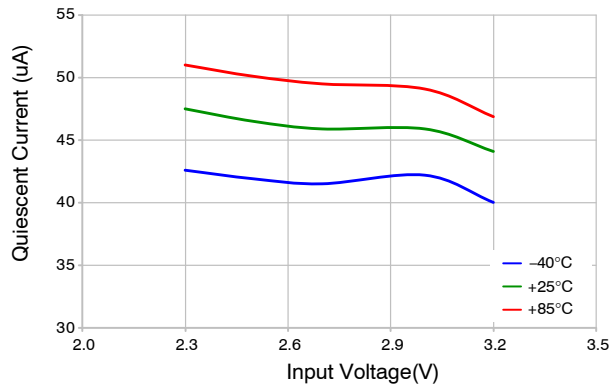


Figure 39. Quiescent Current

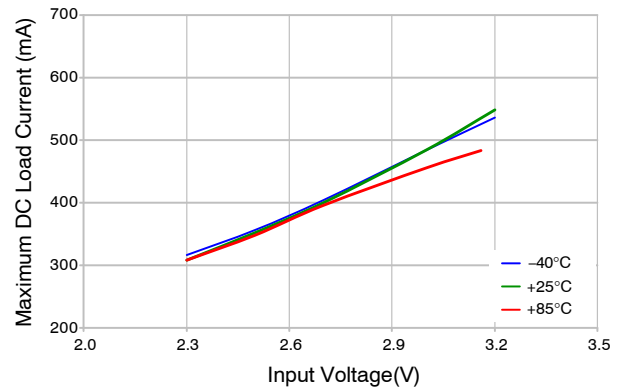


Figure 40. Maximum DC Load Current

3.3 V<sub>OUT</sub> TYPICAL CHARACTERISTICS (continued)

Unless otherwise specified; circuit per Typical Application, 3.0 V<sub>IN</sub>, and T<sub>A</sub> = 25°C.

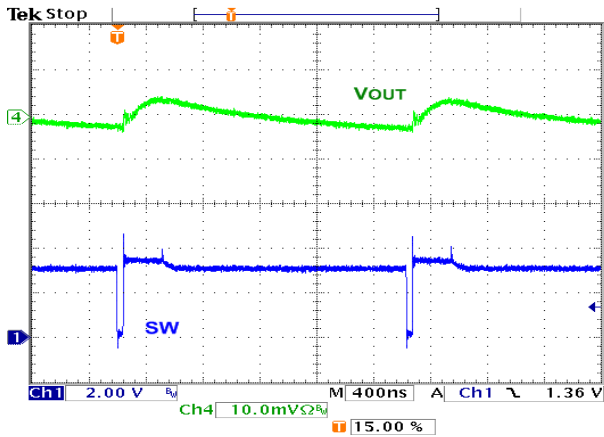


Figure 41. Output Ripple, 10 mA PFM Load

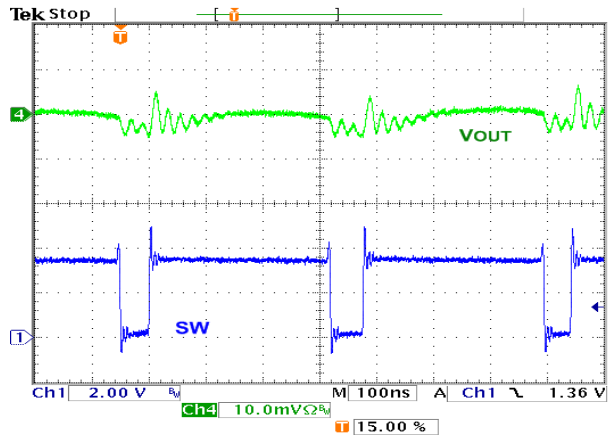


Figure 42. Output Ripple, 200 mA PWM Load

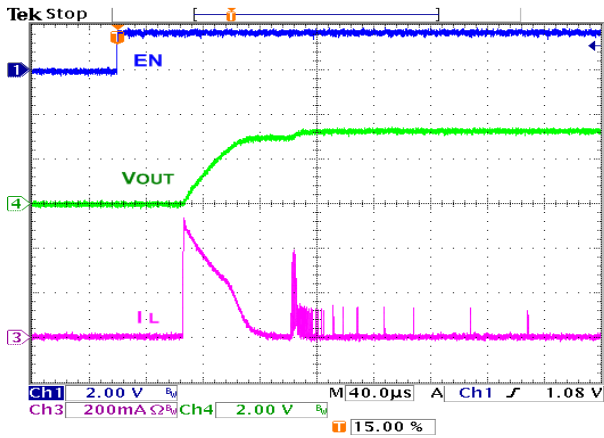


Figure 43. Startup, No Load

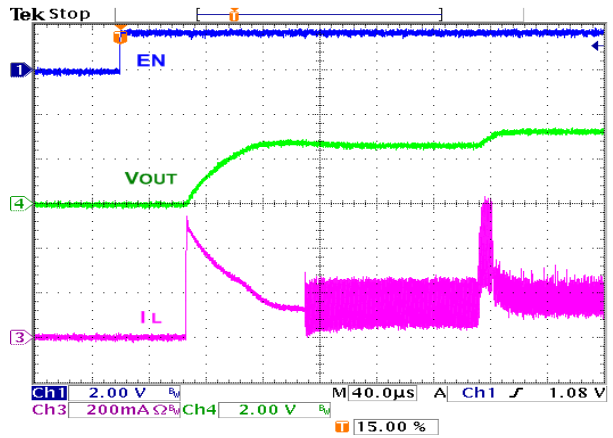


Figure 44. Startup, 22 Ω Load

**FUNCTIONAL DESCRIPTION**

**Circuit Description**

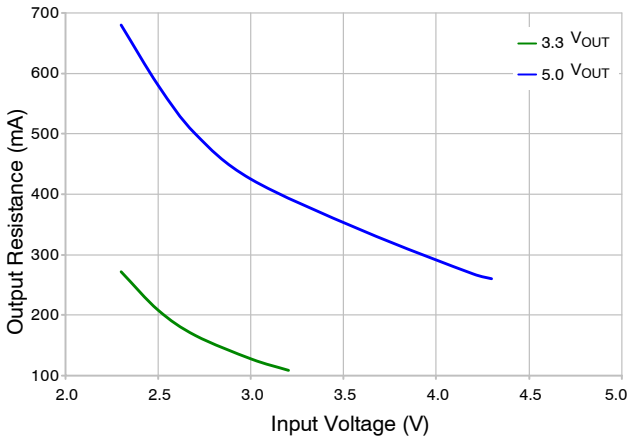
The FAN4860 is a synchronous boost regulator, typically operating at 3 MHz in Continuous Conduction Mode (CCM), which occurs at moderate to heavy load current and low  $V_{IN}$  voltages.

At light-load currents, the converter switches automatically to power-saving PFM Mode. The regulator automatically and smoothly transitions between quasi-fixed-frequency continuous conduction PWM Mode and variable-frequency PFM Mode to maintain the highest possible efficiency over the full range of load current and input voltage.

**PWM Mode Regulation**

The FAN4860 uses a minimum on-time and computed minimum off-time to regulate  $V_{OUT}$ . The regulator achieves excellent transient response by employing current mode modulation. This technique causes the regulator output to exhibit a load line. During PWM Mode, the output voltage drops slightly as the input current rises. With a constant  $V_{IN}$ , this appears as a constant output resistance.

The “droop” caused by the output resistance when a load is applied allows the regulator to respond smoothly to load transients with negligible overshoot.



**Figure 45. Output Resistance ( $R_{OUT}$ )**

When the regulator is in PWM CCM Mode and the target  $V_{OUT} = 5.05$  V,  $V_{OUT}$  is a function of  $I_{LOAD}$  and can be computed as:

$$V_{OUT} = 5.05 - R_{OUT} \times I_{LOAD} \quad (\text{eq. 1})$$

For example, at  $V_{IN} = 3.3$  V, and  $I_{LOAD} = 200$  mA,  $V_{OUT}$  drops to:

$$V_{OUT} = 5.05 - 0.38 \times 0.2 = 4.974 \text{ V} \quad (\text{eq. 2})$$

At  $V_{IN} = 2.3$  V, and  $I_{LOAD} = 200$  mA,  $V_{OUT}$  drops to:

$$V_{OUT} = 5.05 - 0.68 \times 0.2 = 4.914 \text{ V} \quad (\text{eq. 3})$$

**PFM Mode**

If  $V_{OUT} > V_{REF}$  when the minimum off-time has ended, the regulator enters PFM Mode. Boost pulses are inhibited until  $V_{OUT} < V_{REF}$ . The minimum on-time is increased to enable the output to pump up sufficiently with each PFM boost pulse. Therefore, the regulator behaves like a constant on-time regulator, with the bottom of its output voltage ripple at 5.05 V in PFM Mode.

**Table 7. OPERATING STATES**

Mode	Description	Invoked When:
LIN	Linear Startup	$V_{IN} > V_{OUT}$
SS	Boost Soft-Start	$V_{OUT} < V_{REG}$
BST	Boost Operating Mode	$V_{OUT} = V_{REG}$

*Shutdown and Startup*

If EN is LOW, all bias circuits are off and the regulator is in Shutdown Mode. During shutdown, true load disconnect between battery and load prevents current flow from  $V_{IN}$  to  $V_{OUT}$ , as well as reverse flow from  $V_{OUT}$  to  $V_{IN}$ .

*LIN State*

When EN rises, if  $V_{IN} > UVLO$ , the regulator first attempts to bring  $V_{OUT}$  within about 1V of  $V_{IN}$  by using the internal fixed current source from  $V_{IN}$  ( $I_{LIN1}$ ). The current is limited to about 630 mA during LIN1 Mode.

If  $V_{OUT}$  reaches  $V_{IN} - 1$  V during LIN1 Mode, the SS state is initiated. Otherwise, LIN1 times out after 16 clock counts and the LIN2 Mode is entered.

In LIN2 Mode, the current source is incremented to 850 mA. If  $V_{OUT}$  fails to reach  $V_{IN} - 1$  V after 64 clock counts, a fault condition is declared.

*SS State*

Upon the successful completion of the LIN state ( $V_{OUT} \geq V_{IN} - 1$  V), the regulator begins switching with boost pulses current limited to about 50% of nominal level, incrementing to full scale over a period of 32 clock counts.

If the output fails to achieve 90% of its set point within 96 clock counts at full-scale current limit, a fault condition is declared.

*BST State*

This is the normal operating mode of the regulator. The regulator uses a minimum  $t_{OFF}$ -minimum  $t_{ON}$  modulation scheme. Minimum  $t_{OFF}$  is proportional to  $V_{IN} / V_{OUT}$ , which keeps the regulator’s switching frequency reasonably constant in CCM.  $t_{ON(MIN)}$  is proportional to  $V_{IN}$  and is higher if the inductor current reaches 0 before  $t_{OFF(MIN)}$  during the prior cycle.

To ensure that  $V_{OUT}$  does not pump significantly above the regulation point, the boost switch remains off as long as  $FB > V_{REF}$ .

**Fault State**

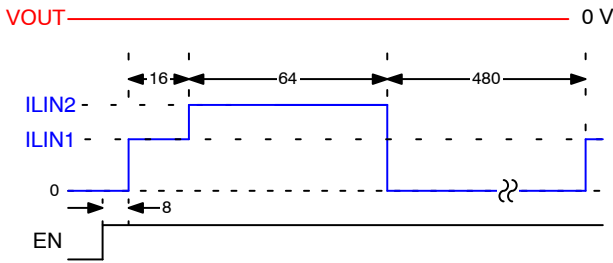
The regulator enters the FAULT state under any of the following conditions:

- $V_{OUT}$  fails to achieve the voltage required to advance from LIN state to SS state
- $V_{OUT}$  fails to achieve the voltage required to advance from SS state to BST state
- Sustained (32 CLK counts) pulse-by-pulse current limit during the BST state
- The regulator moves from BST to LIN state due to a short circuit or output overload ( $V_{OUT} < V_{IN}-1$  V)

Once a fault is triggered, the regulator stops switching and presents a high-impedance path between  $V_{IN}$  and  $V_{OUT}$ . After waiting 480 CLK counts, a restart is attempted.

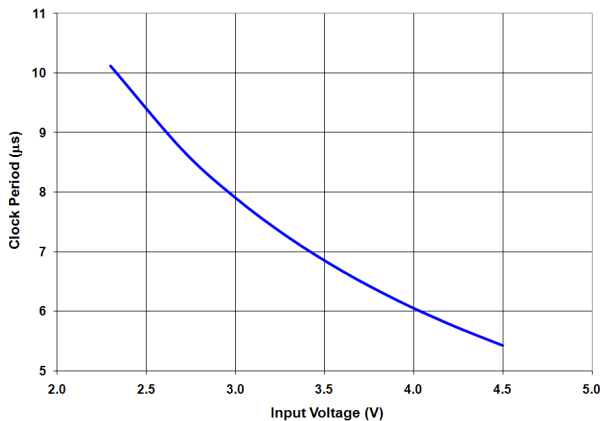
**Soft-Start and Fault Timing**

The soft-start timing for each state, and the fault times, are determined by the fault clock, whose period is inversely proportional to  $V_{IN}$ . This allows the regulator more time to charge larger values of  $C_{OUT}$  when  $V_{IN}$  is lower. With higher  $V_{IN}$ , this also reduces power delivered to  $V_{OUT}$  during each cycle in current limit.



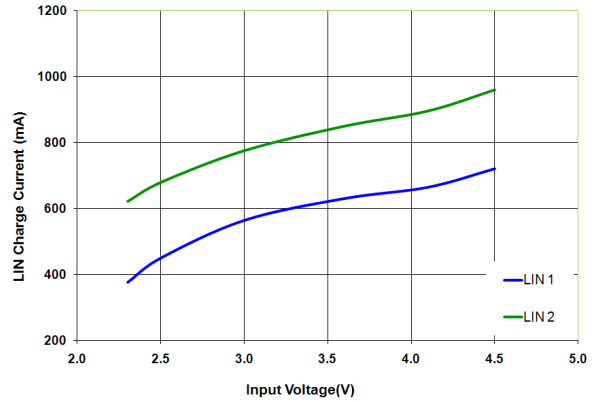
**Figure 46. Fault Response into Short Circuit**

The fault clock period as a function of  $V_{IN}$  is shown in Figure 47.



**Figure 47. Fault Clock Period vs.  $V_{IN}$**

The  $V_{IN}$ -dependent LIN Mode charging current is illustrated in Figure 48.



**Figure 48. LIN Mode Current vs.  $V_{IN}$**

**Over-Temperature Protection (OTP)**

The regulator shuts down when the thermal shutdown threshold is reached. Restart, with soft-start, occurs when the IC has cooled by about 30°C.

**Over-Current Protection (OCP)**

During Boost Mode, the FAN4860 employs a cycle-by-cycle peak current limit to protect switching elements. Sustained current limit, for 32 consecutive fault clock counts, initiates a fault condition.

During an overload condition, as  $V_{OUT}$  collapses to approximately  $V_{IN}-1$  V, the synchronous rectifier is immediately switched off and a fault condition is declared.

Automatic restart occurs once the overload/short is removed and the fault timer completes counting.

APPLICATION INFORMATION

External Component Selection

Table 8 shows the recommended external components for the FAN4860:

Table 8. EXTERNAL COMPONENTS

REF	Description	Manufacturer
L1	1.0 μH, 0.8 A, 190 mΩ, 0805	Murata LQM21PN1R0MC0, or equivalent
C <sub>IN</sub>	2.2 μF, 6.3 V, X5R, 0402	Murata GRM155R60J225M
		TDK C1005X5R0J225M
C <sub>OUT</sub>	4.7 μF, 10 V, X5R, 0603 (Note 5)	Kemet C0603C475K8PAC
		TDK C1608X5R1A475K

5. A 6.3 V-rated 0603 capacitor may be used for C<sub>OUT</sub>, such as Murata GRM188R60J225M. All datasheet parameters are valid with the 6.3 V-rated capacitor. Due to DC bias effects, the 10 V capacitor offers a performance enhancement; particularly output ripple and transient response, without any size increase.

Output Capacitance (C<sub>OUT</sub>)

Stability

The effective capacitance (C<sub>EFF</sub>) of small, high-value, ceramic capacitors decrease as their bias voltage increases, as shown in Figure 49.

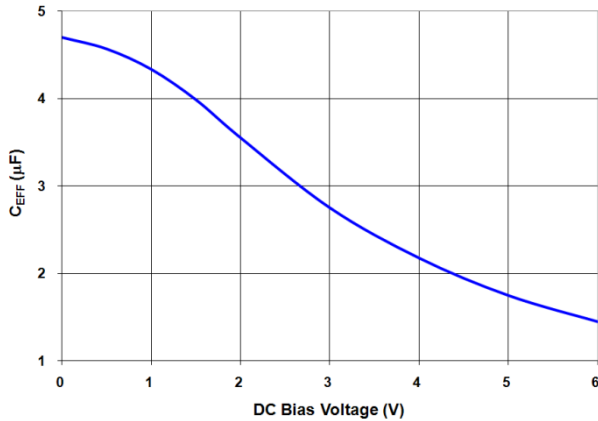


Figure 49. C<sub>EFF</sub> for 4.7 μF, 0603, X5R, 6.3 V (Murata GRM188R60J475K)

FAN4860 is guaranteed for stable operation with the minimum value of C<sub>EFF</sub> (C<sub>EFF(MIN)</sub>) outlined in Table 9.

Table 9. MINIMUM C<sub>EFF</sub> REQUIRED FOR STABILITY

Operating Conditions		C <sub>EFF(MIN)</sub> (μF)
V <sub>IN</sub> (V)	I <sub>LOAD</sub> (mA)	
2.3 to 4.5	0 to 200	1.5
2.7 to 4.5	0 to 200	1.0
2.3 to 4.5	0 to 150	1.0

C<sub>EFF</sub> varies with manufacturer, dielectric material, case size, and temperature. Some manufacturers may be able to provide an X5R capacitor in 0402 case size that retains C<sub>EFF</sub> > 1.5 μF with 5 V bias; others may not. If this C<sub>EFF</sub> cannot be economically obtained and 0402 case size is required, the IC can work with the 0402 capacitor as long as the minimum V<sub>IN</sub> is restricted to > 2.7 V.

For best performance, a 10 V-rated 0603 output capacitor is recommended (Kemet C0603C475K8PAC, or equivalent). Since it retains greater C<sub>EFF</sub> under bias and over temperature, output ripple can be reduced and transient capability enhanced.

Output Voltage Ripple

Output voltage ripple is inversely proportional to C<sub>OUT</sub>. During t<sub>ON</sub>, when the boost switch is on, all load current is supplied by C<sub>OUT</sub>.

$$V_{\text{RIPPLE(P-P)}} = t_{\text{ON}} \times \frac{I_{\text{LOAD}}}{C_{\text{OUT}}} \quad (\text{eq. 4})$$

and

$$t_{\text{ON}} = t_{\text{SW}} \times D = t_{\text{SW}} \times \left(1 - \frac{V_{\text{IN}}}{V_{\text{OUT}}}\right) \quad (\text{eq. 5})$$

Therefore:

$$V_{\text{RIPPLE(P-P)}} = t_{\text{SW}} \times \left(1 - \frac{V_{\text{IN}}}{V_{\text{OUT}}}\right) \times \frac{I_{\text{LOAD}}}{C_{\text{OUT}}} \quad (\text{eq. 6})$$

Where:

$$t_{\text{SW}} = \frac{1}{f_{\text{SW}}} \quad (\text{eq. 7})$$

As can be seen from Equation 6, the maximum V<sub>RI</sub>PPLE occurs when V<sub>IN</sub> is minimum and I<sub>LOAD</sub> is maximum.

Startup

Input current limiting is in effect during soft-start, which limits the current available to charge C<sub>OUT</sub>. If the output fails to achieve regulation within the time period described in the soft-start section above; a FAULT occurs, causing the circuit to shut down, then restart after a significant time period. If C<sub>OUT</sub> is a very high value, the circuit may not start on the first attempt, but eventually achieves regulation if no load is present. If a high-current load and high capacitance are both present during soft-start, the circuit may fail to achieve regulation and continually attempt soft-start, only to have C<sub>OUT</sub> discharged by the load when in the FAULT state.

The circuit can start with higher values of C<sub>OUT</sub> under full load if V<sub>IN</sub> is higher, since:

$$I_{\text{OUT}} = \left(I_{\text{LIM(PK)}} - \frac{I_{\text{RIPPLE}}}{2}\right) \times \frac{V_{\text{IN}}}{V_{\text{OUT}}} \quad (\text{eq. 8})$$

Generally, the limitation occurs in BST Mode.

## FAN4860

The FAN4860 starts on the first pass (without triggering a FAULT) under the following conditions for  $C_{EFF(MAX)}$ :

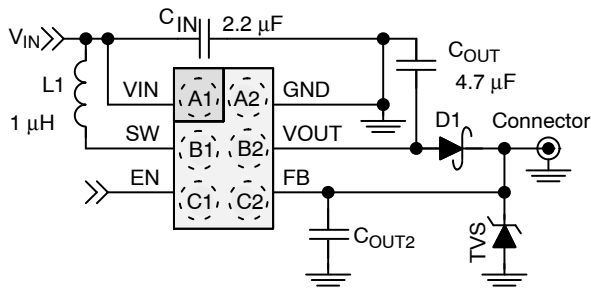
**Table 10. MAXIMUM  $C_{EFF}$  FOR FIRST-PASS STARTUP**

Operating Conditions				$C_{EFF(MAX)}$ ( $\mu F$ )
$V_{IN}$ (V)	$R_{LOAD(MIN)}$ ( $\Omega$ )			
	$5.4 V_{OUT}$	$5.0 V_{OUT}$	$3.3 V_{OUT}$	
> 2.3	27	25	16	10
> 2.7	27	25	16	15
> 2.7	37	33	20	22

$C_{EFF}$  values shown in Table 10 typically apply to the lowest  $V_{IN}$ . The presence of higher  $V_{IN}$  enhances ability to start into larger  $C_{EFF}$  at full load.

### Transient Protection

To protect against external voltage transients caused by ESD discharge events, or improper external connections, some applications employ an external transient voltage suppressor (TVS) and Schottky diode (D1 in Figure 50).



**Figure 50. FAN4860 with External Transient Protection**

The TVS is designed to clamp the FB line (system  $V_{OUT}$ ) to +10 V or -2 V during external transient events. The Schottky diode protects the output devices from the positive excursion. The FB pin can tolerate up to 14 V of positive excursion, while both the FB and  $V_{OUT}$  pins can tolerate negative voltages.

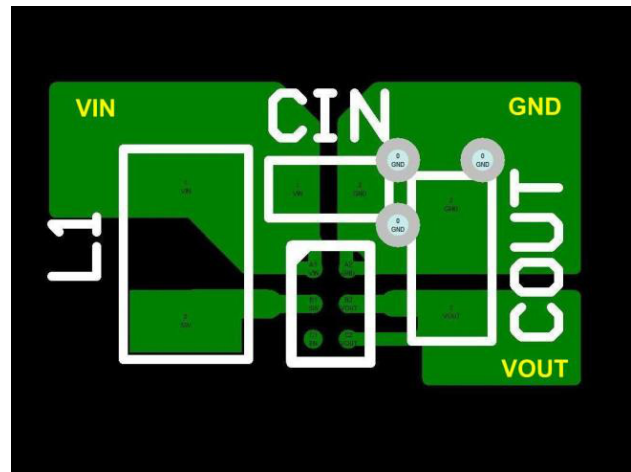
The FAN4860 includes a circuit to detect a missing or defective D1 by comparing  $V_{OUT}$  to FB. If  $V_{OUT} - FB >$  about 0.7 V, the IC shuts down. The IC remains shut down until  $V_{OUT} < UVLO$  and  $V_{IN} < UVLO + 0.7$  or EN is toggled.

$C_{OUT2}$  may be necessary to preserve load transient response when the Schottky is used. When a load is applied

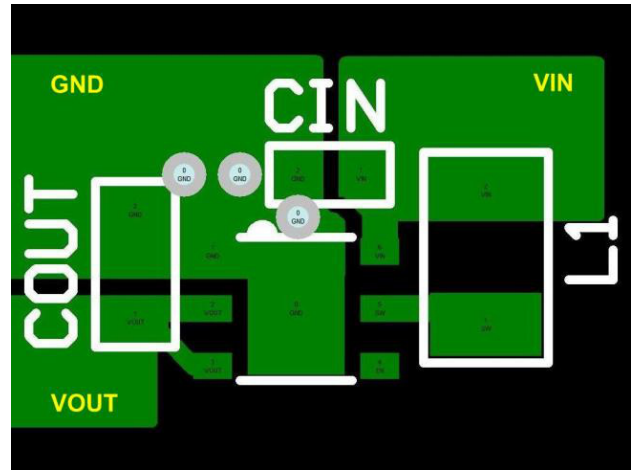
at the FB pin, the forward voltage of the D1 rapidly increases before the regulator can respond or the inductor current can change. This causes an immediate drop of up to 300 mV, depending on D1's characteristics if  $C_{OUT2}$  is absent.  $C_{OUT2}$  supplies instantaneous current to the load while the regulator adjusts the inductor current. A value of at least half of the minimum value of  $C_{OUT}$  should be used for  $C_{OUT2}$ .  $C_{OUT2}$  needs to withstand the maximum voltage at the FB pin as the TVS is clamping.

The maximum DC output current available is reduced with this circuit, due to the additional dissipation of D1.

### LAYOUT GUIDELINE



**Figure 51. WLCSP Suggested Layout (Top View)**



**Figure 52. UMLP Suggested Layout (Top View)**

### PRODUCT-SPECIFIC DIMENSIONS

Product	D	E	X	Y
FAN4860UC5X	1.230mm $\pm$ 0.030 mm	0.880 mm $\pm$ 0.030 mm	0.240 mm	0.215 mm
FAN4860UC33X				

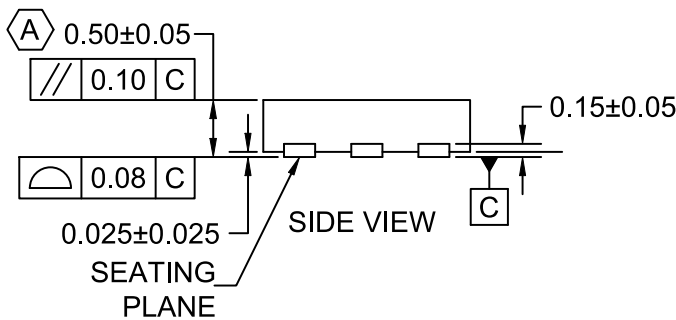
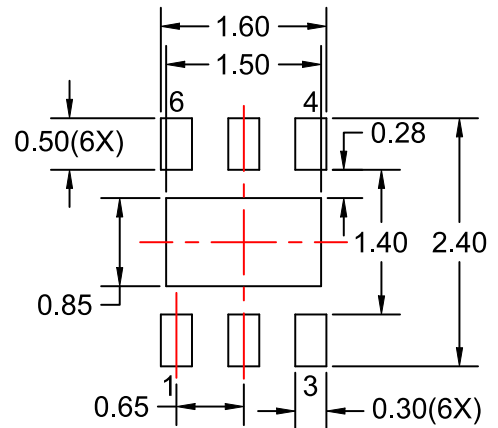
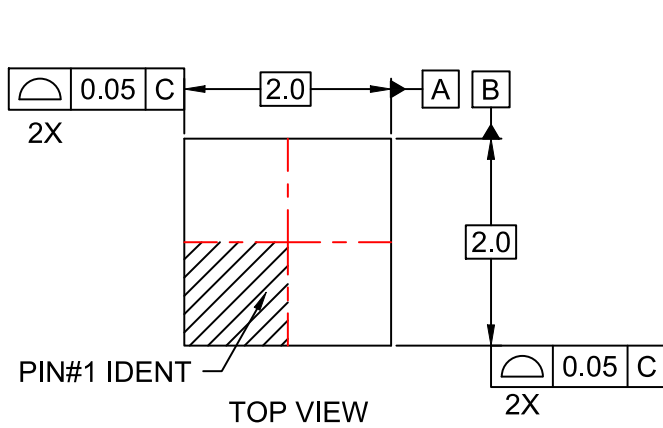
TINYBOOST is registered trademarks of Semiconductor Components Industries, LLC (SCILLC) or its subsidiaries in the United States and/or other countries.





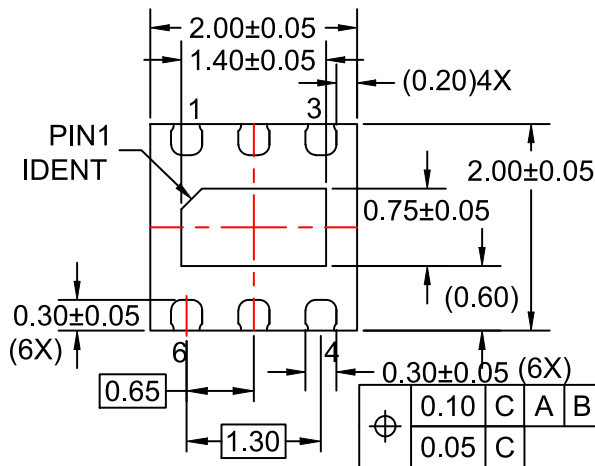
**UDFN6 2x2, 0.65P**  
CASE 517DS  
ISSUE O

DATE 31 OCT 2016



**NOTES:**

- A. CONFORM TO JADEC REGISTRATIONS MO-229, VARIATION VCCC, EXCEPT WHERE NOTED.
- B. DIMENSIONS ARE IN MILLIMETERS.
- C. DIMENSIONS AND TOLERANCES PER ASME Y14.5M, 2009.
- D. LAND PATTERN RECOMMENDATION IS EXISTING INDUSTRY LAND PATTERN.



**BOTTOM VIEW**

<b>DOCUMENT NUMBER:</b>	<b>98AON13697G</b>	Electronic versions are uncontrolled except when accessed directly from the Document Repository. Printed versions are uncontrolled except when stamped "CONTROLLED COPY" in red.
<b>DESCRIPTION:</b>	<b>UDFN6 2x2, 0.65P</b>	<b>PAGE 1 OF 1</b>

ON Semiconductor and are trademarks of Semiconductor Components Industries, LLC dba ON Semiconductor or its subsidiaries in the United States and/or other countries. ON Semiconductor reserves the right to make changes without further notice to any products herein. ON Semiconductor makes no warranty, representation or guarantee regarding the suitability of its products for any particular purpose, nor does ON Semiconductor assume any liability arising out of the application or use of any product or circuit, and specifically disclaims any and all liability, including without limitation special, consequential or incidental damages. ON Semiconductor does not convey any license under its patent rights nor the rights of others.

# MECHANICAL CASE OUTLINE

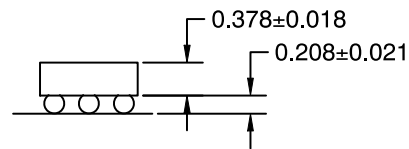
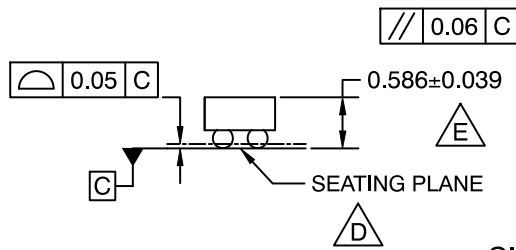
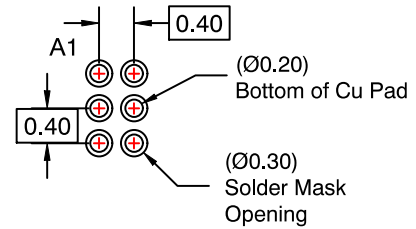
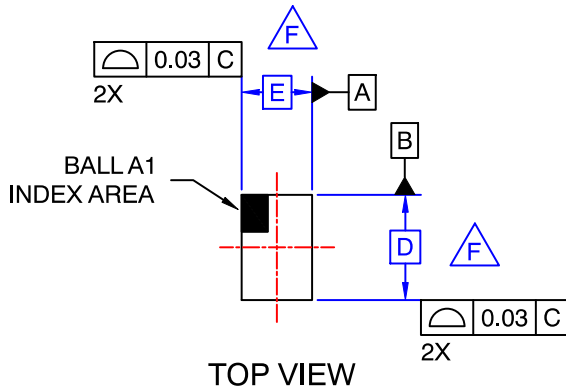
## PACKAGE DIMENSIONS

ON Semiconductor®



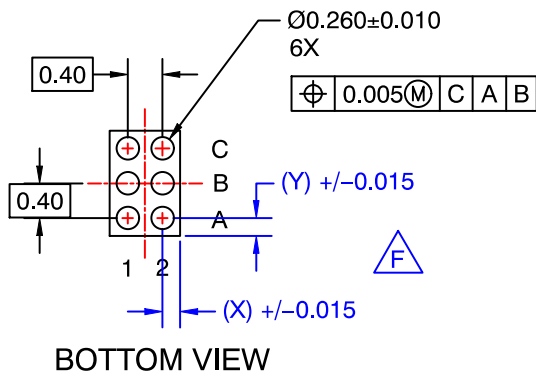
WLCSP6 1.23x0.88x0.586  
CASE 567RP  
ISSUE O

DATE 30 NOV 2016



### NOTES:

- A. NO JEDEC REGISTRATION APPLIES.
- B. DIMENSIONS ARE IN MILLIMETERS.
- C. DIMENSIONS AND TOLERANCES PER ASMEY14.5M, 2009.
- D. DATUM C, THE SEATING PLANE IS DEFINED BY THE SPHERICAL CROWNS OF THE BALLS.
- E. PACKAGE TYPICAL HEIGHT IS 586 MICRONS ±39 MICRONS (547–625 MICRONS).
- F. FOR DIMENSIONS D, E, X, AND Y, SEE PRODUCT DATASHEET.



<b>DOCUMENT NUMBER:</b>	<b>98AON16582G</b>	Electronic versions are uncontrolled except when accessed directly from the Document Repository. Printed versions are uncontrolled except when stamped "CONTROLLED COPY" in red.
<b>DESCRIPTION:</b>	<b>WLCSP6 1.23x0.88x0.586</b>	<b>PAGE 1 OF 1</b>

ON Semiconductor and are trademarks of Semiconductor Components Industries, LLC dba ON Semiconductor or its subsidiaries in the United States and/or other countries. ON Semiconductor reserves the right to make changes without further notice to any products herein. ON Semiconductor makes no warranty, representation or guarantee regarding the suitability of its products for any particular purpose, nor does ON Semiconductor assume any liability arising out of the application or use of any product or circuit, and specifically disclaims any and all liability, including without limitation special, consequential or incidental damages. ON Semiconductor does not convey any license under its patent rights nor the rights of others.

**onsemi**, **Onsemi**, and other names, marks, and brands are registered and/or common law trademarks of Semiconductor Components Industries, LLC dba "**onsemi**" or its affiliates and/or subsidiaries in the United States and/or other countries. **onsemi** owns the rights to a number of patents, trademarks, copyrights, trade secrets, and other intellectual property. A listing of **onsemi**'s product/patent coverage may be accessed at [www.onsemi.com/site/pdf/Patent-Marking.pdf](http://www.onsemi.com/site/pdf/Patent-Marking.pdf). **onsemi** reserves the right to make changes at any time to any products or information herein, without notice. The information herein is provided "as-is" and **onsemi** makes no warranty, representation or guarantee regarding the accuracy of the information, product features, availability, functionality, or suitability of its products for any particular purpose, nor does **onsemi** assume any liability arising out of the application or use of any product or circuit, and specifically disclaims any and all liability, including without limitation special, consequential or incidental damages. Buyer is responsible for its products and applications using **onsemi** products, including compliance with all laws, regulations and safety requirements or standards, regardless of any support or applications information provided by **onsemi**. "Typical" parameters which may be provided in **onsemi** data sheets and/or specifications can and do vary in different applications and actual performance may vary over time. All operating parameters, including "Typicals" must be validated for each customer application by customer's technical experts. **onsemi** does not convey any license under any of its intellectual property rights nor the rights of others. **onsemi** products are not designed, intended, or authorized for use as a critical component in life support systems or any FDA Class 3 medical devices or medical devices with a same or similar classification in a foreign jurisdiction or any devices intended for implantation in the human body. Should Buyer purchase or use **onsemi** products for any such unintended or unauthorized application, Buyer shall indemnify and hold **onsemi** and its officers, employees, subsidiaries, affiliates, and distributors harmless against all claims, costs, damages, and expenses, and reasonable attorney fees arising out of, directly or indirectly, any claim of personal injury or death associated with such unintended or unauthorized use, even if such claim alleges that **onsemi** was negligent regarding the design or manufacture of the part. **onsemi** is an Equal Opportunity/Affirmative Action Employer. This literature is subject to all applicable copyright laws and is not for resale in any manner.

## ADDITIONAL INFORMATION

### TECHNICAL PUBLICATIONS:

Technical Library: [www.onsemi.com/design/resources/technical-documentation](http://www.onsemi.com/design/resources/technical-documentation)  
onsemi Website: [www.onsemi.com](http://www.onsemi.com)

### ONLINE SUPPORT: [www.onsemi.com/support](http://www.onsemi.com/support)

For additional information, please contact your local Sales Representative at [www.onsemi.com/support/sales](http://www.onsemi.com/support/sales)