

FAN5308

800mA High-Efficiency Step-Down DC-DC Converter

Features

- 96% efficiency, synchronous operation
- Adjustable output voltage options from 0.8V to V_{IN}
- 2.5V to 5.5V input voltage range
- Up to 800mA output current
- Fixed-frequency 1.3MHz PWM operation
- High-efficiency, power-save mode
- 100% duty cycle low-dropout operation
- Soft-start
- Output over-voltage protection
- Dynamic output voltage positioning
- 25 μ A quiescent current
- Thermal shutdown and short-circuit protection
- Pb-free 3x3mm 6-lead MLP package

Applications

- Pocket PCs, PDAs
- Cell phones
- Battery-powered portable devices
- Digital cameras
- Hard disk drives
- Set-top boxes
- Point-of-load power
- Notebook computers
- Communications equipment

Description

Designed for use in battery-powered applications, the FAN5308 is a high-efficiency, low-noise synchronous PWM current mode and pulse skip (power-save) mode DC-DC converter. It can provide up to 800mA of output current over an input range from 2.5V to 5.5V. The output voltage can be externally adjusted over a range of 0.8V to 5.5V by means of an external voltage divider.

At moderate and light loads, pulse skipping modulation is used. Dynamic voltage positioning is applied and the output voltage is shifted 0.8% above nominal value for increased headroom during load transients. At higher loads, the system automatically switches over to current mode PWM control, operating at 1.3MHz. A current mode control loop with fast transient response ensures excellent line and load regulation. To achieve high efficiency and ensure long battery life, the quiescent current is reduced to 25 μ A in power-save mode, and the supply current drops below 1 μ A in shut-down mode. The FAN5308 is available in a 3x3mm 6-lead MLP package.

Ordering Information

Product Number	Output Voltage	Package Type	Order Code
FAN5308	Adjustable	3x3mm 6-Lead MLP	FAN5308MPX

Typical Application

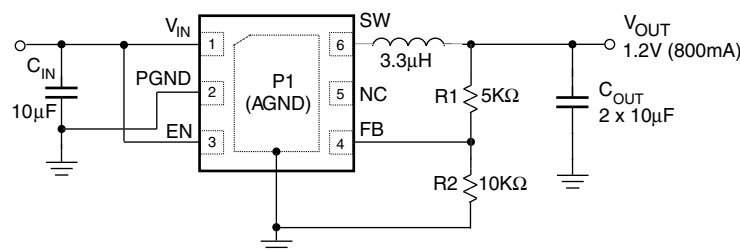

Figure 1. Typical Application

Pin Configuration

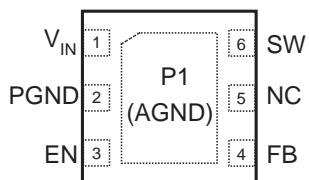

Figure 2. Pin Assignment for 3x3mm 6-Lead MLP

Pin Description

Pin #	Name	Description
P1	AGND	Analog Ground. P1 must be soldered to the PCB ground.
1	V_{IN}	Supply Voltage Input.
2	PGND	Power Ground. This pin is connected to the internal MOSFET switches. This pin must be externally connected to AGND.
3	EN	Enable Input. Logic high enables the chip and logic low disables the chip, reducing the supply current to less than 1 μ A. Do not float this pin.
4	FB	Feedback Input. Adjustable voltage option, connect this pin to the resistor divider.
5	NC	No Connection Pin.
6	SW	Switching Node. This pin is connected to the internal MOSFET switches.

Absolute Maximum Ratings

Stresses exceeding the absolute maximum ratings may damage the device. The device may not function or be operable above the recommended operating conditions and stressing the parts to these levels is not recommended. In addition, extended exposure to stresses above the recommended operating conditions may affect device reliability. The absolute maximum ratings are stress ratings only.

Parameter	Min.	Max.	Unit
V_{IN}	-0.3	7.0	V
Voltage On Any Other Pin	-0.3	V_{IN}	V
Lead Soldering Temperature (10 seconds)		260	°C
Junction Temperature		150	°C
Storage Temperature	-65	150	°C
Thermal Resistance, Junction-to-Case (θ_{JC}), 3x3mm 6-lead MLP ⁽¹⁾		8	°C/W
Electrostatic Discharge Protection (ESD) Level ⁽²⁾	HBM	4	kV
	CDM	1	

Notes:

1. Junction-to-ambient thermal resistance, θ_{JA} , is a strong function of PCB material, board thickness, thickness and number of copper planes, number of via used, diameter of via used, available copper surface, and attached heat sink characteristics.
2. Using Mil Std. 883E, method 3015.7 (Human Body Model) and EIA/JESD22C101-A (Charged Device Model).

Recommended Operating Conditions

The Recommended Operating Conditions table defines the conditions for actual device operation. Recommended operating conditions are specified to ensure optimal performance to the datasheet specifications. Fairchild does not recommend exceeding them or designing to absolute maximum ratings.

Parameter	Min.	Typ.	Max.	Unit
Supply Voltage Range	2.5		5.5	V
Output Voltage Range, Adjustable Version	0.8		V_{IN}	V
Output Current			800	mA
Inductor ⁽³⁾		3.3		μ H
Input Capacitor ⁽³⁾		10		μ F
Output Capacitor ⁽³⁾		2 x 10		μ F
Operating Ambient Temperature Range	-40		+85	°C
Operating Junction Temperature Range	-40		+125	°C

Note:

3. Refer to the Applications section for details.

Electrical Characteristics

$V_{IN} = V_{OUT} + 0.6V$ (minimum 2.5V) to 5.5V, $I_{OUT} = 350mA$, $V_{OUT} = 1.2V$, $EN = V_{IN}$, $T_A = -40^{\circ}C$ to $+85^{\circ}C$, unless otherwise noted. Typical values are at $T_A = 25^{\circ}C$.

Symbol	Parameter	Conditions	Min.	Typ.	Max.	Units	
V_{IN}	Input Voltage	$0 mA \leq I_{OUT} \leq 800 mA$	2.5		5.5	V	
I_Q	Quiescent Current	$I_{OUT} = 0mA$, Device is not switching		20	35	μA	
		$I_{OUT} = 0mA$, Device is switching ⁽⁴⁾	$R2 = 10k\Omega$		50		μA
			$R2 = 100k\Omega$		25		μA
I_{SD}	Shutdown Supply Current	$EN = GND$		0.1	1.0	μA	
V_{UVLO}	Under-Voltage Lockout Threshold	V_{IN} Rising	1.9	2.1	2.3	V	
		Hysteresis		150		mV	
V_{ENH}	Enable High Input Voltage		1.3			V	
V_{ENL}	Enable Low Input Voltage				0.4	V	
I_{EN}	EN Input Bias Current	$EN = V_{IN}$ or GND		0.01	0.10	μA	
R_{DS-ON}	PMOS On Resistance	$V_{IN} = V_{GS} = 5.5V$		250	350	m Ω	
		$V_{IN} = V_{GS} = 2.5V$		300	400		
	NMOS On Resistance	$V_{IN} = V_{GS} = 5.5V$		200	300	m Ω	
		$V_{IN} = V_{GS} = 2.5V$		250	350		
I_{LIM}	P-channel Current Limit	$2.5V < V_{IN} < 5.5V$	1300	1500	2000	mA	
f_{OSC}	Oscillator Frequency		1000	1300	1500	KHz	
I_{lkg_N}	N-Channel Leakage Current	$V_{DS} = 5.5V$		0.1	1	μA	
I_{lkg_P}	P-Channel Leakage Current	$V_{DS} = 5.5V$		0.1	1	μA	
	Line Regulation	$I_{OUT} = 10mA$		0.16		%/V	
	Load Regulation	$350mA \leq I_{OUT} \leq 800mA$		0.15		%	
V_{REF}	Reference Voltage			0.8		V	
	Output DC Voltage Accuracy ⁽⁵⁾	$0mA \leq I_{OUT} \leq 800mA$	-3		+3	%	
	Over-Temperature Protection	PWM Mode Only $350mA \leq I_{OUT} \leq 800mA$	Rising Temperature		150		$^{\circ}C$
			Hysteresis		20		$^{\circ}C$
t_{ST}	Start-Up Time	$I_{OUT} = 800mA$, $C_{OUT} = 20\mu F$		800		μs	

Notes:

- Refer to the Application section for details.
- For output voltages $\leq 1.2V$, a $40\mu F$ output capacitor value is required to achieve a maximum output accuracy of 3% while operating in power-save mode (PFM mode).

Typical Performance Characteristics

$T_A = 25^\circ\text{C}$, $C_{IN} = 10\mu\text{F}$, $C_{OUT} = 20\mu\text{F}$, $L = 3.3\mu\text{H}$, $R_2 = 10\text{k}\Omega$, unless otherwise noted.

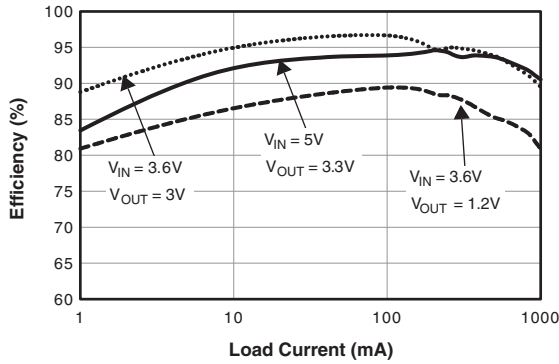

Figure 3. Efficiency vs. Load Current

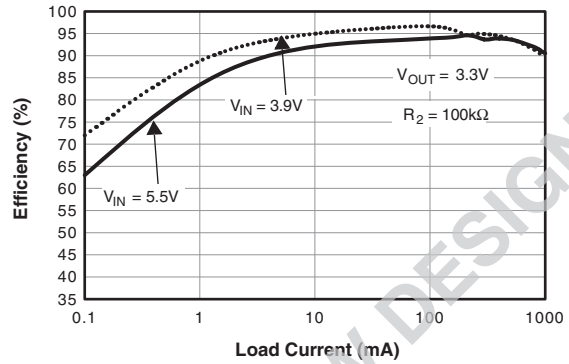

Figure 4. Efficiency vs. Load Current

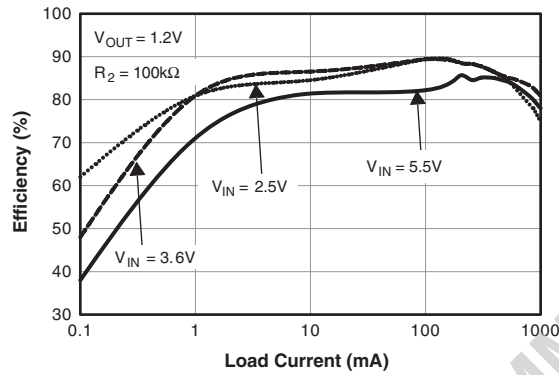

Figure 5. Efficiency vs. Load Current

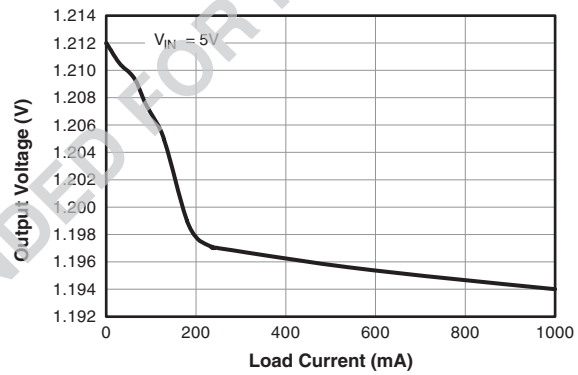

Figure 6. Output Voltage vs. Load Current

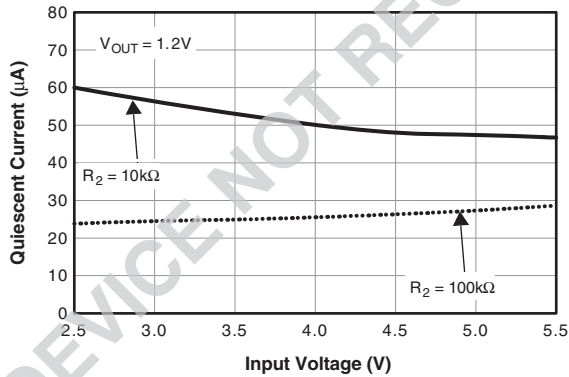

Figure 7. Quiescent Current vs. Input Voltage

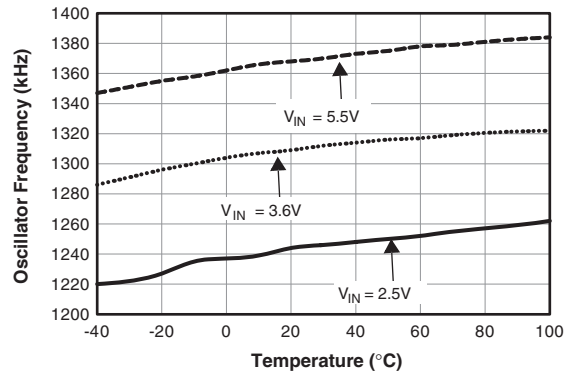

Figure 8. Frequency vs. Temperature

Typical Performance Characteristics (Continued)

$T_A = 25^\circ\text{C}$, $C_{IN} = 10\mu\text{F}$, $C_{OUT} = 20\mu\text{F}$, $L = 3.3\mu\text{H}$, $R_2 = 10\text{k}\Omega$, unless otherwise noted.

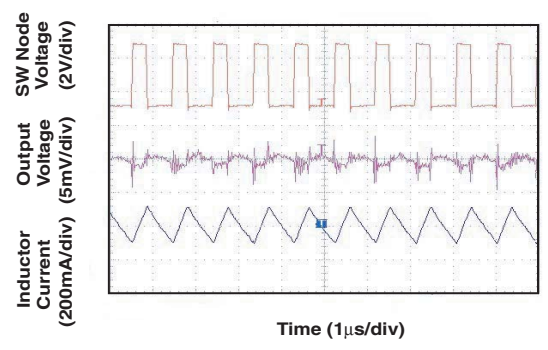

Figure 9. PWM Mode

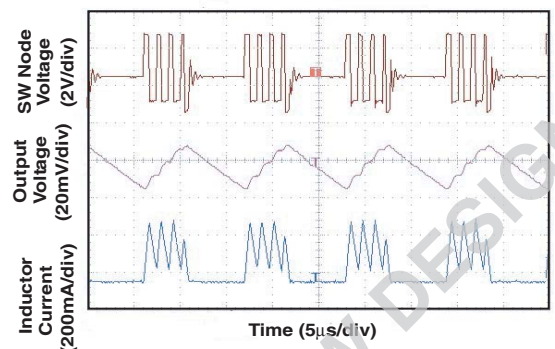

Figure 10. Power-Save Mode

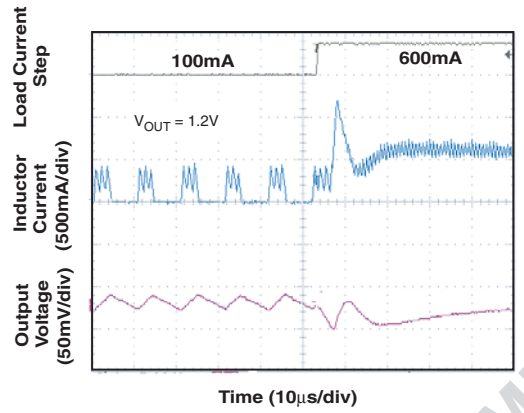

Figure 11. Load Transient Response

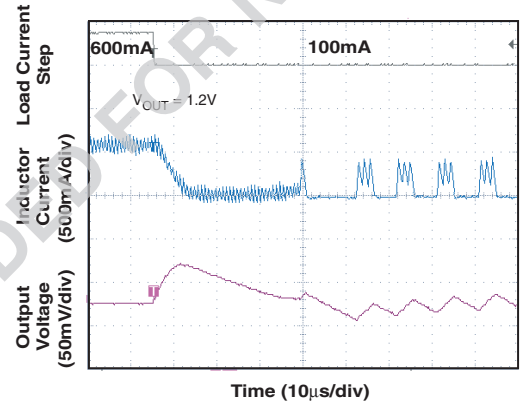

Figure 12. Load Transient Response

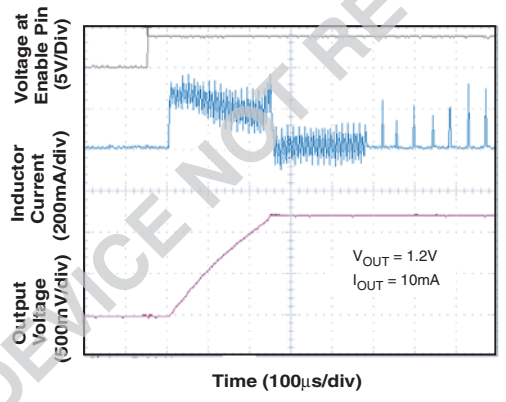

Figure 13. Start-Up Response

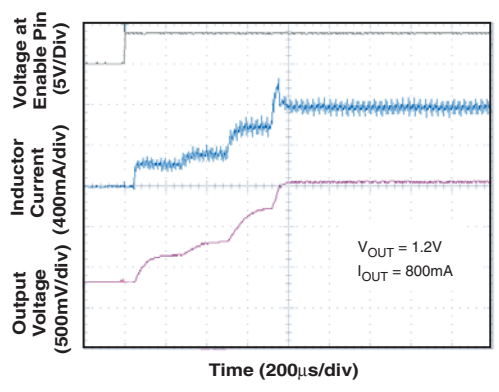

Figure 14. Start-Up Response

Block Diagram

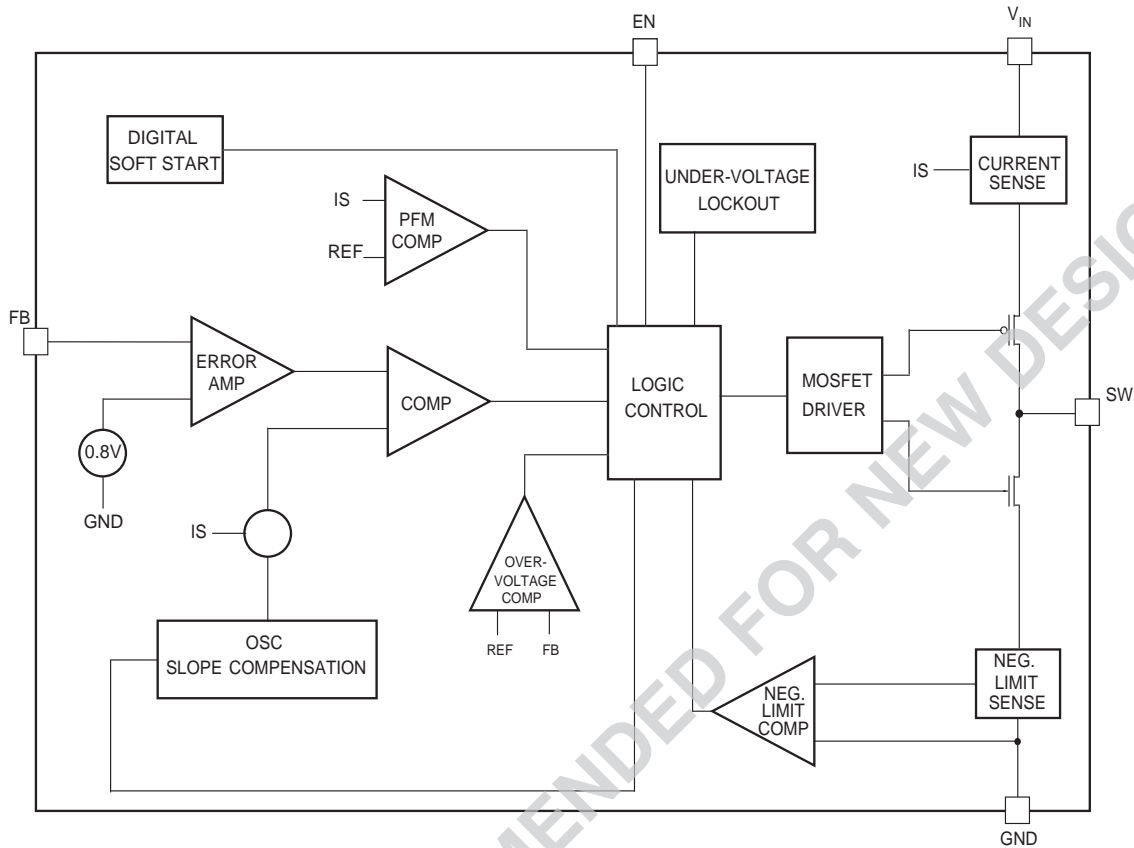

Figure 15. Block Diagram

Detailed Operation Description

The FAN5308 is a step-down converter operating in a current-mode PFM/PWM architecture with a typical switching frequency of 1.3MHz. At moderate to heavy loads, the converter operates in pulse-width-modulation (PWM) mode. At light loads, the converter enters a power-save mode (PFM pulse skipping) to keep the efficiency high.

PWM Mode

In PWM mode, the device operates at a fixed frequency of 1.3MHz. At the beginning of each clock cycle, the P-channel transistor is turned on. The inductor current ramps up and is monitored via an internal circuit. The P-channel switch is turned off when the sensed current causes the PWM comparator to trip when the output voltage is in regulation or when the inductor current reaches the current limit (set internally to typically 1500mA). After a minimum dead time, the N-channel transistor is turned on and the inductor current ramps down. As the clock cycle is completed, the N-channel switch is turned off and the next clock cycle starts.

PFM (Power-Save) Mode

As the load current decreases and the inductor current reaches negative value, the converter enters pulse-frequency-modulation (PFM) mode. The transition point for the PFM mode is given by the equation:

$$I_{OUT} = V_{OUT} \times \frac{1 - (V_{OUT}/V_{IN})}{2 \times L \times f} \quad \text{EQ. 1}$$

The typical output current, when the device enters PFM mode, is 150mA for input voltage of 3.6V and output voltage of 1.2V. In PFM mode, the device operates with a variable frequency and constant peak current, thus reducing the quiescent current to minimum. Consequently, the high efficiency is maintained at light loads. As soon as the output voltage falls below a threshold, set at 0.8% above the nominal value, the P-channel transistor is turned on and the inductor current ramps up. The P-channel switch turns off and the N-channel turns on as the peak inductor current is reached (typical 450mA).

The N-channel transistor is turned off before the inductor current becomes negative. At this time, the P-channel is switched on again, starting the next pulse. The converter continues these pulses until the high threshold (typical 1.6% above nominal value) is reached. A higher output voltage in PFM mode gives additional headroom for the voltage drop during a load transient from light to full load. The voltage overshoot during this load transient is also minimized due to active regulation during turn on of the N-channel rectifier switch. The device stays in sleep mode until the output voltage falls below the low threshold. The FAN5308 enters the PWM mode as soon as the output voltage can no longer be regulated in PFM with constant peak current.

100% Duty Cycle Operation

As the input voltage approaches the output voltage and the duty cycle exceeds the typical 95%, the converter turns the P-channel transistor continuously on. In this mode, the output voltage is equal to the input voltage, minus the voltage drop across the P-channel transistor:

$$V_{OUT} = V_{IN} - I_{LOAD} \times (R_{dsON} + R_L) \quad \text{EQ. 2}$$

where:

R_{dsON} = P-channel switch on resistance

I_{LOAD} = Output current

R_L = Inductor DC resistance

UVLO and Soft Start

The reference and the circuit remain reset until the V_{IN} crosses its UVLO threshold.

The FAN5308 has an internal soft-start circuit that limits the inrush current during start-up. This prevents possible voltage drops of the input voltage and eliminates the output voltage overshoot. The soft-start is implemented as a digital circuit, increasing the switch current in four steps to the P-channel current limit (1500mA). Typical start-up time for a 20 μ F output capacitor and a load current of 800mA is 800 μ s.

Short-Circuit Protection

The switch peak current is limited cycle-by-cycle to a typical value of 1500mA. In the event of an output voltage short circuit, the device operates with a frequency of 400kHz and minimum duty cycle; therefore, the average input current is typically 200mA.

Thermal Shutdown

When the die temperature exceeds 150°C, a reset occurs and remains in effect until the die cools to 130°C. At that time, the circuit is allowed to restart.

Applications Information

Setting the Output Voltage

The internal reference is 0.8V (typical). The output voltage is divided by a resistor divider, R1 and R2 to the FB pin. The output voltage is given by:

$$V_{OUT} = V_{REF} \times \left(1 + \left(\frac{R1}{R2}\right)\right) \quad \text{EQ. 3}$$

where $R_1 + R_2 < 800K\Omega$.

According to this equation, and assuming desired output voltage of 1.5096V, and given $R_2 = 10k\Omega$, the calculated value of R1 is 8.87k Ω . If quiescent current is a key design parameter, a higher value feedback resistor can be used (e.g. $R_2 = 100k\Omega$) and a small bypass capacitor of 10pF is required in parallel with the upper resistor, as shown in Figure 16.

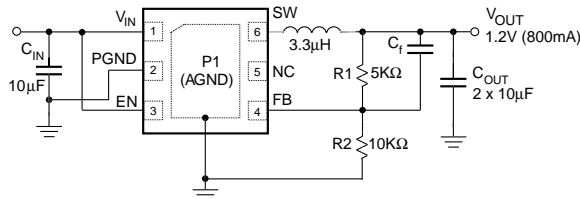

Figure 16. Setting the Output Voltage

Inductor Selection

The inductor parameters directly related to the device's performances are saturation current and DC resistance. The FAN5308 operates with a typical inductor value of 3.3µH. The lower the DC resistance, the higher the efficiency. For saturation current, the inductor should be rated higher than the maximum load current plus half of the inductor ripple current.

This is calculated as follows:

$$\Delta I_L = V_{OUT} \times \frac{1 - (V_{OUT}/V_{IN})}{L \times f} \quad \text{EQ. 4}$$

where:

ΔI_L = Inductor Ripple Current

f = Switching Frequency

L = Inductor Value

Inductor Value	Vendor	Part Number
3.3µH	Panasonic	ELL6PM3R3N
3.3µH	Murata	LQS66C3R3M04

Table 1: Recommended Inductors

Capacitors Selection

For best performances, a low-ESR input capacitor is required. A ceramic capacitor of at least 10µF, placed close to the V_{IN} and AGND pins, is recommended. The output capacitor determines the output ripple and the transient response.

Capacitor Value	Vendor	Part Number
10µF	Taiyo Yuden	JMK212EJ106MG
		JMK316BJ106KL
	TDK	C2012X5ROJ106K
		C3216X5ROJ106M
Murata	GRM32ER61C106K	

Table 2: Recommended Capacitors

PCB Layout Recommendations

The recommended PCB layout is shown in Figure 17. The inherently high peak currents and switching frequency of power supplies require careful PCB layout design.

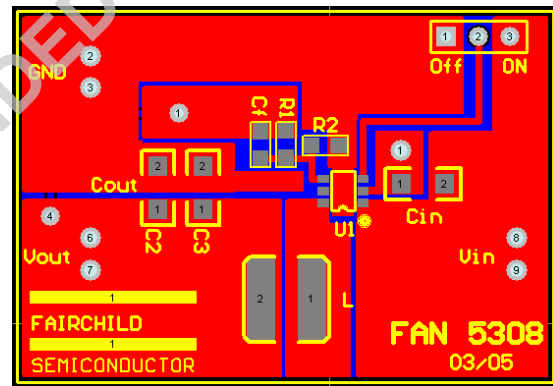

Figure 17. Recommended PCB Layout

Use wide traces for high-current paths and place the input capacitor, the inductor, and the output capacitor as close as possible to the integrated circuit terminals. To minimize voltage stress to the device resulting from ever-present switching spikes, use an input bypass capacitor with low ESR. Note that the peak amplitude of the switching spikes depends upon the load current; the higher the load current, the higher the switching spikes. The resistor divider that sets the output voltage should be routed away from the inductor to avoid RF coupling. The ground plane at the bottom side of the PCB acts as an electromagnetic shield to reduce EMI.

For more board layout recommendations, download the Fairchild application note *PCB Grounding System and FAN2001/FAN2011 High-Performance DC-DC Converters* (AN-42036).

Mechanical Dimensions

Dimensions are in millimeters unless otherwise noted.

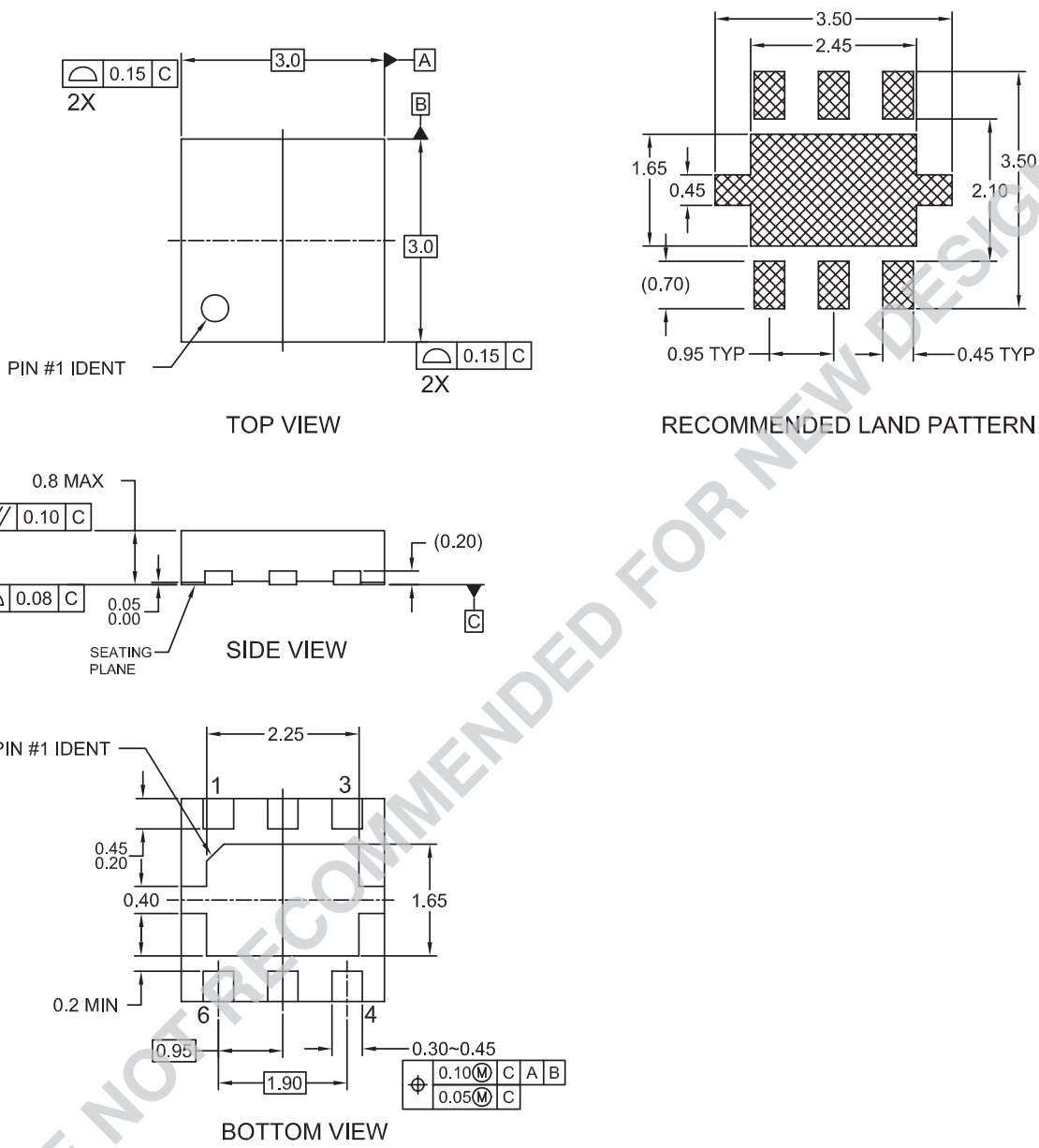

NOTES:

- A. CONFORMS TO JEDEC REGISTRATION MO-229, VARIATION WEEA, DATED 11/2001 EXCEPT FOR DAP EXTENSION TABS
- B. DIMENSIONS ARE IN MILLIMETERS.
- C. DIMENSIONS AND TOLERANCES PER ASME Y14.5M, 1994

MLP06FrevA

Figure 18. 3x3mm 6-Lead MLP



TRADEMARKS

The following are registered and unregistered trademarks and service marks Fairchild Semiconductor owns or is authorized to use and is not intended to be an exhaustive list of all such trademarks.

ACEx [®]	Green FPS [™] e-Series [™]	POWEREDGE [®]	SuperSOT [™] -8
Build it Now [™]	GTO [™]	Power-SPM [™]	SyncFET [™]
CorePLUS [™]	i-Lo [™]	PowerTrench [®]	The Power Franchise [®]
CROSSVOLT [™]	IntelliMAX [™]	Programmable Active Droop [™]	
CTL [™]	ISOPLANAR [™]	QFET [®]	TinyBoost [™]
Current Transfer Logic [™]	MegaBuck [™]	QST [™]	TinyBuck [™]
EcoSPARK [®]	MICROCOUPLER [™]	QT Optoelectronics [™]	TinyLogic [®]
FACT Quiet Series [™]	MicroFET [™]	Quiet Series [™]	TINYOPTO [™]
FACT [®]	MicroPak [™]	RapidConfigure [™]	TinyPower [™]
FAST [®]	Motion-SPM [™]	SMART START [™]	TinyPWM [™]
FastvCore [™]	OPTOLOGIC [®]	SPM [®]	TinyWire [™]
FPS [™]	OPTOPLANAR [®]	STEALTH [™]	μSerDes [™]
FRFET [®]	PDP-SPM [™]	SuperFET [™]	UHC [®]
Global Power Resource SM	Power220 [®]	SuperSOT [™] -3	UniFET [™]
Green FPS [™]	Power247 [®]	SuperSOT [™] -6	VCX [™]

DISCLAIMER

FAIRCHILD SEMICONDUCTOR RESERVES THE RIGHT TO MAKE CHANGES WITHOUT FURTHER NOTICE TO ANY PRODUCTS HEREIN TO IMPROVE RELIABILITY, FUNCTION, OR DESIGN. FAIRCHILD DOES NOT ASSUME ANY LIABILITY ARISING OUT OF THE APPLICATION OR USE OF ANY PRODUCT OR CIRCUIT DESCRIBED HEREIN; NEITHER DOES IT CONVEY ANY LICENSE UNDER ITS PATENT RIGHTS, NOR THE RIGHTS OF OTHERS. THESE SPECIFICATIONS DO NOT EXPAND THE TERMS OF FAIRCHILD'S WORLDWIDE TERMS AND CONDITIONS, SPECIFICALLY THE WARRANTY THEREIN, WHICH COVERS THESE PRODUCTS.

LIFE SUPPORT POLICY

FAIRCHILD'S PRODUCTS ARE NOT AUTHORIZED FOR USE AS CRITICAL COMPONENTS IN LIFE SUPPORT DEVICES OR SYSTEMS WITHOUT THE EXPRESS WRITTEN APPROVAL OF FAIRCHILD SEMICONDUCTOR CORPORATION.

As used herein:

1. Life support devices or systems are devices or systems which, (a) are intended for surgical implant into the body or (b) support or sustain life, and (c) whose failure to perform when properly used in accordance with instructions for use provided in the labeling, can be reasonably expected to result in a significant injury of the user.
2. A critical component in any component of a life support device, or system whose failure to perform can be reasonably expected to cause the failure of the life support device or system, or to affect its safety or effectiveness.

PRODUCT STATUS DEFINITIONS

Definition of Terms

Datasheet Identification	Product Status	Definition
Advance Information	Formative or In Design	This datasheet contains the design specifications for product development. Specifications may change in any manner without notice.
Preliminary	First Production	This datasheet contains preliminary data; supplementary data will be published at a later date. Fairchild Semiconductor reserves the right to make changes at any time without notice to improve design.
No Identification Needed	Full Production	This datasheet contains final specifications. Fairchild Semiconductor reserves the right to make changes at any time without notice to improve design.
Obsolete	Not In Production	This datasheet contains specifications on a product that has been discontinued by Fairchild Semiconductor. The datasheet is printed for reference information only.

Rev. 129

ON Semiconductor and  are trademarks of Semiconductor Components Industries, LLC dba ON Semiconductor or its subsidiaries in the United States and/or other countries. ON Semiconductor owns the rights to a number of patents, trademarks, copyrights, trade secrets, and other intellectual property. A listing of ON Semiconductor's product/patent coverage may be accessed at www.onsemi.com/site/pdf/Patent-Marking.pdf. ON Semiconductor reserves the right to make changes without further notice to any products herein. ON Semiconductor makes no warranty, representation or guarantee regarding the suitability of its products for any particular purpose, nor does ON Semiconductor assume any liability arising out of the application or use of any product or circuit, and specifically disclaims any and all liability, including without limitation special, consequential or incidental damages. Buyer is responsible for its products and applications using ON Semiconductor products, including compliance with all laws, regulations and safety requirements or standards, regardless of any support or applications information provided by ON Semiconductor. "Typical" parameters which may be provided in ON Semiconductor data sheets and/or specifications can and do vary in different applications and actual performance may vary over time. All operating parameters, including "Typicals" must be validated for each customer application by customer's technical experts. ON Semiconductor does not convey any license under its patent rights nor the rights of others. ON Semiconductor products are not designed, intended, or authorized for use as a critical component in life support systems or any FDA Class 3 medical devices or medical devices with a same or similar classification in a foreign jurisdiction or any devices intended for implantation in the human body. Should Buyer purchase or use ON Semiconductor products for any such unintended or unauthorized application, Buyer shall indemnify and hold ON Semiconductor and its officers, employees, subsidiaries, affiliates, and distributors harmless against all claims, costs, damages, and expenses, and reasonable attorney fees arising out of, directly or indirectly, any claim of personal injury or death associated with such unintended or unauthorized use, even if such claim alleges that ON Semiconductor was negligent regarding the design or manufacture of the part. ON Semiconductor is an Equal Opportunity/Affirmative Action Employer. This literature is subject to all applicable copyright laws and is not for resale in any manner.

PUBLICATION ORDERING INFORMATION

LITERATURE FULFILLMENT:

Literature Distribution Center for ON Semiconductor
19521 E. 32nd Pkwy, Aurora, Colorado 80011 USA
Phone: 303-675-2175 or 800-344-3860 Toll Free USA/Canada
Fax: 303-675-2176 or 800-344-3867 Toll Free USA/Canada
Email: orderlit@onsemi.com

N. American Technical Support: 800-282-9855 Toll Free
USA/Canada
Europe, Middle East and Africa Technical Support:
Phone: 421 33 790 2910
Japan Customer Focus Center
Phone: 81-3-5817-1050

ON Semiconductor Website: www.onsemi.com
Order Literature: <http://www.onsemi.com/orderlit>
For additional information, please contact your local
Sales Representative